

400

papco®

**AUTOMOTIVE AND INDUSTRIAL FASTENERS
ATTACHES AUTOMOBILE ET INDUSTRIEL**



Welcome to the
papco® 400 Catalogue
Please click here to begin...

paulin®

H. Paulin & Co. Limited, Toronto, Canada



USING THIS CATALOGUE IS SIMPLE

This catalogue contains an "Index" page which will help you navigate through the catalogue.

You can access the "Index" page any time by clicking on the "PAPCO® Bolt" image at the top of any page. Once there, it's as easy as pointing and clicking at the product name, description or even page number to take you directly to that appropriate page.



You can also use Adobe® Acrobat®'s "Bookmark" tab in the navigation bar at the top of the screen.

To find a part you are looking for, you may either search for a specific part number or name by clicking on the "Search Catalogue" magnifying glass button on the "Index" page, or by clicking on Adobe® Acrobat®'s "Search" under the Edit menu. Enter the part number or word you are searching for and click on the "Find" button. Clicking on the icon again will bring up the same menu – select "Find Next" to find the next instance of the word or phrase you are looking for.



To go to the next page or previous page of the catalogue, click on the appropriate navigation bar icon illustrated here.





Since 1920, Papco has been manufacturing and merchandising quality automotive fasteners for original equipment and the aftermarket. Today there are over 12,000 items in the Papco line providing extensive coverage for all types of domestic and import vehicles and fastening applications

The company occupies over 500,000 square feet of space including 5 manufacturing facilities, 9 distribution centers plus its core distribution centre and head office located in Toronto. A leader in fastener and fitting merchandising, Papco provides innovative storage systems for efficient stocking and selling of its many products.



H. Paulin & Co. Limited is ISO 9001:2008 Certified and holds the prestigious Ford Q-1 Quality Award.

To better serve our customers, all of our distribution centers are E.D.I. compatible and data such as price lists, catalogues, etc., are available electronically.

Detailed application and specification catalogues for Wheel Parts, Frost Plugs, Body Shop Fasteners, Brass Fittings, etc., are published separately.

Depuis 1920, Papco fabrique et mets en marché des attaches de qualité pour automobiles comme équipement original et pour l'après-marché. Aujourd'hui, il existe plus de 12,000 items Papco qui offrent un très vaste choix de produits pour véhicules domestiques et importés, ainsi que pour toute sorte d'application d'attaches.

La compagnie possède une surface de 500,000 p.c. d'espace qui inclus 5 sites de fabrication, 9 centres de distribution ainsi qu'un noyau central de distribution et bureau-chef situé à Toronto.

Un chef de file dans la mise en marché de pièces et d'attaches, Papco offre un système innovateur d'entreposage pour distribuer et vendre ses nombreux produits.



H. Paulin & Cie Limitée est certifié ISO 9001:2008 et détient le prestigieux Diplôme de Qualité Ford Q-1.

Pour mieux servir nos clients, tous nos centres de distribution sont informatisés et les données tel que listes de prix et catalogues, peuvent être obtenues électroniquement.

Les catalogues d'application détaillée et les spécifications pour Pièces de Roues, Bouchons d'expansion, Attaches pour Carrosserie, Conduit de Laiton, etc., sont publiés séparément.

- VANCOUVER – 3179 Thunderbird Cres., Burnaby, B.C. V5A 3G1
Telephone (604) 421-3096 Fax (604) 421-3046
- EDMONTON – 11714-180th St., Edmonton, Alta. T5S 1N7
Telephone (780) 450-1346 Fax (780) 463-3597
- WINNIPEG – 1832C King Edward St., Winnipeg, Man. R2R 0N1
Telephone (204) 694-3802 Fax (204) 694-3804
- MONTREAL – 2590 Debray Street, Laval, QC. H7S 2J4
Telephone (450) 688-4292 Fax (450) 688-4750
- MONCTON – 159 Henri Dunant Street, Moncton, NB. E1E 1E4
Telephone (506) 857-8658 Fax (506) 857-9338



INDEX



<p>ANCHORS, Lag Bolt 39 Tapcon, Concrete 78 Sleeve 79 Wedge 79</p> <p>ANGLES, Slotted & Solid .. 50-51</p> <p>ASSORTMENTS, Garage 2-3 Utility 4-5 Master 6-8 Super Service 9</p> <p>AXLE SPINDLE NUTS 155</p> <p>BALL JOINTS, Throttle Rod .. 125</p> <p>BINS, Bolt 10-11 Bulk Fastener 13 Service 13</p> <p>BITS, Drill 176-177 6-Lobe 77 Magnetic 72-73 Power Driver 70-71 'Tapcon' Concrete 78</p> <p>BLADES Replace Scraper 107</p> <p>BODYSHOP FASTENERS .. 96-109</p> <p>BOLT-N-NUT, Gauge 123</p> <p>BOLTS, Alternator 117 Battery Hold Down 162 Battery Terminal 162 Body 92 Brake Block 132 Bumper Bar 94 Carriage 38 Cylinder Head 116 Elevator 44 Flange 93 Hex 27-32 Lag 39 Licence Plate 95 Metric Hex 24 Moulding 96 Pan, Oil 131 Plow, Grade 5 38 Rim ... see <i>current Wheel Parts Cat.</i> Spring Centre 113 Stainless Steel 164 Starter 116 Stove 62 Torque-to-yield 116 Uni-Bolts 49 Wheel (Hub) 149-154</p> <p>BRACKETS, Tail Pipe (Muffler) ... 114</p> <p>BRAKE LINES 169</p> <p>BUSHINGS, Door Hinge 111 Machinery 59</p> <p>CABINETS, Bolt-n-Nut 12 Stax-Four 9 Stax-Six 6 Tilt-Bin 13</p> <p>CABLE TIES 157</p> <p>CALIPER, Precision 123</p> <p>CAP SCREWS, Bulk 28 Grade 2 and 5 27 Grade 5 Plated 28 Grade 8 Plated 30 Metric 24 Papcolloy 32 Socket Head 40 Stainless Steel 164</p> <p>CAPS, Dust, Wheel Hubs 155 Power Steering 92 Hole Plug 107, 136 Vacuum 167</p> <p>Wheel Nut, Plastic 152</p> <p>CLAMPS, Battery Booster 161 Battery, Hold Down 162 Hose 138-139 Muffler 114 Nylon Cable 146</p> <p>CLIPS, Battery, Test 159 Glass Shop 98-99 Hitch Pin 46 Hood Prop 103 Moulding 97 Throttle Rod 125 Trim Fastener 100-102 Tubular Speed Nut 87</p> <p>CONTROLS, Push-Pull ... 140-141</p> <p>DIES and TAPS 174</p>	<p>DRAIN COCKS 117</p> <p>DRILLS and TAPS 174-175</p> <p>DRILL BITS 176-177</p> <p>EXPANSION PLUGS 118-122</p> <p>EXTRACTORS, Screw 175</p> <p>FASTENERS, Body Shop ... 96-109 Canvas 147-148 Exhaust System 115, 132 Glass Shop 98-99 Marine 163-164 Metric 21-26 Moulding 96-97 Palnut 89-90 Papcolloy 32 Pic-a-Pac 172-173 Pushnut 90 Snap 147 Stainless Steel 164 Trim 96-109 Truck and Trailer 75-76 Turn 147 Weatherstrip 102</p> <p>FAUCET, Drum 117</p> <p>FITTINGS, Brake Line 170 Drain Cock 117 Grease 171</p> <p>FLAT STEEL 50-51</p> <p>FROST PLUGS 118-121</p> <p>FUEL LINES 170</p> <p>GASKETS, Drain Plug 129</p> <p>GAUGES, Bolt-n-Nut 123 Screw Thread Pitch 175 Thickness (Feeler) 123</p> <p>GROMMETS, Anchor ... 102-103 Brass 148 PCV Valve 124 Wire 158</p> <p>GUIDES, Window channel ... 99</p> <p>HANDY-PAKS 14-23</p> <p>HOLD-DOWNS, Battery 162</p> <p>HOLDERS, Fuse 158</p> <p>HOOKS, Storage Organizer ... 146</p> <p>INSERTS, Perma-Thread .. 165-166 Sert-a-Nut 83</p> <p>KEYS, Axle 136-137 Socket Screw 23, 41 Woodruff 134</p> <p>KITS, Choke Conversion 141 Drill Bit 177 Expansion Plug 120 Grommet, Brass 148 Nutsetter 72 'O' Ring Assortment 135 Perma-Thread 165-166 Pocket Screwdriver 71 Power Driver Bit 70 Sert-a-Nut 83 Snap Ring Pliers 128 Socket Key 41-42 Speedometer Cable 141 Storage Organizer 146 Uni-Bolt 49 Wheel Parts 152</p> <p>LEADS, Test 159</p> <p>LINES, Brake Line 169 Fuel 170</p> <p>MAGNETS 148</p> <p>MECHANICS' WIRE 136</p> <p>MEGA-PAKS 20, 154</p> <p>METAL, Expanded 51 Flat 50-51</p> <p>METAL CENTRE PLUS 51</p> <p>NUTS, A-Frame Clip 93 Acorn (Cap) 36 Air Cleaner Wing 124 All-Nylon 37 Anchor Grommet 102-103 Axle Spindle 155 Battery Terminal 162 Blind Well 83 Brass 115 Castellated 31 Coupling 49 Double Thick 36, 113 Engine Stud 115</p>	<p>NUTS (cont'd.) Finished Hex 31 Finished Flange 28, 31 Finished Grade 8 30 Flange 34, 93 Heavy 31 Jack, Mirror Mounting 83 Keys, Locks 37 Licence Plate 95 Machine Screw 63 Metric 25 Mirror Mounting, Jack 83 Nylon Insert Lock 35 Nylon Insert Double .. 37, 113 Pal, Lock 89 Pal, Self-Threading 89 Panel 35 Papcolloy 32 Pozi-Lok 35 Pushnuts 90 Rim ... see <i>current Wheel Parts Cat.</i> Sert-a-Nuts 83 Speed 84, 88 Stainless Steel 164 Slotted, Thick 31 Stover, Lock 33, 34 Tensilock (Flange) 34 'U' Nuts 91 Uni-Nuts 37 Wheel (Hub) 149, 152 Wing 36</p> <p>NUTSETTERS, Magnetic 72</p> <p>'O' RINGS 135</p> <p>PERMA-THREAD, Inserts ... 165-166</p> <p>PIC-A-PAC FASTENERS ... 172-173</p> <p>PINS, Clevis 45-46 Cotter 47-48 Door Hinge 111 Hitch 43 Lynch 43 Metric 23, 25 Slotted Spring 133 Taper 137 Weld 84 Wire Lock 43</p> <p>PLIERS, Snap Ring 128</p> <p>PLUGS, Button Hole ... 107, 136 'Duo-Drain' Oil 129 E-Z Seal Oil Drain 122 E-Z Seal Expansion 122 Expansion (Frost) 118-121 Hole (Button) 107, 136 Marine, Drain 164 Oil Drain 130 Pipe 132</p> <p>PROTECTORS, Battery Term. 160</p> <p>PULLERS, Battery Term./Gear ... 159</p> <p>RETAINERS, Bolt 90 Plastic Shield 101 Screw-in 104 Throttle Rod 125</p> <p>RINGS, Snap 126-128 Universal 'O' 135</p> <p>RIVETS, Blind 80-81 Panel, Aluminum 75 Plastic 82, 104 Multi-Grip 81 Window Regulator 97</p> <p>RODS, Fully Thread, Uni-Rod ... 49 Round, Steel 50 Stainless Steel, Threaded ... 164</p> <p>SCISSORS, Utility 107</p> <p>SCRAPERS, Utility 107</p> <p>SCREWS, Brake Bleeder 170 6-Lobe Trim 77 Brass Machine ... see <i>separate cat.</i> Brass Wood ... see <i>separate cat.</i> Cap ... 24, 27, 28, 30, 32, 40, 163 Drill-X, Self-Drilling 76 Floorboard 75-76 Headlamp Adjusting ... 105-106 Lag 39 Machine 25, 63-65 Roofing/Siding 44 Sheet Metal 67-69</p>	<p>SCREWS (cont'd.) Spee-Drill 73 Socket Cap 40 Socket Set 40 Square Head Set 39 Stainless Steel 164 'Tapcon' 78 Tapping 67-69 Trim 73-75 Thread Cutting 67 Truck and Trailer 75-76 Wood, Plated Steel 66</p> <p>SCREWDRIVERS, 6-Lobe Bull Dog 77 'Loxon' Square Drive 72 Magnetic, 6 in 1 73 Magnetic, 6-Lobe 73 Pocket Kit 71</p> <p>SERT-A-NUTS 83</p> <p>SHEARS, Utility 107</p> <p>SHIELDS, Lag Bolt 39</p> <p>SHIMS, Body 111 Caster and Camber ... 110-111</p> <p>SHIMSTOCK, Brass 145 Steel 145</p> <p>SNAP RINGS 126-128</p> <p>SPRINGS, Carburetor 142 Pedal Return 142 Utility 143</p> <p>STABILIZERS, Coil Spring 112</p> <p>STEEL, Angle, Iron 50-51 Flats 50 Round Rods 50 Sheets 51 Tubular 50</p> <p>STUDS, Engine 115 Rear Wheel ... see <i>Wheel Parts Cat.</i></p> <p>TAPS and DIES 174-175</p> <p>TERMINALS, Battery 160 Wiring 156</p> <p>TESTERS, Anti-Freeze 123 Battery 161 Circuit 158</p> <p>THREADED RODS 49, 164</p> <p>THROTTLE BALL JOINTS 125</p> <p>TIES, Cable 157</p> <p>TUBING, Brake Line 169 Copper 171 Round 50 Shrink 158 Square 50 Steel 171</p> <p>TOOLS, Circuit Testers 158 Crimping 157 Fuse Puller 158 Hose Clamp 138 Magnetic Retriever 148 Magnetizer/Demagnetizer ... 148 Riving 81 Screwdrivers ... 71, 72, 73, 77 Snap Ring 128 Terminal/Gear Puller 159 Terminal/Post Cleaner 161</p> <p>VACUUM CONNECTORS 167</p> <p>WASHERS, Brass 60 Brass, Finishing 61 Copper 60 Fender 58 Fibre 58 Hardened Steel (Papcolloy) ... 32 Lock 55 Machinery 59 Metric 25 Papcolloy 32, 33, 55 Plain Steel 53 Rapid Repair 59 Rivet 80 S.A.E. Steel 54 Spacer 61 Tension 61 Tooth Lock 57 Stainless Steel 163</p> <p>WHEEL PARTS 149-152</p> <p>WIRE, Mechanics' 136</p> <p>YOKES, Clevis 45</p>
---	---	--	---

papco GARAGE ASSORTMENTS



papco Garage Assortments are available in transparent plastic containers. You can see your stock of small fasteners—it is kept neat and handy. Your work bench is clear—yet the right fastener is available when you need it.

★ **THREE COMPARTMENTS**





























★ **CLEAR PLASTIC**

- Contains popular items used in every garage every day.
- Contents are Bright Plated.
- Quantity of each item is based on popularity.
- Each assortment contains only listed items—no "odds and ends".
- Refills of individual items available from standard stock.
- You get a wide range of sizes for any repair job for a minimum investment.
- Three Plastic Compartments — speed up selection.





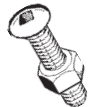



















































BRIGHT PLATED

GARAGE ASSORTMENTS

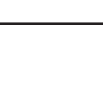
 <p>MACHINE SCREWS NO. 020-010 Round Head – Square Drive. Contains 130 Screws, 45 Nuts. 6-32 x 1/4, 3/8, 1/2, 3/4, 1", 1-1/2; Nuts 8-32 x 1/4, 3/8, 1/2, 3/4, 1", 1-1/2; Nuts 10-32 x 1/4, 3/8, 1/2, 3/4, 1", 1-1/2; Nuts Refer to page 63.</p>	 <p>THROTTLE ROD CLIPS AND RETAINERS NO. 020-022 Contains 104 pieces. 262-008, 009, 010, 011, 014, 015, 054, 056, 060, 062, 064, 073, 075, 076, 078. 262-203, 205, 206, 208. Refer to page 125.</p>	 <p>COTTER PINS NO. 020-033 Contains 340 Cotter Pins. 1/16 x 3/4, 1", 3/32 x 1", 1-1/2; 1/8 x 1", 1-1/2; 5/32 x 2". Refer to page 47.</p>
 <p>MACHINE SCREWS NO. 020-011 Flat Head – Square Drive. Contains 130 Screws, 45 Nuts Sizes same as listed for 020-011</p>	 <p>TAPPING SCREWS NO. 020-023 Oval Head, Phillips. Contains 100 Screws. 6 x 1, 1-1/4 - Oval Regular 8 x 3/4, 1", 1-1/4, 1-3/8, 1-1/2, 1-3/4 10 x 1 - Oval Small. Refer to page 74.</p>	 <p>TOOTH LOCK WASHERS NO. 020-034 Internal Type Plated. Contains 225 Washers. 3/16 x 1/4, 5/16, 3/8, 7/16 and 1/2. Refer to page 57.</p>
 <p>MACHINE SCREWS NO. 020-012 Round Head – Phillips. Contains 100 Screws, 50 Nuts 6-32 x 3/8, 1/2, 3/4; Nuts 8-32 x 3/8, 1/2, 3/4; Nuts 10-32 x 3/8, 1/2, 3/4; Nuts Refer to page 65.</p>	 <p>TAPPING SCREWS NO. 020-024 Hexagon Head. Contains 100 Screws. 8 x 1/2; 10 x 3/8, 1/2, 5/8, 3/4; 14 x 1/2, 5/8, 3/4, 1", 1-1/4; 5/16 x 1". Refer to page 68.</p>	 <p>TOOTH LOCK WASHERS NO. 020-035 External Type Plated. Contains 225 Washers. Size same as listed for 020-034.</p>
 <p>SPEED NUTS NO. 020-015 Flat Type. Contains 160 Nuts. 240-089, 091, 100, 101, 120, 158, 108, 127. Refer to page 84.</p>	 <p>TAPPING SCREWS NO. 020-026 Pan Head Slot. 4 x 1/2; 6 x 1/2, 3/4, 1"; 8 x 1/2, 3/4, 1", 1-1/4; 10 x 5/8, 3/4, 1", 1-1/4; 12 x 3/4, 1"; 14 x 3/4, 1". Refer to page 68.</p>	 <p>INCH & METRIC DRAIN PLUGS NO. 020-038 Hexagon Head. Contains 9 Inch and Metric Drain Plugs. 4 of 1/2-20 STD., 3 of 12mm x 1.75, 2 of 14mm x 1.5. Refer to page 129.</p>
 <p>SPEED NUTS NO. 020-016 Formed Type. Contains 65 Nuts. 240-226, 228, 232, 242, 243, 247, 250, 267. Refer to page 85.</p>	 <p>METRIC TRIM SCREWS NO. 020-027 Pan, Oval — Phillips Trim. Contains 100 Screws. 230-203, 205, 207; 230-302, 304, 305. Refer to page 74.</p>	 <p>SNAP RINGS EXTERNAL NO. 020-040 Contains 60 Snap Rings. 8 Sizes of 268-500 Series. for 1/8" to 1/2" dia. shafts. Refer to page 126.</p>
 <p>SPEED NUTS NO. 020-017 Push-on Type. Contains 160 Nuts 240-320, 325, 331, 335, 355, 365, 370. Refer to page 86.</p>	 <p>HOLE PLUGS NO. 020-028 Contains 47 Plugs. 314-018, 020, 022, 024, 026, 030, 034. Refer to page 136.</p>	 <p>SNAP RINGS EXTERNAL NO. 020-041 Contains 50 External Rings. 6 Sizes of 268-600 Series. for 5/32" to 9/16" dia. shafts. Refer to page 128.</p>
 <p>SPEED NUTS NO. 020-018 Tubular Type. Contains 70 Nuts. 240-430, 431, 432, 469, 471, 472. Refer to page 87.</p>	 <p>FINISHING WASHERS 020-030 Standard and Flush Types. Contains 200 Washers. 162-971, 973, 975, 977, 979, 988, 990, 994. Refer to page 61.</p>	 <p>SNAP RINGS INTERNAL NO. 020-042 Contains 50 Internal Rings. 10 Sizes of 268-200 Series for 1/2" to 2" housing dia. Refer to page 128.</p>
 <p>WOODRUFF KEYS NO. 020-020 Contains 100 Keys. 302-020, 030, 040, 050, 060, 080, 100, 110, 130, 150, 190, 200. Refer to page 134.</p>	 <p>S.A.E. WASHERS 020-031 Small sizes. Contains 400 Washers. No. 2, No. 4, No. 6, No. 8, No. 10, 1/4. Refer to page 54.</p>	 <p>SQUARE HEAD PIPE PLUGS NO. 020-043 Contains 20 Plugs. 260-901, 902 and 903. Refer to page 132.</p>
 <p>WOODRUFF KEYS NO. 020-021 Contains 29 Large Keys. 302-190, 200, 210, 214, 215, 220, 240, 250, 257, 270, 280, 290, 291, 292. Refer to page 134.</p>	 <p>OVERSIZE DRAIN PLUGS NO. 020-032 Contains 7 Plugs with gaskets. 263-711, 712, 713. Refer to page 129.</p>	 <p>STOVE BOLTS NO. 020-044 Round Head, Square Drive. Contains 68 Bolts and Nuts. 3/16 x 1/2, 3/4, 1", 1-1/4, 1-1/2, 2", 1/4 x 1/2, 3/4, 1", 1-1/4, 1-1/2, 2". Refer to page 62.</p>



paperco GARAGE ASSORTMENTS

	STOVE BOLTS NO. 020-045 Flat Head, Square Drive. Contains 68 Bolts and Nuts. Sizes same as listed for 020-044.		UNI-NUT LOCK NUTS NO. 020-066 Contains 45 Nuts. No. 4, No. 6, No. 8, No. 10, No. 14 (1/4), 5/16, 3/8. Refer to page 37.		LIFT-THE-DOT® FASTENERS NO. 020-092 Contains 20 Fasteners. 400-900, 902, 903, 904, 913. Refer to page 147.
	SQUARE HEAD SET SCREWS NO. 020-046 Contains 35 Screws. 1/4 x 1/2, 3/4, 5/16 x 1/2, 3/4 ; 3/8 x 1/2, 3/4, 1" ; 7/16 x 1", 1/2 x 1", 2". Refer to page 39.		WIRING TERMINALS NO. 020-067 Contains 45 Terminals. 569-422, 425, 426, 432, 461, 462, 464, 466, 467, 473, 500, 512, 516, 522, 531. Refer to page 157.		TURN FASTENERS NO. 020-093 Contains 20 Fasteners. 400-901, 905, 910, 911, 912. Refer to page 147.
	LOCK WASHERS NO. 020-047 Contains 235 Washers. 3/16, 1/4, 5/16, 3/8, 7/16, and 1/2. Refer to page 56.		6-LOBE TRIM SCREWS NO. 020-070 Oval Head. Contains 70 Screws. 231-205, 206, 209, 210, 213, 219. Refer to page 77.		HOSE CLAMPS NO. 020-096 Contains 28 Fuel Injection Hose Clamps. 1/4, 5/16, 3/8. Refer to page 139.
	EXPANSION PLUGS NO. 020-048 Contains 50 Plugs. 260-008, 010, 014, 018, 020, 024, 026, 028, 030, 034, 036, 039, 045, 054, 057, 069, 130, 144. Refer to page 121.		6-LOBE TRIM SCREWS NO. 020-071 Pan Head. Contains 70 Screws. 231-251, 252, 257, 264. Refer to page 77.		HOSE CLAMPS NO. 020-097 Contains 60 Constant Tension Hose Clamps. 3/8, 7/16, 1/2, 5/8, 3/4, 1". Refer to page 139.
	TAPER PINS NO. 020-050 Contains 46 Taper Pins. 00 x 1", 1-1/2 ; 0 x 1", 1-1/2 ; 1 x 1", 1-1/2, 2" 2 x 1-1/4, 1-1/2, 2" ; 3 x 1-1/4, 1-1/2, 2" 4 x 2", 2-1/2 ; 5 x 1-1/2, 2", 2-1/2. Refer to page 137.		O-RINGS NO. 020-072 Contains 78 Rings. 15 sizes from 1/8" to 3/4" I.D. Refer to page 135.		METRIC CAP SCREWS NO. 020-125 I.S.O. Coarse Thread. Contains 82 Screws. M4 x 16 ; M5 x 16, 20, 25 ; M6 x 16, 25, 35. Refer to page 26.
	TAPER PINS NO. 020-051 Contains 36 Large size. 4 x 1-1/2, 2", 2-1/2 ; 5 x 1-1/2, 2", 2-1/2 ; 6 x 2", 2-1/2, 3" ; 7 x 3". Refer to page 137.		HITCH PIN CLIPS NO. 020-073 Contains 40 Clips. 255-303, 310, 316, 321, 325, 326. Refer to page 46.		METRIC CAP SCREWS NO. 020-126 I.S.O. Coarse Thread. Contains 25 Screws. M8 x 16, 20, 25, 35 ; M10 x 30, 40, 50. Refer to page 26.
	PALNUTS NO. 020-052 Self-Threading. Contains 100 Nuts. 9 sizes for 1/8" to 5/16" dia. studs in both regular and sealer types. Refer to page 89.		PALNUT LOCK NUTS NO. 020-074 Regular and Washer Types — Inch. Contains 100 Nuts. 242-016, 018, 020, 022. 242-108, 110, 114, 116. Refer to page 89.		METRIC HEX NUTS NO. 020-127 I.S.O. Coarse Thread. Contains 110 Nuts. M4, M5, M6, M8, M10, M12. Refer to page 26.
	TENSILOCK FLANGE NUTS NO. 020-053 Contains 50 Nuts. 118-014, 016, 018, 020 and 022. Refer to page 34.		PALNUT LOCK NUTS NO. 020-075 Regular and Washer Types — Metric. Contains 100 Nuts. 243-004, 005, 105, 106. Refer to page 89.		METRIC LOCK NUTS NO. 020-128 Nylon Collar — Pozzi-Lok. Contains 33 Nuts. M4, M5, M6, M8, M10. Refer to page 26.
	NYLON DRAIN PLUG GASKETS NO. 020-054 Contains 60 Gaskets. 263-816, 817, 818, 820, 824 and 828. Refer to page 129.		BOLT RETAINERS NO. 020-076 Inch sizes. Contains 100 Retainers. 242-314, 316, 318, 320, 322. Refer to page 90.		METRIC FLAT WASHERS NO. 020-129 Contains 235 Washers. 4mm, 5mm, 6mm, 8mm, 10mm. Refer to page 26.
	KEEPS LOCK NUTS NO. 020-055 Contains 75 Nuts. 119-006, 008, 010, 011, 014, 015, 016 and 018. Refer to page 37.		BOLT RETAINERS NO. 020-077 Metric Sizes. Contains 100 Retainers. 243-306, 308, 310, 312. Refer to page 90.		METRIC LOCK WASHERS NO. 020-130 Contains 300 Washers. 4mm, 5mm, 6mm, 8mm, 10mm. Refer to page 26.
	BRASS WASHERS NO. 020-056 Contains 100 Washers. 162-810, 812, 814, 816, 818, 820 and 822. Refer to page 60.		'U' NUTS NO. 020-078 Multi-Thread. Contains 65 Nuts. 240-614, 616, 617, 618. Refer to page 91.		METRIC SPRING WASHERS NO. 020-131 Contains 250 Washers. 4mm, 5mm, 6mm, 8mm, 10mm. Refer to page 26.
	FENDER WASHERS NO. 020-057 Contains 71 Washers. 1/4 x 1-1/4 ; 5/16 x 1", 1-1/4 ; 3/8 x 1-1/2. Refer to page 58.		'U' NUTS NO. 020-079 Multi-Thread — Metric. Contains 50 Nuts. 241-604, 605, 606, 607, 608, 609, 610. Refer to page 91.		METRIC SOCKET SET SCREWS NO. 020-132 Contains 29 Screws. M4 x 5, 10 ; M5 x 10, 15 ; M6 x 8, 12, 20 ; M8 x 8, 12, 20. Refer to page 26.
	STEEL SPACER WASHERS NO. 020-058 Contains 125 Washers. 1/4, 5/16, 3/8, 7/16, 1/2, 9/16, 5/8, 3/4, 7/8, 1", 1-1/8, 1-1/4, 1-3/8 and 1-1/2. Refer to page 61.		'U' NUTS NO. 020-080 Single-Thread. Contains 65 Nuts. 240-708, 709, 710, 714, 715. Refer to page 91.		METRIC MACHINE SCREWS NO. 020-133 Contains 210 Screws and Nuts. M4 x 6, 12 — Nuts M5 x 10, 16 — Nuts M6 x 10, 16, 20 — Nuts Refer to page 26.
	FIBRE WASHERS NO. 020-059 Contains 130 Washers. 1/32" Thick — 162-203, 206, 209, 211, 212, 214, 215, 210, 221. 1/16" Thick — 162-256, 259, 261, 262. Refer to page 58.		BLIND WELL NUTS NO. 020-081 Contains 20 Nuts. 6-32, 8-32, 10-32, 1/4-20. Refer to page 83.		METRIC COTTER PINS NO. 020-134 Contains 275 Pins. 1.5 x 16 ; 2 x 20 ; 3 x 25, 40 ; 4 x 50. Refer to page 26.
	UNIVERSAL CLEVIS PINS NO. 020-061 Contains 15 Pins. 255-044, 054, 064. Refer to page 45.		COPPER WASHERS NO. 020-083 Contains 100 Washers. 162-860, 864, 866, 868, 870, 872. Refer to page 60.		METRIC SPRING PINS NO. 020-135 Contains 64 Pins. 2 x 16 ; 2.5 x 18 ; 3 x 40 ; 4 x 18, 36 ; 5 x 36, 50 ; 6 x 50. Refer to page 26.
	CLEVIS PINS NO. 020-062 Contains 41 Pins. 255-225, 226, 228, 230, 231, 235, 236, 237, 238, 241, 242, 244, 246, 251. Refer to page 46.		PUSHNUT FASTENERS NO. 020-084 Contains 100 Fasteners. 242-406, 408, 410, 414, 416, 418, 422 ; 243-404, 405. Refer to page 90.		TAPPING SCREWS NO. 020-200 Pan Head — Socket Steel. Contains 175 Screws. 6 x 1/2 ; 6 x 5/8 ; 8 x 5/8 ; 8 x 3/4 ; 8 x 1 ; 10 x 1/2 ; 10 x 3/4 ; 10 x 1. Refer to page 68.
	UTILITY SPRINGS NO. 020-063 Compression and Extension Types. Contains 100 Springs Refer to page 144.		SOCKET PIPE PLUGS NO. 020-087 Contains 20 Pipe Plugs. 260-921, 922 and 923. Refer to page 132.		WOOD SCREWS NO. 020-201 Flat Head — Socket Steel. Contains 160 Screws. 6 x 1/2 ; 6 x 5/8 ; 6 x 3/4 ; 8 x 3/4 ; 8 x 1 ; 8 x 1-1/4 ; 10 x 1 ; 10 x 1-1/4. Refer to page 66.
	POZI-LOCK NUTS NO. 020-064 UNC Coarse Thread. Contains 40 Nuts. 1/4, 5/16, 3/8, 7/16 and 1/2 Refer to page 35.		CABLE CLAMPS NO. 020-088 Contains 40 Nylon Clamps. 1/4, 3/8, 1/2, 5/8, 3/4, 1". Refer to page 146.		BRASS WOOD SCREWS NO. 020-210 Contains 155 pieces — 8 sizes. 6 x 1/2, 3/4, 1" ; 8 x 3/4, 1" ; 1-1/4, 1-1/2 Flat Socket Head — 6 x 3/4 Round Socket Head. Refer to page 66.
	POZI-LOCK NUTS NO. 020-065 UNF Fine Thread. Contains 40 Nuts. 1/4, 5/16, 3/8, 7/16 and 1/2 Refer to page 35.		SERT-A-NUTS NO. 020-090 Contains 20 Inserts plus Installation Tools. 6-32, 8-32, 10-24, and 1/4-20. Refer to page 83.		STAINLESS STEEL FASTENERS NO. 020-212 Contains 110 pieces — 8 sizes. 6 x 3/4 ; 8 x 3/4, 1" ; 10 x 1, 1-1/2 Pan Socket. 6 x 3/4, 1" ; 8 x 1" Oval Socket Tapping Screws. No. 6, 8 Finishing Washers. Refer to page 164.
			SNAP FASTENERS NO. 020-091 Contains 25 Fasteners. 400-980, 981, 982, 983, 984, 985, 997. Refer to page 147.		

Note: Contents of assortments subject to change with market



FOR GARAGE AND HARDWARE USE

These practical assortments enable every garage and repair shop to carry a useful stock of these popular fastener.

- Every size in an individual compartment.
- Sturdy, reinforced fireboard display boxes with plastic trays.
- Wide range of popular items at small cost.
- Refills available from standard stock.
- Suggested retail codes shown in lid.
- Contents bright plated.
- 5-1/2" w. x 11-1/4" l. x 1-1/2" d.

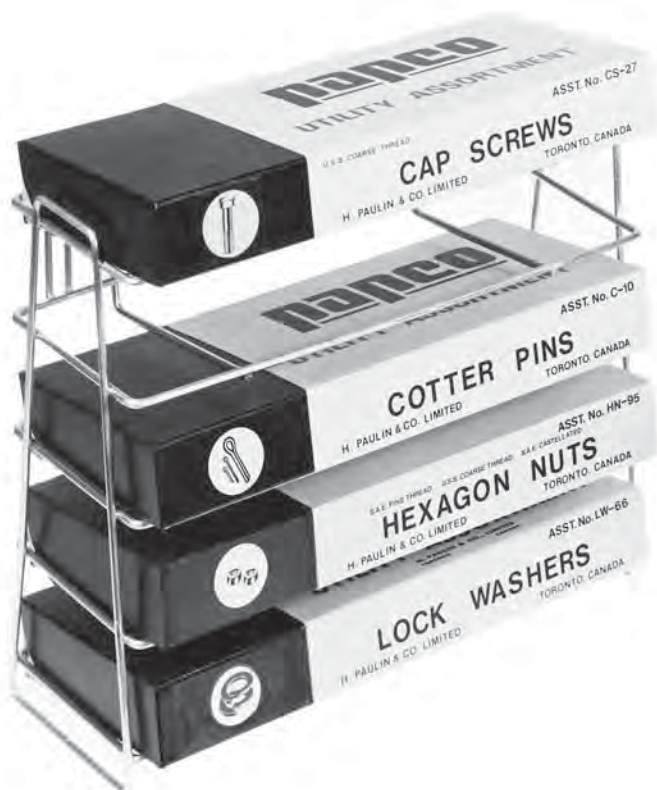



paperco UTILITY ASSORTMENTS

	WING NUTS NO. 020-310 Forged Steel. Contains 151 Wing Nuts. 8-31, 10-24, 1/4-20, 5/16-18, 3/8-16. Refer to page 36.		CAP SCREWS NO. 020-327 U.N.C. Coarse Thread. Contains 105 Screws. Sizes same as listed for 020-326.		SQUARE HEAD SET SCREW NO. 020-344 Contains 66 Screws. 1/4 x 1/2, 1", 5/16 x 3/4, 1", 1-1/2 ; 3/8 x 3/4, 1", 1-1/2 ; 1/2 x 1", 2". Refer to page 39.
	WHEEL NUTS NO. 020-311 Contains 40 Wheel Nuts. 558-014, 016, 027, 044, 047, 100 ; 559-125, 150. Refer to separate catalogue Refer to page 154.		SOCKET HEAD CAP SCREWS NO. 020-328 Contains 36 Screws. 1/4 x 3/4, 1", 1-1/2 ; 5/16 x 3/4, 1", 1-1/2 ; 3/8 x 1", 1-1/2 ; 7/16 x 1-1/2 ; 1/2 x 1-1/2. Refer to page 40.		HEX NUTS NO. 020-347 U.N.C. and U.N.F. Contains 133 Nuts. 1/4, 5/16, 3/8, 7/16, and 1/2. Refer to page 29.
	TAPPING SCREWS NO. 020-312 Pan and Oval Slot. Contains 495 Screws. Pan — 6 x 3/8, 1/2, 3/4, 1" ; 8 x 3/8, 1/2, 3/4, 1" ; 10 x 1/2, 3/4, 1" ; 14 x 1". Oval — 6 x 3/4, 1" ; 8 x 3/4, 1" ; 10 x 3/4, 1". Refer to page 68.		CLEVIS PINS NO. 020-329 Universal Type. Contains 24 Pins with Cotter Pins. 255-044, 054, 064, 074, 084, 106. Refer to page 45.		STOVER® LOCKNUTS NO. 020-348 U.N.F. Fine Thread Contains 90 Nuts. 1/4, 5/16, 3/8, 7/16, and 1/2. Refer to page 34.
	COTTER PINS NO. 020-313 Contains 1000 Cotter Pins. 1/16 x 3/4, 1", 1-1/2 ; 3/32 x 3/4, 1", 1-1/2 ; 1/8 x 1", 1-1/2, 2" ; 5/32 x 1-1/2. Refer to page 47.		CARRIAGE BOLTS NO. 020-330 Contains 70 Bolts and 70 Nuts. 1/4 x 1", 1-1/2 ; 5/16 x 1", 1-1/2, 2" ; 3/8 x 1", 1-1/2, 2", 3" ; 1/2 x 2", 3", 3-1/2 ; 5/8 x 3", 4". Refer to page 38.		STOVER® LOCKNUTS NO. 020-349 U.N.C. Coarse Thread Contains 90 Nuts. 1/4, 5/16, 3/8, 7/16, and 1/2. Refer to page 34.
	HAMMER-LOCK COTTER PINS NO. 020-314 Contains 800 Pins. 1/16 x 3/4, 1", 1-1/2 ; 3/32 x 3/4, 1", 1-1/2 ; 1/8 x 1", 1-1/2, 2" ; 5/32 x 1-1/2. Refer to page 48.		MACHINE SCREWS NO. 021-331 Round Head — Square Drive. Contains 320 Screws and 320 Nuts. 4-40 x 1/2, 3/4 — Nuts. 6-32 x 3/8, 1/2, 3/4, 1" — Nuts. 8-32 x 3/8, 1/2, 3/4, 1", 1-1/2, 2" — Nuts. 10-32 x 1/2, 3/4, 1", 1-1/2 — Nuts. Refer to page 64.		TENSION WASHERS NO. 020-351 Contains 210 Washers. 3/16, 1/4, 5/16, 3/8, 7/16, and 1/2. Refer to page 61.
	SPEED NUTS NO. 020-315 Flat Type. Contains 325 Nuts. 240-090, 091, 097, 100, 101, 107, 120, 121, 127, 160. Refer to page 87.		SQUARE HEAD PIPE PLUGS NO. 020-332 Contains 42 Plugs. 1/8, 1/4, 3/8, 1/2. Refer to page 132.		PLAIN STEEL WASHERS NO. 020-352 Contains 379 Washers (5.5 lbs.). 3/16, 1/4, 5/16, 3/8, 7/16, 1/2, 9/16, and 5/8 — Bolt Sizes. Refer to page 53.
	SPEED NUTS NO. 020-316 Formed Type. Contains 110 Nuts. 240-210, 220, 227, 243, 246, 247, 248, 249, 263, 268. Refer to page 87.		MACHINE SCREWS NO. 020-333 Flat Head — Square Drive. Contains 350 Bolts and 350 Nuts. Refer to page 64.		TAPPING SCREWS NO. 020-353 Pan Head — Socket. Contains 500 Screws. 4 x 1/2 ; 6 x 3/8, 1/2, 3/4, 1" ; 8 x 3/8, 1/2, 3/4, 1", 1-1/4 ; 10 x 1/2, 5/8, 3/4, 1" ; 12 x 3/4 ; 14 x 1". Refer to page 68.
	SPEED NUTS NO. 020-317 Push-on and Tubular. Contains 275 Nuts. 240-320, 325, 340, 350, 355, 365, 370, 375, 410, 415, 430, 431, 440. Refer to page 87.		SOCKET KEYS NO. 020-335 Contains 52 Keys. 140-102, 103, 104, 107, 108, 109, 110, 111, 112. Refer to page 41.		WOOD SCREWS NO. 020-354 Flat and Round Head — Socket. Contains 460 Screws. Flat — 4 x 1/2 ; 5 x 5/8 ; 6 x 3/4 ; 8 x 3/4, 1", 1-1/4, 1-1/2 ; 10 x 1/2. Round — 4 x 1/2 ; 5 x 5/8 ; 6 x 3/4 ; 8 x 1". Refer to page 66.
	'E-Z SEAL' EXPANSION PLUGS NO. 020-318 Contains 13 Plugs. 263-548, 556, 564, 572, 580, 588, 596, 604, 612, 620, 628, 633, 644. Refer to page 122.		ACORN (CAP) NUTS NO. 020-336 Zinc Alloy — Nickel Plated. Contains 87 Nuts. 6-32, 8-32, 10-24, 1/4-20, 5/16-18, 3/8-16, 1/2-13. Refer to page 36.		6-LOBE TRIM SCREWS NO. 020-355 Oval and Pan Head. Contains 140 Screws. 231-205, 206, 209, 210, 213, 219, 251, 252, 257, 264. Refer to page 77.
	SPRING PINS NO. 020-319 Contains 116 Pins. 3/32 x 1/2, 1" ; 1/8 x 1/2, 1" ; 5/32 x 3/4, 1-1/2 ; 3/16 x 1", 1-1/2 ; 1/4 x 1", 1-1/2 ; 5/16 x 1-1/2 ; 3/8 x 2". Refer to page 133.		HITCH PIN CLIPS NO. 020-338 Contains 105 Clips. 255-303, 306, 307, 308, 310, 311, 316, 320. Refer to page 46.		BRASS WOOD SCREWS NO. 020-356 Flat and Round Head — Socket. Contains 380 Screws. 4 x 1/2 ; 5 x 5/8 ; 6 x 3/4 ; 8 x 3/4, 1", 1-1/4, 1-1/2 ; 10 x 1/2 — Flat Socket. 4 x 1/2 ; 5 x 5/8 ; 6 x 3/4 ; 8 x 1" — Round Socket. Refer to page 66.
	SOCKET SET SCREWS NO. 020-321 Contains 120 Screws. Refer to page 42.		LOCK WASHERS NO. 020-339 Contains 505 Washers. 3/16, 1/4, 5/16, 3/8, 7/16, 1/2, 9/16, 5/8, 3/4. Refer to page 56.		'PLASTI-RIVETS' NO. 020-357 Contains 130 Rivets. 247-410, 415, 420, 450, 455, 460, 465, 470, 475, 480, 485. Refer to pages 103, 104.
	BRASS COTTER PINS NO. 020-322 Contains 500 Pins. 3/64 x 3/8 ; 1/16 x 3/4, 1", 1-1/2 ; 3/32 x 3/4, 1", 1-1/2 ; 1/8 x 1", 1-1/2, 2". Refer to page 48.		TOOTH LOCK WASHERS NO. 020-340 Internal and External Types. Contains 900 Washers. No. 6, No. 8, No. 10, 1/4, 5/16, 3/8, 7/16, 1/2. Refer to page 57.		ANCHOR NUTS NO. 020-358 Contains 150 Anchor Nuts. Complete coverage. Refer to page 103.
	STOVE BOLTS NO. 020-323 Round Head — Longer Lengths. Contains 80 Bolts and 80 Nuts. 3/16 x 1/2, 3/4, 1", 1-1/2 ; 1/4 x 3/4, 1", 1-1/2, 2". Refer to page 62.		S.A.E. WASHERS NO. 020-341 Contains 370 Washers. 3/16, 1/4, 5/16, 3/8, 7/16, 1/2, 9/16, and 5/8. Refer to page 54.		METRIC CAP SCREWS NO. 020-425 Fine Thread Series. Contains 100 Screws and Nuts. Refer to page 26.
	STOVE BOLTS NO. 020-324 Round Head — Square Drive. Contains 200 Bolts and 200 Nuts. 3/16 x 1/2, 3/4, 1", 1-1/2 ; 1/4 x 3/4, 1", 1-1/2, 2". Refer to page 62.		UTILITY SPRINGS NO. 020-342 Extension and Compression. Contains 83 Springs. 311-604, 605, 606, 608, 609, 610, 611, 612, 615, 616, 618, 676, 677, 678, 684. Refer to page 144.		METRIC CAP SCREWS NO. 020-426 I.S.O. Coarse Thread. Contains 160 Screws and Nuts. Refer to page 26.
	CAP SCREWS NO. 020-326 U.N.F. Fine Thread. Contains 105 Screws. 1/4 x 3/4, 1", 1-1/2 ; 5/16 x 3/4, 1", 1-1/2 ; 3/8 x 1", 1-1/2 ; 7/16 x 1-1/2 ; 1/2 x 1-1/2. Refer to page 29.		COTTER PINS NO. 020-343 Large sizes. Contains 195 Pins. 5/32 x 2" ; 3/16 x 2", 2-1/2 ; 1/4 x 2", 2-1/2, 3" ; 5/16 x 2-1/2, 3" ; 3/8 x 3". Refer to page 47.		

Note: Contents of assortments subject to change with market

Papco STAX-SIX CABINET



The modern method of stocking Master Assortments. Each steel STAX-SIX Cabinet holds six Master Assortments in its own rigid drawer slide.

No. 022-091



(Assortments or Assortment Drawers NOT included.)

- Heavy gauge steel construction.
- Baked black enamel finish.
- Rigid drawer slide.
- No spill feature.

No. 022-090
 Holds one Master Assortment

- Build as you buy.
- Designed for efficient stacking one on top of another.

NOT ILLUSTRATED

MASTER ASSORTMENTS

<p>COMPRESSION FITTINGS * NO. 020-500 Contains 99 Fittings. 660-3, 660-4, 660-5, 660-6, 661-3, 661-4, 661-5, 661-6, 662-3, 662-4, 662-5, 662-6, 668-2A, 668-3A, 668-4A, 668-5A, 669-2A, 669-3A, 669-4A, 669-5A.</p> <p>FLARE FITTINGS * NO. 020-501 Contains 45 Fittings. 441-3, 441-4, 441-5, 441-6, 442-3, 442-4, 442-5, 442-6, 446-4A, 446-5A, 448-3A, 448-4A, 448-4B, 448-5A, 448-5B, 448-6B, 449-4A, 449-5B, 449-6B.</p> <p>INVERTED FLARE * NO. 020-502 Contains 84 Fittings. 141-3, 141-4, 141-5, 141-6, LS141-3, LS141-4, 142-3, 142-4, 142-5, 142-6, 148-3A, 148-4A, 148-5A, 148-5B, 148-6B, 149-3A, 149-4A, 149-5A, 149-5B, 149-6B.</p> <p>PIPE FITTINGS * NO. 020-503 Contains 71 Fittings. 101-A, 101-B, 103-A, 103-B, 109-A, 109-B, 109-C, 110-BA, 110-CB, 110-DC, 112-A, 112-B, 112-C, 115-A, 115-B, 115-C, 124-A, 124-B, 124-C, TF-8.</p> <p>FUEL LINE FITTINGS * NO. 020-505 Contains 70 Fittings. P1537, P1551, P1555, P1556, P1557, P1560, P1561, P1564, P1565, P1566, P1570, P1571, P1572, P1581, P1582, P1598, 101-C, 307-001, 307-002, 307-008.</p> <p>HOSE BARBS * NO. 020-506 Contains 59 Fittings. 9125-4A, 9125-4B, 9125-5A, 9125-5B, 9125-6B, 9125-6C, 9125-8C, 9125-8D, 9125-10C, 9125-10D, 9125-12D, 9125-12E, 9126-4A, 9126-4B, 9126-6B, 9126-6C, 9126-8D, 9129-4, 9129-6, 9129-8.</p> <p>HYDRAULIC BRAKE FITTINGS * NO. 020-507 Contains 52 Fittings. S141-3, S141-4, S141-5, 142-3, 142-4, 142-5, PC1176, PC1177, PC1190, PC1191, PC1192, 7818, 7828, 7829, 7897, 7908, 7910, 7911, 7912.</p> <p>WOOD SCREWS NO. 020-600 Flat and Round Head — Socket. Contains 850 Screws. 4 x 1/2, 3/4, 5 x 5/8; 6 x 3/4, 1", 1-1/4, 1-1/2; 8 x 3/4, 1", 1-1/4, 1-1/2; 10 x 3/4, 1", 1-1/2 — Flat Socket. 4 x 1/2; 5 x 5/8; 6 x 3/4; 8 x 3/4, 1", 1-1/4; 10 x 1-1/2 — Round Socket. Refer to page 66.</p> <p>BRASS WOOD SCREWS NO. 020-601 Flat and Round Head — Socket. Contains 735 Screws. Sizes same as listed for 020-600</p>	<p>BRAKE BLEEDER SCREWS NO. 020-604 Contains 63 pcs. 904-200, 201, 203, 204, 206, 209, 212, 213, 218, 219, DS141-3, -4, -5, -6, PC1176, PC1177, PC1178, MA300, MC300. Refer to page 170.</p> <p>VACUUM CONNECTORS NO. 020-605 Contains 138 pcs. 904-901, 902, 920, 922, 923, 924, 932, 939, 941, 960, 965, 975, 976, 990, 991, 992, 339. Refer to page 167.</p> <p>DRAIN COCKS AND FITTINGS NO. 020-606 Contains 119 Fittings. D39B, D40B, D60-3, -4, -5, -6, D61-3, -4, -5, -6, D62-3, -4, -5, -6; 260-902, 903, 904, 951, 952, 953, 957, 958. Refer to page 117.</p> <p>DRAIN PLUG GASKETS NO. 020-607 Contains 210 Gaskets. 263-800, 801, 802, 803, 804, 805, 807, 808, 809, 810, 815, 816, 817, 818, 855, 856, 860, 870, 873, 875. Refer to pages 129, 131.</p> <p>WING NUTS AND HOOD PROPS NO. 020-608 103-010,014, 016, 018; 247-808, 809, 813, 823, 861; 263-314, 316, 324, 325, 326; 700-106, 108. Refer to page 124.</p> <p>CARBURETOR CLIPS NO. 020-609 Contains 293 Clips. 262-008, 009, 010, 011, 014, 015, 054, 056, 062, 064, 073, 075, 076, 078, 080, 084, 088, 268-516. Refer to page 125.</p> <p>TAPER PINS NO. 020-610 Contains 100 Pins. 00 x 1", 1-1/2; 0 x 1", 1-1/2; 1 x 1", 1-1/2, 2" 2 x 1-1/4, 1-1/2, 2"; 3 x 1-1/4, 1-1/2, 2" 4 x 1-1/2, 2", 2-1/2; 5 x 1-1/2, 2", 2-1/2, 3". Refer to page 137.</p> <p>BUMPER BAR BOLTS NO. 020-611 Contains 68 Bolts and 68 Nuts. 245-154, 160, 161, 164, 165, 167, 172, 173, 174, 175, 182, 183, 184, 220, 221; 101-916, 918, 920, 922; 700-008. Refer to page 94.</p> <p>TAPPING SCREWS NO. 020-612 Pan, Oval and Hex — Slot. Contains 937 Screws. Pan — 6 x 3/8, 1/2, 3/4, 1"; 8 x 3/8, 1/2, 3/4, 1"; 10 x 1/2, 3/4, 1"; 14 x 1". Oval — 6 x 3/4, 1"; 10 x 3/4. Hex — 8 x 1/2; 10 x 3/4; 14 x 1". Refer to pages 67, 68, 69.</p>	<p>TAPPING SCREWS NO. 020-613 Pan, Oval Regular, Oval Small — Phillips. Contains 530 Screws. Pan — 6 x 1/2; 8 x 1/2, 3/4; 10 x 1/2, 3/4. Oval Reg. — 6 x 3/4, 1"; 8 x 3/4, 1"; 10 x 5/8, 1". Oval Small — 8 x 1/2, 3/4, 1", 1-1/8, 1-1/4, 1-1/2; 10 x 3/4, 1", 1-1/2. 230-205, 207, 302, 304, 305. Refer to page 74.</p> <p>WOODRUFF KEYS NO. 020-614 Contains 210 Keys. 302-010, 020, 030, 040, 050, 060, 070, 080, 090, 100, 110, 121, 130, 150, 152, 160, 180, 200, 210, 240. Refer to page 134.</p> <p>TAPPING SCREWS NO. 020-615 Hexagon Head — Fender Washers. Contains 280 Screws — 125 Washers. 8 x 1/2; 10 x 3/8, 1/2, 5/8, 3/4; 14 x 1/2, 5/8, 3/4, 1", 1-1/4; 5/16 x 3/4, 1", 1-1/2; 3/8 x 1", 1-1/2; 162-394, 395, 396, 397, 398. Refer to pages 68, 69.</p> <p>MARINE FASTENERS NO. 020-616 Solid Brass — Nickel Plated. Contains 1005 pieces. Wood Screws — Oval Slot. 6 x 3/4; 8 x 3/4, 1", 1-1/4, 1-1/2; 10 x 1-1/4. Machine Screws — Oval Slot. 6-32 x 1"; 8-32 x 1", 1-1/2; 10-24 x 1-1/2; 1/4-20 x 2". Hex Machine Screw Nuts. 6-32, 8-32, 10-24, 1/4-20. Finishing Washers — Countersunk. No. 6, 8, 10. Refer to page 163.</p> <p>SPEE-DRILL SCREWS 020-617 Contains 1000 Screws. 6 x 3/8; 7 x 1/2; 8 x 1/2; 10 x 1/2, 3/4. Also includes Magnetic Chuck. Refer to page 73.</p> <p>COTTER PINS NO. 020-618 Contains 1230 Pins. 1/16 x 1/2, 3/4, 1", 1-1/4, 1-1/2; 3/32 x 3/4, 1", 1-1/4; 1/8 x 1-1/2, 1-3/4, 2"; 5/32 x 1-1/2, 2"; 3/16 x 1-1/2, 2". Refer to page 47.</p> <p>S.A.E. WASHERS NO. 020-619 Contains 1200 Washers. 1/8, 3/16, 1/4, 5/16, 3/8, 7/16, 1/2, 9/16, 5/8, 3/4, 7/8, 1". Refer to page 54.</p> <p>PLAIN STEEL WASHERS NO. 020-620 Contains 1615 Washers. 1/8, 3/16, 1/4, 5/16, 3/8, 7/16, 1/2, 9/16, 5/8, 3/4. Refer to page 53.</p>
--	---	--

* For these Assortments see current 'Papco' Brass Fittings catalogue.



paperco MASTER ASSORTMENTS

LOCK WASHERS NO. 020-621
Contains 1257 Washers.
1/8, 5/32, 3/16, 1/4, 5/16, 3/8, 7/16, 1/2, 9/16, 5/8, 3/4, 7/8, 1".
Refer to pages 55, 56.

BOLTS, NUTS, SCREWS NO. 020-622
Cap Screws (U.N.C.), Nuts (U.N.C.), Lock Washers, S.A.E. Washers, Stove Bolts (Round Head).
Contains 155 Screws, 143 Nuts, 924 Washers, 145 Bolts.
Cap Screws — 1/4 x 3/4, 1"; 5/16 x 3/4, 1"; 3/8 x 1", 1-1/2.
Nuts — 1/4, 5/16, 3/8.
Lock Washers — 1/4, 5/16, 3/8.
S.A.E. Washers — 1/4, 5/16, 3/8.
Stove Bolts — 3/16 x 1"; 1/4 x 3/4, 1".
Refer to pages 29, 30.

MACHINE SCREWS NO. 020-623
Round and Oval Head — Phillips.
Contains 393 Screws, 393 Nuts.
Round — 6-32 x 3/8, 1/2; 8-32 x 3/8, 1/2, 3/4, 1"; 10-32 x 1/2, 3/4; 10-24 x 1/2; 1/4-20 x 1/2, 3/4, 1".
Oval — 8-32 x 1/2; 10-32 x 1/2; 10-24 x 3/4.
Nuts — 6-32, 8-32, 10-32, 10-24, 1/4-20.
Refer to page 65.

MACHINE SCREWS NO. 020-624
Round and Flat Head Square Drive.
Contains 560 Screws, 560 Nuts.
Round — 6-32 x 3/8, 1/2, 1", 1-1/2; 8-32 x 3/4, 1", 1-1/2; 10-32 x 1/2, 1", 1-1/2; 1/4-20 x 3/4, 1", 1-1/4.
Flat — 6-32 x 3/8, 1/2, 1"; 8-32 x 1/2, 3/4, 1", 1-1/2; 10-32 x 1/2, 1", 1-1/2; 1/4-20 x 1".
Nuts — 6-32, 8-32, 10-32, 10-24, 1/4-20.
Refer to pages 63, 64.

TOOTH LOCK WASHERS NO. 020-625
Internal and External Types Plated.
Contains 1370 Washers.
161-106, 108, 110, 114, 118, 120, 122, 124, 128, 132, 206, 208, 210, 214, 218, 220, 222, 224, 228, 232.
Refer to page 57.

UNIVERSAL O-RINGS NO. 020-626
Contains 300 Rings.
Complete coverage.
Refer to page 135.

SNAP RINGS NO. 020-627
Contains 401 Rings — 36 sizes.
268-222, 224, 226, 227, 230, 231, 232, 234, 237, 238, 242, 246, 329, 330, 332, 414, 418, 422, 424, 426, 428, 430, 505, 506, 511, 514, 516, 518, 520, 522, 606, 610, 614, 616, 618, 620.
Refer to page 126.

BATTERY HOLD-DOWN BOLTS NO. 020-628
Contains 130 pieces.
570-610, 611, 612, 613, 614, 615, 617.
Refer to page 162.

SOCKET SET SCREWS NO. 020-629
Contains 166 Screws.
138-132, 133, 184, 185, 301, 303, 305, 437, 438, 440, 483, 575; 139-184, 301, 437.
Refer to pages 40, 42.

PERMA-THREAD INSERTS NO. 020-631
Includes contents of one Repair Kit of each 10-24, 1/4-20, 5/16-18, 3/8-16, 7/16-14, 1/2-13 and 14mm with 3/8, 7/16, 1/2 and 3/4 reach.
Includes Inserts, Taps, Installation Tools, and Instructions.
Refer to page 165.

MANIFOLD STUDS AND NUTS NO. 020-632
Contains 80 pieces.
Studs — 264-048, 049, 060, 094.
Nuts — 264-954, 955, 956, 957, 958, 959.
Refer to pages 114, 115.

EXPANSION PLUGS NO. 020-633
Contains 110 Cup and Shallow Cup Types.
260-114, 120, 130, 142, 144, 159, 168, 174, 186, 194, 198, 219, 311, 327, 333, 339, 365, 368.
Refer to page 121.

DRAIN PLUGS NO. 020-635
Contains 40 Plugs and 85 Gaskets.
260-902, 903, 904.
263-710, 711, 712, 713, 781, 784, 794, 815, 816, 817, 820, 824, 828, 855, 856, 857, 860, 911, 913, 914, 916, 918, 920.
Refer to pages 129, 130.

SQUARE HEAD SET SCREWS NO. 020-636
Contains 82 Screws.
1/4 x 1/2, 3/4, 1"; 5/16 x 1/2, 3/4, 1", 1-1/2; 3/8 x 1/2, 3/4, 1", 1-1/4, 1-1/2; 7/16 x 3/4, 1", 1-1/2; 1/2 x 3/4, 1", 1-1/4, 1-1/2, 2".
Refer to page 39.

UTILITY SPRINGS NO. 020-637
Contains 250 Compression, Extension and Throttle Springs.
311-601, 602, 603, 604, 605, 606, 607, 608, 610, 611, 612, 615, 616, 617, 618, 622, 623, 624, 628, 631, 632, 635, 636, 650, 653, 655, 656, 658, 661, 676, 677, 678.
Refer to pages 143, 144.

EXHAUST SYSTEM FASTENERS NO. 020-639
Contains 170 pieces.
Cap Screws — 5/16-18 x 1-1/4, 1-1/2, 2"; 3/8-16 x 1-1/2, 2", 4-1/2, 5-1/2; 7/16-14 x 2"; 9/16-12 x 2".
Brass Nuts — 264-955, 958, 959, 957.
Steel Nuts — 264-903, 905, 908.
Carriage Bolts — 5/16 x 1-1/2; 3/8 x 1-1/2.
Hex Nuts — 5/16-18, 3/8-16, 7/16-14, 9/16-12.
Refer to pages 114, 115.

EXPANSION PLUGS NO. 020-640
Contains 140 Standard and Cup Types.
260-008, 010, 014, 018, 020, 024, 028, 030, 036, 039, 045, 054, 057, 069, 114, 159, 174, 186, 194.
Refer to page 121.

CLEVIS PINS NO. 020-641
Contains 78 Pins.
255-044, 054, 064, 074, 086, 203, 221, 224, 225, 226, 228, 235, 236, 237, 241, 244, 245, 246, 251, 248.
Refer to pages 46.

SPRING PINS NO. 020-642
Contains 275 Pins.
3/32 x 1/2, 3/4, 1"; 1/8 x 1/2, 3/4, 1"; 5/32 x 3/4, 1", 1-1/2; 3/16 x 3/4, 1", 1-1/2; 1/4 x 1-1/2, 2"; 5/16 x 1", 1-1/2, 2"; 3/8 x 1-1/2, 2".
Refer to pages 133.

SPEED NUTS NO. 020-643
Contains 467 Push-on and Tubular Types.
240-310, 315, 320, 325, 330, 331, 335, 340, 350, 355, 360, 365, 370, 375, 380, 405, 410, 430, 431, 450, 470, 471.
Refer to page 88.

SPEED NUTS NO. 020-644
Contains 421 Formed and Flat Types.
240-090, 091, 097, 100, 101, 107, 120, 121, 125, 127, 160, 210, 220, 227, 248, 249, 260, 263, 267, 268.
Refer to page 88.

CASTER AND CAMBER SHIMS NO. 020-645
Contains 310 Shims.
250-081, 082, 083, 091, 092, 093, 095, 096, 097, 098, 105, 106, 107, 108, 166, 168, 170, 176, 177, 178, 179, 192, 193, 194, 195, 282, 283, 284.
Refer to page 111.

CAP SCREWS NO. 020-646
Contains 208 U.N.F. Fine Thread.
Grade 5 Plated.
1/4 x 1/2, 3/4, 1", 1-1/2, 2"; 5/16 x 3/4, 1", 1-1/4; 5/16 x 1-1/2, 2"; 3/8 x 1", 1-1/2, 2"; 7/16, 1", 1-1/2, 2"; 1/2 x 1-1/2, 2"; 5/8 x 1-1/2, 2".
Refer to page 28, 29.

CAP SCREWS NO. 020-647
Contains 208 U.N.C. Coarse Thread.
Grade 5 Plated.
Same sizes as listed for 020-646.

HEX NUTS NO. 020-648
Contains 376 Nuts.
U.N.C., U.N.F. and Thick Slotted.
1/4, 5/16, 3/8, 7/16, 1/2, 5/8, 3/4.
Refer to pages 29, 31.

POZI-LOK NUTS NO. 020-649
Contains 175 of both U.N.C. Coarse and U.N.F. Fine Threads.
1/4, 5/16, 3/8, 7/16, 1/2, 9/16, 5/8, 3/4.
Refer to page 35.

WIRING TERMINALS NO. 020-650
Contains 325 Wiring Terminals.
Complete coverage.
Refer to page 157.

WHEEL PARTS NO. 020-658
Contains 125 Bolts and Nuts.
558-014, 016, 027; 559-150; 560-103, 114, 138, 148, 155, 167, 172, 173, 386; 561-108, 109, 110, 129, 212, 248, 251.
Refer to page 154.

TAPPING SCREWS NO. 020-660
Pan Head-Socket.
Contains 1000 Screws.
4 x 3/8, 1/2; 6 x 3/8, 1/2, 3/4, 1"; 8 x 3/8, 1/2, 5/8, 3/4, 1", 1-1/4, 1-1/2; 10 x 1/2, 3/4, 1", 1-1/4, 1-1/2, 2"; 12 x 3/4, 1", 1-1/4; 14 x 1", 1-1/2, 2".
Refer to pages 68, 69.

CHROME TRIM SCREWS NO. 020-661
Contains 350 Screws.
229-806, 811, 815, 819, 833, 837, 985, 986, 230-203, 205, 206, 207, 301, 302, 304, 305.
Refer to page 73.

BLACK TRIM SCREWS NO. 020-662
Contains 350 Screws.
229-401, 402, 403, 405, 407, 414, 416, 849, 851, 855, 883, 887, 911, 915, 919, 933, 937, 945, 962, 968, 972, 980, 982, 987, 988; 230-303, 306.
Refer to page 73.

METRIC EXPANSION PLUGS NO. 020-666
Contains 120 Standard and Cup Types.
261-024, 046, 090, 100, 107, 126, 132, 145, 155, 161, 165, 177, 182, 184, 185, 188.
Refer to page 121.

BLIND RIVETS NO. 020-667
Contains 1200 pieces.
239-492, 493, 494, 611, 617, 653, 714, 717, 750, 753, 811, 814, 817.
Refer to pages 80, 81.

'DRILL-X' SELF-TAPPING SCREWS NO. 020-668
Contains 395 Screws.
Complete Coverage.
Refer to page 76.

6-LOBE TRIM SCREWS NO. 020-669
Contains 240 Screws.
Complete Coverage.
Refer to page 77.

FLANGED BOLTS AND NUTS NO. 020-670
Contains 145 Bolts and Nuts.
244-425, 520, 523, 540, 625, 630, 640, 645, 650, 695, 699, 899, 986, 987, 988, 990; 245-122, 225, 325, 516.
Refer to page 93.

MARINE FASTENERS NO. 020-673
Contains 500 pieces.
18.8 Stainless Steel Fasteners.
Tapping Screws — 4 x 1/2; 6 x 3/4; 8 x 3/4, 1"; 10 x 1" — Pan and Oval Slot.
Wood Screws — 6 x 3/4; 8 x 3/4, 1"; 10 x 1", 1-1/2.
Machine Screws — 6-32 x 1/2; 8-32 x 1"; 10-24 x 1-1/2; 1/4-20 x 2".
Nuts — 6-32, 8-32, 10-24, 1/4-20.
Finishing Washers — No. 6, 8, 10, 1/4.
Refer to page 164.

'PALNUT' FASTENERS NO. 020-674
Contains 325 pieces.
242-016, 018, 108, 110, 114, 116, 207, 209, 211, 215, 216, 314, 316, 318, 406, 408, 410, 413; 243-004, 106, 204, 306, 308, 310, 404, 405.
Refer to page 90.

HEADLAMP SCREWS NO. 020-675
General Motors.
Contains 50 Screws and Nuts.
Complete coverage.
Refer to page 105.

HEADLAMP SCREWS NO. 020-676
Chrysler and Ford.
Contains 50 Screws and Nuts.
Complete coverage.
Refer to page 106.

ANCHOR GROMMETS AND NUTS NO. 020-678
Contains 295 Grommets and Nuts.
247-610, 611, 620, 625, 630, 650, 660, 665, 670, 710, 715, 720, 730, 735, 811, 812, 815, 820, 826, 830, 840.
Refer to pages 102, 103.



TRIM FASTENERS NO. 020-679
General Motors.
Contains 150 Fasteners.
247-012, 053, 056, 061, 080, 082, 085, 090, 101, 150, 210, 211, 212, 215, 216, 222, 235, 248, 249, 250.
Refer to pages 100, 101.

TRIM FASTENERS NO. 020-680
Chrysler and Ford.
Contains 150 Fasteners.
247-025, 038, 052, 055, 062, 065, 110, 136, 165, 211, 215, 230, 231, 232, 236, 237, 238, 245, 252, 253.
Refer to pages 100, 101.

REVEAL WINDSHIELD CLIPS NO. 020-681
Contains 125 Clips.
246-409, 410, 411, 412, 413, 414, 415, 416, 417, 418, 419, 420, 425, 426, 427, 428, 429, 435, 436, 438.
Refer to page 98.

PAPCO MASTER ASSORTMENTS



 <p>TRIM FASTENERS NO. 020-682 Import. Contains 100 pieces. 246-350, 351, 352, 353, 354, 355, 356, 357, 358, 359, 360 ; 247-069, 073, 074, 075, 076, 077, 308, 490, 491, 493, 494, 850, 851, 852, 853, 854, 855, 856, 857, 858, 859, 860. Refer to pages 97-104.</p>	 <p>BODY BOLTS NO. 020-691 Contains 150 Bolts. 245-322, 325, 400, 405, 407, 420, 424, 425, 440, 450, 505, 507, 510, 525, 527, 610, 615, 516, 620, 630. Refer to page 92.</p>	 <p>METRIC WASHERS NO. 020-727 Contains 1000 Flat, Lock and Spring Washers. 4mm, 5mm, 6mm, 8mm, and 10 mm of all three types. Refer to page 26.</p>
<p>PCV VALVE GROMMETS NO. 020-683 Contains 42 Grommets. 263-201, 202, 203, 204, 205, 206, 207, 208, 209, 210, 211, 212, 213, 214, 215, 216, 217, 218, 225, 226. Refer to page 124.</p>	<p>'U' NUTS NO. 020-692 Contains 100 Nuts. 240-614, 615, 616, 617, 618, 619, 706, 708, 709, 710, 714, 715 ; 241-604, 605, 606, 607, 608, 609, 610, 612. Refer to page 91.</p>	<p>METRIC SOCKET SET SCREWS AND MACHINE SCREWS NO. 020-728 Contains 100 Set Screws. M4 x 5, 10 ; M5 x 10, 15 ; M6 x 8, 12, 20 ; M8 x 8, 12, 20 ; plus M2, 2.5, 3, 4 Keys. Contains 140 Machine Screws and Nuts. M4 x 6, 12 ; M5 x 10, 16 ; M6 x 10, 16, 20 — Screws. M4, 5, 6 — Nuts. Refer to page 26.</p>
<p>MOULDING CLIPS NO. 020-684 General Motors. Contains 100 Clips. 246-112, 114, 120, 122, 124, 212, 216, 310, 316, 320, 395, 396, 397, 398, 399, 400, 401, 402, 408. Refer to page 97.</p>	<p>'PLASTI-RIVETS' NO. 020-693 Contain 150 Rivets. 247-300, 301, 302, 303, 304, 305, 306, 307, 401, 402, 403, 405, 406, 407, 411, 462, 464, 466, 467, 468. Refer to pages 82, 104.</p>	<p>METRIC COTTER AND SPRING PINS NO. 020-729 Contains 675 Cotter Pins. 1.5 x 16 ; 2 x 20 ; 3 x 25, 40 ; 4 x 50. Contains 160 Spring Pins. 2 x 16 ; 2.5 x 18 ; 3 x 24, 40 ; 4 x 18, 36, 50 ; 5 x 36, 50 ; 6 x 22, 50. Refer to page 26.</p>
<p>GREASE FITTINGS NO. 020-685 Contains 160 Inch and Metric Fittings. 904-610, 612, 613, 363, 641, 652, 688, 691, 701, 702, 703, 745, 746, 747, 790, 791, 792. Refer to page 171.</p>	<p>METRIC CAP SCREWS AND NUTS NO. 020-725 Contains 570 Cap Screws and Nuts. M4 x 16 ; M5 x 12, 16, 20, 25 ; M6 x 12, 16, 20, 25, 30, 35, 45 — Cap Screws M4, 5, 6 — Nuts and Lock Nuts. Refer to page 26.</p>	<p>METRIC COTTER AND SPRING PINS NO. 020-729 Contains 675 Cotter Pins. 1.5 x 16 ; 2 x 20 ; 3 x 25, 40 ; 4 x 50. Contains 160 Spring Pins. 2 x 16 ; 2.5 x 18 ; 3 x 24, 40 ; 4 x 18, 36, 50 ; 5 x 36, 50 ; 6 x 22, 50. Refer to page 26.</p>
<p>MOULDING CLIPS NO. 020-688 Chrysler and Ford. Contains 100 Clips. 246-112, 120, 122, 124, 126, 218, 222, 226, 228, 230, 320, 324, 400, 403, 405, 407. Refer to page 97.</p>	<p>METRIC CAP SCREWS AND NUTS NO. 020-726 Contains 186 Cap Screws and Nuts. M8 x 12, 16, 20, 25, 30, 40, 60, 70 ; M10 x 30, 40, 50, 60, 70 — Cap Screws M8, 10 — Nuts and Lock Nuts. Refer to page 26.</p>	<p>METRIC CAP SCREWS AND NUTS NO. 020-730 Fine and Extra Fine Thread. Contains 130 Cap Screws and Nuts. 609-320, 324, 368, 370, 372, 374, 416, 418 ; 610-366, 368, 372, 374, 414, 416, 418 ; 670-208, 210, 212, 750, 765, Refer to page 26.</p>

PAPCO STAX-SIX CABINET No. 022-091

'Papco' Stax-Six Cabinet No. 022-091 holds six Master Assortments in its own rigid drawer slide. Made of heavy gauge steel with a baked-on enamel finish. Size: 15-1/2" h. x 11-3/4" d.



(Assortments or Assortment Drawers NOT included.)

- Assortments are packed in a sturdy, metal container with high-strength, moulded plastic compartments and hinged lid .
- Individual compartments separate items for quick selection.
- Illustrations and retail price codes shown on grease-resistant lid label.
- Curved, 'coin-drawer' bottom makes removal easy.
- Refill available in standard packages or 'Papco' Handy-Paks.
- Carrying handle and safety snap lock for greater convenience.
- Merchandiser size:
9-3/4" w. x 13-3/4" l. x 2" d.



Papco 'SUPER-SERVICE' ASSORTMENTS

Perfect for Dealers, Jobbers and large users. These popular assortments have a wide range of carefully selected items in balanced quantities.

Papco STAX FOUR CABINET No. 022-093

- Welded steel construction.
- Rigid drawer slide.
- Baked black enamel finish.
- No-spill safety feature.







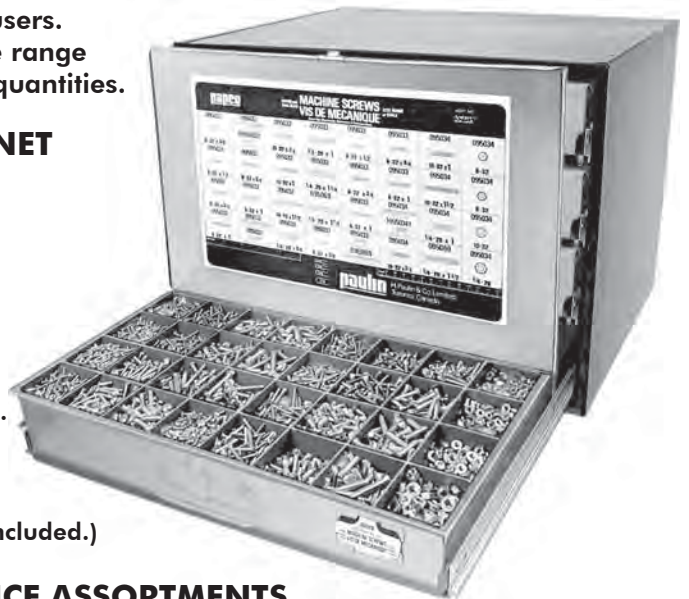



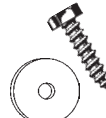











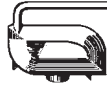
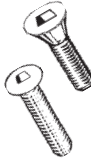

Each 'Papco' STAX-FOUR Cabinet holds four Super-Service Assortments.

Stax-Four Cabinet No. 022-093
Size: 20" w. x 14-1/2" h. x 15-3/4" d.

(Assortments or Assortment Drawers NOT included.)

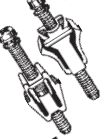

SUPER SERVICE ASSORTMENTS

 <p>EXPANSION PLUGS NO. 020-800 Contains 200 Standard and Cup Types. 260-008, 010, 014, 018, 020, 024, 028, 030, 036, 039, 045, 054, 057, 114, 120, 130, 142, 144, 159, 165, 168, 174, 177, 180, 186, 194, 198, 204, 240. Refer to page 121.</p>	 <p>TAPPING SCREWS NO. 020-808 Contains 650 Hex Head Tapping Screws and Fender Washers. Complete coverage of Hex Head Tapping Screws. Fender Washers — 162-394, 395, 396, 397, 398, 399. Refer to page 69.</p>	 <p>SNAP RINGS NO. 020-817 Contains 705 Snap Rings - 50 Sizes. Complete coverage 268-222 to 724. Refer to page 126.</p>
 <p>EXPANSION PLUGS NO. 020-801 Contains 170 Cup and Shallow Cup Types. 260-114, 118, 120, 130, 142, 144, 159, 165, 168, 174, 177, 180, 186, 194, 198, 204, 207, 219, 240, 311, 318, 327, 333, 339, 351, 365, 368, 370, 372, 378. Refer to page 121.</p>	 <p>PHILLIPS TRIM SCREWS NO. 020-809 Contains 1225 Phillips Screws. 229-010, 012, 022, 024, 026, 044, 110, 120, 122, 140, 142, 164, 220, 222, 224, 226, 228, 240, 242, 244, 248, 250, 252 ; 230-203, 205, 207, 301, 302, 304, 305. Refer to page 74.</p>	 <p>ENGINE STUDS AND NUTS NO. 020-818 Contains 295 Engine Studs and Nuts. Studs — 264-018, 024, 032, 048, 049, 060, 066, 086, 088, 094, 096, 134, 150. Metric Studs — 264-231, 328, 335, 338, 346, 443, 450, 451. Nuts — 264-953, 954, 955, 956, 958, 959, 960, 961. Metric Nuts — 670-006, 008, 010. Refer to page 115.</p>
 <p>WHEEL PARTS NO. 020-802 Contains 180 Bolts and Nuts. Universal. 558-014, 016, 027 ; 559-125, 150 ; 560-102, 103, 105, 114, 138, 148, 155, 167, 172, 173, 386, 604 ; 561-100, 102, 106, 108, 109, 110, 111, 120, 129, 154, 166, 167, 212, 248, 251. Refer to page 154.</p>	 <p>SPEED NUTS NO. 020-810 Contains 685 Speed Nuts in Flat, Push-on and Formed Types. 240-090, 091, 097, 100, 101, 107, 120, 121, 125, 127, 160, 210, 220, 227, 228, 243, 245, 246, 247, 248, 249, 260, 263, 267, 268, 335, 350, 355, 360, 365, 370. Refer to page 88.</p>	 <p>SPRING PINS NO. 020-819 Contains 770 Spring Pins. 1/16 x 1/2, 3/4, 1" ; 3/32 x 1/2, 3/4, 1" ; 1/8 x 3/8, 1/2, 3/4, 1" ; 1-1/4, 1-1/2, 2" ; 5/32 x 1/2, 3/4, 1" ; 1-1/2 ; 3/16 x 1/2, 3/4, 1" ; 1-1/2, 2" ; 1/4 x 3/4, 1", 1-1/2, 2" ; 5/16 x 1", 1-1/2, 2" ; 3/8 x 1", 1-1/2, 2". Refer to page 133.</p>
 <p>SOCKET SET SCREWS NO. 020-803 Contains 240 Set Screws and Keys. Complete coverage of Socket Set Screws plus 140-101, 102, 103, 104, 107, 108, 110, and 111 Hex Keys. Refer to pages 40-42.</p>	 <p>PALNUT FASTENERS NO. 020-811 Contains 500 Regular and Self-Threading Palnuts plus Bolt Retainers and Pushnuts. 242-016, 018, 020, 022, 110, 114, 116, 206, 207, 208, 209, 210, 211, 214, 215, 216, 314, 316, 318, 406, 408, 410, 414, 416, 418 ; 243-004, 106, 204, 306, 308, 310, 404. Refer to page 90.</p>	 <p>WOODRUFF KEYS NO. 020-820 Contains 374 Woodruff Keys. 302-010, 020, 030, 040, 050, 060, 061, 070, 080, 090, 091, 100, 110, 120, 121, 130, 140, 150, 152, 160, 170, 180, 183, 190, 200, 210, 214, 220, 240, 250, 270, 280. Refer to page 134.</p>
 <p>FLAT AND LOCK WASHERS NO. 020-804 Contains 3020 Plain, S.A.E., Lock, Tooth Lock and Fender Washers. Flat — 3/16, 1/4, 5/16, 3/8, 7/16, 1/2. S.A.E. — No. 8, 10, 1/4, 5/16, 3/8, 7/16, 1/2. Lock — No. 8, 10, 1/4, 5/16, 3/8, 7/16, 1/2. Int. Tooth — 3/16, 1/4, 5/16, 3/8. Ext. Tooth — 3/16, 1/4, 5/16, 3/8. Fender — 162-395, 396, 398, 399. Refer to page 56.</p>	 <p>WIRING TERMINALS NO. 020-812 Contains 500 Terminals. Complete coverage. Refer to page 156.</p>	 <p>UNIVERSAL O-RINGS NO. 020-821 Contains 390 O-Rings. Complete coverage. Refer to page 135.</p>
 <p>COTTER PINS NO. 020-805 Contains 3345 Cotter Pins and Throttle Rod Retainers. 1/16 x 1/2, 3/4, 1", 1-1/4, 1-1/2 ; 3/32 x 3/4, 1", 1-1/4, 2" ; 1/8 x 3/4, 1", 1-1/4, 1-1/2, 1-3/4, 2" ; 5/32 x 1", 1-1/4, 1-1/2, 2" ; 3/16 x 1", 1-1/4, 1-1/2, 2". Retainers — 262-203, 205, 206, 208, 210, 214, 216, 218. Refer to page 47.</p>	 <p>TRIM FASTENERS NO. 020-813 Contains 300 Trim and Weatherstrip Fasteners plus Shield Retainers. Complete coverage (except 247-026). Refer to page 101.</p>	 <p>MOULDING BOLTS NO. 020-822 Universal. Contains 195 Moulding Bolts. Complete coverage 246-112 to 324. Refer to page 96.</p>
 <p>MACHINE SCREWS AND NUTS NO. 020-806 Contains 2750 Round and Flat Sq. Drive Screws and Nuts. Round — 6-32 x 3/8, 1/2, 3/4, 1", 1-1/2 ; 8-32 x 1/2, 3/4, 1", 1-1/2 ; 10-32 x 1/2, 3/4, 1", 1-1/2 ; 1/4-20 x 3/4, 1", 1-1/4, 1-1/2. Flat — 6-32 x 3/8, 1/2, 3/4, 1", 1-1/2 ; 8-32 x 1/2, 3/4, 1", 1-1/2 ; 10-32 x 1/2, 3/4, 1", 1-1/2 ; 1/4-20 x 1", 1-1/2. Nuts — 6-32, 8-32, 10-32, 1/4-20. Refer to page 64.</p>	 <p>ANCHOR GROMMETS AND NUTS NO. 020-814 Contains 465 Grommets and Nuts. 247-610, 611, 615, 620, 621, 650, 655, 660, 665, 670, 710, 715, 720, 725, 730, 735, 810, 811, 812, 815, 820, 826, 830, 840, 821, 825. Refer to page 102-103.</p>	 <p>'U' NUTS AND BODY BOLTS NO. 020-823 Contains 329 'U' Nuts and Body Bolts. Complete coverage of 240-614 to 715 and 245-322 to 616. Refer to page 88.</p>
 <p>TAPPING SCREWS NO. 020-807 Contains 1450 Pan & Oval Slot Tapping Screws. Pan — 6 x 3/8, 1/2, 3/4, 1", 1-1/4 ; 8 x 3/8, 1/2, 3/4, 1", 1-1/4, 1-1/2 ; 10 x 1/2, 3/4, 1", 1-1/4, 1-1/2 ; 12 x 3/4, 1", 1-1/4 ; 14 x 1", 1-1/4 ; 6 x 1/2, 3/4, 1" ; 8 x 1/2, 3/4, 1" ; 10 x 3/4, 1", 1-1/4 ; 12 x 1-1/2. Refer to page 68.</p>	 <p>HEADLAMP SCREWS NO. 020-815 Universal. Contains 105 Screws and Nuts. 247-615, 621, 665, 816, 830 ; 248-010, 015, 016, 020, 025, 026, 031, 032, 033, 035, 040, 045, 050, 055, 060, 110, 115, 116, 120, 121, 125, 210, 215, 220, 225, 226. Refer to page 106.</p>	 <p>METRIC EXPANSION PLUGS NO. 020-840 Contains 180 Metric Standard and Cup Types. 261-014, 024, 026, 046, 064, 090, 100, 107, 109, 114, 117, 124, 126, 132, 138, 145, 146, 149, 150, 155, 161, 165, 177, 182, 184, 185, 186, 188. Refer to page 121.</p>
	 <p>CLEVISS PINS AND CLIPS NO. 020-816 Contains 173 Standard and Universal Cleviss Pins and Clips. 255-004, 054, 064, 074, 076, 084, 086, 106, 126, 208, 221, 224, 226, 228, 231, 235, 236, 237, 239, 241, 242, 244, 246, 251 ; Hitch Pins — 255-303, 307, 310, 311, 316. Cotter Pins — 1/16 x 1/2 ; 3/32 x 3/4 ; 1/8 x 1". Refer to page 45.</p>	 <p>METRIC CAP SCREWS AND NUTS NO. 020-842 Contains 535 Metric Cap Screws and Nuts. 608-139, 198, 201, 203, 205, 267, 270, 272, 274, 276, 278, 279, 311, 314, 316, 318, 320, 321, 322, 324, 326, 328, 370, 372, 374, 376, 378 ; 670-004, 005, 006, 008, 010. Refer to pages 24, 26.</p>

Note: Contents of assortments subject to change with market

papco[®] BOLT BINS

COFFRE POUR BOULONS



Store your Cap Screws, Nuts and other fasteners in these modern, all-steel 'Papco' Bolt Bins. Every item is easy to see - your stock is kept clean, neat and always available.

40

No. 022-017 (empty)
36" wide x 24" high x 12" deep
40 Bins Size: 4-1/2 x 4-1/2 x 12

42

No. 022-018 (empty)
36" wide x 42" high x 12" deep
42 Bins Size: 5-3/8 x 5-7/16 x 12

72

No. 022-019 (empty)
36" wide x 42" high x 12" deep
72 Bins Size: 4-1/2 x 4-1/2 x 12

FEATURES

OPTIONAL STEEL DOORS
with Chrome Handles
and Magnetic Catches.

No. 022-023 for Bolt Bin No. 022-017
No. 022-025 for Bolt Bin No. 022-018
and 019

HEAVY GAUGE STEEL
Welded Construction.

'SAFETY' BIN LIPS
Avoid Spillage.

BAKED FINISH

OPTIONAL STEEL BASE
4 Inches High, Black Finish.

022-027 Base fits either model.



papco[®] MOD-U-BIN

Build a 'Papco' Bolt Bin as large as you need. New modular design allows you to mount additional bins to the top, bottom or sides.

- Heavy gauge steel construction.
- 12 Large hand size compartments.
- Baked orange enamel finish.
- Label holder rails.

Mount anywhere, on the wall, on a workbench or on the floor.

12

No. 022-020 (empty)
17" w. x 16-1/2" h. x 6-1/4" d.
12 Bins Size: 4-1/4 x 5-1/2 x 6-1/4



PAPCO BOLT BIN ASSORTMENTS ASSORTIMENTS DE BOULONS



PLATED GRADE 5 CAP SCREWS AND NUTS No. 022-021

72 Popular Sizes - Over 4,750 Pieces.

UNC Cap Screws		UNC Cap Screws		UNF Cap Screws	
100	1/4 x 3/4	25	5/8 x 4	25	5/8 x 2
100	1/4 x 1	25	5/8 x 5	25	5/8 x 3
100	1/4 x 1-1/2	20	3/4 x 2-1/2	25	5/8 x 4
100	5/16 x 3/4	20	3/4 x 3	20	3/4 x 3
100	5/16 x 1	20	3/4 x 4	20	3/4 x 4
100	5/16 x 1-1/2	20	3/4 x 5	UNC Hex Nuts	
100	5/16 x 2	20	3/4 x 6	300	1/4
100	3/8 x 1	20	7/8 x 2-1/2	200	5/16
100	3/8 x 1-1/2	20	7/8 x 3	200	3/8
100	3/8 x 2	20	7/8 x 4	50	7/16
100	3/8 x 2-1/2	20	1 x 3	50	1/2
100	3/8 x 3	10	1 x 4	25	9/16
50	7/16 x 1-1/2	UNC Cap Screws		25	5/8
50	7/16 x 2	100	1/4 x 1	20	3/4
50	7/16 x 3	100	1/4 x 1-1/2	20	7/8
50	1/2 x 1	100	5/16 x 1	20	1
50	1/2 x 1-1/2	100	5/16 x 1-1/2	UNF Hex Nuts	
50	1/2 x 2	100	5/16 x 2	200	1/4
50	1/2 x 2-1/2	100	3/8 x 1	200	5/16
50	1/2 x 3	100	3/8 x 2	200	3/8
50	1/2 x 4	50	7/16 x 1-1/2	100	7/16
25	9/16 x 2	50	1/2 x 2	50	1/2
25	5/8 x 2	50	1/2 x 3	25	9/16
25	5/8 x 2-1/2	50	1/2 x 4	25	5/8
25	5/8 x 3	25	9/16 x 2	20	3/4



Size: 36" x 42" x 12"
DOORS AND BASE ARE OPTIONAL EXTRAS

These assortments include a set of Bolt Bin Stock Labels with space for inventory control or prices; a 'Papco' Measurement and Decimal Equivalents Chart, and Popular Fastener Order Forms.

You can also purchase 'Papco' Bolt Bins empty and make up your own custom assortments. You have the option of ordering the Doors and Base as extra items. As your requirements grow, you can add more Bolt Bins to store other Fasteners and Supplies.

PLATED GRADE 5 CAP SCREWS AND NUTS No. 022-022

40 Popular Sizes - Over 4,000 Pieces.

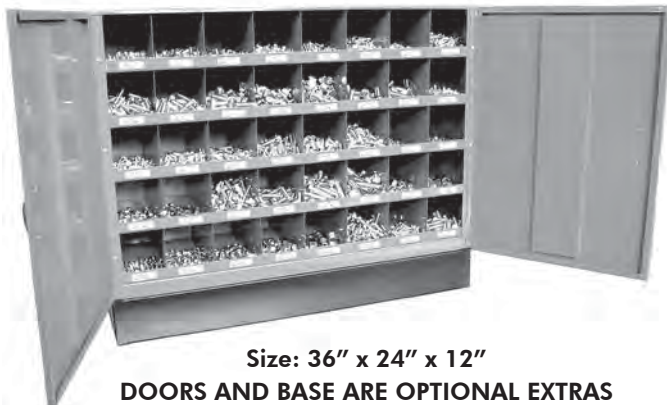

Size: 36" x 24" x 12"
DOORS AND BASE ARE OPTIONAL EXTRAS

UNC Cap Screws		UNC Cap Screws		UNC Hex Nuts	
100	1/4 x 3/4	25	5/8 x 2	200	1/4
100	1/4 x 1	25	5/8 x 3	100	5/16
100	1/4 x 1-1/2	UNF Cap Screws		100	3/8
100	5/16 x 3/4	100	1/4 x 1	100	7/16
100	5/16 x 1	100	1/4 x 1-1/2	100	1/2
100	5/16 x 1-1/2	100	5/16 x 3/4	50	9/16
200	3/8 x 1	200	5/16 x 1	25	5/8
200	3/8 x 1-1/2	100	5/16 x 1-1/2	UNF Hex Nuts	
200	3/8 x 2	100	3/8 x 1	200	1/4
100	7/16 x 1-1/2	100	3/8 x 1-1/2	100	5/16
100	1/2 x 1-1/2	100	3/8 x 2	100	3/8
100	1/2 x 2	100	7/16 x 1-1/2	100	7/16
100	1/2 x 2-1/2	50	1/2 x 2	100	1/2
25	9/16 x 1-1/2	50	1/2 x 2-1/2		
25	9/16 x 2				

papco BOLT-N-NUT CABINET



The `Papco` Bolt-n-Nut Cabinet was developed for Service Stations, Garages, Car Dealers, Body Shops and many other fastener users. Each compact space-saving cabinet features:



Size: 34" w. x 11" h. x 11-5/8" d.

No. 022-086 (Empty)

- All steel construction.
- 18 Man-size, no-spill drawers (11-1/4" l. x 5-1/2" w. x 3" d.)
- Colour-coded labels for ease of identification.
- Full width handles.
- Multi-divisible drawers for future additions.
- Can be mounted on bench or placed in a standard three foot shelf.

papco BOLT-N-NUT CABINET MERCHANDISERS

Merchandiser No. 022-098 INCH EXPANSION PLUGS

Includes 54 items (see page 121) one empty cabinet No. 022-086, labels and instructions

Merchandiser No. 022-099 METRIC EXPANSION PLUGS

Includes 54 items (see page 121) one empty cabinet No. 022-086, labels and instructions

Merchandiser No. 022-084 PLATED BOLTS-n-NUTS

Includes 47 items as listed below, one empty cabinet No. 022-086, labels and instructions

Merchandiser No. 022-085 BARE BOLTS-n-NUTS

Includes 47 items as listed below, one empty cabinet No. 022-086, labels and instructions

Merchandiser No. 022-087 PLATED METRIC FASTENERS

Includes 52 items as listed below, one empty cabinet No. 022-086, labels and instructions

UNC Grade 5 Cap Scr.		UNF Grade 5 Cap Scr.		Flat Washers	
100	1/4 x 3/4	100	5/16 x 3/4	100	5/16
100	1/4 x 1	100	5/16 x 1	100	3/8
100	1/4 x 1-1/2	100	5/16 x 1-1/2	100	7/16
100	5/16 x 3/4	100	3/8 x 1	100	1/2
100	5/16 x 1	100	3/8 x 1-1/2	Lock Washers	
100	5/16 x 1-1/2	100	3/8 x 2	100	1/4
100	3/8 x 1	UNC Hex Nuts		100	5/16
100	3/8 x 1-1/2	100	1/4	100	3/8
100	3/8 x 2	100	5/16	100	7/16
50	7/16 x 1-1/2	100	3/8	100	1/2
50	7/16 x 2	50	7/16	R.H. Stove Bolts	
50	1/2 x 1-1/2	50	1/2	100	3/16 x 1
50	1/2 x 2	UNF Hex Nuts		100	3/16 x 1-1/2
50	1/2 x 2-1/2	100	1/4	100	1/4 x 1
UNF Grade 5 Cap Scr.		100	5/16	Cotter Pins	
100	1/4 x 3/4	100	3/8	100	3/32 x 1-1/2
100	1/4 x 1	Flat Washers		100	1/8 x 1-1/2
100	1/4 x 1-1/2	100	1/4	100	1/8 x 2

Cap Screws		Cap Screws		Lock Washers	
100	M4 x 16	50	M10 x 30	100	6mm
100	M5 x 12	50	M10 x 40	100	8mm
100	M5 x 16	50	M10 x 50	100	10mm
100	M5 x 20	25	M10 x 60	Fine & Extra Fine Cap Screws and Nuts	
100	M5 x 25	25	M10 x 70	10	M8 x 1
100	M6 x 12	Hex Nuts		10	M10 x 1
100	M6 x 16	100	M4	10	M10 x 1.25
100	M6 x 20	100	M5	10	M12 x 1.25
100	M6 x 25	100	M6	10	M12 x 1.5
100	M6 x 30	100	M8	Stove Bolts	
100	M6 x 35	100	M10	100	M4 x 6
100	M8 x 12	Flat Washers		100	M4 x 12
100	M8 x 16	100	4mm	100	M5 x 10
100	M8 x 20	100	5mm	100	M5 x 16
100	M8 x 25	100	6mm	100	M6 x 10
100	M8 x 30	100	8mm	100	M6 x 16
50	M8 x 40	100	10mm	100	M6 x 20
50	M8 x 50	Lock Washers			
25	M8 x 60	100	4mm		
25	M8 x 70	100	5mm		

Optional steel drawer dividers No. 022-088 for above cabinet. Standard Package contains 12 dividers.



papeo BULK BINS

Durable Polypropylene, coloured bins are stackable and can be divided to hold more than one part. Standard Package 12 Bins.

Stock No.	Colour	W	D	H
022-263	Blue	6 ⁵ / ₈ "	18"	4"
022-264	Red	6 ⁵ / ₈ "	18"	4"
022-265	Yellow	6 ⁵ / ₈ "	18"	4"
022-266	Green	6 ⁵ / ₈ "	18"	4"
022-267	Orange	6 ⁵ / ₈ "	18"	4"
022-268	Blue	6 ⁵ / ₈ "	11 ⁵ / ₈ "	4"
022-269	Red	6 ⁵ / ₈ "	11 ⁵ / ₈ "	4"
022-270	Yellow	6 ⁵ / ₈ "	11 ⁵ / ₈ "	4"
022-271	Black	Bin dividers		

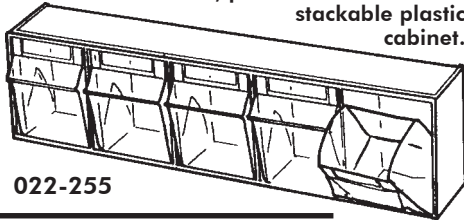
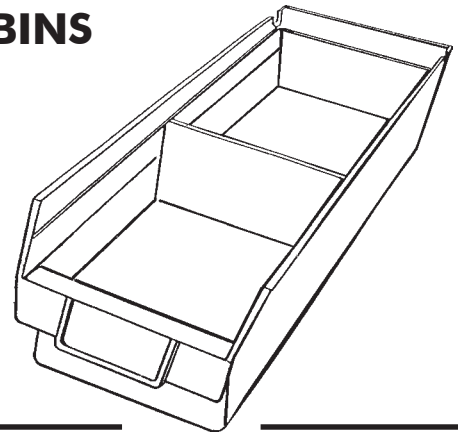

Clear, plastic tilt-out bins in a stackable plastic cabinet.

022-255

CLEAR PLASTIC BINS

Stock No.	Description	W	D	H
022-259	9 Compartment Tilt-Bin	23 ⁵ / ₈ "	2 ¹ / ₂ "	3 ⁵ / ₁₆ "
022-256	6 Compartment Tilt-Bin	23 ⁵ / ₈ "	3 ⁵ / ₈ "	4 ¹ / ₂ "
022-255	5 Compartment Tilt-Bin	23 ⁵ / ₈ "	5 ¹ / ₄ "	6 ¹ / ₂ "
022-254	4 Compartment Tilt-Bin	23 ⁵ / ₈ "	6 ⁵ / ₈ "	8 ¹ / ₈ "
022-253	3 Compartment Tilt-Bin	23 ⁵ / ₈ "	7 ³ / ₄ "	9 ¹ / ₂ "

papeo PLASTIC SERVICE BINS

- **DURABLE**
Frames are of heavy steel construction for long life.
- **EASY TO REMOVE**
Carry bin to the job.
- **EASY TO CLEAN**
Individual Hook-on Bins lift out.
- **EASY TO RE-ARRANGE**
Add new stock sizes as required.
- **COMPLETELY VISIBLE**
Bins have forward tilt.
- **COMPLETELY ACCESSIBLE**
Coin drawer bin bottom for easy parts removal.
- **EASY TO SERVICE**
Stock can be checked and refilled.
- **VERSATILE**
Sold empty - Choice of 5 sizes of Racks.
Free Label Service.

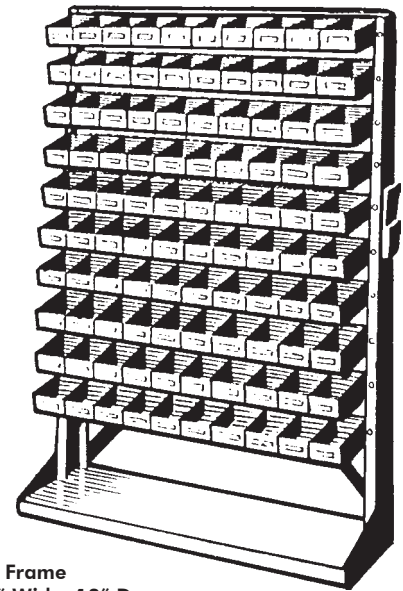

022-045
100 Bins and Frame
56" High, 41" Wide, 12" Deep

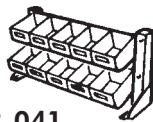

022-041
10 Bins and Frame
10" High, 21¹/₂" Wide, 8" Deep

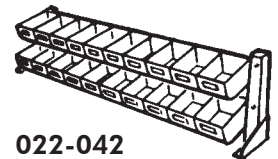

022-042
20 Bins and Frame
10" High, 41" Wide, 8" Deep

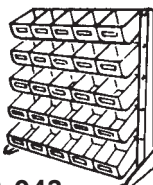

022-043
25 Bins and Frame
23" High, 21¹/₂" Wide, 8" Deep



INDIVIDUAL HOOK-ON PLASTIC BINS
022-040
Empty Service Bin
7" Long, 3³/₄" Wide, 2³/₄" Deep

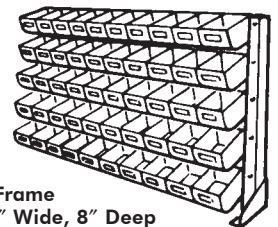

022-044
50 Bins and Frame
23" High, 41" Wide, 8" Deep

Papco HANDY-PAKS

JOBBER MERCHANDISER No. 022-067

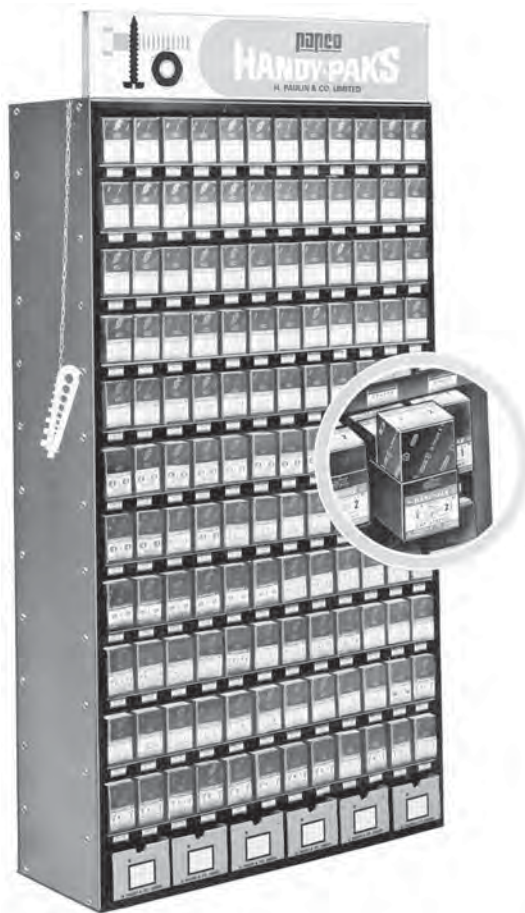

Contains 792 Handy-Packs, Rack and sign. 132 Sizes of Cap Screws, Nuts, Washers, Cotter Pins, Stove Bolts, etc.

UNIFORM PRICED PACKAGES OF FAST-MOVING HARDWARE ITEMS

- All Bright Plated Material
- No Broken Boxes
- Good For Regular Stock
- Ideal For Assortment Refills
- Best Value
- Fully Illustrated, Colour-Coded Labels



'Papco' Handy-Paks are the most modern method of stocking fasteners. They contain the most popular sizes of Bolts, Nuts, Screws and Washers as well as the best sizes of replacement parts. The available merchandisers are designed to give maximum coverage for a minimum investment.

HANDY-PAK MERCHANDISER No. 022-067 CONTENTS

Part No.	Size	Qty.	Part No.	Size	Qty.	Part No.	Size	Qty.	Part No.	Size	Qty.
UNF Grade 5 Cap Screws			UNC Grade 5 Cap Screws			UNC Hex Nuts			023-307	1/2	6
023-101	1/4 x 1/2	6	023-018	5/16 x 1	12	023-203	3/8	12	023-309	5/8	6
023-103	1/4 x 3/4	6	023-019	5/16 x 1-1/4	6	023-204	7/16	12	Cotter Pins		
023-105	1/4 x 1	6	023-020	5/16 x 1-1/2	12	023-205	1/2	6	023-703	1/16 x 1	6
023-107	1/4 x 1-1/2	6	023-022	5/16 x 2	6	023-207	5/8	6	023-705	1/16 x 1-1/2	6
023-109	1/4 x 2	6	023-029	3/8 x 3/4	6	Round Head Stove Bolts			023-709	3/32 x 1	6
023-116	5/16 x 3/4	6	023-031	3/8 x 1	12	023-502	3/16 x 3/4	6	023-710	3/32 x 1-1/4	6
023-118	5/16 x 1	12	023-032	3/8 x 1-1/4	12	023-503	3/16 x 1	6	023-711	3/32 x 1-1/2	6
023-119	5/16 x 1-1/4	6	023-033	3/8 x 1-1/2	12	023-505	3/16 x 1-1/2	6	023-715	1/8 x 1	6
023-120	5/16 x 1-1/2	6	023-035	3/8 x 2	12	023-511	1/4 x 3/4	6	023-716	1/8 x 1-1/4	6
023-122	5/16 x 2	6	023-037	3/8 x 2-1/2	6	023-512	1/4 x 1	6	023-717	1/8 x 1-1/2	12
023-131	3/8 x 1	6	023-042	7/16 x 1	6	Lock Washers			023-718	1/8 x 2	12
023-132	3/8 x 1-1/4	6	023-043	7/16 x 1-1/4	6	023-342	3/16	6	023-722	5/32 x 1-1/2	6
023-133	3/8 x 1-1/2	6	023-044	7/16 x 1-1/2	6	023-343	1/4	6	023-723	5/32 x 2	6
023-135	3/8 x 2	6	023-046	7/16 x 2	6	023-344	5/16	12	Hex Machine Screw Nuts		
023-137	3/8 x 2-1/2	6	023-048	7/16 x 2-1/2	6	023-345	3/8	12	023-462	10-32	6
023-144	7/16 x 1-1/2	6	023-053	1/2 x 1	6	023-346	7/16	6	Pan Head Sheet Metal Screws		
023-146	7/16 x 2	6	023-054	1/2 x 1-1/4	6	023-347	1/2	6	023-605	6 x 1/2	6
023-153	1/2 x 1	6	023-055	1/2 x 1-1/2	6	023-349	5/8	6	023-612	8 x 1/2	6
023-155	1/2 x 1-1/2	6	023-057	1/2 x 2	6	S.A.E. Washers			023-614	8 x 3/4	6
023-157	1/2 x 2	6	023-059	1/2 x 2-1/2	6	023-323	1/4	12	023-616	8 x 1	6
023-159	1/2 x 2-1/2	6	UNF Hex Nuts			023-324	5/16	12	023-618	10 x 1/2	6
UNC Grade 5 Cap Screws			023-221	1/4	12	023-325	3/8	12	023-619	10 x 3/4	6
023-001	1/4 x 1/2	6	023-222	5/16	12	023-326	7/16	6	023-621	10 x 1	6
023-003	1/4 x 3/4	12	023-223	3/8	12	023-327	1/2	6	023-628	14 x 3/4	6
023-005	1/4 x 1	6	023-224	7/16	6	Plain Steel Washers			023-629	14 x 1	6
023-006	1/4 x 1-1/4	6	023-225	1/2	6	023-302	3/16	6	Oval Head Sheet Metal Screws		
023-007	1/4 x 1-1/2	6	023-227	5/8	6	023-303	1/4	6	023-651	10 x 1	6
023-009	1/4 x 2	6	UNC Hex Nuts			023-304	5/16	6	Hex Head Sheet Metal Screws		
023-014	5/16 x 1/2	6	023-201	1/4	12	023-305	3/8	6	023-673	14 x 3/4	6
023-016	5/16 x 3/4	12	023-202	5/16	12	023-306	7/16	6	023-677	5/16 x 1	6



papco FASTENER CENTRE CENTRE DE BOULONNERIE

No. 022-075



**‘Fastener Centre’
Merchandiser No. 022-075
(Complete as illustrated)**

The ‘Papco’ Fastener Centre enables every Jobber to carry the widest possible coverage of bolts, nuts and screws for the lowest possible investment.

Included are 312 Handy-Paks (104 items with a Starter Stock of 3 paks per item) of Grade 5 Cap Screws, Hex Nuts, Flat Washers, Lock Washers, Tapping Screws, Machine Screws, Stove Bolts and Cotter Pins - plus 12 Master Assortments (240 coin-drawer compartments) of replacement parts such as Wheel Bolts, Frost Plugs, Woodruff Keys, O-Rings, Spring Pins and more.

Each durable, long lasting merchandiser is of all-steel construction with a baked-on, black enamel finish and features two built-in Stax-Six cabinets with master assortments that slide out for easy access. A handy bolt measuring gauge in both inch and metric sizes and an attractive, three-colour sign are also included.

The complete ‘Fastener Centre’ - designed to save time, improve efficiency and increase profits.

For complete list of contents of Merchandiser No. 022-075 see reverse side.

MERCHANDISER No. 022-075 CONTENTS



UNC GRADE 5 HEXAGON HEAD CAP SCREW					
Size	Handy-Pak No.	Size	Handy-Pak No.	Size	Handy-Pak No.
1/4 x 3/4	023-003	5/16 x 2	023-022	7/16 x 1	023-042
1/4 x 1	023-005	5/16 x 2-1/2	023-024	7/16 x 1-1/2	023-044
1/4 x 1-1/2	023-007			7/16 x 2	023-046
1/4 x 2	023-009	3/8 x 1	023-031		
		3/8 x 1-1/4	023-032	1/2 x 1-1/2	023-055
5/16 x 1/2	023-014	3/8 x 1-1/2	023-033	1/2 x 2	023-057
5/16 x 3/4	023-016	3/8 x 2	023-035	1/2 x 3	023-060
5/16 x 1	023-018	3/8 x 2-1/2	023-037		
5/16 x 1-1/2	023-020	3/8 x 3	023-038		
UNF GRADE 5 HEXAGON HEAD CAP SCREW					
Size	Handy-Pak No.	Size	Handy-Pak No.	Size	Handy-Pak No.
1/4 x 1	023-105	5/16 x 1-1/2	023-120	3/8 x 1-1/2	023-133
1/4 x 1-1/2	023-107	5/16 x 2	023-122	3/8 x 2	023-135
5/16 x 3/4	023-116	3/8 x 1	023-131	1/2 x 1-1/2	023-155
5/16 x 1	023-118	3/8 x 1-1/4	023-132	1/2 x 2	023-157
UNC HEXAGON NUTS PLATED					
Size	Handy-Pak No.	Size	Handy-Pak No.	Size	Handy-Pak No.
1/4	023-201	3/8	023-203	1/2	023-205
5/16	023-202	7/16	023-204		
UNF HEXAGON NUTS PLATED					
Size	Handy-Pak No.	Size	Handy-Pak No.	Size	Handy-Pak No.
1/4	023-221	3/8	023-223	1/2	023-225
5/16	023-222	7/16	023-224		
FLAT WASHERS PLATED					
Size	Handy-Pak No.	Size	Handy-Pak No.	Size	Handy-Pak No.
3/16	023-302	5/16	023-304	7/16	023-306
1/4	023-303	3/8	023-305	1/2	023-307
LOCK WASHERS PLATED					
Size	Handy-Pak No.	Size	Handy-Pak No.	Size	Handy-Pak No.
3/16	023-342	5/16	023-344	7/16	023-346
1/4	023-343	3/8	023-345	1/2	023-347
ROUND HEAD (SOCKET) MACHINE SCREWS					
Size	Handy-Pak No.	Size	Handy-Pak No.	Size	Handy-Pak No.
6-32 x 3/4	023-404	8-32 x 1	023-412	10-32 x 1-1/2	023-421
6-32 x 1	023-405	8-32 x 1-1/2	023-414	1/4 x 3/4	023-424
6-32 x 1-1/2	023-407	10-32 x 3/4	023-418	1/4 x 1	023-425
8-32 x 3/4	023-411	10-32 x 1	023-419		
HEXAGON MACHINE NUTS					
Size	Handy-Pak No.	Size	Handy-Pak No.	Size	Handy-Pak No.
6-32	023-460	8-32	023-461	10-32	023-462
ROUND HEAD STOVE BOLTS					
Size	Handy-Pak No.	Size	Handy-Pak No.	Size	Handy-Pak No.
3/16 x 3/4	023-502	3/16 x 2	023-507	1/4 x 1-1/2	023-514
3/16 x 1	023-503	1/4 x 3/4	023-511	1/4 x 2	023-516
3/16 x 1-1/2	023-505	1/4 x 1	023-512		
PAN HEAD (SOCKET) TAPPING SCREWS					
Size	Handy-Pak No.	Size	Handy-Pak No.	Size	Handy-Pak No.
4 x 1/2	023-602	8 x 1/2	023-612	10 x 3/4	023-619
6 x 1/2	023-605	8 x 3/4	023-614	10 x 1	023-621
6 x 3/4	023-607	8 x 1	023-616	14 x 1	023-629
HEXAGON HEAD TAPPING SCREWS					
Size	Handy-Pak No.	Size	Handy-Pak No.	Size	Handy-Pak No.
8 x 1/2	023-665	5/16 x 1	023-677		
10 x 3/4	023-669	3/8 x 1	023-679		
OVAL PHILLIPS SMALL TAPPING SCREWS					
Size	Handy-Pak No.	Size	Handy-Pak No.	Size	Handy-Pak No.
8 x 1/2	023-685	8 x 3/4	023-687	8 x 1	023-689
OVAL PHILLIPS REGULAR TAPPING SCREWS					
Size	Handy-Pak No.	Size	Handy-Pak No.	Size	Handy-Pak No.
6 x 3/4	023-637				
COTTER PINS					
Size	Handy-Pak No.	Size	Handy-Pak No.	Size	Handy-Pak No.
1/16 x 3/4	023-702	3-32 x 3/4	023-708	1/8 x 1	023-715
1/16 x 1	023-703	3-32 x 1	023-709	1/8 x 1-1/2	023-717
1/16 x 1-1/2	023-705	3-32 x 1-1/2	023-711	1/8 x 2	023-718

MASTER ASSORTMENTS (Includes 2 Stax-Six Cabinets)

New Stock No.	Description	New Stock No.	Description	New Stock No.	Description
020-614	Woodruff Keys	020-635	Drain Plugs	020-643	Speed Nuts
020-626	'O' Rings	020-637	Utility Springs	020-658	Wheel Parts
020-627	Snap Rings	020-640	Frost Plugs (Cup)	020-725	Metric Bolts & Nuts
020-633	Frost Plugs	020-642	Spring Pins	020-726	Metric Bolts & Nuts

Note: Fastener Centre Conversion Kit No. 022-076 :
Includes two empty Stax-Six cabinets, Shelf and Bolt Gauge - for converting existing 022-067 Merchandiser.



Papco 'HANDY-PAK' MERCHANDISERS PRESENTOIRS 'HANDY-PAK'

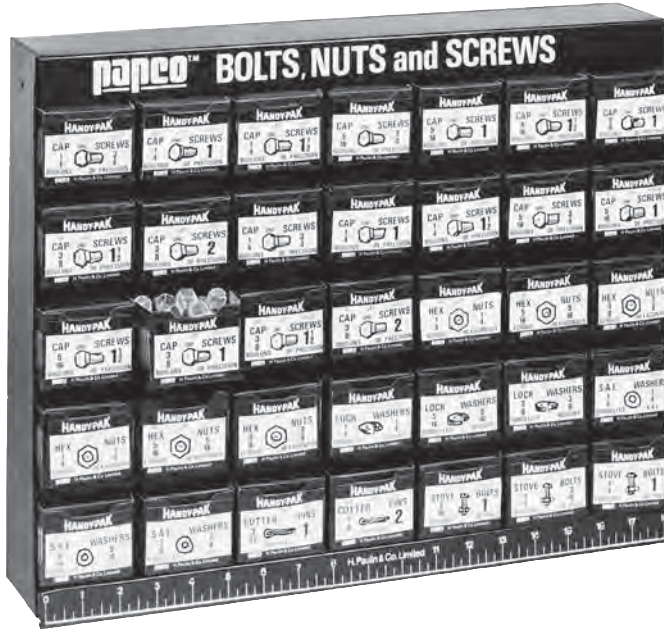

- Sturdy, Heavy Gauge, Reinforced Steel
- Use on Work Bench or Hang on Wall
- Colourful - Durable - Efficient
- Retail Prices on each Pak - Fastener Fact Chart
- Handy Bolt measuring Gauge Included.
- Inventory Control Strips

18-1/2" wide and 14-3/4" high

Note: Empty metal Merchandiser Rack No. 022-070 available to make up your own Merchandiser of any 35 'Papco' Handy-Paks.

PLATED FASTENERS MERCHANDISER No. 022-061											
Part No.		Size	Part No.		Size	Part No.		Size	Part No.		Size
Plated Grade 5 Cap Screws			Hex Nuts			Lock Washers		Cotter Pins			
UNC	UNF		UNC	UNF							
023-003	023-103	1/4 x 3/4	023-201	023-221	1/4	023-343	1/4	023-709	3/32 x 1		
023-005	023-105	1/4 x 1	023-202	023-222	5/16	023-344	5/16	023-718	1/8 x 2		
023-007	023-107	1/4 x 1-1/2	023-203	023-223	3/8	023-345	3/8	Stove Bolts			
023-016	023-116	5/16 x 3/4				S.A.E. Washers		023-503	3/16 x 1		
023-020	023-120	5/16 x 1-1/2				023-323	1/4	023-511	1/4 x 3/4		
023-031	023-131	3/8 x 1				023-324	5/16	023-512	1/4 x 1		
023-033	023-133	3/8 x 1-1/2				023-325	3/8				
023-035	023-135	3/8 x 2									

PLATED BODYSHOP FASTENERS MERCHANDISER No. 022-063											
Part No.		Size	Part No.		Size	Part No.		Size	Part No.		Size
Tapping Screws Pan Head			Tapping Screws Oval Head			Tapping Screws Oval Phillips Head		Machine Screws Round Head		Hex Nuts	
023-604	6 x 3/8	023-635	6 x 1/2	023-696	6 x 3/4	023-412	8-32 x 1	023-460	6-32		
023-605	6 x 1/2	023-644	8 x 3/4	023-687	8 x 3/4	023-419	10-32 x 1	023-461	8-32		
023-612	8 x 1/2	023-649	10 x 3/4	023-692	8 x 1-1/2	Machine Screws Oval Head		023-462	10-32		
023-614	8 x 3/4	Tapping Screws Hex Head		Machine Screws Round Head		023-433	6-32 x 1/2	Fender Washers			
023-618	10 x 1/2	023-665	8 x 1/2	023-403	6-32 x 1/2	023-440	8-32 x 1/2	023-395	1/4		
023-619	10 x 3/4	023-668	10 x 5/8	023-405	6-32 x 1	023-442	8-32 x 1	023-396	5/16		
023-621	10 x 1	023-673	14 x 3/4	023-410	8-32 x 1/2	023-449	10-32 x 1	023-397	5/16L		
023-629	14 x 1	023-675	14 x 1								
		023-677	5/16 x 1								

PLATED CAP SCREWS and NUT MERCHANDISER No. 022-064										
Part No.		Size	Part No.		Size	Part No.		Size		
Plated Grade 5 Cap Screws			Plated Grade 5 Cap Screws			Hex Nuts				
UNC	UNF		UNC	UNF		UNC	UNF			
023-003	023-103	1/4 x 3/4	023-035	023-135	3/8 x 2	023-201	023-221	1/4		
023-005	023-105	1/4 x 1	023-044	023-144	7/16 x 1-1/2	023-202	023-222	5/16		
023-007	023-107	1/4 x 1-1/2	023-055	023-155	1/2 x 1-1/2	023-203	023-223	3/8		
023-016	023-116	5/16 x 3/4	023-057	023-157	1/2 x 2	023-204	023-224	7/16		
023-018	023-118	5/16 x 1	023-059	023-159	1/2 x 2-1/2	023-205	023-225	1/2		
023-020	023-120	5/16 x 1-1/2								
023-031	023-131	3/8 x 1								
023-033	023-133	3/8 x 1-1/2								

For complete listing of 'METRIC' Handy-Pak's see pages 22 to 23.



023
Series

papco HANDY-PAKS



"Papco" Handy-Paks contain Grade 5 Medium Carbon Heat Treated Cap Screws. The higher strength and toughness of these fasteners is needed in vehicle repair work. All Handy-Paks are Bright Plated for improved rust resistance and longer life.

Order By Stock Number

GRADE 5			HEXAGON HEAD CAP SCREWS			DOUBLE HEAT TREATED		
SIZE	Coarse Thread	Fine Thread	SIZE	Coarse Thread	Fine Thread	SIZE	Coarse Thread	Fine Thread
1/4 x 1/2	023-001	023-101	5/16 x 2	023-022	023-122	7/16 x 1-3/4	023-045	023-145
1/4 x 3/4	023-003	023-103	5/16 x 2-1/2	023-024	023-124	7/16 x 2	023-046	023-146
1/4 x 1	023-005	023-105	5/16 x 3	023-025	023-125	7/16 x 2-1/2	023-048	023-148
1/4 x 1-1/4	023-006	023-106				7/16 x 3	023-049	023-149
1/4 x 1-1/2	023-007	023-107	3/8 x 3/4	023-029	023-129			
1/4 x 1-3/4	023-008	023-108	3/8 x 1	023-031	023-131	1/2 x 1	023-053	023-153
1/4 x 2	023-009	023-109	3/8 x 1-1/4	023-032	023-132	1/2 x 1-1/4	023-054	023-154
1/4 x 2-1/2	023-011	023-111	3/8 x 1-1/2	023-033	023-133	1/2 x 1-1/2	023-055	023-155
1/4 x 3	023-012	023-112	3/8 x 1-3/4	023-034	023-134	1/2 x 1-3/4	023-056	023-156
			3/8 x 2	023-035	023-135	1/2 x 2	023-057	023-157
5/16 x 1/2	023-014	023-114	3/8 x 2-1/2	023-037	023-137	1/2 x 2-1/2	023-059	023-159
5/16 x 3/4	023-016	023-116	3/8 x 3	023-038	023-138	1/2 x 3	023-160	023-160
5/16 x 1	023-018	023-118						
5/16 x 1-1/4	023-019	023-119	7/16 x 1	023-042	023-142	5/8 x 1-1/2	023-074	023-174
5/16 x 1-1/2	023-020	023-120	7/16 x 1-1/4	023-043	023-143	5/8 x 2	023-076	023-176
5/16 x 1-3/4	023-021	023-121	7/16 x 1-1/2	023-044	023-144	5/8 x 2-1/2	023-078	023-178
HEXAGON NUTS			POZI-LOK' STOP			WING NUTS		
FINISHED			UNC Coarse Thread					
SIZE	Coarse Thread	Fine Thread	SIZE	Coarse Thread	Fine Thread	SIZE	HANDY-PAK NO.	
1/4	023-201	023-221	1/4	023-204	023-224	1/4-20	023-264	
5/16	023-202	023-222	5/16	023-205	023-225	5/16-18	023-265	
3/8	023-203	023-223	3/8	023-206	023-226	3/8-16	023-266	
7/16	023-204	023-224	7/16	023-207	023-227			
1/2	023-205	023-225	1/2	023-208	023-228			
9/16	023-206	023-226						
5/8	023-207	023-227						
3/4	023-208	023-228						
PLAIN STEEL WASHERS								
SIZE	HANDY-PAK NO.		SIZE	HANDY-PAK NO.		SIZE	HANDY-PAK NO.	
3/16	023-302		3/8	023-305		9/16	023-308	
1/4	023-303		7/16	023-306		5/8	023-309	
5/16	023-304		1/2	023-307		3/4	023-310	
S A E WASHERS								
3/16	023-322		3/8	023-325		9/16	023-328	
1/4	023-323		7/16	023-326		5/8	023-329	
5/16	023-324		1/2	023-327		3/4	023-330	
SPRING LOCK WASHERS								
3/16	023-342		3/8	023-345		9/16	023-348	
1/4	023-343		7/16	023-346		5/8	023-349	
5/16	023-344		1/2	023-347		3/4	023-350	
COUNTERSUNK FINISHING WASHERS								
# 6	023-381		# 8	023-385		1/4	023-389	
# 8	023-383							
FENDER WASHERS								
1/4 x 1-1/4 O.D.	023-395		# 8	023-397		1/4	023-398	
# 8	023-396							

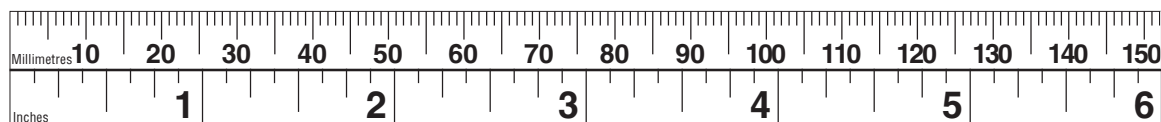



023
Series

papeo HANDY-PAKS (cont'd)



ROUND HEAD —			MACHINE SCREWS AND NUTS			— OVAL HEAD		
SIZE	ROUND	OVAL	SIZE	ROUND	OVAL	SIZE	ROUND	OVAL
6-32 x 1/2	023-403	023-433	8-32 x 1	023-412	023-442	1/4-20 x 3/4	023-424	
6-32 x 3/4	023-404		8-32 x 1-1/2	023-414	023-444	1/4-20 x 1	023-425	023-455
6-32 x 1	023-405	023-435	10-32 x 1/2	023-417	023-447	HEXAGON NUTS		
6-32 x 1-1/4	023-406		10-32 x 3/4	023-418	023-448	HANDY-PAK NO.		
6-32 x 1-1/2	023-407		10-32 x 1	023-419	023-449	6-32	023-460	
8-32 x 3/8	023-409	023-439	10-32 x 1-1/4	023-420		8-32	023-461	
8-32 x 1/2	023-410	023-440	10-32 x 1-1/2	023-421	023-451	10-32	023-462	
8-32 x 3/4	023-411	023-441				1/4-20	023-464	
ROUND HEAD STOVE BOLTS								
SIZE	HANDY-PAK NO.		SIZE	HANDY-PAK NO.		SIZE	HANDY-PAK NO.	
3/16 x 1/2	023-501		3/16 x 1-1/2	023-505		1/4 x 1	023-512	
3/16 x 3/4	023-502		3/16 x 2	023-507		1/4 x 1-1/4	023-513	
3/16 x 1	023-503		1/4 x 1/2	023-510		1/4 x 1-1/2	023-514	
3/16 x 1-1/4	023-504		1/4 x 3/4	023-511		1/4 x 2	023-516	
SHEET METAL SCREWS								
PAN HEAD			OVAL HEAD			HEX HEAD		
SIZE	PAN	OVAL	SIZE	PAN	OVAL	SIZE	HEX	
4 x 1/2	023-602		8 x 1	023-616	023-646	8 x 1/2	023-665	
6 x 3/8	023-604		10 x 1/2	023-618	023-648	10 x 1/2	023-667	
6 x 1/2	023-605	023-635	10 x 3/4	023-619	023-649	10 x 5/8	023-668	
6 x 3/4	023-607	023-637	10 x 1	023-621	023-651	10 x 3/4	023-669	
6 x 1	023-609	023-639	10 x 1-1/4	023-622	023-652	14 x 1/2	023-671	
8 x 3/8	023-611		14 x 3/4	023-628	023-658	14 x 3/4	023-673	
8 x 1/2	023-612	023-642	14 x 1	023-629	023-659	14 x 1	023-675	
8 x 3/4	023-614	023-644				5/16 x 1	023-677	
						3/8 x 1	023-679	
SIZE	OVAL PHILLIPS SMALL		SIZE	OVAL PHILLIPS SMALL		SIZE	OVAL PHILLIPS REGULAR	
8 x 1/2	023-685		8 x 1-1/2	023-692		6 x 3/4	023-696	
8 x 3/4	023-687		10 x 1	023-694		8 x 3/4	023-698	
8 x 1	023-689							
COTTER PINS								
SIZE	HANDY-PAK NO.		SIZE	HANDY-PAK NO.		SIZE	HANDY-PAK NO.	
1/16 x 3/4	023-702		3/32 x 1	023-709		1/8 x 1-1/2	023-717	
1/16 x 1	023-703		3/32 x 1-1/4	023-710		1/8 x 2	023-718	
1/16 x 1-1/2	023-705		3/32 x 1-1/2	023-711		5/32 x 1-1/2	023-722	
3/32 x 1/2	023-707		1/8 x 1	023-715		5/32 x 2	023-723	
3/32 x 3/4	023-708		1/8 x 1-1/4	023-716				

Note: Handy-Pak contents are based on Dealer Prices currently in effect and are subject to change.

INVERTED DRAWER BOX

- Upside-down Design Converts to Double Strength Drawer.
- Drawer Pull for Easy Access.
- Heavy Weight Fibreboard.



Convenient SIX-PAK trays.

025 Series

MEGAPAK™



More pieces per pack than Handy-Paks!

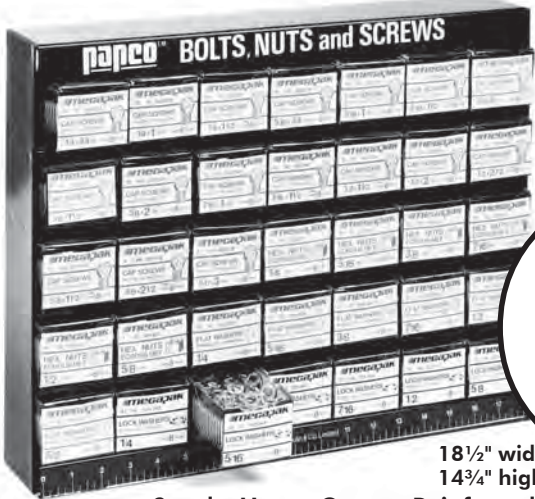

18 1/2" wide
14 3/4" high

- Sturdy, Heavy Gauge, Reinforced Steel Cabinet
- Use on Work Bench or Hang on Wall
- Colourful-Durable-Efficient
- Includes handy Bolt measuring Gauge

'Papco' Mega-Paks™ are uniformly priced packages of the most popular High Strength Grade 8 Fasteners in both UNC Coarse and UNF Fine Thread, Stainless Steel, Marine Fasteners plus Wheel Bolts and Nuts. Each Mega-Pak™ features a larger quantity than standard Handy-Paks™, illustrated colour-coded

labels and a double strength drawer box conveniently packed in Six-Pak trays.

'Papco' Mega-Paks™ are available individually or in factory prepared Merchandisers containing 35 sizes of the fastest moving sizes of High Strength Grade 8 Fasteners, Marine Fasteners and Wheel Parts.

UNF PLATED GRADE 8 FASTENER MERCHANDISER No. 022-059					
Part No.	Size	Part No.	Size	Part No.	Size
UNF Plated Gr. 8 Cap Screws		UNF Plated Gr. 8 Cap Screws		UNF Grade 8 Hex Nuts	
025-103	1/4-28x3/4	025-142	7/16-20x1	025-221	1/4-28
025-105	1/4-28x1	025-144	7/16-20x1 1/2	025-222	5/16-24
025-107	1/4-28x1 1/2	025-155	1/2-20x1 1/2	025-223	3/8-24
025-116	5/16-24x3/4	025-157	1/2-20x2	025-224	7/16-20
025-118	5/16-24x1	025-159	1/2-20x2 1/2	025-225	1/2-20
025-120	5/16-24x1 1/2	025-174	5/8-18x1 1/2	025-227	5/8-18
025-131	3/8-24x1	025-176	5/8-18x2		
025-133	3/8-24x1 1/2	025-178	5/8-18x2 1/2		
025-135	3/8-24x2				
GRADE 8 Tension Washers		GRADE 8 Lock Washers			
025-303	1/4	025-343	1/4		
025-304	5/16	025-344	5/16		
025-305	3/8	025-345	3/8		
025-306	7/16	025-346	7/16		
025-307	1/2	025-347	1/2		
025-309	5/8	025-349	5/8		

UNC PLATED GRADE 8 FASTENER MERCHANDISER No. 022-060					
Part No.	Size	Part No.	Size	Part No.	Size
UNC Plated Gr. 8 Cap Screws		UNC Plated Gr. 8 Cap Screws		UNC Grade 8 Hex Nuts	
025-003	1/4-20x3/4	025-042	7/16-14x1	025-201	1/4-20
025-005	1/4-20x1	025-044	7/16-14x1 1/2	025-202	5/16-18
025-007	1/4-20x1 1/2	025-055	1/2-13x1 1/2	025-203	3/8-16
025-016	5/16-18x3/4	025-057	1/2-13x2	025-204	7/16-14
025-018	5/16-18x1	025-059	1/2-13x2 1/2	025-205	1/2-13
025-020	5/16-18x1 1/2	025-074	5/8-11x1 1/2	025-207	5/8-11
025-031	3/8-16x1	025-076	5/8-11x2		
025-033	3/8-16x1 1/2	025-078	5/8-11x2 1/2		
025-035	3/8-16x2				
GRADE 8 Tension Washers		GRADE 8 Lock Washers			
025-303	1/4	025-343	1/4		
025-304	5/16	025-344	5/16		
025-305	3/8	025-345	3/8		
025-306	7/16	025-346	7/16		
025-307	1/2	025-347	1/2		
025-309	5/8	025-349	5/8		

UNC 18.8 STAINLESS STEEL BOLT AND NUT MERCHANDISER No. 022-057					
Part No.	Size	Part No.	Size	Part No.	Size
UNC 18.8 St. Steel Cap Screws		UNC 18.8 St. Steel Cap Screws		UNC 18.8 St. Steel Cap Screws	
025-401	1/4x1/2	025-418	5/16x1	025-437	3/8x2 1/2
025-403	1/4x3/4	025-420	5/16x1 1/2	025-438	3/8x3
025-405	1/4x1	025-422	5/16x2	025-439	3/8x3 1/2
025-407	1/4x1 1/2	025-424	5/16x2 1/2		
025-409	1/4x2	025-429	3/8x3/4	UNC 18.8 St. Steel Hex Nuts	
025-411	1/4x2 1/2	025-431	3/8x1	025-501	1/4
025-414	5/16x1/2	025-433	3/8x1 1/2	025-502	5/16
025-416	5/16x3/4	025-435	3/8x2	025-503	3/8
UNC 18.8 Stainless Steel Pozi-Lok Nuts		18.8 Stainless Steel Flat Washers		18.8 Stainless Steel Fender Washers	
025-511	1/4	025-521	1/4	025-531	1/4
025-512	5/16	025-522	5/16	025-532	5/16
025-513	3/8	025-523	3/8	025-533	3/8
18.8 Stainless Steel Cotter Pins		18.8 Stainless Steel Finishing Washers			
025-541	3/32x1 1/2	025-706	No. 6		
025-542	3/32x2	025-708	No. 8		
025-548	1/8x2	025-709	No. 10		
025-551	1/8x3	025-710	1/4		

18.8 STAINLESS STEEL SCREW MERCHANDISER No. 022-058					
Part No.	Size	Part No.	Size	Part No.	Size
18.8 Stainless Steel Round Slot Machine Screws		18.8 Stainless Steel Oval Phillips Machine Screws		18.8 Stainless Steel Flat Socket Tapping Screws	
025-613	10-24x1	025-620	10-24x1	025-651	6x3/4
025-614	10-24x1 1/2	025-621	10-24x1 1/4	025-652	6x1
025-615	10-24x2	025-622	10-24x1 1/2	025-653	8x3/4
025-616	1/4x1	025-623	1/4x1	025-654	8x1
025-617	1/4x1 1/2	025-624	1/4x1 1/2	025-655	8x1 1/4
025-618	1/4x2	025-625	1/4x2	025-656	8x1 1/2
025-619	1/4x2 1/2			025-657	10x11/4
18.8 Stainless Steel Flat Socket Tapping Screws		18.8 Stainless Steel Pan Socket Tapping Screws		18.8 Stainless Steel Hex Machine Screw Nuts	
025-660	12x1 1/2	025-661	12x2	025-700	10-24
025-662	12x2 1/2			025-701	1/4
18.8 Stainless Steel Finishing Washers					
025-674	8x1	025-706	No. 6		
025-676	8x1 1/2	025-708	No. 8		
025-678	10x11/2	025-709	No. 10		
025-679	10x2	025-710	1/4		

For Wheel Parts Mega-Pak™ Merchandiser No. 022-056 see Wheel Parts page 154 or current Wheel parts catalogue.



Metric HANDY-PAKS



71" h. x 36-1/4" w. x 12" d. incl. sign



18 1/2" wide
14 3/4" high

UNIFORM PRICED PACKAGES OF METRIC FASTENERS

- All Bright Plated Material
- No Broken Boxes
- Good For Regular Stock
- Ideal For Assortment Refills
- Best Value
- Fully Illustrated, Colour-Coded Labels
- Five Shelf Empty Storage Area with Doors

'Papco' Handy-Paks are the most economical method of stocking Metric Fasteners. They contain the complete range of ISO Coarse, Fine and Extra Fine Cap Screws, Nuts and Washers. The available merchandiser is designed to provide maximum coverage for a minimum investment.



MASTER METRIC HANDY-PAK MERCHANDISER No. 022-068

Contains 273 Handy-Paks, 91 sizes of ISO Coarse, Fine and Extra Fine Cap Screws, Nuts and Washers plus rack, measuring gauge and sign.

- Sturdy, Heavy Gauge, Reinforced Steel Cabinet
- Use on Work Bench or Hang on Wall
- Colourful - Durable - Efficient
- Includes Handy Bolt Measuring Gauge and Inventory Control Strips

METRIC FINE THREAD MERCHANDISER No. 022-062

35 sizes of Metric Fine and Extra Fine Cap Screws, Nuts and Lock Washers.

METRIC ISO COARSE THREAD MERCHANDISER No. 022-065

35 best sizes of Metric Coarse Thread Cap Screws, Nuts and Washers.

PLATED METRIC FASTENERS MERCHANDISER No. 022-066

35 sizes of Metric Machine Screws, Lock Washers and Nuts, Spring Washers, Cotter Pins and Socket Screws. (see reverse side for contents)



MERCHANDISER NO. 022-062 Contents							
Part No.	Size	Part No.	Size	Part No.	Size	Part No.	Size
Fine Metric Cap Screws		Fine Metric Cap Screws		Extra Fine Metric Cap Screws		Extra Fine Metric Nuts	
024-120	M8X20	024-138	M10X60	024-174	M10X40	024-270	M10X1.00
024-122	M8X30	024-144	M12X30	024-176	M10X50	024-272	M12X1.25
024-124	M8X40	024-146	M12X40	024-184	M12X30	Metric Lock Washers	
024-126	M8X50	024-148	M12X50	024-186	M12X40	024-324	4mm
024-130	M10X20	Extra Fine Metric Cap Screws		024-188	M12X50	024-325	5mm
024-131	M10X25	Extra Fine Metric Cap Screws		Fine Metric Hex Nuts		024-326	6mm
024-132	M10X30	024-170	M10X20	024-258	M8X1.00	024-328	8mm
024-134	M10X40	024-171	M10X25	024-260	M10X1.25	024-330	10mm
024-136	M10X50	024-172	M10X30	024-262	M12X1.5	024-332	12mm

MERCHANDISER NO. 022-065 Contents							
Part No.	Size	Part No.	Size	Part No.	Size	Part No.	Size
ISO Coarse Metric Cap Screws		ISO Coarse Metric Cap Screws		ISO Coarse Metric Cap Screws		Coarse Hex Nuts	
024-002	M4X16	024-045	M8X12	024-064	M10X40	024-204	M4
024-013	M5X16	024-046	M8X16	024-066	M10X50	024-205	M5
024-014	M5X20	024-047	M8X20	024-068	M10X60	024-206	M6
024-015	M5X25	024-048	M8X25	024-070	M10X70	024-208	M8
024-023	M6X12	024-049	M8X30	Metric Flat Washers		024-210	M10
024-024	M6X16	024-051	M8X40	024-304	4mm	024-212	M12
024-025	M6X20	024-053	M8X50	024-305	5mm		
024-026	M6X25	024-055	M8X60	024-306	6mm		
024-027	M6X30	024-057	M8X70	024-308	8mm		
024-030	M6X45	024-062	M10X30	024-310	10mm		

PLATED METRIC FASTENERS MERCHANDISER No. 022-066									
Part No.	Size	Part No.	Size	Part No.	Size	Part No.	Size	Part No.	Size
Metric Machine Screws		Metric Locknuts		Metric Lock Washers		Metric Spring Washers		Metric Cotter Pins	
024-406	M4X6	024-224	M4	024-324	4mm	024-344	4mm	024-704	1.5X16
024-412	M4X12	024-225	M5	024-325	5mm	024-345	5mm	024-707	2X20
024-420	M5X10	024-226	M6	024-326	6mm	024-346	6mm	024-713	3X40
024-426	M5X16	024-228	M8	024-328	8mm	024-348	8mm	024-716	4X50
024-436	M6X16	024-230	M10	024-330	10mm	024-350	10mm	024-919	M6X12
024-440	M6X20							024-930	M8X12
								024-734	2X16
								024-740	3X24
								024-749	4X36
								024-758	5X50
								024-764	6X50

MERCHANDISER NO. 022-068 Contents							
Part No.	Size	Part No.	Size	Part No.	Size	Part No.	Size
ISO Coarse Metric Cap Screws		ISO Coarse Metric Cap Screws		Fine Metric Cap Screws		Extra Fine Metric Hex Nuts	
024-002	M4X16	024-060	M10X20	024-144	M12X30	024-270	M10X1.00
024-004	M4X25	024-061	M10X25	024-146	M12X40	024-272	M12X1.25
024-012	M5X12	024-062	M10X30	024-148	M12X50	Metric Flat Washers	
024-013	M5X16	024-063	M10X35	Extra Fine Metric Cap Screws		024-304	4mm
024-014	M5X20	024-064	M10X40	024-170	M10X20	024-305	5mm
024-015	M5X25	024-066	M10X50	024-171	M10X25	024-306	6mm
024-023	M6X12	024-068	M10X60	024-172	M10X30	024-308	8mm
024-024	M6X16	024-070	M10X70	024-174	M10X40	024-310	10mm
024-025	M6X20	024-075	M12X30	024-176	M10X50	024-312	12mm
024-026	M6X25	024-077	M12X40	024-176	M10X50	Metric Lock Washers	
024-027	M6X30	024-079	M12X50	024-184	M12X30	024-324	4mm
024-028	M6X35	024-081	M12X60	024-186	M12X40	024-325	5mm
024-029	M6X40	024-083	M12X70	024-188	M12X50	024-326	6mm
024-030	M6X45	Fine Metric Cap Screws		ISO Coarse Metric Hex Nuts		024-328	8mm
024-031	M6X50	024-120	M8X20	024-204	M4	024-330	10mm
024-045	M8X12	024-122	M8X30	024-205	M5	024-332	12mm
024-046	M8X16	024-124	M8X40	024-206	M6	Metric Lock Nuts	
024-047	M8X20	024-126	M8X50	024-208	M8	024-224	M4
024-048	M8X25	024-130	M10X20	024-210	M10	024-226	M6
024-049	M8X30	024-131	M10X25	024-212	M12	024-228	M8
024-050	M8X35	024-132	M10X30	Fine Metric Hex Nuts		024-230	M10
024-051	M8X40	024-133	M10X35	024-258	M8X1.00	Metric Machine Screws	
024-052	M8X45	024-134	M10X40	024-260	M10X1.25	024-430	M6X10
024-053	M8X50	024-136	M10X50	024-262	M12X1.5	024-436	M6X16
024-055	M8X60	024-138	M10X60			024-440	M6X20
024-057	M8X70						

Note: Metric Handy-Pak contents are based on Dealer prices currently in effect and are subject to change.



024
Series

papeco METRIC HANDY-PAKS

CLASS 8.8		HEXAGON HEAD CAP SCREWS		Regular ISO Coarse Thread Series	
Size	Handy-Pak No.	Size	Handy-Pak No.	Size	Handy-Pak No.
M4x16*	024-002	M8x12*	024-045	M10x35*	024-063
M4x25	024-004	M8x16*	024-046	M10x40	024-064
M5x12*	024-012	M8x20*	024-047	M10x50	024-066
M5x16*	024-013	M8x25*	024-048	M10x60	024-068
M5x20*	024-014	M8x30*	024-049	M10x70	024-070
M5x25*	024-015	M8x35	024-050		
M6x12*	024-023	M8x40	024-051	M12x30*	024-075
M6x16*	024-024	M8x45	024-052	M12x40*	024-077
M6x20*	024-025	M8x50	024-053	M12x50	024-079
M6x25*	024-026	M8x60	024-055	M12x60	024-081
M6x30	024-027	M8x70	024-057	M12x70	024-083
M6x35	024-028				
M6x40	024-029	M10x20*	024-060	<i>Thread Length: Formula is 2D + 6mm. Items marked * are Fully Threaded.</i>	
M6x45	024-030	M10x25*	024-061		
M6x50	024-031	M10x30*	024-062		
CLASS 8		HEXAGON NUTS		Regular ISO Coarse Thread Series	
M4	024-204	M6	024-206	M10	024-210
M5	024-205	M8	024-208	M12	024-212
CLASS 8.8		FINE THREAD HEXAGON HEAD CAP SCREWS			
M8x1.0x20*	024-120	M10x1.25x25*	024-131	M10x1.25x60	024-138
M8x1.0x30*	024-122	M10x1.25x30*	024-132	M12x1.5x30*	024-144
M8x1.0x40*	024-124	M10x1.25x35*	024-133	M12x1.5x40*	024-146
M8x1.0x50*	024-126	M10x1.25x40*	024-134	M12x1.5x50*	024-148
M10x1.25x20*	024-130	M10x1.25x50*	024-136		
CLASS 8.8		EXTRA FINE THREAD HEXAGON HEAD CAP SCREWS			
M10x1.0x20*	024-170	M10x1.0x40*	024-174	M12x1.25x40*	024-186
M10x1.0x25*	024-171	M10x1.0x50*	024-176	M12x1.25x50*	024-188
M10x1.0x30*	024-172	M12x1.25x30*	024-184		
CLASS 8		FINE and EXTRA FINE THREAD HEXAGON NUTS			
M8x1.0	024-258	M12x1.5	024-262	M10x1.0	024-270
M10x1.25	024-260			M12x1.25	024-272
NYLON COLLAR STOP NUTS		‘POZI-LOK’ NUTS		Regular ISO Coarse Thread Series	
M4	024-224	M6	024-226	M10	024-230
M5	024-225	M8	024-228		
FLAT WASHERS					
4mm	024-304	6mm	024-306	10mm	024-310
5mm	024-305	8mm	024-308	12mm	024-312
LOCK WASHERS					
4mm	024-324	6mm	024-326	10mm	024-330
5mm	024-325	8mm	024-328	12mm	024-332
SPRING (wave type) WASHERS (PLAIN FINISH)					
4mm	024-344	6mm	024-346	10mm	024-350
5mm	024-345	8mm	024-348		
MACHINE SCREWS Pan Slot Head					
M4x6	024-406	M5x10	024-420	M6x10	024-430
M4x12	024-412	M5x16	024-426	M6x16	024-436
				M6x20	024-440
COTTER PINS					
M1.5x16	024-704	M3x25	024-710	M4x50	024-716
M2.0x20	024-707	M3x40	024-713		
SLOTTED SPRING PINS (PLAIN FINISH)					
M2.0x16	024-734	M4x18	024-746	M5x50	024-758
M2.5x18	024-737	M4x36	024-749	M6x22	024-761
M3.0x24	024-740	M4x50	024-752	M6x50	024-764
M3.0x40	024-743	M5x36	024-755		
SOCKET SET SCREWS with keys				ALLOY STEEL	
M4x5	024-904	M6x8	024-916	M8x8	024-926
M4x10	024-907	M6x12	024-919	M8x12	024-930
M5x10	024-910	M6x20	024-922	M8x20	024-934
M5x16	024-913				
SOCKET SCREW KEYS				(PLAIN FINISH)	
1.5mm	024-980	3mm	024-983	6mm	024-986
2.0mm	024-981	4mm	024-984	8mm	024-988
2.5mm	024-982	5mm	024-985		

608's
Series



METRIC HEX HEAD CAP SCREWS
BOULONS DE PRECISION METRIQUE



High Tensile Screws made to ISO-Metric Specifications.
Property Class: 8.8 (nominal tensile strength 800 MPa or about 118,000 p.s.i., similar to SAE Grade 5)

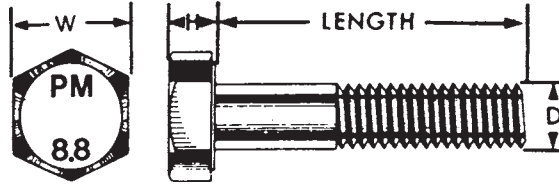

Heat Treated Steel

ZINC CHROMATE PLATED
REGULAR ISO COARSE THREAD SERIES

Dia.(D)	M4	M5	M6	M7	M8	M10	M12	M14	M16	M18	M20	M24
Inch Size	.157"	.197"	.236"	.276"	.315"	.394"	.472"	.551"	.630"	.709"	.787"	.944"
A.F. (W)	7	8	10	11	13	17	19	22	24	27	30	36
Hght. (H)	2.8	3.5	4.0	5.5	5.5	7.0	8.0	9.0	10.0	12.0	13.0	15.0
Pitch(mm)	.70	.80	1.00	1.00	1.25	1.50	1.75	2.00	2.00	2.50	2.50	3.00
Length												
12 mm	-	608-198*	608-267*	-	608-311*	-	-	-	-	-	-	-
16 mm	608-139*	608-201*	608-270*	-	608-314*	608-364*	-	-	-	-	-	-
20 mm	608-141*	608-203*	608-272*	-	608-316*	608-366*	-	-	-	-	-	-
25 mm	608-143*	608-205*	608-274*	-	608-318*	608-368*	608-412*	608-436*	608-462*	-	-	-
30 mm	-	-	608-276	-	608-320*	608-370*	608-414*	608-438*	608-464*	-	-	-
35 mm	-	-	608-277	-	608-321	608-371*	608-415*	-	608-465*	-	-	-
40 mm	-	-	608-278	-	608-322	608-372	608-416*	608-440*	608-466*	608-500*	608-520*	-
45 mm	-	-	608-279	-	608-323	608-373	608-417	-	608-467	-	-	-
50 mm	-	-	608-280	-	608-324	608-374	608-418	608-442	608-468	608-502*	608-522*	608-552*
60 mm	-	-	-	-	608-326	608-376	608-420	608-444	608-470	608-504	608-524*	608-554*
70 mm	-	-	-	-	608-328	608-378	608-422	608-446	608-472	608-506	608-526	608-556*
80 mm	-	-	-	-	608-330	608-380	608-424	608-448	608-474	608-508	608-528	608-558
90 mm	-	-	-	-	-	-	608-425	608-449	608-475	608-509	608-529	608-559
100 mm	-	-	-	-	-	-	608-426	608-450	608-476	608-510	608-530	608-560
110 mm	-	-	-	-	-	-	608-427	608-451	608-477	608-511	608-531	608-561
120 mm	-	-	-	-	-	-	608-428	608-452	608-478	608-512	608-532	608-562
130 mm	-	-	-	-	-	-	608-429	-	608-479	608-513	608-533	608-563
140 mm	-	-	-	-	-	-	608-430	-	608-480	608-514	608-534	608-564
150 mm	-	-	-	-	-	-	608-431	-	608-481	608-515	608-535	608-565
160 mm	-	-	-	-	-	-	608-432	-	608-482	-	608-536	608-5667
170 mm	-	-	-	-	-	-	608-433	-	-	-	608-537	-
180 mm	-	-	-	-	-	-	608-434	-	-	-	608-538	608-5687
200 mm	-	-	-	-	-	-	608-435	-	-	-	608-539	-

Standard Packages: M4 to M10 - 100pcs, M12 - 50 pcs, M14 to M24x80 -25pcs, M24x90 to 180mm - 10 pcs.

* - Indicates items fully threaded. Thread Length Formula is 2d+6mm.

609
Series



METRIC HEX HEAD CAP SCREWS
FINE and EXTRA FINE THREAD

High Tensile Screws made to ISO-Metric Specifications.

Property Class: 8.8 (nominal tensile strength 800 MPa or about 118,000 p.s.i.)

610
Series

Heat Treated Steel **RED (Fine Thread) GREEN (Extra Fine Thread) DICHROMATE PLATED**

Dia. x Pitch	M8 x 1.0	M10 x 1.25	M12 x 1.5	M14 x 1.5	M16 x 1.5	M18 x 1.5	M20 x 1.5	M10 x 1.0	M12 x 1.25
Length	Fine Thread	Fine Thread	Fine Thread	Fine Thread	Fine Thread	Fine Thread	Fine Thread	X-Fine Thread	X-Fine Thread
20 mm	609-316*	609-366*	-	-	-	-	-	610-366*	-
25 mm	-	609-368*	-	609-436*	-	-	-	610-368*	-
30 mm	609-320*	609-370*	609-414*	609-438*	609-464*	-	-	610-370*	610-414*
40 mm	609-322*	609-372*	609-416*	609-440*	609-466*	609-500*	609-520*	610-372*	610-416*
45 mm	-	-	609-417*	609-441*	-	-	-	-	-
50 mm	609-324*	609-374*	609-418*	609-442	609-468*	609-502*	609-522*	610-374*	610-418*
55 mm	-	-	609-419	-	-	-	-	-	-
60 mm	-	609-376	609-420	609-444	609-470	609-504	609-524*	-	-
65 mm	-	-	609-421	-	-	-	-	-	-
70 mm	-	609-378	609-422	609-446	609-472	609-506	609-526	-	-
80 mm	-	609-380	609-424	609-448	609-474	609-508	609-528	-	-
90 mm	-	609-382	609-425	-	609-475	609-509	609-529	-	-
100 mm	-	609-384	609-426	-	609-476	-	609-530	-	-
110 mm	-	-	-	-	609-477	-	609-532	-	-

Standard Packages: FINE THREAD M8 to M10 x 60 -50pcs, M10x70 to M18x90 - 25 pcs, M20 - 10pcs.
EXTRA FINE THREAD - 25 pcs.

* - Indicates items fully threaded. Thread Length Formula is 2d+6mm.



Also available in plain finish:

10.9

Metric Cap Screws

612
Series

10.0

Metric Hex Nuts

671
Series

612's
Series



METRIC HEX HEAD CAP SCREWS
BOULONS DE PRECISION METRIQUE



High Tensile Screws made to ISO-Metric Specifications.

Property Class: 10.9 (nominal tensile strength 1040 MPa or about 150,000 p.s.i., similar to SAE Grade 8)

Heat Treated Steel

PLAIN FINISH
REGULAR ISO COARSE THREAD SERIES

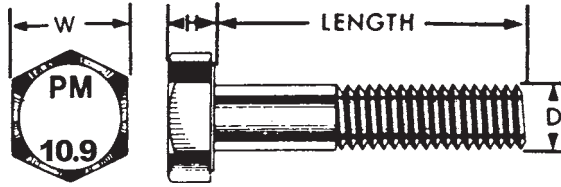

Dia.	M6	M8	M10	M12	M14	M16	M20	M24
Inch Size	.236"	.315"	.394"	.472"	.551"	.630"	.787"	.944"
A.F (W)	10	13	17	19	22	24	30	36
Height (H)	4.0	5.5	7.0	8.0	9.0	10.0	13.0	15.0
Pitch (mm)	1.00	1.25	1.50	1.75	2.00	2.00	2.50	3.00
Length								
20mm	612-272*	612-316*	612-366*	-	-	-	-	-
25mm	612-274*	612-318*	612-368*	612-412*	-	-	-	-
30mm	612-276*	612-320*	612-370*	612-414*	612-438*	-	-	-
35mm	612-277	612-321	612-371*	612-415*	-	-	-	-
40mm	612-278	612-322	612-372	612-416*	612-440*	612-466*	-	-
45mm	612-279	612-323	612-373	612-417	-	-	-	-
50mm	612-280	612-324	612-374	612-418	612-442	612-468	612-522*	612-552*
60mm	612-282	612-326	612-376	612-419	612-444	612-469	612-524*	612-554*
70mm	-	612-328	612-378	612-420	612-446	612-472	612-526	612-556*
80mm	-	-	612-380	612-422	-	612-474	612-528	612-558
90mm	-	-	-	612-424	-	612-475	612-529	612-559
100mm	-	-	-	612-425	-	612-476	612-530	612-560
110mm	-	-	-	612-426	-	-	612-531	612-561
120mm	-	-	-	612-428	-	612-478	612-532	612-562
130mm	-	-	-	-	-	-	612-533	612-563
140mm	-	-	-	-	-	-	612-534	612-564
150mm	-	-	-	-	-	-	612-535	612-565
160mm	-	-	-	-	-	-	612-536	612-566
170mm	-	-	-	-	-	-	-	612-567
180mm	-	-	-	-	-	-	-	612-568
200mm	-	-	-	-	-	-	-	612-570

Standard Packages: M6 to M10 – 100pcs, M12 – 50 pcs, M14 to M24x80 – 25pcs, M24x90 to 180mm – 10 pcs.

* - Indicates items fully threaded. Thread Length Formula is 2d+6mm.

671
Series



METRIC HEX NUTS
ECROUS HEX METRIQUE

High Tensile Nuts conform to ISO-Metric Specifications.
Property Class: 10

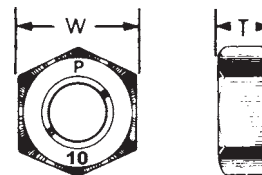

PLAIN FINISH

REGULAR ISO COARSE THREAD SERIES

Dia.	M6	M8	M10	M12	M14	M16	M18	M20	M24
A.F (W)	10	13	17	19	22	24	27	30	36
Thick. (T)	5	6.5	8	9.5	11	13	15	16	18
Pitch(mm)	1.00	1.25	1.50	1.75	2.00	2.00	2.50	2.50	3.00
Part No.	671-006	671-008	671-010	671-012	671-014	671-016	671-018	671-020	671-024
Std. Pkg.	100	100	100	50	25	25	25	25	25



670
Series

papeco METRIC HEX NUTS ECROUS HEX METRIQUE

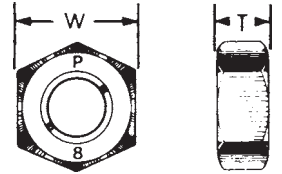

High Tensile Nuts conform to ISO-Metric Specifications.
Property Class: 8

ZINC CHROMATE PLATED

REGULAR ISO COARSE THREAD SERIES

Dia.	M3	M4	M5	M6	M7	M8	M10	M12	M14	M16	M18	M20	M24
A.F (W)	5.5	7	8	10	10	13	17	19	22	24	27	30	36
Thick. (T)	2.4	3.2	4	5	5.5	6.5	8	9.5	11	13	15	16	18
Pitch(mm)	0.5	0.7	0.8	1	1	1.25	1.5	1.75	2	2	2.5	2.5	3
Part No.	670-003	670-004	670-005	670-006	670-007	670-008	670-010	670-012	670-014	670-016	670-018	670-020	670-024
Std. Pkg.	100	100	100	100	100	100	100	50	25	25	25	25	25

papeco METRIC FINE and EXTRA FINE THREAD HEX NUTS ECROUS FILETAGE METRIQUE A PAS FIN ET EXTRA FIN

High Tensile Nuts conform to ISO-Metric Specifications. Property Class: 8

FINE THREAD
RED DICHROMATE PLATED

EXTRA FINE THREAD
GREEN DICHROMATE PLATED

Dia.	M8	M10	M12	M14	M16	M18	M20	M10	M12
Pitch (mm)	1.0	1.25	1.5	1.5	1.5	1.5	1.5	1.0	1.25
Part No.	670-208	670-210	670-212	670-214	670-216	670-218	670-220	670-750	670-765
Std. Pkg.	25	25	25	25	25	25	25	25	25

'POZI-LOK' NYLON COLLAR STOP NUTS

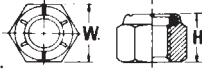

Regular ISO Coarse Thread Series

Stock No.	Size	Width A.F. (W)	Height (H)	Std. Pkg.
700-004	M4	7	5.0	100
700-005	M5	8	5.0	100
700-006	M6	10	6.0	100
700-008	M8	13	8.0	100
700-010	M10	17	10.0	100
700-012	M12	19	12.0	50
700-016	M16	24	16.0	25

'TRI-LOK' LOCK NUTS

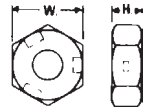

Regular ISO Coarse Thread Series

All metal for high temperature applications.

Stock No.	Size	Width A.F. (W)	Height (H)	Std. Pkg.
705-006	M6	10	5.0	100
705-008	M8	13	6.5	100
705-010	M10	17	8.0	100
705-012	M12	19	10.0	50

FLAT WASHERS

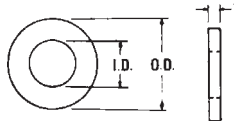

Stock No.	Bolt Size	I.D.	O.D.	(T) Thick.	Std. Pkg.
730-004	4mm	4.3	9.0	0.8	100
730-005	5mm	5.3	11.0	1.0	100
730-006	6mm	6.4	12.5	1.6	100
730-008	8mm	8.4	17.0	1.6	100
730-010	10mm	10.5	21.0	2.0	100
730-012	12mm	13.0	24.0	2.5	50
730-014	14mm	15.0	28.0	2.5	25
730-016	16mm	17.0	30.0	3.0	25
730-018	18mm	19.0	34.0	3.0	25
730-020	20mm	21.0	37.0	3.0	25
730-024	24mm	25.0	44.0	4.0	25

LOCK WASHERS

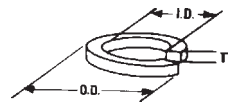

Stock No.	Bolt Size	I.D.	O.D.	(T) Thick.	Std. Pkg.
740-004	4mm	4.1	7.1	0.9	100
740-005	5mm	5.1	8.7	1.2	100
740-006	6mm	6.1	11.1	1.6	100
740-008	8mm	8.2	14.2	2.0	100
740-010	10mm	10.2	17.2	2.2	100
740-012	12mm	12.2	20.2	2.5	50
740-014	14mm	14.2	23.2	3.0	25
740-016	16mm	16.2	26.2	3.5	25
740-018	18mm	18.2	28.2	3.5	25
740-020	20mm	20.2	32.2	4.0	25
740-024	24mm	24.5	40.0	5.0	25

COTTER PINS

Standard Package 100 pieces.



Stock No.	Size	Stock No.	Size
752-006	1.5x16	752-027	3x40
752-015	2x20	752-037	4x50
752-024	3x25		

MACHINE SCREWS PAN SLOT HEAD

Standard Package 100 pieces.



Stock No.	Size	Stock No.	Size
770-132	M4x6	770-266	M6x10
770-136	M4x12	770-270	M6x16
770-197	M5x10	770-272	M6x20
770-201	M5x16		

All dimensions are in millimetres.

All Standard Metric Fasteners Zinc Plated.

For Metric Wing Nuts see page 124.

Note: For other Metric Products see index.

020-425

020-426

Includes 100 pcs. M8x1.0, M10x1.0, M10x1.25, M12x1.25 and M12x1.5 Cap Screws and Nuts. Fine Thread Series.

Includes 160 pcs. M5x20, M6x20, M6x30, M8x20, M8x30, M8x40 M10x40 and M12x40 Cap Screws and Nuts. Coarse Thread Series.



METRIC MASTER ASSORTMENTS

Most popular METRIC FASTENERS packed in durable steel merchandisers with illustrated lid labels.

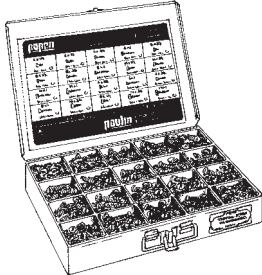

No. 020-730 METRIC CAP SCREWS AND NUTS Fine and Extra Fine Thread																																																																								
25 pcs. Extra Fine	40 pcs. Fine Thread	25 pcs. Extra Fine Hex Nuts																																																																						
M10 x 1.00 x 20mm	M8 x 1.00 x 30mm	M10 x 1.00																																																																						
M10 x 1.00 x 25mm	M8 x 1.00 x 50mm	M12 x 1.25																																																																						
M10 x 1.00 x 40mm	M10 x 1.25 x 25mm																																																																							
M10 x 1.00 x 50mm	M10 x 1.25 x 30mm	40 pcs. Fine Hex Nuts																																																																						
M12 x 1.25 x 30mm	M10 x 1.25 x 40mm	M8 x 1.00																																																																						
M12 x 1.25 x 40mm	M10 x 1.25 x 50mm	M10 x 1.25																																																																						
M12 x 1.25 x 50mm	M12 x 1.50 x 40mm	M12 x 1.50																																																																						
	M12 x 1.50 x 50mm																																																																							
<table border="1" style="width: 100%;"> <tr> <td colspan="2" style="text-align: center;">No. 020-725 METRIC CAP SCREWS and Nuts 255 Cap Screws - 255 Nuts - 60 Lock Nuts</td> <td colspan="2" style="text-align: center;">No. 020-726 METRIC CAP SCREWS and Nuts 83 Cap Screws - 83 Nuts - 20 Lock Nuts</td> <td colspan="3" style="text-align: center;">No. 020-727 METRIC FLAT WASHERS, SPRING WASHERS, LOCK WASHERS</td> </tr> <tr> <td>M4 x 16</td> <td>M6 x 30</td> <td>M8 x 12</td> <td>M10 x 30</td> <td style="text-align: center;">425 pcs. Flat Washers</td> <td style="text-align: center;">125 pcs. Spring Washers</td> <td style="text-align: center;">450 pcs. Lock Washers</td> </tr> <tr> <td>M5 x 12</td> <td>M6 x 35</td> <td>M8 x 16</td> <td>M10 x 40</td> <td>4mm</td> <td>4mm</td> <td>4mm</td> </tr> <tr> <td>M5 x 16</td> <td>M6 x 45</td> <td>M8 x 20</td> <td>M10 x 50</td> <td>5mm</td> <td>5mm</td> <td>5mm</td> </tr> <tr> <td>M5 x 20</td> <td>M4 Hex Nuts</td> <td>M8 x 25</td> <td>M10 x 60</td> <td>6mm</td> <td>6mm</td> <td>6mm</td> </tr> <tr> <td>M5 x 25</td> <td>M5</td> <td>M8 x 30</td> <td>M10 x 70</td> <td>8mm</td> <td>8mm</td> <td>8mm</td> </tr> <tr> <td>M6 x 12</td> <td>M6</td> <td>M8 x 40</td> <td>M8 Hex Nuts</td> <td>10mm</td> <td>10mm</td> <td>10mm</td> </tr> <tr> <td>M6 x 16</td> <td>M4 Locknuts</td> <td>M8 x 50</td> <td>M10</td> <td></td> <td></td> <td></td> </tr> <tr> <td>M6 x 20</td> <td>M5</td> <td>M8 x 60</td> <td>M8 Locknuts</td> <td></td> <td></td> <td></td> </tr> <tr> <td>M6 x 25</td> <td>M6</td> <td>M8 x 70</td> <td>M10</td> <td></td> <td></td> <td></td> </tr> </table>			No. 020-725 METRIC CAP SCREWS and Nuts 255 Cap Screws - 255 Nuts - 60 Lock Nuts		No. 020-726 METRIC CAP SCREWS and Nuts 83 Cap Screws - 83 Nuts - 20 Lock Nuts		No. 020-727 METRIC FLAT WASHERS, SPRING WASHERS, LOCK WASHERS			M4 x 16	M6 x 30	M8 x 12	M10 x 30	425 pcs. Flat Washers	125 pcs. Spring Washers	450 pcs. Lock Washers	M5 x 12	M6 x 35	M8 x 16	M10 x 40	4mm	4mm	4mm	M5 x 16	M6 x 45	M8 x 20	M10 x 50	5mm	5mm	5mm	M5 x 20	M4 Hex Nuts	M8 x 25	M10 x 60	6mm	6mm	6mm	M5 x 25	M5	M8 x 30	M10 x 70	8mm	8mm	8mm	M6 x 12	M6	M8 x 40	M8 Hex Nuts	10mm	10mm	10mm	M6 x 16	M4 Locknuts	M8 x 50	M10				M6 x 20	M5	M8 x 60	M8 Locknuts				M6 x 25	M6	M8 x 70	M10			
No. 020-725 METRIC CAP SCREWS and Nuts 255 Cap Screws - 255 Nuts - 60 Lock Nuts		No. 020-726 METRIC CAP SCREWS and Nuts 83 Cap Screws - 83 Nuts - 20 Lock Nuts		No. 020-727 METRIC FLAT WASHERS, SPRING WASHERS, LOCK WASHERS																																																																				
M4 x 16	M6 x 30	M8 x 12	M10 x 30	425 pcs. Flat Washers	125 pcs. Spring Washers	450 pcs. Lock Washers																																																																		
M5 x 12	M6 x 35	M8 x 16	M10 x 40	4mm	4mm	4mm																																																																		
M5 x 16	M6 x 45	M8 x 20	M10 x 50	5mm	5mm	5mm																																																																		
M5 x 20	M4 Hex Nuts	M8 x 25	M10 x 60	6mm	6mm	6mm																																																																		
M5 x 25	M5	M8 x 30	M10 x 70	8mm	8mm	8mm																																																																		
M6 x 12	M6	M8 x 40	M8 Hex Nuts	10mm	10mm	10mm																																																																		
M6 x 16	M4 Locknuts	M8 x 50	M10																																																																					
M6 x 20	M5	M8 x 60	M8 Locknuts																																																																					
M6 x 25	M6	M8 x 70	M10																																																																					
No. 020-728 METRIC SOCKET SET SCREWS and KEYS METRIC MACHINE SCEWS and NUTS 100 Socket Set Screws 4 Keys - 140 Machine Screws, 140 Nuts		No. 020-729 METRIC COTTER PINS & SLOTTED SPRING PINS 675 Cotter Pins - 160 Spring Pins																																																																						
Socket Set Screws		Machine Screws		Cotter Pins																																																																				
M4 x 5	M8 x 8	M4 x 6	M6 x 16	1.5 x 16	2 x 16	4 x 50																																																																		
M4 x 10	M8 x 12	M4 x 12	M6 x 20	2 x 20	2.5 x 18	5 x 36																																																																		
M5 x 10	M8 x 20	M5 x 10	M4 Nuts	3 x 25	3 x 24	5 x 50																																																																		
M5 x 15	M2 Keys	M5 x 16	M5	3 x 40	3 x 40	6 x 22																																																																		
M6 x 8	M2.5	M6 x 10	M6	4 x 50	4 x 18	6 x 50																																																																		
M6 x 12	M3				4 x 36																																																																			
M6 x 20	M4																																																																							

METRIC GARAGE ASSORTMENTS

Most popular METRIC FASTENERS packed in divided plastic containers.

No. 020-125 METRIC CAP SCREWS 82 pieces - 7 sizes		No. 020-126 METRIC CAP SCREWS 25 pieces - 7 sizes		No. 020-127 METRIC HEX NUTS 110 pieces - 6 sizes		
M4 x 16	M6 x 16	M8 x 16	M10 x 30	M4	M6	M10
M5 x 16	M6 x 25	M8 x 20	M10 x 40	M5	M8	M12
M5 x 20	M6 x 35	M8 x 25	M10 x 50	No. 020-130 METRIC LOCK WASHERS 300 pieces - 5 sizes		
M5 x 25		M8 x 35		4mm	6mm	10mm
No. 020-128 METRIC NYLON COLLAR LOCK NUTS 33 pieces - 5 sizes		No. 020-129 METRIC FLAT WASHERS 235 pieces - 5 sizes		5mm	8mm	
M4	M8	4mm	8mm	6mm	10mm	
M5	M10	5mm	10mm	8mm		
M6		6mm		No. 020-133 METRIC MACHINE SCREWS and NUTS 105 Screws, 7 sizes - 105 nuts, 3 sizes		
No. 020-131 METRIC SPRING WASHERS 250 pieces - 5 sizes		No. 020-132 METRIC SOCKET SET SCREWS 29 pieces - 10 sizes		M4 x 6	M6 x 10	M4 Hex Nuts
4mm	8mm	M4 x 5	M6 x 12	M4 x 12	M6 x 16	M5
5mm	10mm	M4 x 10	M6 x 20	M5 x 10	M6 x 20	M6
6mm		M5 x 10	M8 x 8	M5 x 16		
		M5 x 15	M8 x 12	No. 020-134 METRIC COTTER PINS 275 pieces - 5 sizes		
		M6 x 8	M8 x 20	1.5 x 16	3 x 25	4 x 50
No. 020-135 METRIC SLOTTED SPRING PINS 64 pieces - 8 sizes				2 x 20	3 x 40	
2 x 16	3 x 40	4 x 36	5 x 50	For SUPER-SERVICE ASSORTMENT No. 020-842 of Metric Fasteners refer to page 9.		
2.5 x 18	4 x 18	5 x 36	6 x 50			



GRADE 5 HEX HEAD CAP SCREWS BOULONS DE PRECISION CLASSE 5

• MADE TO S.A.E.
J429 SPECIFICATIONS

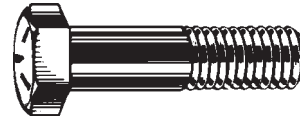

- MEDIUM CARBON STEEL
- DOUBLE HEAT TREATED
- BARE METAL

073
UNC
Coarse

"Papco" Grade 5 Cap Screws, identified by the three radial bar head marking, are made of medium carbon steel, quenched and tempered for higher tensile strength and holding power. Tensile Strength: up to 1" dia. -120,000 p.s.i.(min.) 1-1/8" dia. up -105,000 p.s.i.(min.)

074
UNF
Fine

ORDER BY STOCK NUMBER

UNC Coarse Thread, add prefix 073

UNF Fine Thread, add prefix 074

Example of Stock No. 073-586 is 1/2 x 2 Coarse Thread Grade 5 Cap Screw Bare Metal.

Threads UNC	20	18	16	14	13	12	11	10	9	8	7	7	6
UNF	28	24	24	20	20	18	18	16	14	14	12	12	12
Diameter	1/4	5/16	3/8	7/16	1/2	9/16	5/8	3/4	7/8	1"	1-1/8"	1-1/4"	1-1/2"
1/2	-305	-440	-485										
3/4	-307	-442	-487	-532									
1	-309	-444	-489	-534	-579	-623	-668						
1-1/4	-311	-446	-491	-536	-581	-625	-670						
1-1/2	-313	-448	-493	-538	-583	-627	-672	-714					
1-3/4	-315	-450	-495	-540	-585	-629	-674	-716	-761	-802			
2	-316	-451	-496	-541	-586	-630	-675	-717	-762	-803			
2-1/4	-317	-452	-497	-542	-587	-631	-676	-718	-763	-804			
2-1/2	-318	-453	-498	-543	-588	-632	-677	-719	-764	-805	-845	-885	
2-3/4	-319	-454	-499	-544	-589	-633	-678	-720					
3	-320	-455	-500	-545	-590	-634	-679	-721	-766	-807	-847	-887	
3-1/2	-322	-457	-502	-547	-592	-636	-681	-723	-768	-809*	-849	-889	
4	-324	-459	-504	-549	-594	-638	-683	-725	-770	-811*	-851	-891	-961
4-1/2	-325	-460	-505	-550	-595	-639	-684	-726	-771	-812*	-852	-892	-962
5	-326	-461	-506*	-551	-596	-640	-685	-727	-772	-813*	-853	-893	-963
5-1/2	-327	-462	-507*	-552	-597	-641	-686	-728	-773*	-814*	-854	-894	-964
6	-329	-464	-509*	-554	-599*	-643	-688	-730	-775*	-816*	-856	-896	-966
7					-601*		-690	-732	-777*	-818*	-858	-898	-968
8					-603*		-692	-734	-779*	-820*	-860	-900	-970
Head Width Across Flats	7/16	1/2	9/16	5/8	3/4	13/16	15/16	1-1/8	1-5/16	1-1/2	1-11/16	1-7/8	2-1/4
Head Height	5/32	13/64	15/64	9/32	5/16	23/64	25/64	15/32	35/64	39/64	11/16	25/32	15/16
Std. Packages	100	100	100 *50	50	50 *25	25	25	20	20 *10	20 *10	As Required		

085
UNC
Coarse

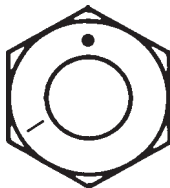

GRADE 5 HEX NUTS ECROUS HEX CLASSE 5



086
UNF
Fine

• MADE TO STANDARD FINISHED
HEXAGON NUT DIMENSIONS

• BARE METAL

Diameter	1/4	5/16	3/8	7/16	1/2	9/16	5/8	3/4	7/8	1"
Stock No. UNC Coarse	085-014	085-016	085-018	085-020	085-022	085-023	085-024	085-026	085-028	085-030
UNF Fine	086-014	086-016	086-018	086-020	086-022	086-023	086-024	086-026	086-028	086-030
Std. Pkgs.	100	100	100	50	50	25	25	20	20	20

For Grade 2 Plated and Bare Hex Nuts see page 31.



GRADE 2 HEX HEAD CAP SCREWS BOULONS DE PRECISION CLASSE 2

069
UNC
Bare

"Papco" Grade 2 Cap Screws are made from low carbon steel and have no head bar markings. Tensile Strength: up to 5/8" dia. -64,000 p.s.i.(min.) 3/4" dia. up -55,000 p.s.i.(min.)

ORDER BY STOCK NUMBER

UNC Coarse Thread Zinc Plated, add prefix 071

Example of Stock No. 071-586 is 1/2 x 2 Coarse Thread Grade 2 Cap Screw Zinc Plated.

071
UNC
Plated

Note: Bolt strength is indicated by head marking. Do not replace with a lower grade than the original.



papco[®] PLATED GRADE 5 HEX HEAD CAP SCREWS BOULONS DE PRECISION CLASSE 5 PLAQUE

- MEDIUM CARBON STEEL
- MADE TO S.A.E. J429 SPECIFICATIONS



- DOUBLE HEAT TREATED
- BRIGHT ELECTRO-PLATED WITH CHROMATE FINISH

"Papco" Plated Grade 5 Cap Screws are identified by the three radial bar head marking and are made of medium carbon steel, quenched and tempered for higher tensile strength and holding power. Bright electro-plated with chromate finish to resist rust. Tensile Strength: up to 1" dia. -120,000 p.s.i.(min.) 1-1/8" dia. up -105,000 p.s.i.(min.)

075
UNC
Coarse

076
UNF
Fine

ORDER BY STOCK NUMBER

UNC Coarse Thread Plated, add prefix 075 UNF Fine Thread Plated, add prefix 076
Example of Stock No. 075-586 is 1/2 x 2 Coarse Thread Plated Grade 5 Cap Screw.

Threads UNC	20	18	16	14	13	12	11	10	9	8	7	7	6
UNF	28	24	24	20	20	18	18	16	14	14	12	12	12
Diameter	1/4	5/16	3/8	7/16	1/2	9/16	5/8	3/4	7/8	1"	1-1/8"	1-1/4"	1-1/2"
1/2	-305	-440											
3/4	-307	-442	-487	-532									
1	-309	-444	-489	-534	-579	-623	-668						
1-1/4	-311	-446	-491	-536	-581	-625	-670						
1-1/2	-313	-448	-493	-538	-583	-627	-672	-714					
1-3/4	-315	-450	-495	-540	-585		-674	-716					
2	-316	-451	-496	-541	-586	-630	-675	-717	-762				
2-1/4	-317	-452	-497		-587		-676	-718	-763				
2-1/2	-318	-453	-498	-543	-588	-632	-677	-719	-764	-805			
2-3/4													
3	-320	-455	-500	-545	-590	-634	-679	-721	-766	-807		-887	
3-1/2	-322	-457	-502	-547	-592		-681	-723	-768	-809*			
4	-324	-459	-504	-549	-594		-683	-725	-770	-811*		-891	
4-1/2	-325	-460	-505		-595		-684	-726	-771	-812*			
5	-326	-461	-506*		-596		-685	-727	-772	-813*		-893	
5-1/2					-597		-686	-728	-773*	-814*			
6			-509*	-554	-599*		-688	-730	-775*	-816*		-896	
7													
8													
Head Width Across Flats	7/16	1/2	9/16	5/8	3/4	13/16	15/16	1-1/8	1-5/16	1-1/2	1-11/16	1-7/8	2-1/4
Head Height	5/32	13/64	15/64	9/32	5/16	23/64	25/64	15/32	35/64	39/64	11/16	25/32	15/16
Std. Packages	100	100	100 *50	50	50 *25	25	25	20	20 *10	20 *10	As Required		

087
UNC
Coarse

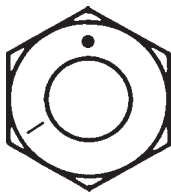

papco[®] PLATED GRADE 5 HEX NUTS ECROUS HEX CLASSE 5 PLAQUE

- BRIGHT ELECTRO-PLATED WITH CHROMATE FINISH



- MADE TO STANDARD FINISHED HEXAGON NUT DIMENSIONS



088
UNF
Fine

Diameter	1/4	5/16	3/8	7/16	1/2	9/16	5/8	3/4	7/8	1"
Stock No. UNC Coarse	087-014	087-016	087-018	087-020	087-022	087-023	087-024	087-026	087-028	087-030
UNF Fine	088-014	088-016	088-018	088-020	088-022	088-023	088-024	088-026	088-028	088-030
Std. Pkgs.	100	100	100	50	50	25	25	20	20	20

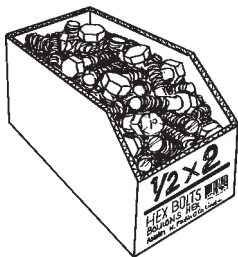

papco[®] PLATED BULK FASTENERS

1/8 keg - 25 lbs. (maximum)

BRIGHT ELECTRO-PLATED WITH CHROMATE FINISH



"Papco" Plated Grade 5 Cap Screws, Hex Nuts, Washers, Carriage Bolts, Lag Bolts and screw products series No. 845. See price book for bulk quantities and sizes.



papeco[®] CAP SCREW and NUT ASSORTMENTS ASSORTIMENTS DE BOULONS DE PRECISION et ECROUS

CAP SCREW AND NUT UTILITY ASSORTMENTS



Each size in these popular assortments is in a separate compartment in a sturdy fibre-board container. Plated Grade 5 Cap Screws and Nuts. Dimensions and retail codes shown in lid.

No. 020-326 contains 105 Fine Thread Screws in sizes from 1/4 x 3/4 to 1/2 x 1-1/2.

No. 020-327 contains 105 Coarse Thread Screws in sizes from 1/4 x 3/4 to 1/2 x 1-1/2.

No. 020-347 contains 133 Hexagon Nuts in Fine, and Coarse sizes from 1/4" to 1/2" Diameter.

CAP SCREW AND NUT MASTER ASSORTMENTS



Packed in metal, sectional divided box with moulded plastic compartments. The hinged, safety-lock lid may be closed and carried to the job. Contains the most popular sizes of Plated Grade 5 Cap Screws.

MASTER ASSORTMENT No. 020-622

Contains 20 best sizes of Plated Grade 5 Screws, Nuts, Washers, Stove Bolts and Cotter Pins.

U N C CAP SCREWS — 1/4 x 3/4; 1/4 x 1; 5/16 x 3/4; 5/16 x 1; 3/8 x 1; 3/8 x 1-1/2.

U N C NUTS — 1/4 ; 5/16 ; 3/8. LOCKWASHERS — 1/4 ; 5/16 ; 3/8.

S.A.E WASHERS — 1/4 ; 5/16 ; 3/8. STOVEBOLTS — 3/16 x 1 ; 1/4 x 3/4 ; 1/4 x 1.

COTTER PINS — 3/32 x 1 ; 1/8 x 2.

Have all the MOST USED sizes of Fasteners available when you need them.

No. 020-646 Contains 208 Plated Grade 5, UNF Fine Thread Cap Screws — 20 sizes.

No. 020-647 Contains 208 Plated Grade 5, UNC Coarse Thread Cap Screws — 20 sizes.

No. 020-648 Contains 376 Plated Hex Nuts, Coarse, Fine, and Castellated — 18 sizes.

COMPARATIVE STRENGTH OF CAP SCREWS

MINIMUM TENSILE STRENGTH p. s. i. (pounds per sq. inch)	S.A.E. Grades 2, 5, 8 and 'Papcolloy'	I.S.O. Metric Property Classes	MINIMUM TENSILE STRENGTH MPa (megapascals)
180,000	'PAPCOLLOY'	CLASS 12.9	1220
170,000	GRADE 8	CLASS 10.9	1040
160,000	GRADE 5	CLASS 9.8	900
150,000		CLASS 8.8	830
140,000		CLASS 5.8	520
130,000	GRADE 2		
120,000			
110,000			
100,000			
90,000			
80,000			
70,000			
60,000			
50,000			
	1/4, 5/16, 3/8, 7/16, 1/2, 9/16, 5/8, 3/4, 7/8, 1", 1-1/8, 1-1/4, 1-3/8, 1-1/2	M5 — — M16 — — M24 — — M36	
	Diameter (inches)	Diameter (millimetres)	



GRADE 8 HEX HEAD CAP SCREWS BOULONS DE PRECISION CLASSE 8



077
Coarse
Bare

- MEDIUM CARBON ALLOY STEEL
- SIX RADIAL BARS
- DOUBLE HEAT TREATED



- MADE TO S.A.E. J429 SPECIFICATIONS
- GOLD ZINC DICHROMATE PLATED OR BARE METAL

078
Fine
Bare

079
Coarse
Plated

"Papco" Grade 8 Cap Screws, identified by the six radial bar head marking, are made of medium carbon alloy steel, quenched and tempered for stronger, safer, more reliable mechanical joints. Use with Grade 8 Nuts to develop the full strength of the Cap Screw. Tensile Strength: 150,000 p.s.i. (min.).

080
Fine
Plated

ORDER BY STOCK NUMBER

Plated UNC Coarse Thread, add prefix 079 Plated UNF Fine Thread, add prefix 080
Example of Stock No. 079-586 is 1/2 x 2 Coarse Thread Plated Grade 8 Cap Screw.

Threads UNC	20	18	16	14	13	12	11	10	9	8	7	7	6
UNF	28	24	24	20	20	18	18	16	14	14	12	12	12
Diameter	1/4	5/16	3/8	7/16	1/2	9/16	5/8	3/4	7/8	1"	1-1/8"	1-1/4"	1-1/2"
1/2	-305	-440											
3/4	-307	-442	-487										
1	-309	-444	-489	-534	-579		-668						
1-1/4	-311	-446	-491	-536	-581								
1-1/2	-313	-448	-493	-538	-583		-672	-714					
1-3/4	-315	-450	-495	-541	-585		-674						
2	-316	-451	-496	-541	-586		-675	-717	-762	-803			
2-1/4	-317	-452	-497	-541	-587		-676						
2-1/2	-318	-453	-498	-543	-588		-677	-719	-764	-805			
2-3/4													
3	-320	-455	-500	-545	-590		-679	-721	-766	-807		-887	
3-1/2	-322	-457	-502	-547	-592		-681	-723	-768	-809*			
4	-324	-459	-504	-549	-594		-683	-725	-770	-811*		-891	
4-1/2				-550	-595		-684	-726					
5	-326	-461	-506*	-551	-596		-685	-727	-772	-813*		-893	
5-1/2													
6	-329	-464	-509*	-554	-599*		-688	-730	-775*	-816*		-896	
7							-690	-732	-777*	-818*			
8							-692	-734	-779*	-820*		-900	
Head Width Across Flats	7/16	1/2	9/16	5/8	3/4	13/16	15/16	1-1/8	1-5/16	1-1/2	1-11/16	1-7/8	2-1/4
Head Height	5/32	13/64	15/64	9/32	5/16	23/64	25/64	15/32	35/64	39/64	11/16	25/32	15/16
Std. Packages	100	100	100 *50	50	50 *25		25	20	20 *10	20 *10	As Required		

089
Coarse
Bare



GRADE 8 HEX NUTS ECROUS HEX CLASSE 8

090
Fine
Bare

091
Coarse
Plated

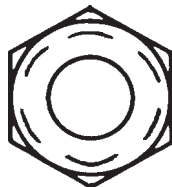

FINISHED



- GOLD ZINC DICHROMATE PLATED OR BARE
- MADE TO STANDARD FINISHED HEXAGON NUT DIMENSIONS

092
Fine
Plated

Diameter	1/4	5/16	3/8	7/16	1/2	9/16	5/8	3/4	7/8	1"
Stock No.	-014	-016	-018	-020	-022		-024	-026	-028	-030
Across Flats	7/16	1/2	9/16	11/16	3/4		15/16	1-1/8	1-5/16	1-1/2
Std. Pkgs.	100	100	100	50	50		25	20	20	20

For Grade 8 Flat Washers see 101 Series Tension Washers - Lock Washers see 101 Series 'Papcolloy' Lock Washers, pages 32 and 33.



papeco[®] HEX NUTS ECROUS HEX

FINISHED

081
UNC
Coarse

**GRADE 2
HEX NUTS***
(Finished)

082
UNF
Fine



BARE
METAL

**PLATED
GRADE 2
HEX NUTS**
(Finished)

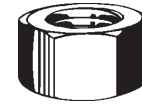

083
UNC
Coarse

084
UNF
Fine

(COARSE THREAD - UNC)
(FINE THREAD - UNF)

(COARSE THREAD - UNC)
(FINE THREAD - UNF)

Stock Number		Size	Std. Pkg.	Width Across Flats	Thickness
UNC Coarse	UNF Fine				
081-014	082-014	1/4	100	7/16	7/32
081-016	082-016	5/16	100	1/2	17/64
081-018	082-018	3/8	100	9/16	21/64
081-020	082-020	7/16	50	11/16	3/8
081-022	082-022	1/2	50	3/4	7/16
081-023	082-023	9/16	25	7/8	31/64
081-024	082-024	5/8	25	15/16	35/64
081-026	082-026	3/4	20	1-1/8	41/64
081-028	082-028	7/8	20	1-5/16	3/4
081-030	082-030	1	20	1-1/2	55/64
081-032	082-032	1-1/8	15	1-11/16	31/32
081-034	082-034	1-1/4	15	1-7/8	1-1/16
081-037	082-037	1-3/8	10	2-1/16	1-11/64
081-038	082-038	1-1/2	10	2-1/4	1-9/32

Stock Number		Size	Std. Pkg.	Width Across Flats	Thickness
UNC Coarse	UNF Fine				
083-014	084-014	1/4	100	7/16	7/32
083-016	084-016	5/16	100	1/2	17/64
083-018	084-018	3/8	100	9/16	21/64
083-020	084-020	7/16	50	11/16	3/8
083-022	084-022	1/2	50	3/4	7/16
083-023	084-023	9/16	25	7/8	31/64
083-024	084-024	5/8	25	15/16	35/64
083-026	084-026	3/4	20	1-1/8	41/64
083-028	084-028	7/8	20	1-5/16	3/4
083-030	084-030	1	20	1-1/2	55/64

**UNC
HEAVY HEX NUTS***

094
Series

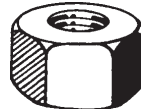

(COARSE THREAD - UNC)

**UNF
THICK SLOTTED HEX NUTS**
(Finished)



093
Series

(FINE THREAD - UNF)

Stock Number	Nut Size and Thread	Std. Pkg.	Width Across Flats	Thickness
094-014	1/4-20	100	1/2	15/64
094-016	5/16-18	100	9/16	19/64
094-018	3/8-16	100	11/16	23/64
094-020	7/16-14	50	3/4	27/64
094-022	1/2-13	50	7/8	31/64
094-023	9/16-12	25	15/16	35/64
094-024	5/8-11	25	1-1/16	39/64
094-026	3/4-10	20	1-1/4	47/64
094-028	7/8-9	20	1-7/16	55/64
094-030	1-8	20	1-5/8	63/64
094-032	1-1/8-7	15	1-13/16	1-7/64
094-034	1-1/4-7	15	2	1-7/32
094-037	1-3/8-6	10	2-3/16	1-11/32
094-038	1-1/2-6	10	2-3/8	1-15/32

Stock Number	Nut Size and Thread	Std. Pkg.	Width Across Flats	Thickness
093-014	1/4-28	100	7/16	9/32
093-016	5/16-24	100	1/2	21/64
093-018	3/8-24	100	9/16	13/32
093-020	7/16-20	50	11/16	29/64
093-022	1/2-20	50	3/4	9/16
093-023	9/16-18	25	7/8	39/64
093-024	5/8-18	25	15/16	23/32
093-026	3/4-16	20	1-1/8	13/16
093-028	7/8-14	20	1-5/16	29/32
093-030	1-14	20	1-1/2	1
093-032	1-1/8-12	15	1-11/16	1-5/32
093-034	1-1/4-12	15	1-7/8	1-1/4
093-037	1-3/8-12	10	2-1/16	1-3/8
093-038	1-1/2-12	10	2-1/4	1-1/2

* Jam Nuts also available in sizes listed.

Note: These Nuts conform to ANSI Standard B18.2.2. Nuts with Left Hand Threads are available.

papcolloy SUPER HIGH STRENGTH FASTENERS



095
UNC
Coarse

- EXCEED S.A.E. GRADE 8 SPECIFICATIONS
- MADE OF ALLOY STEEL
- GOLD ZINC DICHROMATE PLATED



- SPECIAL HIGH HEADS FOR EXTRA WRENCH AREA
- OVER 50% STRONGER THAN GRADE 5 SCREWS
- TWICE THE IMPACT STRENGTH OF GRADE 2 SCREWS

096
UNF
Fine

"Papcolloy" Hexagon Head Cap Screws are the strongest, toughest, hardest, most durable standard fasteners available.

ORDER BY STOCK NUMBER

UNC Coarse Thread, add prefix 095

UNF Fine Thread, add prefix 096

Example of Stock No. 095-586 is 1/2 x 2 Coarse Thread 'Papcolloy' Cap Screw.

Threads UNC	20	18	16	14	13	12	11	10	9	8	7	7	6
UNF	28	24	24	20	20	18	18	16	14	14	12	12	12
Diameter	1/4	5/16	3/8	7/16	1/2	9/16	5/8	3/4	7/8	1"	1-1/8"	1-1/4"	1-1/2"
3/4	-307	-442	-487										
1	-309	-444	-489	-534	-579	-623							
1-1/4	-311	-446	-491	-536	-581	-670							
1-1/2	-313	-448	-493	-538	-583	-627	-672	-714					
1-3/4	-315	-450	-495	-540	-585	-674	-716						
2	-316	-451	-496	-541	-586	-630	-675	-717	-762				
2-1/4			-542	-587	-630	-676	-718	-763					
2-1/2	-318	-453	-498	-543	-588	-632	-677	-719	-764	-805			
2-3/4													
3		-455	-500	-545	-590	-634	-679	-721	-766	-807	-847	-887	
3-1/2		-457	-502	-547	-592	-636	-681	-723	-768	-809	-849	-889	
4			-504	-549	-594	-638	-683	-725	-770	-811	-851	-891	-961
4-1/2					-595		-684	-726	-771	-812	-852	-892	
5					-596		-685	-727	-772	-813	-853	-893	-963
5-1/2							-686	-728	-773	-814			
6					-599*		-688	-730	-775	-816	-856	-896	-966
6-1/2							-698	-731	-776	-817			
7					-601*		-690	-732	-777	-818	-858	-898	-968
8					-603*		-692	-734	-779	-820	-860	-900	-970
Head Width Across Flats	7/16	1/2	9/16	5/8	3/4	13/16	15/16	1-1/8	1-5/16	1-1/2	1-11/16	1-7/8	2-1/4
1* Head Height	3/16	15/64	9/32	21/64	3/8	25/64	27/64	33/64	39/64	43/64	49/64	55/64	1-1/32
Std. Packages	100	100	100	50	50*25	25	25	20	20*10	20*10	As Required		

papcolloy HEXAGON NUTS

097
UNC
Coarse

- MADE TO DEVELOP THE FULL STRENGTH OF 'PAPCOLLOY' CAP SCREWS
- HIGH CARBON HEAT TREATED NUTS
- GOLD ZINC DICHROMATE PLATED



- EXTRA THICKNESS FOR STRENGTH AND WRENCH ENGAGEMENT*
- BOTH UNC AND UNF THREAD SERIES

098
UNF
Fine

Diameter	1/4	5/16	3/8	7/16	1/2	9/16	5/8	3/4	7/8	1"	1-1/8"	1-1/4"	1-1/2"
Stock No. UNC Coarse	097-014	097-016	097-018	097-020	097-022	097-023	097-024	097-026	097-028	097-030	097-032	097-034	097-038
Stock No. UNF Fine	098-014	098-016	098-018	098-020	098-022	098-023	098-024	098-026	098-028	098-030	098-032	098-034	098-038
Across Flats	7/16	1/2	9/16	11/16	3/4	7/8	15/16	1-1/8	1-5/16	1-1/2	1-11/16	1-7/8	2-1/4
* Thickness	.264	.309	.377	.445	.511	.575	.655	.762	.882	1.018	1.176	1.272	1.526
Std. Pkgs.	100	100	100	50	50	25	25	20	20	20	15	15	10



papcolloy TENSION WASHERS

Heat treated, high carbon, plated steel washers. Use two with each "Papcolloy" cap screw and nut to complete the system.

Bolt Diameter	1/4	5/16	3/8	7/16	1/2	9/16	5/8	3/4	7/8	1"	1-1/8"	1-1/4"	1-1/2"
Stock No.	101-114	101-116	101-118	101-120	101-122	101-123	101-124	101-126	101-128	101-130	101-132	101-134	101-138
I.D.	9/32	11/32	13/32	15/32	17/32	19/32	11/16	13/16	15/16	1-1/8	1-1/4	1-3/8	1-5/8
O.D.	5/8	11/16	13/16	59/64	1-1/16	1-3/16	1-5/16	1-15/32	1-3/4	2	2-1/4	2-1/2	3
Max.Thickness	.080	.080	.080	.080	.177	.177	.177	.177	.177	.177	.177	.177	.177
Std. Pkg.	100	100	100	100	50	50	50	40	40	40	20	20	20



papcolloy GRADE C STOVER® LOCKNUTS ECROUS A BLOCAGE `STOVER`®

The Stover® Locknut is an improved ONE-PIECE-REUSABLE-PREVAILING TORQUE locknut of superior locking characteristics which are obtained by accurately modifying the threads in the locking section. Grade 'C' Heat Treated High Strength Stover® Locknuts are made for critical applications. Cadmium Plated and Waxed.

Medium Carbon Steel, Heat Treated



Two sectors of the Stover® Locknut are pre-formed inwardly. When the nut is applied to the bolt, these deflected threads are elastically returned to a circular form and create an inward and downward pressure which produces intimate contact between the load carrying flanks of the nut and bolt threads. The Stover® nut starts freely and then requires wrenching as the out-of-round gripping threads engage the bolt. The prevailing torque enables the stop nut to remain in a fixed position through a wide adjustment range and it retains its locking ability through many reuses.

063
UNC
Coarse

Proof Stress:
150,000 psi.

064
UNF
Fine

Grade 'C'
identified by
eight raised dots.



Order by Stock Number

063-UNC Thread		064-UNF Thread		Standard Package	Width 'A' x Thickness 'B'
Stock No.	Size	Height	Width		
063-014	1/4-20	064-014	1/4-28	100	7/16 x .226
063-016	5/16-18	064-016	5/16-24	100	1/2 x .273
063-018	3/8-16	064-018	3/8-24	100	9/16 x .337
063-020	7/16-14	064-020	7/16-20	50	11/16 x .385
063-022	1/2-13	064-022	1/2-20	50	3/4 x .448
063-023	9/16-12	064-023	9/16-18	25	7/8 x .496
063-024	5/8-11	064-024	5/8-18	25	15/16 x .559
063-026	3/4-10	064-026	3/4-16	20	1-1/8 x .665
063-028	7/8-9	064-028	7/8-14	20	1-5/16 x .776
063-030	1"-8	064-030	1"-14	20	1-1/2 x .887

Used with Grade 5 or Grade 8 Bolts.

Grade 'C' Stover® Locknuts are identified by eight raised dots and are suitable for use with heat treated high carbon and alloy steel bolts including S.A.E. Grade 8. The Cadmium finish resists rust and the pre-lubricant wax coating produces a uniform clamping force.

papcolloy LOCK WASHERS RONDELLES RESORT

EXTRA DUTY

4037 HIGH ALLOY STEEL

101
Series

For use with Grade 5, 8 or 9 bolts and for high load applications.

Mechanical Gold Zinc Dichromate Plated.

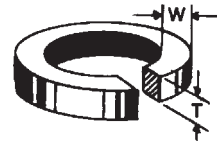

Order by Stock Number

Stock No.	Bolt Size	Std. Pkg.	Steel Section W x T	Stock No.	Bolt Size	Std. Pkg.	Steel Section W x T
101-014	1/4	100	.109 x .062	101-026	3/4	40	.234 x .188
101-016	5/16	100	.125 x .078	101-028	7/8	40	.266 x .219
101-018	3/8	100	.141 x .094	101-030	1"	40	.297 x .250
101-020	7/16	100	.156 x .109	101-032	1-1/8	20	.411 x .375
101-022	1/2	50	.171 x .125	101-034	1-1/4	20	.452 x .417
101-023	9/16	50	.188 x .141	101-038	1-1/2	20	.526 x .496
101-024	5/8	50	.203 x .156				

Papco® GRADE B STOVER® LOCKNUTS ECROUS A BLOCAGE `STOVER®`



Low Carbon Steel

Grade 'B' Stover® Locknuts are all steel one piece construction. Lock in any position - are strong, shock-proof and vibration-proof. Easily installed and reusable - starts freely and then requires wrenching as the out-of-round gripping threads engage the bolt. Cadmium plated to resist rust and wax coated to ensure a uniform clamping force.

061
UNC
Coarse

Proof Stress:
120,000 psi.

062
UNF
Fine

Grade 'B'
identified by
five raised dots.



Order by Stock Number

061-UNC Thread		062-UNF Thread		Standard Package	Width 'A' x Thickness 'B'
Stock No.	Size	Height	Width		
061-014	1/4-20	062-014	1/4-28	100	7/16 x .257
061-016	5/16-18	062-016	5/16-24	100	1/2 x .302
061-018	3/8-16	062-018	3/8-24	100	9/16 x .377
061-020	7/16-14	062-020	7/16-20	50	11/16 x .430
061-022	1/2-13	062-022	1/2-20	50	3/4 x .510
061-023	9/16-12	062-023	9/16-18	25	7/8 x .555
061-024	5/8-11	062-024	5/8-18	25	15/16 x .645
061-026	3/4-10	062-026	3/4-16	20	1-1/8 x .750
061-028	7/8-9	062-028	7/8-14	20	1-5/16 x .862
061-030	1"-8	062-030	1"-14	20	1-1/2 x .958

Used with Grade 2 or Grade 5 Bolts.



STOVER® LOCKNUT ASSORTMENTS

These Assortments contain 90 lock nuts from 1/4" to 1/2" diameter. The container is sectionally divided for ease of selection.

UTILITY ASSORTMENT No. 020-348
Fine Thread (UNF) STOVER® LOCKNUTS

UTILITY ASSORTMENT No. 020-349
Coarse Thread (UNC) STOVER® LOCKNUTS

118
Series

Papco®

FLANGE NUTS ECROUS DE REBORD

BRIGHT ZINC PLATED

'Papco' Flange Nuts provide better load distribution in fastening metal parts, wood or other soft materials. The flange bridges an oversize or elongated hole and eliminates the need for washers.

Two styles:

(A) TENSILOCK - one-piece, hardened, free running lock nuts have ratchet teeth in their base - bite into surface and hold tight under vibration.

(B) STANDARD - in regular and large flange (L) patterns.



Standard

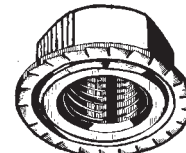

Tensilock

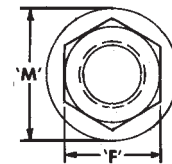

Order by Stock Number

Standard Package 100 Nuts.

Stock No.		Thread Size	Dimensions		
Tensilock	Standard		Hex 'F'	Thick 'H'	Flange 'M'
118-014	118-114	1/4-20	7/16	15/64	19/32
118-016	118-116	5/16-18	1/2	9/32	43/64
	118-117	5/16-18 L	1/2	23/64	13/16
118-018	118-118	3/8-16	9/16	11/32	47/64
	118-119	3/8-16 L	9/16	25/64	29/32
	118-120	7/16-14	11/16	25/64	59/64
118-022	118-122	1/2-13	3/4	29/64	1-1/64

GARAGE ASSORTMENT No. 020-053

Contains 50 locking flange nuts, five sizes from 1/4-20 to 1/2-13. Packed in a clear plastic box. Useful in many repairs where a flange nut is needed.





108
UNC
Coarse

109
UNF
Fine

papeo

'POZI-LOK'® STOP NUTS
ECROUS 'POZI-LOK'®



NYLON INSERT



These prevailing torque locknuts offer excellent vibration resistance and a wide range of adjustment. The nylon collar prevents liquid seepage and internal corrosion. It is smaller than the bolt diameter and as the bolt enters the collar, the thread form is impressed in the nylon. The resulting compressive forces exert constant friction grip on the bolt and prevent loosening. These nuts may be re-used up to 50 times because the "elastic memory" feature of the nylon causes it to return to its original shape. May be used with Grade 2 and Grade 5 Screws up to 250° F. Bright zinc chromate plated.

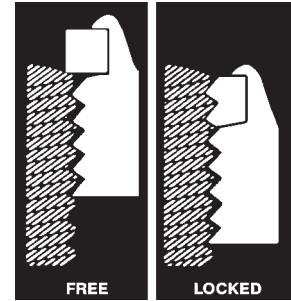

Order by Stock Number

UNC COARSE THREAD		UNF FINE THREAD		Standard Packages	Dimensions	
Stock No.	Size	Stock No.	Size		"A" Width	"B" Thickness
108-006	6-32			100	5/16	.178
108-008	8-32			100	11/32	.229
108-010	10-24	109-010	10/32	100	3/8	.239
108-014	1/4-20	109-014	1/4-28	100	7/16	.313
108-016	5/16-18	109-016	5/16-24	100	1/2	.344
108-018	3/8-16	109-018	3/8-24	100	9/16	.453
108-020	7/16-14	109-020	7/16-20	50	5/8	.453
108-022	1/2-13	109-022	1/2-20	50	3/4	.594
108-023	9/16-12	109-023	9/16-18	25	7/8	.641
108-024	5/8-11	109-024	5/8-18	25	15/16	.750
108-026	3/4-10	109-026	3/4-16	20	1-1/16	.875
108-028	7/8-9	109-028	7/8-14	20	1-1/4	.984
108-030	1-8	109-030	1-14	20	1-7/16	1.047



MASTER ASSORTMENT
No. 020-649

This assortment contains 175 nuts in 16 sizes from 1/4" to 3/4" in both Coarse and Fine Thread. Packed in sturdy, metal box with moulded plastic compartments. Illustrated lid label includes retail price codes.

papeo

'POZI-LOK'® STOP NUT ASSORTMENTS
ASSORTIMENTS ECROUS 'POZI-LOK'®



GARAGE ASSORTMENTS

No. 020-064 UNC Coarse Thread
No. 020-065 UNF Fine Thread
Each contains 40 plated 'Pozi-Lok' Stop Nuts 1/4, 5/16, 3/8, 7/16 and 1/2 diameter. Packed in a clear plastic box.

106
Series

papeo

PANEL NUTS
ECROUS A PANNEAU



Precision made steel and brass thin nuts for volume controls on radios, chassis connections, toggle switches etc. Five popular sizes available.

Order by Stock Number

Standard Package 25 Pieces

Stock No.	Size and Description	Stock No.	Size and Description
106-914	1/4-32 Brass	106-920	7/16-28 Zinc Plated Steel
106-916	3/8-24 Zinc Plated Steel	106-922	1/2-28 Zinc Plated Steel
106-918	3/8-32 Zinc Plated Steel		

papco® DOUBLE THICKNESS NUTS ECROUS TRES HAUT

(Light High Nuts)

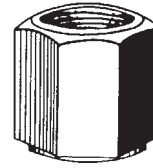

102
Series

"Papco" Double Nuts are used on spring centre bolts, spring "U" bolts, heavy duty truck wheels, tractor and implement bolts.
All Double Thickness Nuts have UNF (S.A.E.) Fine Threads

Order by Stock Number

Standard Package 24 pieces (* 12 pieces)

Stock No.	Size	Height	Width	Stock No.	Size	Height	Width
102-018	3/8-24	17/32	9/16	102-026	3/4-16	1"	1-1/16
102-020	7/16-20	39/64	5/8	102-027	3/4-16	1"	1-1/8
102-022	1/2-20	11/16	3/4	*102-028	7/8-14	1-5/32	1-1/4
102-023	9/16-18	49/64	7/8	*102-030	1-14	1-5/16	1-7/16
102-024	5/8-18	27/32	15/16	*102-034	1 1/4-12	1-11/16	1-13/16

For Spring Centre Bolts see page 113.

103
Series

papco® WING NUTS ECROUS A OREILLE

Strong, well-finished nuts made of cold forged steel. Feature recessed wings for good finger grip. Bright, rust-resistant finish.



Order by Stock Number

Standard Package contains 50 pieces

Size	10-24	1/4-20	5/16-18	3/8-16	7/16-14	1/2-13
Stock No.	103-010	103-014	103-016	103-018	103-020	103-022

For Air Cleaner Wing Nuts see page 124.



No. 020-310

WING NUT UTILITY ASSORTMENT No. 020-310

Contains 151 Wing Nuts in five popular sizes. Sturdy fibreboard display box, ideal for Automotive and Hardware use. Each size in an individual compartment.

papco® ACORN (CAP) NUTS ECROUS BORGNE A CALOTTE

104
Series

Durable, smooth-finished Cap Nuts
Zinc Alloy, Bright Nickel Plated or Zinc Plated Steel

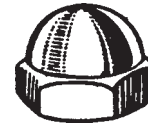

Order by Stock Number

Zinc Alloy Stock No.	Steel Stock No.	Size and Thread	Std. Pkg.	Zinc Alloy Stock No.	Steel Stock No.	Size and Thread	Std. Pkg.
104-006	104-106	6-32	100	104-016	104-116	5/16-18	100
104-008	104-108	8-32	100	104-017	—	5/16-24	100
104-010	104-110	10-24	100	104-018	104-118	3/8-16	100
104-011	104-111	10-32	100	104-019	—	3/8-24	100
104-014	104-114	1/4-20	100	104-022	—	1/2-13	100
104-015	—	1/4-28	100				

ACORN (CAP) NUT UTILITY ASSORTMENT No. 020-336

Contains 87 Acorn Nuts in the following popular sizes:
6-32, 8-32, 10-24, 1/4-20, 5/16-18, 3/8-16, 1/2-13.
Each size is in an individual compartment in a sturdy fibreboard box.



No. 020-336



papco® 'POZI-LOK'® DOUBLE NUTS ECROUS TRES HAUT 'POZI-LOK'®

111
Series

These Nylon Insert, prevailing torque lock nuts offer excellent vibration resistance and assure positive locking under sever shock. Used for Spring Centre Bolts. Spring U-Bolts etc. UNF Fine Thread.

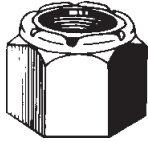

Order by Stock Number

Standard Package 5 pieces

Stock No.	Size	Dimensions	
		Width "A"	Thickness "B"
111-018	3/8-24	35/64	41/64
111-020	7/16-20	5/8	49/64
111-022	1/2-20	3/4	13/16
111-024	5/8-18	15/16	1"

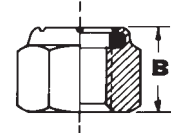
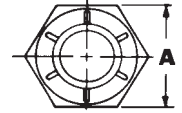

112
Series

papco® 'UNI-NUT'® ALL-NYLON LOCK NUTS ECROUS A BLOCAGE NYLON 'UNI-NUT'®

Can be used with any thread design.

Self-Tapping - Self-Locking

ONE NUT FITS ANY TYPE OF SCREW THREAD

One piece washer base Hexagon prevailing torque Nylon Lock Nuts. These nuts lock against sever vibration - at any point on the screw thread - are rust-proof and electrical insulating - can be re-used. 'Papco' Uni-Nuts will fit Fine and Coarse threads, British, Metric and spaced thread screws. Useful in emergencies.

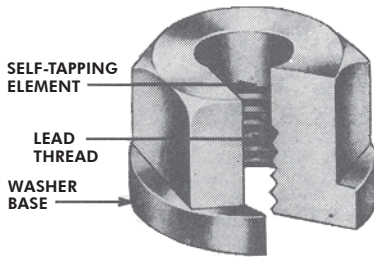

Order by Stock Number

Standard Package 100 pieces

Stock No.	Screw or Bolt Size	Width Across Flats	Width Across Washer	Overall Height
112-004	No. 4	1/4	.275-.289	11/64
112-006	No. 6	5/16	.344-.361	13/64
112-008	NO. 8	11/32	.378-.397	15/64
112-010	No. 10	3/8	.413-.434	1/4
112-014	No. 14 (1/4")	7/16	.482-.506	9/32
112-016	5/16"	.555	.635	.330
112-018	3/8"	.610	.710	.405

GARAGE ASSORTMENTS No. 020-066



Contains 45 Nylon Lock Nuts sizes No. 4 to 3/8". Packed in clear plastic container.

119
Series

papco® 'KEPS' LOCKNUT ASSEMBLIES ECROUS A BLOCAGE 'KEPS'



Consists of a pre-assembled hexagon nut and a tooth lock washer. The tapered, twisted locking teeth provide full locking action when the nut is seated. American Standard Machine Screw Sizes. Bright Plated.

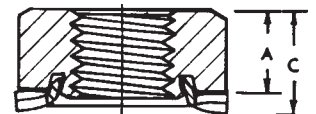

Order by Stock Number

Standard Package 100 Pieces

Stock No.	Keps Nut Size	Width Across Flats	Overall Thickness (C)	Nut Thickness (A)
119-006	6-32	5/16	9/64	7/64
119-008	8-32	11/32	5/32	1/8
119-010	10-24	3/8	5/32	1/8
119-011	10-32	3/8	5/32	1/8
119-014	1/4-20	7/16	15/64	3/16
119-015	1/4-28	7/16	15/64	3/16
119-016	5/16-18	1/2	11/32	9/32
119-018	3/8-16	9/16	7/16	3/8

GARAGE ASSORTMENTS No. 020-055

This Assortment contains 75 'KEPS' Locknuts in each of the sizes listed. Packed in a sturdy four-compartment clear plastic box with a hinged lid.

129
Series

papco

**PLATED CARRIAGE BOLTS
BOULONS DE CARROSSE PLAQUE**

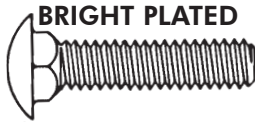

Used extensively for Truck Rack and Floor-board construction or repair. Fully threaded for proper fit and adjustment in wood.

Order by Stock Number

Length Overall	Bolt Diameter							
	1/4	Std. Pkg.	5/16	Std. Pkg.	3/8	Std. Pkg.	1/2	Std. Pkg.
3/4	129-307	100	129-442	100	129-487	100		
1	129-309	100	129-444	100	129-489	100	129-579	50
1-1/4	129-311	100	129-446	100	129-491	100	129-581	50
1-1/2	129-313	100	129-448	100	129-493	100	129-583	50
2	129-316	100	129-451	100	129-496	100	129-586	50
2-1/2	129-318	100	129-453	100	129-498	100	129-588	50
3	129-320	100	129-455	100	129-500	100	129-590	50
3-1/2	129-322	100	129-457	100	129-502	100	129-592	50
4	129-324	100	129-459	100	129-504	100	129-594	50
4-1/2	129-325	100	129-460	100	129-505	100	129-595	50
5	129-326	100	129-461	100	129-506	50	129-596	25
6	129-329	100	129-464	50	129-509	50	129-599	25
8					129-513	50	129-603	25
10					129-517	10	129-607	10
12					129-520	10	129-610	10

Note: Plated Grade 5 Carriage Bolts are available. See current price list. Full shank Carriage Bolts available upon request.



papco CARRIAGE BOLT

UTILITY ASSORTMENT No. 020-330

This Assortment contains 70 Plated Bolts and Nuts, 14 sizes. Each size in a compartment in a sturdy fibre-board container with retail prices shown. Particularly useful for farm, garage and general repair work.

133
Series

papco

**PLATED GRADE 5 PLOW BOLTS
BOULONS DE CHARRUE CLASSE 5 PLAQUE**



- HIGH CARBON STEEL
- DOUBLE HEAT TREATED

'Papco' Plow Bolt heads are round, countersunk with a square neck. Oversize heads for 3/8 dia. are 7/16 dia. head and 7/16 dia. is 1/2 dia. head. Length is measured overall from end of bolt to the top of the head. Other heads and styles are available.

Order by Stock Number

Standard Packages: 3/8" dia. 100; 7/16" and 1/2" dia. 50; 5/8" dia. 25

Length Overall	STANDARD HEAD				OVERSIZE HEAD	
	3/8	7/16	1/2	5/8	3/8	7/16
1	133-489	133-534	—	—	—	—
1-1/4	133-491	133-536	133-581	—	133-791	—
1-1/2	133-493	133-538	133-583	133-672	133-793	—
1-3/4	133-495	133-540	133-585	133-674	133-795	133-816
2	133-496	133-541	133-586	133-675	—	133-820
2-1/4	—	—	—	133-676	—	133-822
2-1/2	133-498	133-543	133-588	133-677	—	133-824
3	—	133-545	133-590	133-679	—	—

Note: 'Papco' Dome Head Scraper (Blade) Bolts, made to S.A.E. Grade 8 Specs. are available in 5/8, 3/4, 7/8, 1" Diameters.



135
Series

papco PLATED LAG BOLTS
TIRE-FOND PLAQUE

Hex Head



Sharp Gimlet Point

Order by Stock Number

Standard Packages = 100, *50, **25.

DIA. LENGTH	1/4	5/16	3/8	1/2
1	135-309	135-444		
1-1/4	135-311	135-446		
1-1/2	135-313	135-448	135-493	
2	135-316	135-451	135-496	*135-586
2-1/2	135-318	135-453	135-498	*135-588
3	135-320	135-455	135-500	*135-590
3-1/2	135-322	135-457	135-502	*135-592
4	135-324	135-459	135-504	*135-594
4-1/2	135-325	135-460	135-505	*135-595
5	135-326	135-461	*135-506	*135-596
6	135-329	135-464	*135-509	**135-599
7	—	—	*135-511	**135-601
8	—	—	*135-513	**135-603

Length of Lag Bolt is measured from under head to end of point.

Thread is one-half of length plus 1/2".

Larger and longer sizes are available.

papco LAG BOLT SHIELDS
CHEVILLES POUR TIRE-FONDS



Papco Lag Shields are a screw type anchor designed to be used with Lag Screws. Short type shields are used in harder masonry materials to reduce drilling time. The Long version is used in soft masonry to develop better holding strength. For use in concrete or mortar joints of brick or block walls.

Order by Stock Number

Lag Screw	1/4"		5/16"		3/8"		1/2"	
Length	1"	1-1/2"	1-1/4"	1-3/4"	1-3/4"	2-1/2"	2"	3"
Stock No.	135-801	135-803	135-805	135-807	135-809	135-811	135-813	135-815
Drill Hole	1/2"	1/2"	1/2"	1/2"	5/8"	5/8"	3/4"	3/4"
Std. Pkg.	25	25	25	15	20	10	10	10

For Masonry Drill Bits see page 176.

136
Series

papco SQUARE HEAD SET SCREWS
VIS DE PRESSION A TETE CARREE

Case Hardened,
Cup Point



Coarse Thread
(UNC)

Stock No.	Size	Stock No.	Size	Stock No.	Size	Stock No.	Size	Stock No.	Size
136-303	1/4 x 3/8	136-440	5/16 x 1/2	136-485	3/8 x 1/2	136-532	7/16 x 3/4	136-577	1/2 x 3/4
136-305	1/4 x 1/2	136-442	5/16 x 3/4	136-487	3/8 x 3/4	136-534	7/16 x 1	136-579	1/2 x 1
136-307	1/4 x 3/4	136-444	5/16 x 1	136-489	3/8 x 1	136-536	7/16 x 1-1/4	136-581	1/2 x 1-1/4
136-309	1/4 x 1	136-446	5/16 x 1-1/4	136-493	3/8 x 1-1/2	136-538	7/16 x 1-1/2	136-583	1/2 x 1-1/2
136-313	1/4 x 1-1/2	136-448	5/16 x 1-1/2	136-496	3/8 x 2	136-541	7/16 x 2	136-586	1/2 x 2
Std. Pkgs.	100	100	100	100	50	50	50	50	

The length of a square head set screw is measured from under the head to the extreme point.

Screws are threaded entire length of the body.

GARAGE ASSORTMENT No. 020-046

Contains 35 Square Head Set Screws in 10 sizes. Packed in transparent plastic box with hinged lid.

MASTER ASSORTMENT No. 020-636

This assortment contains 82 screws, 20 popular sizes, and is packed in a sturdy, metal sectional divided box.

The hinged lid contains an illustrated label with resale prices. Container has locking handle.

UTILITY ASSORTMENT No. 020-344

This assortment contains 66 Square Head Set Screws, 10 popular sizes: 1/4 x 1/2", 5/16 x 3/4", 1", 1-1/2"; 3/8 x 3/4", 1-1/2"; 1/2 x 1", 2".

Packed in a sturdy fibreboard container. The lid label is illustrated and shows retail prices.

papco SOCKET HEAD CAP SCREWS BOULONS DE PRESSION



137
UNC
Coarse

'Papco' Socket Cap Screws are made from Alloy Steel and have a tensile strength of 165,000 p.s.i. Sizes listed are Coarse Thread, UNC. Additional sizes are available.

Alloy Steel

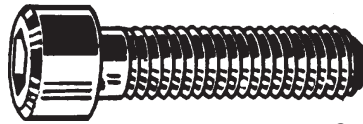

High Strength

Order by Stock Number

Standard Package contains 25 Screws

Stock No.	Size Dia. x Length	Use Wrench No.	Stock No.	Size Dia. x Length	Use Wrench No.
137-305	1/4-20 X 1/2	140-108	137-487	3/8-16 X 3/4	140-111
137-307	3/4		137-489	1	
137-309	1		137-491	1-1/4	
137-311	1-1/4		137-493	1-1/2	
137-313	1-1/2		137-495	1-3/4	
137-315	1-3/4		137-496	2	
137-316	2		137-498	2-1/2	
137-442	5/16-18 x 3/4	140-110	137-583	1/2-13 x 1-1/2	140-112
137-444	1		137-586	2	
137-446	1-1/4		137-588	2-1/2	
137-448	1-1/2				
137-450	1-3/4				
137-451	2				



papco SOCKET HEAD CAP SCREW ASSORTMENT

UTILITY ASSORTMENT No. 020-328

This Assortment contains 36 Socket Head Cap Screws, 12 popular sizes from 1/4 x 3/4 to 1/2 x 2-1/2 coarse thread. Each size is in an individual compartment in a sturdy fibre-board container.

papco SOCKET SET SCREWS VIS DE PRESSION

138
UNC
Coarse



'Papco' Socket Set Screws are made from heat treated Alloy Steel and have ground threads. Sizes listed are standard cup point.



139
UNF
Fine

Order by Stock Number

Standard Package contains 25 Screws

Stock No.	Size Dia. x Length	Use Wrench No.	Stock No.	Size Dia. x Length	Use Wrench No.	Stock No.	Size Dia. x Length	Use Wrench No.
UNC			138-186	10-24 x 5/16	140-103	138-575	1/2-13 x 1/2	140-110
			138-187	3/8		138-576	5/8	
138-081	6-32 x 1/8	140-101	138-301	1/4-20 x 1/4	140-104	138-665	5/8-11 x 5/8	140-111
138-082	3/16		138-302	5/16		UNF		
138-083	1/4		138-303	3/8		139-184	10-32 x 3/16	140-103
138-130	8-32 x 1/8	138-305	1/2	139-185		1/4		
138-132	3/16	138-437	5/16-18 x 5/16	139-186	5/16			
138-133	1/4	140-102	138-438	3/8	140-107	139-301	1/4-28 x 1/4	140-104
138-134	5/16		138-440	1/2	139-303	3/8		
138-135	3/8		138-483	3/8-16 x 3/8	140-108	139-437	5/16-24 x 5/16	
138-184	10-24 x 3/16	138-485	1/2	139-483		3/8-24 x 3/8	140-107	
138-185	1/4	138-486	5/8				104-108	

Note: Additional sizes of Socket Set Screws and Socket Head Cap Screws are available from Stock. For Socket Screw Assortments refer to page 42.



140
Series

papco

SOCKET SCREW KEYS
CLES DE VIS CREUX



"Papco" Socket Screw Keys are made of close tolerance alloy steel. All Keys have chamfered ends for easy insertion. These Keys are available in Short and Long Arm Series. Short Arm Series supplied unless otherwise specified.

Order by Stock Number

Standard Package contains 12 Keys

Stock Numbers		Hex Width Across Flats	Length of Short Arm	Length of Longer Arm		Socket Set	FOR SCREW DIAMETER					
Short Arm	Long Arm			Short Series	Long Series		Socket Head Cap		Flat Head Cap	Button Head Cap	Shoulder Screws	Pipe Plugs
					1960 Series	1936 Series						
140-101	140-201	1/16	9/16	1-3/4		#5, #6		#2	#4	#4		
140-102	140-202	5/64	39/64	1-7/8	3-3/16	#8	#2, #3	#3, #4	#5, #6	#6		
140-103	140-203	3/32	21/32	2	3-3/8	#10, #12	#4, #5	#5, #6	#8	#8		
140-104	140-204	7/64	11/16	2-1/8	3-1/2		#6					
140-105	140-205	1/8	3/4	2-1/4	3-3/4	1/4		#8	#10	#10		
140-106	140-206	9/64	13/16	2-3/8	3-7/8		#8					
140-107	140-207	5/32	27/32	2-1/2	4-1/8	5/16	#10	#10, #12	1/4	1/4	5/16	1/16
140-108	140-208	3/16	15/16	2-3/4	4-1/2	3/8	1/4	1/4	5/16	5/16	3/8	1/8
140-109	140-209	7/32	1-1/32	3	4-7/8	7/16		5/16	3/8	3/8		
140-110	140-210	1/4	1-1/8	3-1/4	5-1/4	1/2, 9/16		5/16	7/16	7/16	1/2	1/4
140-111	140-211	5/16	1-1/4	3-3/4	6	5/8		3/8	3/8, 7/16	1/2	5/8	3/8
140-112	140-212	3/8	1-3/8	4-1/4	6-3/4	3/4	7/16, 1/2	1/2, 9/16	5/8, 3/4	5/8	3/4	1/2

CARD No.
140-852
INCH

papco **SOCKET KEY SETS**
JEU DE CLES

Available in both INCH and METRIC types.
Each "Papco" Socket Key Set is individually carded.
Order by CARD NUMBER.

CARD No.
140-853
METRIC

- 7 popular size Alloy Steel Keys: .050, 1/16, 5/64, 3/32, 3/16.
- Fits Socket Set Screws: No.3 to 3/8" Dia. Socket Cap Screws: No.1 to 1/4" Dia.
- Each key folds into the sturdy steel frame — like a pocket knife blade.
- Can be used in any position.



Card No. 140-852

- 7 popular metric size Alloy Steel Keys: 1.27, 1.5, 2, 2.5, 3, 4, and 5 mm.
- Fits full range of "Papco" Metric Set Screws.
- Closes like a pocket knife when not in use.
- Can be used in any position.

Kit No. 020-858 Short Arm Keys

- Contains 7 Hexagon Alloy Steel Keys, Short Arm Series
- Hex. sizes: 5/64 • 3/32 • 1/8 • 5/32 • 3/16 • 7/32 • 1/4
- Transparent Plastic Case.
- Fit Socket Set Screws from No. 8 to 1/2" Diameter.
- Fit Socket Screws from No. 2 to 5/16" Diameter.
- A professional quality kit made from chrome alloy steel, heat treated to give the best combination of toughness and torsional strength.

(Five 020-858 kits in a master package.)



020-858

UTILITY ASSORTMENT No. 020-335

Contains 52 Keys, 9 sizes.

140 - 102 • 103 • 104 • 107
108 • 109 • 110 • 111 • 112

Packed in a sturdy fibreboard container with illustrated lid label.





SOCKET SET SCREW ASSORTMENTS ASSORTIMENTS VIS DE PRESSION



ASSORTMENT No. 020-855

- Contains 84 Socket Set Screws and 5 Hexagon Keys.
- 10 popular sizes of Set Screws:

8-32 x 3/16	10-24 x 3/16	1/4-20 x 1/4
8-32 x 1/4	10-24 x 1/4	1/4-20 x 3/8
5/16-18 x 5/16	3/8-16 x 3/8	
5/16-18 x 3/8	3/8-16 x 1/2	
- Transparent Styrene Plastic Container.
- Illustrated label shows size and retail prices.
- Refills available in standard packages.



Size: 7" x 4" x 1 1/2"

This assortment is designed for Mechanics, Refrigerator, Oil-Burner and Appliance Servicemen. The re-usable container fits any Tool Kit.

UTILITY ASSORTMENT No. 020-321

Contains 120 Socket Set Screws, 12 popular sizes:

- | | | |
|----------------|----------------|--------------|
| 8-32 x 3/16 | 10-24 x 3/16 | 1/4-20 x 1/4 |
| 8-32 x 1/4 | 10-24 x 1/4 | 1/4-20 x 3/8 |
| 1/4-28 x 1/4 | 5/16-18 x 5/16 | 3/8-16 x 3/8 |
| 5/16-24 x 5/16 | 5/16-18 x 3/8 | 3/8-16 x 1/2 |

Packed in a sturdy fibre board container with a separate compartment for each size. Lid label is illustrated and shows retail prices.



MASTER ASSORTMENT No. 020-629

Contains 166 Socket Set Screws in the following sizes:
(Quantities are adjusted according to popularity)

- | | | |
|--------------|----------------|----------------|
| 8-32 x 3/16 | 10-24 x 3/16 | 3/8-16 x 3/8 |
| 8-32 x 1/4 | 10-24 x 1/4 | 1/2-13 x 1/2 |
| 1/4-20 x 1/4 | 5/16-18 x 5/16 | 10-32 x 3/16 |
| 1/4-20 x 3/8 | 5/16-18 x 3/8 | 1/4-28 x 1/4 |
| 1/4-20 x 1/2 | 5/16-18 x 1/2 | 5/16-24 x 5/16 |

Packed in a rigid all metal lidded box with illustrated lid label showing retail prices. Assortment can be refilled from standard packages.



SUPER SERVICE ASSORTMENT No. 020-803

Contains 240 Socket Set Screws — 32 sizes plus keys.
Large size, rigid metal box with high-strength plastic compartments.

For more details see page 9.

Large size: 12" w. x 18" l. x 3" d.

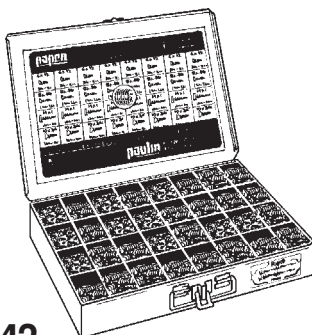



126
Series

papeco HITCH PINS GOUPILLES D'ATTELAGE

HITCH PINS with CLIPS

Designed specifically for quick hitching or unhitching of all types of towed or mobile equipment. Made from high strength, zinc plated steel. Includes Hitch Pin Clip.

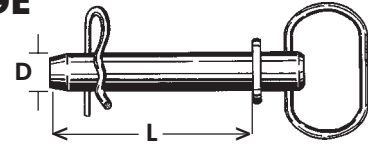

Order by Stock Number

Standard Package 5 Pieces

Stock No.	Size 'D' x 'L'	Usable Length	Stock No.	Size 'D' x 'L'	Usable Length
126-912	1/2 x 4-3/4	4	126-920	3/4 x 7	6-1/4
126-914	5/8 x 4-3/4	4	126-922	7/8 x 7-1/2	6-1/2
126-916	5/8 x 6-3/4	6	126-924	1" x 7-3/4	6-3/4
126-918	3/4 x 5	4-1/4			

papeco HITCH PINS with CHAIN and LYNCH PINS GOUPILLES D'ATTELAGE avec CHAINE et CLAVETTES

All the features of our standard Hitch Pins as described above plus the added protection of an attached 12" chain and lynch pin. All zinc plated steel.

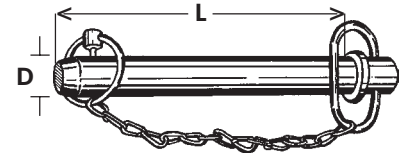

Order by Stock Number

Standard Package 3 Pieces

Stock No.	Size 'D' x 'L'	Usable Length	Stock No.	Size 'D' x 'L'	Usable Length
126-812	1/2 x 4-3/4	4	126-820	3/4 x 7	6-1/4
126-814	5/8 x 4-3/4	4	126-822	7/8 x 7-1/2	6-1/2
126-816	5/8 x 6-3/4	6	126-824	1" x 7-3/4	7
126-818	3/4 x 5	4-1/4			

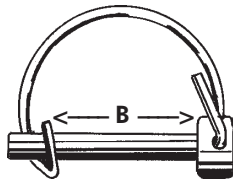

126-900
126-901

papeco WIRE LOCK PINS GOUPILLES DE VERROUILLAGE

WIRE LOCK PINS

126-902
126-906

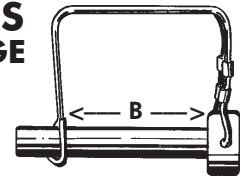

For farm, campers, trucks, boats, trailers, snowmobiles and garden equipment etc. Fits all PTO knuckles and most adaptors. Oil tempered spring remains securely snap-locked.

Order by Stock Number

Standard Package 15 Pieces

Stock No.	Size	Usable Length 'B'	Stock No.	Size	Usable Length 'B'
126-900	1/4 x 3	2-3/4	126-902	5/16 x 2-3/4	2-1/2
126-901	5/16 x 2	1-3/4	126-906	3/8 x 2	1-3/4

126
Series

papeco LYNCH PINS CLAVETTES D'ESSIEU

LYNCH PINS Also known as 'Quick-Pins'

'Papeco' Lynch Pins are heat treated to withstand wear. Spring steel snap ring assembled mechanically to eliminate stretching and loss of tension. Zinc plated to resist rust.

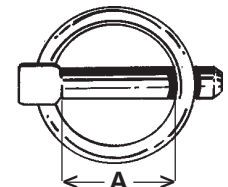

Order by Stock Number

Standard Package 15 Pieces

Stock No.	Pin Size	'A' Grip Length	Stock No.	Pin Size	'A' Grip Length
126-980	3/16 x 1-9/16	1-1/4	126-984	5/16 x 1-9/16	1-1/4
126-982	1/4 x 1-9/16	1-1/4	126-986	7/16 x 1-9/16	1-11/32

For Hitch Pin Clips, Rapid Repair Washers, Cotter Pins, Clevis Pins and Clevis Yokes see index for pages on these items.

126
Series

papeo® SAFETY PINS
EPINGLE SURETE



‘Papco’ Safety Pins are made from hard drawn plated spring wire and afford positive locking action for retaining Clevis and other types of pins. Used on farm equipment, industrial applications, trucks etc. wherever safety is an issue.

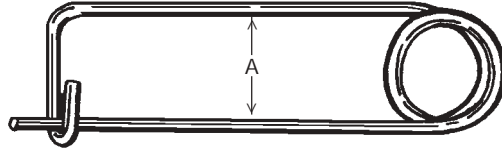

Order by Stock Number

Standard Package 10 Pins

Stock No.	Inside Clearance 'A'	Overall Length	Usable Length	Stock No.	Inside Clearance 'A'	Overall Length	Usable Length
126-932	3/8	1-3/4	1-1/16	126-936	13/16	4-3/8	2-13/16
126-934	5/8	2-3/4	1-11/16	126-938	1-1/8	5-3/4	3-3/4

126
Series

papeo® ROOFING/SIDING SCREWS
VIS DE TOITURE

‘SELF SEALING’

INDENTED HEX WASHER HEAD WITH WEATHERSEALING WASHER

Specially designed screws for attaching metal siding or roofing. Features a neoprene weathersealing washer under the head of screws. High-carbon, zinc plated steel. Also available with painted heads in white, bone, brown and red. Price on application.



Order by Stock Number

Standard Package 100 Screws

Stock No.	Size	Hex Head Across Flats	Stock No.	Size	Hex Head Across Flats
126-950	10 x 1	1/4	126-963	14 x 1-1/4	3/8
126-952	10 x 1-1/2	1/4	126-964	14 x 1-1/2	3/8
126-954	10 x 2	1/4	126-966	14 x 2	3/8
126-962	14 x 1	3/8			

papeo® ELEVATOR BOLTS
BOULONS D'ELEVATEUR

125
Series

UNC
Coarse
Thread

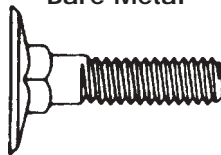

Bare Metal

Stress
Relieved

These flat countersunk head square neck Elevator Bolts have large diameter flush heads. Used on elevator buckets and industrial belting where low head clearance is needed. Also used extensively in truck and trailer applications for walls, floors, racks and trailer doors.

Order by Stock Number

Standard Package Contains 100 Bolts

Stock No.	Size	Stock No.	Size	Stock No.	Size
125-307	1/4 x 3/4	125-442	5/16 x 3/4		
125-309	1	125-444	1		
125-311	1-1/4	125-446	1-1/4	125-491	3/8 x 1-1/4
125-313	1-1/2	125-448	1-1/2	125-493	1-1/2
125-316	2	125-451	2	125-496	2
Head Dia.	1"	1-3/16"		1-5/16"	

Length measured overall.



255
Series

papeco® CLEVIS YOKES JOUGS DE CHAPE

DROP
FORGED
U N F
FINE THREAD

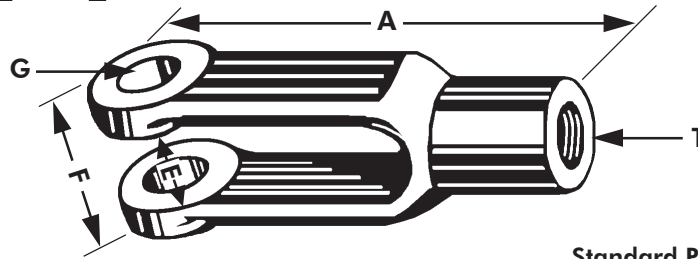

5 Sizes will
service all Cars
and Trucks.

Order by Stock Number

Standard Package 6 assemblies.

Stock No.	Size Chart					Used with S.A.E. Standard Pins	
	G	A	T	E	F	Clevis Pins	Cotter Pins
255-026	1/4	2	1/4	9/32	5/8	255-224	1/16 x 1/2
255-027	5/16	2-1/4	5/16	11/33	3/4	255-226	3/32 x 1/2
255-028	3/8	2-1/2	3/8	7/16	7/8	255-236	3/32 x 3/4
255-029	7/16	2-7/8	7/16	1/2	1	255-241	3/32 x 1
255-030	1/2	3	1/2	9/16	1	255-245	1/8 x 1

"Papeco" CLEVIS YOKES are supplied in five sizes to service all popular cars and trucks. A Yoke Assembly includes the Yoke, Clevis Pin and Cotter Pin. Standard Package consists of 6 Clevis Yoke Assemblies.

255
Series

papeco® UNIVERSAL CLEVIS PINS GOUPILES JOUG UNIVERSEL



Each diameter has multiple cotter pin holes to provide wide range of grip lengths. Reduces the number of pins required for emergency coverage for cars, trucks and farm implements.

Standard Package 6 pins.

UTILITY ASSORTMENT No. 020-329

Contains 24 Universal Clevis Pins in 6 popular sizes.

Packed in a sturdy fibre-board container.

Stock No.	Dia. x Length	Stock No.	Dia. x Length
255-044	1/4 x 2	255-084	1/2 x 2
255-054	5/16 x 2	255-086	1/2 x 3
255-064	3/8 x 2	255-106	5/8 x 3
255-074	7/16 x 2	255-126	3/4 x 3
255-076	1/2 x 3		



UNIVERSAL CLEVIS PINS GARAGE ASSORTMENT No. 020-061

Contains 5 each of 255-044, 054, 064 Universal Clevis Pins. Each size in an individual compartment in a rigid plastic box.



papeco® UNIVERSAL CLEVIS PINS GOUPILES JOUG UNIVERSEL

Convenient skin-packed card contains one Universal Clevis Pin and one Hitch Pin Clip.

Order by Stock Number

Card No.	Size	Hitch Pin Clip	Card No.	Size	Hitch Pin Clip
255-171	1/4 x 2	255-303	255-179	1/2 x 2	255-303
255-173	5/16 x 2	255-303	255-180	1/2 x 3	255-303
255-175	3/8 x 2	255-307	255-182	5/8 x 3	255-307
255-177	7/16 x 2	255-311	255-185	3/4 x 3	255-311
255-178	7/16 x 3	255-311			

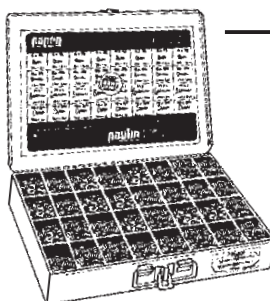
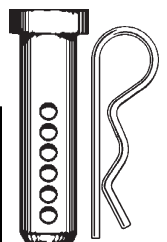

papeco SUPER SERVICE ASSORTMENT No. 020-816

Contains 173 Standard and Universal Clevis Pins and Clips — 40 items.
Large size, rigid metal box with high-strength plastic compartments.

For more details see page 9.

Large size: 12" w. x 18" l. x 3" d.

255
Series

papco CLEVIS PINS GOUPILES JOUG

Lengths shown are from under head to end of pin.



Order by Stock Number

Standard Package 25 pieces

Stock No.	Dia. x Length	Stock No.	Dia. x Length	Stock No.	Dia. x Length	Stock No.	Dia. x Length
255-221	3/16 x 5/8	255-228	5/16 x 1-1/4	* 255-236	3/8 x 1-3/32	255-244	7/16 x 1-3/4
* 255-224	1/4 x 51/64	255-208	5/16 x 1-1/2	255-237	3/8 x 1-1/4	255-251	1/2 x 1-1/4
255-225	1/4 x 1	255-230	5/16 x 1-9/16	255-238	3/8 x 1-3/8	* 255-245	1/2 x 1-27/64
255-203	5/16 x 3/4	255-231	5/16 x 1-3/4	255-239	3/8 x 1-1/2	255-246	1/2 x 1-1/2
* 255-226	5/16 x 31/32	255-213	3/8 x 7/8	* 255-241	7/16 x 1-15/64	255-248	1/2 x 2
255-205	5/16 x 1-1/8	255-235	3/8 x 1	255-242	7/16 x 1-1/2		

* Used with S.A.E. Standard Clevis Yokes.



CLEVIS PIN MASTER ASSORTMENT No. 020-641

This well-balanced assortment is packed in a sturdy, welded, metal box with moulded plastic compartments.

Each size of clevis pin is an individual compartment.

Complete specifications are shown on the grease-resistant lid label.

CLEVIS PINS GARAGE ASSORTMENT No. 020-062

Contains 41 Clevis Pins,
all popular sizes.



255
Series

papco HITCH PIN CLIPS AGRAFES POUR GOUIPILLE D'ATTELAGE

'Papco' Hitch Pin Clips are made of oil-tempered spring steel wire and are bright plated. Used on agricultural implements, lawn mowers, snowmobiles, construction and automotive equipment.

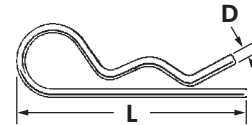

Order by Stock Number

Standard Package 25 pieces

Stock No.	Nom. Wire Diameter	Overall Length	Fit Shaft Diameters		I.D. of Eye
			Minimum	Maximum	
255-326	1/32	7/16	7/64	9/64	5/16
255-321	3/64	5/8	1/8	3/16	1/8
255-325	5/64	1-3/32	5/16	3/8	9/64
255-313	3/32	1-3/16	1/4	3/8	1/4
255-303	3/32	1-5/8	1/4	1/2	5/16
255-307	3/32	2-5/16	1/4	5/8	5/8
255-314	3/32	2-1/2	3/8	3/4	7/16
255-316	1/8	1-3/4	1/2	3/4	7/16
255-311	1/8	2-9/16	7/16	3/4	7/16
255-309	5/32	3-5/16	3/4	1-1/8	3/4
255-310	5/32	2-15/16	5/8	1"	3/4
255-306	3/16	3-1/4	5/8	1"	7/8
255-308	3/16	3-3/4	7/8	1-1/4	7/8
255-319	1/4	4-3/8	1"	1-1/2	3/4
255-320	5/16	3-15/16	1"	1-1/2	7/8

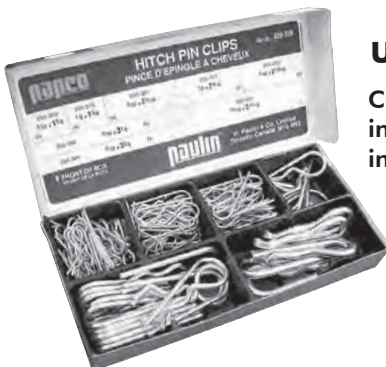

HITCH PIN CLIP UTILITY ASSORTMENT No. 020-338

Contains 105 Hitch Pin Clips, 8 sizes. Packed in a sturdy, fibre-board container with individual compartments.

HITCH PIN CLIP FARAGE ASSORTMENT No. 020-073

Contains 40 Hitch Pin Clips, 6 sizes. Packed in a clear plastic box.





165
C's
Hundreds

165
M's
Thousands

papco COTTER PINS
GOUPILES



BRIGHT ELECTRO-PLATED WITH CHROMATE FINISH

'Papco' Steel Cotter Pins are made in the extended prong style for easy insertion and locking. The length is measured under the head to the end of the shortest leg. Packaging is in Standard Packages of 100 pieces and in Packages of 1000* where indicated. All Cotter Pins are Bright Plated.

Order by Stock Number

Packages of 100 add prefix 165.

Packages of 1,000 add prefix 166.

Example of Stock Number 165-148 is 1/8 x 2 Steel Cotter Pins Plated in packages of 100.

Diameter	1/32	3/64	1/16	5/64	3/32	7/64	1/8	5/32	3/16	1/4	5/16	3/8
Length												
1/2	-019	-030	-043		-087		-137					
3/4		-032	-045*	-065	-089*		-139*					
1			-047*	-067	-091*	-115	-141*	-167*	-193*			
1-1/4			-049		-093		-143	-169	-195			
1-1/2			-051*		-095*	-119	-145*	-171*	-197*	-313*	-448*	
1-3/4			-053		-097		-147	-173				
2			-054		-098		-148*	-174*	-200*	-316*	-451*	-496
2-1/2					-100		-150	-176	-202	-318*	-453*	-498
3							-152	-178	-204	-320*	-455*	-500
3-1/2										-322	-457	-502
4										-324	-459	-504

COTTER PIN ASSORTMENT – No. 020-866

This Assortment consists of approximately 100 Cotter Pins in 1/16", 3/32", and 1/8" Diameters, and from 1/2" to 1-1/4" in lengths. Standard Package contains 24 individual assortments. All Bright Plated.



GARAGE ASSORTMENT – No. 020-033

Contains 340 Cotter Pins, seven sizes from 1/16" x 3/4" to 5/32" x 2". Packed in handy, clear plastic container. All Bright Plated.



UTILITY ASSORTMENT – No. 020-313

This Assortment of 1,000 Cotter Pins, in 10 popular sizes packed in individual compartments. Container is sturdy fibreboard with a hinged lid. All Bright Plated.

UTILITY ASSORTMENT – No. 020-343

This assortment contains 195 Large Size Cotter Pins - 9 sizes from 5/32" x 2" to 3/8" x 3". Packed in a sturdy fibreboard container each size in an individual compartment. Useful for Agricultural and Construction Equipment. All Bright Plated.



MASTER ASSORTMENT – No. 020-618

Contains 1230 Plated Cotter Pins, 20 sizes from 1/16" x 1/2" x 3/16" x 2". Packed in a metal, lidded box with moulded plastic compartments. Retail codes shown on lid label.

Size: 9-3/4" w.
x 13-3/4" l.
x 2" d.

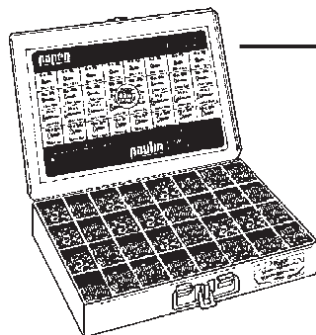

papco SUPER SERVICE ASSORTMENT No. 020-805

Contains 3345 Plated Cotter Pins and Throttle Rod Retainers - 32 items. Large size, rigid metal box with high-strength plastic compartments.

For more details see page 9.

Large size: 12" w. x 18" l. x 3" d.

167
Series

papco 'HAMMER-LOCK' COTTER PINS
GOUPILES 'HAMMER-LOCK'



BRIGHT ELECTRO-PLATED



These Cotter Pins spread automatically when hit with a hammer. The shorter shank rides over the up-turned point of the longer and locks rigidly. Twisting with a screwdriver returns pin to its original position. May also be used as standard cotter pins if desired.

Order by Stock Number

Standard Package 100 Pieces

Stock No.	Size Dia. x Length	Stock No.	Size Dia. x Length	Stock No.	Size Dia. x Length
167-045	1/16 x 3/4	167-091	3/32 x 1	167-148	1/8 x 2
167-047	1/16 x 1	167-095	3/32 x 1-1/2	167-171	5/32 x 1-1/2
167-051	1/16 x 1-1/2	167-141	1/8 x 1	167-174	5/32 x 2
167-089	3/32 x 3/4	167-145	1/8 x 1-1/2		

papco HAMMER-LOCK
COTTER PIN ASSORTMENT

UTILITY ASSORTMENT No. 020-314

Contains 800 Cotter Pins in the 10 popular sizes listed above. Each size is in an individual compartment in the sturdy fibreboard container. All Bright Plated.



168
Series

papco BRASS COTTER PINS
GOUPILES LAITON

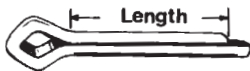

'Papco' BRASS Cotter Pins are used for marine applications, electrical and carburetor work.

Order by Stock Number

Standard Package 100 Pins

Stock No.	Size Dia. x Length	Stock No.	Size Dia. x Length
168-106	3/64 x 3/8	168-316	3/32 x 1
168-212	1/16 x 3/4	168-324	3/32 x 1-1/2
168-216	1/16 x 1	168-416	1/8 x 1
168-224	1/16 x 1-1/2	168-424	1/8 x 1-1/2
168-312	3/32 x 3/4	168-432	1/8 x 2

UTILITY ASSORTMENT No. 020-322

This assortment contains 500 Brass Cotter Pins, 50 each of 10 Stock Sizes. packed in individual compartments in sturdy metal-edge fibre board box.





141
Series

papeco UNI-RODS®

FULLY THREADED STEEL RODS

Continuous
Coarse Thread



Threaded
Full Length

These continuous threaded rods are made of cold drawn steel and are Zinc Plated or Bare Metal. Can be bent to shape without heating. Very useful in machine shops, garages, and for general maintenance. Used to make eye bolts, stud bolts, anchor bolts and for suspending equipment from ceilings, mountings on walls, etc. Just cut to length and use.

Order by Stock Number Tensile strength up to 5/8": 64,000 p.s.i. (min) 3/4" up: 55,000 p.s.i.(min)

Length	Inch Sizes							Metric Sizes				
	36"		12"		Std. Pkg.	36"		Std. Pkg.	Length Dia.	1 metre Plated	300mm Plated	Std. Pkg.
	Plated	Bare	Plated	Bare		Dia.	Plated					
1/4-20	141-314	141-354	141-204	25	5/8-11	141-324	141-364	5	M6	141-706	141-606	10
5/16-18	141-316	141-356	141-206	20	3/4-10	141-326	141-366	5	M8	141-708	141-608	10
3/8-16	141-318	141-358	141-208	15	7/8-9	141-328	141-368	3	M10	141-710	141-610	10
7/16-14	141-320	141-360	—	10	1"-8	141-330	141-370	3	M12	141-712	141-612	5
1/2-13	141-322	141-362	141-212	10								

Threaded Rods from 1/4-20 to 1-8 available in 6, 10 and 12 foot lengths.

For Stainless Steel Threaded Rods see page 164.

papecolloy B7 HIGH STRENGTH UNI-RODS®

B7 Alloy Rod

Gold Zinc Dichromate Plated

High strength continuous threaded rod to ASTM A-193 B7 Specification. Heat treated. Chrome-moly steel, tensile strength exceeds 125,000 p.s.i. Used for vehicles, construction, mining, chemical and petroleum equipment. Temperature service range from -150°F to +850°F. UNC coarse thread or UNF fine thread.

UNC Stock	UNF Stock	Size	Std. Pkg.	UNC Stock	UNF Stock	Size	Std. Pkg.	UNC Stock	UNF Stock	Size	Std. Pkg.
141-550	141-570	1/4 x 36	5	141-553	141-573	7/16 x 36	2	141-557	141-577	3/4 x 36	2
141-551	141-571	5/16 x 36	4	141-554	141-574	1/2 x 36	2	141-558	141-578	7/8 x 36	1
141-552	141-572	3/8 x 36	3	141-556	141-576	5/8 x 36	2	141-559	141-579	1" x 36	1



papeco HEX COUPLING NUTS

Plated Hexagon Steel Nuts for joining or adjusting Threaded Rods

Stock No.	Dia.	Dimensions	Std. Pkg.	Stock No.	Dia.	Dimensions	Std. Pkg.
141-914	1/4-20	7/16 x 7/8	50	141-924	5/8-11	15/16 x 2-1/8	15
141-916	5/16-18	1/2 x 1-3/4	25	141-926	3/4-10	1-1/8 x 2-1/4	15
141-918	3/8-16	9/16 x 1-3/4	25	141-928	7/8-9	1-1/4 x 2-1/2	10
141-920	7/16-14	5/8 x 1-3/4	25	141-930	1"-8	1-1/4 x 2-1/2	10
141-922	1/2-13	3/4 x 1-3/4	25	Dimensions: width across flats x length			

papeco UNI-BOLT® KITS

FULLY THREADED STEEL RODS, NUTS, WASHERS

Full threaded 'UNI-BOLTS' can be cut and shaped to make any length or style of bolt. Each kit contains plated parts for two complete bolts - lock washers, flat washers and hex nuts. Available in four coarse thread inch diameters and four metric diameters 12 inches (300mm) long.

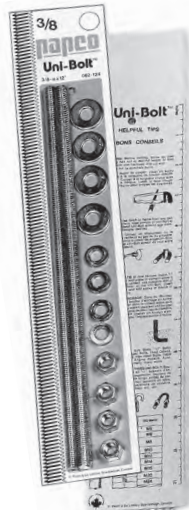

Card No.	Size	Card No.	Size
141-104	1/4-20 x 12"	141-154	M6 x 300mm
141-114	5/16-18 x 12"	141-164	M8 x 300mm
141-124	3/8-16 x 12"	141-174	M10 x 300mm
141-134	1/2-13 x 12"	141-184	M12 x 300mm



**BASIC STOCK FOR AUTOMOTIVE,
INDUSTRIAL, FARM AND HARDWARE**

This sturdy merchandiser holds 16 sizes of bare metal construction grade steel. Contains the right selection of flats, round and angles needed in daily repairs. Steel can be cut, bent, drilled and welded as required. All items handy 36" length.

- Wide range of steel for general repairs.
- Sturdy, all-metal floor stand.
- Retail price labelled.
- Can hold parts bins for fasteners, etc.
- Size 24-1/2"w. x 13-1/2"d. x 24"h.
- Shipping weight with stock 100 pounds.
- Contains 52 steel shapes - one standard package of each size.

Merchandiser No. 022-008
(For empty Steel Centre Floor
Stand order No. 022-014)

BARE METAL STEEL and ALUMINUM RODS and SHAPES

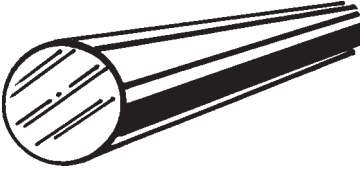
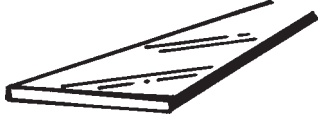
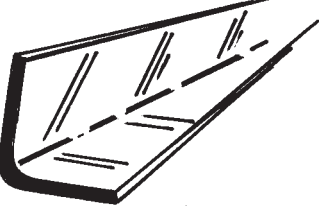
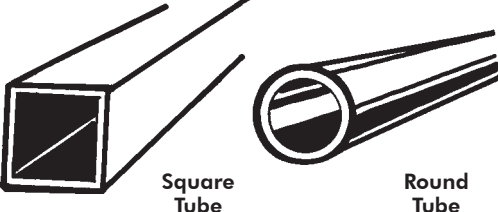
Stock No.	Size	Std. Pkg.	Wt. Ea.*	Part No.	Size	Std. Pkg.	Wt. Ea.*	Stock No.	Size	Std. Pkg.	Wt. Ea.*	Part No.	Size	Std. Pkg.	Wt. Ea.*
36" LONG								36" LONG							
															
STEEL ROUNDS				ALUMINUM ROUNDS				STEEL FLATS				ALUMINUM FLATS			
142-004	1/4 dia.	5	.5	142-808	3/8 dia.	5	.4	142-040	1/8x3/4	3	1.0	142-640	1/8x3/4	3	0.3
142-006	5/16 dia.	5	.8	142-812	1/2 dia.	5	.7	142-042	1/8x1	3	1.2	142-642	1/8x1	3	0.4
142-008	3/8 dia.	5	1.1	142-814	5/8 dia.	3	1.1	142-044	1/8x1-1/4	3	1.6	142-646	1/8x1-1/2	3	0.6
142-012	1/2 dia.	5	2.0					142-046	1/8x1-1/2	3	2.0	142-648	1/8x2	3	0.9
36" LONG								36" LONG							
															
STEEL ANGLES				ALUMINUM ANGLES				STEEL TUBING				ALUMINUM TUBING			
142-100	1/8x3/4	3	1.8	142-700	1/8x3/4	3	.6	142-302	3/4 Sq.	2	1.7	142-430	3/4 Sq.	3	0.5
142-102	1/8x1	3	2.4	142-702	1/8x1	3	.8	142-304	1" Sq.	2	3.9	142-432	1" Sq.	3	0.6
142-104	1/8x1-1/4	3	3.0	142-706	1/8x1-1/2	3	1.2	142-402	3/4 Rd.	2	1.3	142-338	3/4 Rd.	3	0.4
142-106	1/8x1-1/2	3	3.7	142-708	1/8x2	3	1.6	142-404	1" Rd.	2	3.1	142-340	1" Rd.	3	0.5

Included in Steel Centre Merchandiser No. 022-008

Note: 3/4 Steel Tubing wall = .065, 1" = .100
3/4 and 1" Aluminum Tubing wall = .050

* lbs.



papeco[®] METAL CENTRE PLUS

MERCHANDISER No. 022-007

CENTRE DU MÉTAL PLUS PRÉSENTOIR No. 022-007



MASTER STOCK OF CONSTRUCTION
GRADE STEEL FOR AUTOMOTIVE,
INDUSTRIAL, FARM, HARDWARE
AND HOME

Cold rolled steel sheets, galvanized steel,
aluminum sheets and expanded metal.

Contains the right selection of flats, rounds
and angles (see Merchandiser No. 022-
008), plus sheets needed in daily repairs
(see below).

Can be cut, bent, formed, drilled and
welded as required.

- Wide range of metal for general repairs.
- Sturdy all-metal floor stand.
- Retail price labelled.
- Can hold parts bins for related fasteners.
- New graphic label channel and protector guard bar - a safe retail unit.
- Shipping weight with stock 125 pounds.
- Contains 55 Steel shapes - one package of each size PLUS 12 metal sheets.

Size: 24-1/2" w. x 13-1/2" d. x 24" h.

papeco[®] SHEET STEEL

FEUILLES DE TÔLE

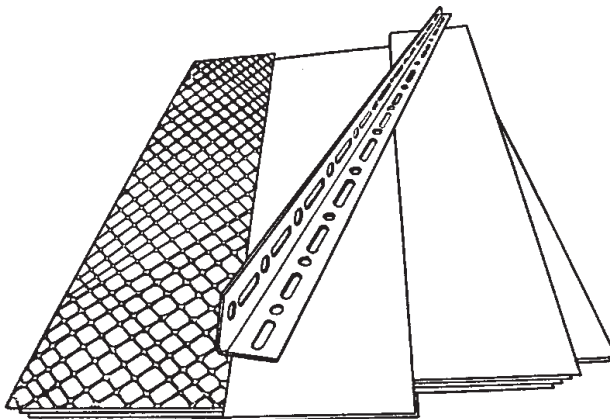

Part No.	Size	Description	Std. Pkg.	Wt. lbs.
142-524	8" x 24"	22ga. C.R. Steel Sheet	2	1.7
142-528	12" x 24"	22ga. C.R. Steel Sheet	2	2.5
142-495	12" x 24"	26ga. Galvanized Sheet	2	1.8
142-551	12" x 24"	.025 Aluminum Sheet	2	0.7
142-558	12" x 24"	1/2" Expanded Metal	2	2.9
142-568	12" x 24"	3/4" Expanded Metal	2	1.7
142-200*	1-1/2" x 36"	.074 Slotted Angles	3	2.1
142-202	1-1/2" x 48"	.074 Slotted Angles - Galv.	3	4.8
142-204	1-1/2" x 72"	.074 Slotted Angles - Galv.	3	7.8
142-220	1-3/8" x 36"	.074 Slotted Flats - Galv.	3	2.4
142-222	1-3/8" x 48"	.074 Slotted Flats - Galv.	3	3.6

WARNING: DO NOT Weld Galvanized metal as toxic fumes may be present.

C.R. = Cold Rolled

papeo® UNI-ROD® MERCHANDISERS PRESENTOIRS UNI-ROD®



Feature a heavy-duty, labelled steel floor stand to display and sell threaded rods, coupling nuts, washers, etc.



No. 022-010 PLATED UNI-RODS, COUPLING NUTS			
Metal Merchandiser with Six Service Bins			
36" THREADED RODS		COUPLING NUTS	
25 1/4" Rods	10 1/2" Rods	50 1/4 Nuts	25 1/2 Nuts
20 5/16"	5 5/8"	25 5/16	15 5/8
15 3/8"	5 3/4"	25 3/8	15 3/4

No. 022-011 PLATED UNI-RODS	
With Metal Merchandiser	
25 1/4 x 36 Plated Rods	10 1/2 x 36 Plated Rods
20 5/16	5 5/8
15 3/8	5 3/4

No. 022-012 BARE METAL UNI-RODS	
With Metal Merchandiser	
25 1/4 x 36 Bare Rods	10 1/2 x 36 Bare Rods
20 5/16	5 5/8
15 3/8	5 3/4

(For empty Threaded Rod Floor Stand order 022-014 Bins NOT included. For plastic Bins No. 022-040 see page 13.)

Merchandiser No. 022-010
Size: 24-1/2" w. x 13-1/2" d. x 24" h.

No. 022-013 PLATED THREADED RODS, NUTS, WASHERS, COUPLING NUTS			
Deluxe Display with Metal Merchandiser and 18 Service bins. Complete Coverage.			
Threaded Rods	Finished Nuts	S.A.E. Washers	Coupling Nuts
25 1/4" 141-314	200 1/4" 083-014	200 1/4 154-014	50 1/4" 141-914
20 5/16" 141-316	200 5/16" 083-016	200 5/16 154-016	25 5/16" 141-916
15 3/8" 141-318	200 3/8" 083-018	200 3/8 154-018	25 3/8" 141-918
10 1/2" 141-322	100 1/2" 083-022	200 1/2 154-022	25 1/2" 141-922
5 5/8" 141-324	50 5/8" 083-024	100 5/8 154-024	15 5/8" 141-924
5 3/4" 141-326	50 3/4" 083-026	100 3/4 154-026	15 3/4" 141-926

PLATED THREADED ROD ASSORTMENT No. 020-900

Contains 10 lengths of continuous Threaded Rod, 30 feet altogether.

Two lengths each of 1/4", 5/16", 3/8", 7/16", and 1/2" diameter.

With this handy assortment you can make up those extra long bolts quickly and easily.

Save time—no thread cutting required. Save money—no delays and no need to carry large bolt stocks.

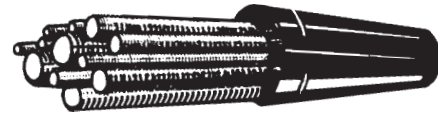

12 INCH UNI-ROD DISPLAY No. 020-903

This assortment contains 50 lengths: 10 each of 1/4, 5/16, 1/2 and 20 lengths of 3/8 x 12" fully threaded steel rods. All bright plated to resist rust. Attractive all-metal merchandiser can stand on counter or hang on wall.



Metal Display Size: 11" w. x 3" d. x 11" h.

METRIC UNI-ROD DISPLAY No. 020-904

This assortment contains 50 lengths: 10 each of M5, M10, M12 and 20 lengths of M8 x 300mm fully threaded steel rods blue plated. All-metal merchandiser can stand on counter or hang on wall.



papeco® PLAIN STEEL WASHERS RONDELLES ORDINAIRES



(U.S.S. Wrought Washers)

papeco FLAT WASHERS are free from burrs and have smooth, flat surfaces.



143
1 lb. Bare

144
5 lbs. Bare

145
100's Bare

146
1 lb. Plated

148
100's Plated

Order by Stock Number

Standard Packages as indicated

Stock No.'s					100's Std. Pkg.	Bolt Size	Hole Size	Outside Dia.	Thickness	Approx. No. per lb.
1 lb. Bare (454 g)	5 lbs. Bare (2.2 kg)	100's Bare	1 lb Plated (454 g)	100's Plated						
143-010	144-010	145-010	146-010	148-010	100	3/16	1/4	9/16	3/64	294
143-014	144-014	145-014	146-014	148-014	100	1/4	5/16	3/4	1/16	162
143-016	144-016	145-016	146-016	148-016	100	5/16	3/8	7/8	1/16	96
143-018	144-018	145-018	146-018	148-018	100	3/8	7/16	1	5/64	75
143-020	144-020	145-020	146-020	148-020	50	7/16	1/2	1-1/4	3/32	38
143-022	144-022	145-022	146-022	148-022	50	1/2	9/16	1-3/8	7/64	27
143-023	144-023	145-023	146-023	148-023	25	9/16	5/8	1-1/2	7/64	23
143-024	144-024	145-024	146-024	148-024	25	5/8	11/16	1-3/4	9/64	13
143-026	144-026	145-026	146-026	148-026	20	3/4	13/16	2	9/64	9
143-028	144-028	145-028	146-028	148-028	20	7/8	15/16	2-1/4	5/32	7
143-030	144-030	145-030	146-030	148-030	20	1	1-1/16	2-1/2	5/32	6
	144-032					1-1/8	1-3/16	2-3/4	5/32	5
	144-034					1-1/4	1-5/16	2-3/4	5/32	5
	144-037					1-1/2	1-9/16	3-1/4	11/64	3



PLAIN STEEL WASHER UTILITY ASSORTMENT

No. 020-352

Contains 5.5 lbs of Plain Steel Washers in bolt sizes from 3/16" to 5/8". Each size in an individual compartment. Packed in a sturdy fibre-board container. All Brigh Plated.

PLAIN STEEL WASHER MASTER ASSORTMENT No. 020-620

Contains over 1615 Plain Steel Washers 10 sizes from 1/8" to 3/4". packed in a metal divided box with hinged lid, carrying handle, positive lock and illustrated label showing retail price codes. All Brigh Plated.



For 'Super-Service' Assortment No. 020-804 of Plain Steel, S.A.E. and Lock Washers see page 56.

papeo® S.A.E. WASHERS RONDELLES S.A.E.



papeo S.A.E. Steel Washers are made from Strip Steel; have bright, smooth, flat surfaces; are highly polished and are free from burrs.

149
1 lb.
Bare

151
100's
Bare

154
100's
Plated

Order by Stock Number

**BRIGHT
PLATED**

Standard Packages as indicated

Stock No.'s			100's Std. Pkg.	Bolt Size	Inside Dia.	Outside Dia.	Thickness	Approx. No. per lb.
1 lb. Bare (454 g)	100's Bare	100's Plated						
		154-002	100	#2	3/32	1/4	1/32	2500
		154-004	100	#4	1/8	5/16	1/32	1650
		154-006	100	#6 (1/8)	5/32	3/8	3/64	800
149-008		154-008	100	#8	3/16	7/16	3/64	550
149-010	151-010	154-010	100	#10 (3/16)	7/32	1/2	1/16	350
149-014	151-014	154-014	100	1/4	9/32	5/8	1/16	225
149-016	151-016	154-016	100	5/16	11/32	11/16	1/16	200
149-018	151-018	154-018	100	3/8	13/32	13/16	1/16	140
149-020	151-020	154-020	50	7/16	15/32	59/64	1/16	105
149-022	151-022	154-022	50	1/2	17/32	1-1/16	3/32	55
149-023	151-023	154-023	25	9/16	19/32	1-3/16	3/32	45
149-024	151-024	154-024	25	5/8	21/32	1-5/16	3/32	36
149-026	151-026	154-026	20	3/4	13/16	1-1/2	1/8	22
149-028	151-028	154-028	20	7/8	15/16	1-3/4	1/8	16
149-030	151-030	154-030	20	1	1-1/16	2	1/8	12



SMALL SIZE S.A.E. WASHER GARAGE ASSORTMENT No. 020-031

Contains 400 pieces, 6 sizes no. 2 to 1/4" dia. For Electrical, Radio and Electronic use. Packed in a transparent plastic box.



PLATED S.A.E. WASHER UTILITY ASSORTMENT No. 020-341

Contains 370 S.A.E. Standard Steel Washers in sizes from 3/16" to 5/8". Each size is in an individual compartment in a sturdy fibreboard container.



PLATED S.A.E. WASHER MASTER ASSORTMENT No. 020-619

Contains 1200 S.A.E. Washers, 12 sizes from 1/8" to 1". Packed in a metal, divided box with hinged lid, carrying handle, positive lock and illustrated lid label showing retail price codes.

Size: 9-3/4" w. x 13-3/4" l. x 2" d.

For 'Super-Service' Assortment No. 020-804 of Plain Steel, S.A.E. and Lock Washers see page 56.



Papco® SPRING LOCK WASHERS RONDELLES RESORT

High Carbon Spring Steel - Plain Type - Non-Linking

REGULAR LOCK WASHERS



155 100's Bare	156 1000's Bare	157 100's Plated
-----------------------------	------------------------------	-------------------------------

'Papco' Lock Washers provide a locking spring action against the tendency of threaded assemblies loosening due to vibration. They are made to specifications of the Society of Automotive Engineers (S.A.E.) and the current ANSI B27.1 standard. They are supplied in Regular, for Grade 2 bolts and low load applications; Papcolloy (Extra Duty) for Grade 5, 8 or 9 bolts and high load applications; and Hi-Collar for Socket Head Cap Screws.

Standard Packages: 100's - up to 1" - 100; 1-1/8 - 1-1/4 - 50; 1-1/2 - 25.

Order by Stock Number

1000's - up to - 7/16 - 1000; 1/2 to 5/8 - 500; 3/4 - 250.

Stock No.			Bolt Size	Steel Section W x T	Stock No.			Bolt Size	Steel Section W x T
100's Bare	1000's Bare	100's Plated			100's Bare	1000's Bare	100's Plated		
155-006	156-006		#6 (1/8)	.047 x .031	155-023	156-023	157-023	9/16	.188 x .141
155-008	156-008		#8 (5/32)	.055 x .040	155-024	156-024	157-024	5/8	.203 x .156
155-010	156-010	157-010	#10 (3/16)	.062 x .047	155-026	156-026	157-026	3/4	.234 x .188
155-012	156-012	157-012	#12 (7/32)	.070 x .056	155-028		157-028	7/8	.266 x .219
155-014	156-014	157-014	1/4	.109 x .062	155-030		157-030	1"	.297 x .250
155-016	156-016	157-016	5/16	.125 x .078	155-032			1-1/8	.328 x .281
155-018	156-018	157-018	3/8	.141 x .094	155-034			1-1/4	.359 x .312
155-020	156-020	157-020	7/16	.156 x .109	155-036			1-3/8	.391 x .344
155-022	156-022	157-022	1/2	.171 x .125	155-038			1-1/2	.422 x .375

101
Series

PAPCOLLOY LOCK WASHERS

Extra Duty

4037 HIGH ALLOY STEEL

For use with Grade 5, 8 or 9 bolts and for high load applications.
Mechanical Gold Zinc Dichromate Plated.

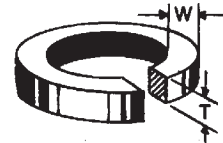

Order by Stock Number

Stock No.	Bolt Size	Std. Pkg.	Steel Section W x T	Stock No.	Bolt Size	Std. Pkg.	Steel Section W x T
101-014	1/4	100	.109 x .062	101-026	3/4	40	.234 x .188
101-016	5/16	100	.125 x .078	101-028	7/8	40	.266 x .219
101-018	3/8	100	.141 x .094	101-030	1"	40	.297 x .250
101-020	7/16	100	.156 x .109	101-032	1-1/8	20	.411 x .375
101-022	1/2	50	.171 x .125	101-034	1-1/4	20	.452 x .417
101-023	9/16	50	.188 x .141	101-038	1-1/2	20	.526 x .496
101-024	5/8	50	.203 x .156				

159
Series

HI-COLLAR LOCK WASHERS

HIGH CARBON SPRING STEEL

For use with Socket Head Cap Screws.

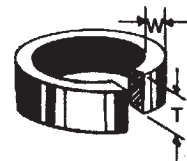

Order by Stock Number

Stock No.	Bolt Size	Std. Pkg.	Steel Section W x T	Stock No.	Bolt Size	Std. Pkg.	Steel Section W x T
159-014	1/4	100	.047 x .078	159-020	7/16	100	.090 x .140
159-016	5/16	100	.062 x .093	159-022	1/2	50	.103 x .172
159-018	3/8	100	.076 x .125	159-024	5/8	50	.125 x .203

papeo® SPRING LOCK WASHER ASSORTMENTS ASSORTIMENTS DE RONDELLES RESSORT



LOCK WASHER GARAGE ASSORTMENT No. 020-047

Contains 235 Regular Lock Washers Plated in sizes 3/16" to 1/2". Packed in a transparent plastic box.

LOCK WASHER ASSORTMENT No. 020-886

This popular Assortment contains 39 Lock Washers in sizes 3/16" to 1/2". Standard package contains 24 individual assortments. All Bright Plated.



LOCK WASHER UTILITY ASSORTMENT No. 020-339

This Assortment contains 505 Regular Lock Washers Plated in nine sizes from 3/16" to 3/4". Packed in a sturdy, fibreboard container with moulded compartments.

LOCK WASHER MASTER ASSORTMENT No. 020-621

Contains 1257 Regular Lock Washers Plated in twelve sizes from 1/8" to 1". Packed in a metal box with moulded plastic compartments. Hinged lid, positive lock carrying handle and illustrated lid label that shows retail price codes.



Size: 9-3/4" w. x 13-3/4" l. x 2" d.

papeo SUPER SERVICE ASSORTMENT No. 020-804



PLAIN STEEL, S.A.E. and LOCK WASHER SUPER-SERVICE ASSORTMENT No. 020-804

Contains 3020 Flat, Lock and Tooth Lock Washers in thirty two sizes. Large size metal box with high strength moulded plastic compartments. For more details see page 9. All Bright Plated.

Size: 12" w. x 18" l. x 3" d.



161
Series



TOOTH LOCK WASHERS RONDELLES ANTI-VIBRATION

Bright Zinc Plated
High Carbon Spring Steel



EXTERNAL TYPE



COUNTERSUNK TYPE



INTERNAL TYPE

Order by Stock Number

Standard Packages 100 Pieces.

EXTERNAL TYPE				COUNTERSUNK TYPE				INTERNAL TYPE			
Stock No.	Bolt or Screw Size	Outside Diameter	Thickness	Stock No.	Bolt or Screw Size	Outside Diameter	Thickness	Stock No.	Bolt or Screw Size	Outside Diameter	Thickness
161-106	6 (1/8)	5/16	.018	161-306	6 (1/8)	19/64	.018	161-206	6 (1/8)	9/32	.018
161-108	8 (5/32)	3/8	.020	161-308	8 (5/32)	11/32	.018	161-208	8 (5/32)	21/64	.020
161-110	10 (3/16)	13/32	.022	161-310	10 (3/16)	3/8	.022	161-210	10 (3/16)	3/8	.022
161-114	1/4	1/2	.025	161-314	1/4	15/32	.022	161-214	1/4	15/32	.025
161-118	5/16	19/32	.030	161-318	5/16	5/8	.025	161-218	5/16	19/32	.030
161-120	3/8	11/16	.035	161-320	3/8	25/32	.030	161-220	3/8	11/16	.035
161-122	7/16	25/32	.035					161-222	7/16	25/32	.035
161-124	1/2	7/8	.040					161-224	1/2	7/8	.040
161-126	9/16	31/32	.040					161-226	9/16	31/32	.040
161-128	5/8	1-1/16	.045					161-228	5/8	1-1/16	.045
161-132	3/4	1-1/4	.050					161-232	3/4	1-1/4	.050
161-134	7/8	1-7/16	.055					161-234	7/8	1-3/8	.055
161-136	1"	1-5/8	.062					161-236	1"	1-5/8	.062
				EXTERNAL COUNTERSUNK							

PLATED TOOTH LOCK WASHER

GARAGE ASSORTMENT No. 020-034 INTERNAL TYPE

Contains 225 Internal Type
Tooth Lock Washers
in six sizes from 3/16" x 1/2"



PLATED TOOTH LOCK WASHER

GARAGE ASSORTMENT No. 020-035 EXTERNAL TYPE

Contains 225 External Type
Tooth Lock Washers
in six sizes from 3/16" x 1/2"



PLATED TOOTH LOCK WASHER

MASTER ASSORTMENT No. 020-625

Contains 1370 Internal and External Washers.
10 external sizes from #6 to 3/4"; 10 internal sizes
from #6 to 3/4". Packed in a metal container with
hinged lid, carrying handle and lock.

PLATED TOOTH LOCK WASHER

UTILITY ASSORTMENT No. 020-340

Contains 900 Internal and External Tooth Lock
Washers 16 sizes from #6 to 1/2" in both types.

Packed in a sturdy fibreboard container.



162
Series

papco FIBRE WASHERS
RONDELLES FIBRE

1/32" – Two Thicknesses – 1/16"

"Papco" FIBRE WASHERS are made from vulcanized fibre. They are suitable for generator, carburetor or fuel pump work and wherever an insulating washer or gasket is required.

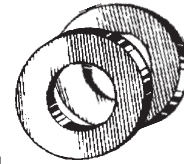

Order by Stock Number

Standard Packages 100 Pieces.

Stock Nos.		Inside Dia.	Out-side Dia.	Stock Nos.		Inside Dia.	Out-side Dia.	Stock Nos.		Inside Dia.	Out-side Dia.	Stock Nos.		Inside Dia.	Out-side Dia.
1/32 Thick	1/16 Thick			1/32 Thick	1/16 Thick			1/32 Thick	1/16 Thick			1/32 Thick	1/16 Thick		
162-201	162-251	3/32	3/16	162-207	162-257	1/4	3/8	162-213	162-263	1/2	5/8	162-220	162-270	11/16	15/16
162-202	162-252	3/32	1/4	162-208	162-258	5/16	7/16	162-214	162-264	7/16	11/16	162-221	162-271	3/4	1"
162-203	162-253	1/8	1/4	162-209	162-259	1/4	1/2	162-215	162-265	1/2	3/4	162-223	162-273	3/4	1-1/16
162-204	162-254	1/8	5/16	162-210	162-260	3/8	1/2	162-216	162-266	5/8	3/4	162-224	162-274	13/16	1-1/8
162-205	162-255	3/16	5/16	162-211	162-261	5/16	9/16	162-218	162-268	9/16	13/16	162-225	162-275	15/16	1-1/4
162-206	162-256	3/16	3/8	162-212	162-262	3/8	5/8	162-219	162-269	5/8	7/8	162-226	162-276	7/8	1-3/16
												162-227	162-277	1	1-5/16

For Fibre Drain Plug Gaskets see page 129.



FIBRE WASHER ASSORTMENT No. 020-857

- Contains 360 Fibre Washers.
- 18 Sizes 1/16 and 1/32 thick
162-203, 206, 209, 211, 212, 214, 215, 219, 221
162-253, 256, 259, 261, 262, 264, 265, 269, 271.
- Plastic container with moulded compartments.
- Illustrated label shows sizes etc.
- Refills available in standard packages.

FIBRE WASHER GARAGE ASSORTMENT No. 020-059

This Assortment contains 130 Fibre Washers in sizes from 1/8" to 3/4".

Packed in clear, plastic box with hinged lid.



162
Series

papco FLAT FENDER WASHERS
RONDELLES AILE

BRIGHT PLATED

Used for Fender and Body work. Also two washers can be bolted together and used for Heater Hose Hole plugs.

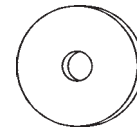

Order by Stock Number

Standard Packages 100 Pieces.

Stock No.	Bolt Size	Outside Dia.	Inside Dia.	Thickness	Stock No.	Bolt Size	Outside Dia.	Inside Dia.	Thickness
162-393	3/16	1"	13/64	3/64	162-397	5/16	1-1/4	11/32	1/16
162-394	3/16	3/4	13/64	3/64	162-398	3/8	1-1/2	13/32	1/16
162-395	1/4	1-1/4	9/32	1/16	162-399	5/16	1-1/2	11/32	1/16
162-396	5/16	1"	11/32	1/16	162-400	1/2	2"	17/32	1/16



FENDER WASHER GARAGE ASSORTMENT No. 020-057

Contains 71 Bright Plated Fender Washers for 3/16", 1/4", 5/16" and 3/8 Bolts.

Packed in rigid, transparent plastic container.



162
Series

papeco MACHINERY BUSHINGS
BAGUES DE MACHINERIE

These steel repair bushings are used on Agricultural Machinery, Road Machines, Mine and Mill Equipment, Automobiles, Trucks, etc.

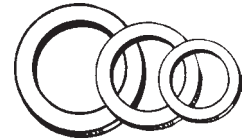

Order by Stock Number

Standard Package 25 pieces

Stock No.	Shaft Dia.	Outside Dia.	Gauge	Weight per 100 pcs.	Stock No.	Shaft Dia.	Outside Dia.	Gauge	Weight per 100 pcs.
162-610	5/8	1-1/8	18	0.9	162-626	1-1/4	1-7/8	14	3.4
162-611			14	1.5	162-627			10	6.1
162-613	3/4	1-1/4	18	1.0	162-631	1-3/8	2-1/8	18	2.7
162-614			14	1.7	163-632			14	4.6
162-615			10	3.1	162-633			10	8.2
162-616	7/8	1-3/8	18	1.2	162-635	1-1/2	2-1/4	14	4.8
162-617			14	2.0	162-636			10	8.6
162-619	1"	1-1/2	18	1.3	162-640	1-3/4	2-1/2	18	3.3
162-620			14	2.2	162-641			14	5.6
162-621			10	4.0	162-642			10	10.0
162-622	1-1/8	1-3/4	18	1.9	162-650	1-7/8	2-7/8	14	8.3
162-623			14	3.1	162-653	2	3	14	8.6
162-624			10	5.6	162-654			10	15.0
162-625	1-1/4	1-7/8	18	2.0	162-657	2-1/8	3-1/8	10	16.3

18Ga.=.050"; 14Ga.=.083"; 10Ga.=.134"

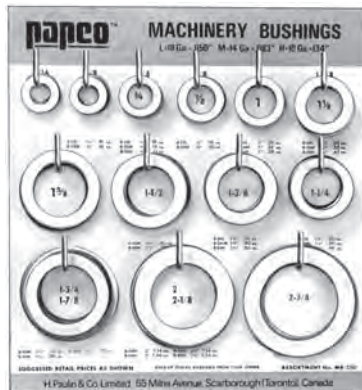

**MACHINERY BUSHING
ASSORTMENT No. 020-875**

This assortment is made up of 174 Machinery Bushings selected by popularity. Twenty eight sizes for complete coverage. The 020-875 Assortment includes a 3-colour display board and 13 screw hooks. Ideal for Implement and Machinery dealers.

162
Series

papeco RAPID REPAIR WASHERS
RONDELLES REPARATION RAPIDE

(STEEL OVERLATCH WASHERS)

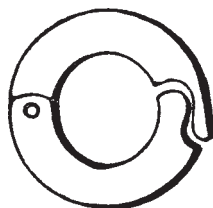

OPEN

These split bushings are applied by slipping the open washer over the shaft and tapping the overlatch in place. Save valuable time and expense by removing excess end play in shafts without dismantling the equipment. Use on farm machinery - harvesters, combines, binders - road machinery and construction equipment.

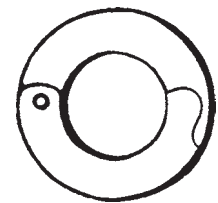

CLOSE

Order by Stock Number

Standard Package Contains 10 Washers.

Stock No.	Shaft Dia.	Outside Dia.	Gauge	Weight per 100 pcs.	Stock No.	Shaft Dia.	Outside Dia.	Gauge	Weight per 100 pcs.
162-712	3/4	1-3/4	1/8	7	162-722	1-3/8	2-3/8	1/8	10.5
162-714	7/8	1-7/8	1/8	8	162-724	1-1/2	2-1/2	1/8	11
162-716	1	2	1/8	8.5	162-728	1-3/4	2-3/4	1/8	12.5
162-718	1-1/8	2-1/8	1/8	9	162-732	2	3	1/8	14
162-720	1-1/4	2-1/4	1/8	10					

162 Series

**papco® RAPID REPAIR WASHERS
RONDELLES REPARATION RAPIDE**



Convenient skin-packed card includes two (2) Rapid Repair Washers. Order by Card Number



Card No.	Shaft Dia.	Card No.	Shaft Dia.
162-762	3/4	162-772	1-3/8
162-764	7/8	162-774	1-1/2
162-766	1"	162-778	1-3/4
162-768	1-1/8	162-782	2"
162-770	1-1/4		



RAPID REPAIR WASHER ASSORTMENT No. 020-876

Includes 9 sizes of carded Rapid Repair Washers in sizes 3/4" to 2" — 30 cards in all, plus peg-board hooks and attractive three-colour point of purchase signs.

Card No. 162-766

162 Series

**papco® BRASS WASHERS
RONDELLES LAITON**

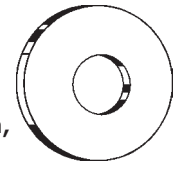

"PAPCO" BRASS WASHERS are free from burrs and have bright, smooth, flat surfaces.

Small or large patterns available from No. 6 to 3/8".

Order by Stock Number

Stock No.	Screw or Bolt Size	I.D.	O.D.	Thick.	Std. Pkg.	Stock No.	Screw or Bolt Size	I.D.	O.D.	Thick.	Std. Pkg.
162-802	#2	.092	7/32	.018	100	162-815	1/4	.260	11/16	.051	100
162-803	#3	.105	1/4	.020	100	162-816	5/16	.337	3/4	.064	100
162-804	#4	.119	9/32	.025	100	162-817	5/16	.337	7/8	.064	100
162-805	#5	.133	9/32	.025	100	162-818	3/8	.391	7/8	.064	100
162-806	#6	.147	5/16	.028	100	162-819	3/8	.391	1	.081	100
162-807	#6	.147	3/8	.032	100	162-820	7/16	1/2	1-1/8	.081	50
162-808	#8	.172	3/8	.032	100	162-822	1/2	9/16	1-1/4	.091	50
162-809	#8	.172	7/16	.036	100	162-823	9/16	5/8	1-1/2	.091	25
162-810	#10	.200	7/16	.036	100	162-824	5/8	11/16	1-1/2	.102	25
162-811	#10	.200	1/2	.040	100	162-826	3/4	13/16	1-7/8	.114	20
162-812	#12	.227	1/2	.040	100	162-828	7/8	15/16	2-1/4	.128	20
162-813	#12	.227	9/16	.040	100	162-830	1	1-1/16	2-1/2	.144	20
162-814	1/4	.260	9/16	.040	100						

BRASS WASHER GARAGE ASSORTMENT No. 020-056

Contains 100 Brass Washers in popular sizes from No. 10 to 1/2". Packed in a clear plastic box with hinged lid.



COPPER WASHER GARAGE ASSORTMENT No. 020-083

Contains 100 Copper Washers in six sizes from No. 10 to 1/2". Packed in a transparent plastic box with hinged lid.

162 Series

**papco® COPPER WASHERS
RONDELLES CUIVRE**



"PAPCO" soft Copper Washers are used as gaskets and have bright, smooth, flat surfaces.

Order by Stock Number

Stock No.	Bolt Size	I.D.	O.D.	Thick.	Std. Pkg.	Stock No.	Bolt Size	I.D.	O.D.	Thick.	Std. Pkg.
162-860	#10	7/32	1/2	1/16	100	162-868	3/8	13/32	13/16	1/16	100
162-864	1/4	9/32	5/8	1/16	100	162-870	7/16	15/32	59/64	1/16	50
162-866	5/16	11/32	11/16	1/16	100	162-872	1/2	17/32	1-1/16	3/32	50

For Copper Drain Plug Gaskets see page 129.



162
Series

papco **RAPID REPAIR WASHERS**
RONDELLES REPARATION RAPIDE



'Papco' Steel Spacer Washers are made from Cold Rolled Steel. All Spacer Washers are 1/32" thick.

Order by Stock Number

Stock No.	Hole Size	O.D.	Std. Pckg.	Stock No.	Hole Size	O.D.	Std. Pckg.	Stock No.	Hole Size	O.D.	Std. Pckg.
162-910	3/16	1/2	100	162-925	11/16	1-1/16	100	162-936	1-3/8	2"	50
162-914	1/4	9/16	100	162-926	3/4	1-1/8	100	162-938	1-1/2	2-1/4	50
162-916	5/16	5/8	100	162-927	13/16	1-1/4	100	162-940	1-5/8	2-3/8	25
162-918	3/8	3/4	100	162-928	7/8	1-3/8	100	162-942	1-3/4	2-1/2	25
162-920	7/16	13/16	100	162-930	1"	1-1/2	50	162-944	2	2-3/4	25
162-922	1/2	7/8	100	162-932	1-1/8	1-5/8	50	162-946	2-1/8	3"	25
162-923	9/16	1"	100	162-934	1-1/4	1-7/8	50	162-948	2-1/4	3-1/4	25
162-924	5/8	1"	100								

SPACER WASHER

GARAGE ASSORTMENT No. 020-058

Contains 125 Steel Spacer Washers all 1/32" thick in sizes from 1/4" to 1-1/2". Packed in a transparent, plastic box.



papco **SPRING TENSION WASHERS**

These heat treated spring steel washers are used to eliminate rattles in rods and connecting levers and to take up side play and lost motion in carburetor linkage, clevis yokes, brake shoe pins and gear shift rods etc.



Order by Stock Number

Stock No.	Shaft Dia.
162-963	3/16
162-964	1/4
162-965	5/16
162-966	3/8
162-967	7/16
162-968	1/2

SPRING TENSION WASHER
UTILITY ASSORTMENT
No. 020-351

Contains 210 Tension Washers. 35 each of six sizes in a sturdy, fibreboard container with individual compartments.



Standard Package 100 pieces.

papco **COUNTERSUNK FINISHING WASHERS**



Standard Type

"PAPCO" Countersunk Finishing Washers are made from sheet brass and nickel plated. Used in body trim work with countersunk head screws and bolts.



Flush Type

Standard Package 100 Washers

COUNTERSUNK STANDARD TYPE			
Stock No.	Screw Size	Inside Dia.	Outside Dia.
162-971	#6	.167	7/16
162-973	#8	.193	1/2
162-975	#10	.228	19/32
162-977	#12	.291	11/16
162-979	1/4	.318	25/32
COUNTERSUNK FLUSH TYPE			
162-988	#8	13/64	13/32
162-990	#10	13/64	15/32
162-994	1/4	17/64	5/8

papco **FINISHING WASHER**
GARAGE ASSORTMENT
No. 020-030

Contains 200 Nickel Plated Finishing Washers used with Countersunk Head Screws.

Sizes from No. 6 to 1/4".

Packed in a sturdy, clear plastic container.



papeo® STOVE BOLTS BOULONS DE POELE



195
Flat

FLAT HEAD



BRIGHT
PLATED

ROUND HEAD



196
Round



BRIGHT ELECTRO PLATED

Order by Stock Number

Standard Package 100 Bolts and Nuts.

Stock Numbers			Stock Numbers			Stock Numbers			Stock Numbers		
Flat	Round	Size	Flat	Round	Size	Flat	Round	Size	Flat	Round	Size
195-087	196-087	1/8 x 1/2	195-195	196-195	3/16 x 1-1/4	195-307	196-307	1/4 x 3/4	195-444	196-444	5/16 x 1
195-089	196-089	1/8 x 3/4	195-197	196-197	3/16 x 1-1/2	195-309	196-309	1/4 x 1	195-448	196-448	5/16 x 1-1/2
195-091	196-091	1/8 x 1	195-199	196-199	3/16 x 1-3/4	195-311	196-311	1/4 x 1-1/4	195-451	196-451	5/16 x 2
195-093	196-093	1/8 x 1-1/4	195-200	196-200	3/16 x 2	195-313	196-313	1/4 x 1-1/2	195-453	196-453	5/16 x 2-1/2
195-095	196-095	1/8 x 1-1/2	195-202	196-202	3/16 x 2-1/2	195-315	196-315	1/4 x 1-3/4	195-455	196-455	5/16 x 3
195-189	196-189	3/16 x 1/2	195-204	196-204	3/16 x 3	195-316	196-316	1/4 x 2	195-493	196-493	3/8 x 1-1/2
195-191	196-191	3/16 x 3/4	195-305	196-305	1/4 x 1/2	195-317	196-317	1/4 x 2-1/4	195-496	196-496	3/8 x 2
195-193	196-193	3/16 x 1	195-306	196-306	1/4 x 5/8	195-318	196-318	1/4 x 2-1/2	195-498	196-498	3/8 x 2-1/2
						195-320	196-320	1/4 x 3	195-500	196-500	3/8 x 3

For Slot Drive Stove Bolts see current Price Book.

papeo® STOVE BOLTS ASSORTMENTS ASSORTIMENTS DE BOULONS DE POELE

GARAGE ASSORTMENT No. 020-044 ROUND HEAD

Contains 68 Stove Bolts from
3/16" x 1/2" to 1/4" x 2".



GARAGE ASSORTMENT No. 020-045 FLAT HEAD

Contains 68 Stove Bolts from
3/16" x 1/2" to 1/4" x 2".

Packed in rigid, transparent, plastic containers

STOVE BOLT UTILITY ASSORTMENT No. 020-324

Contains 200 Round Head Stove Bolts, from
3/16" x 1/2" to 1/4" x 2".

UTILITY ASSORTMENT No. 020-323

Contains 80 Round Head Stove Bolts, 6 sizes:
3/16" x 4", 5", 6";
1/4" x 4", 5", 6".

These assortments are packed in sturdy fibreboard
containers. Each size is in a separate compartment.
Retail prices are shown on lid label. Assortment can
be refilled from Standard Packages.



STOVE BOLT and MACHINE SCREW EQUIVALENT SIZES

STOVE BOLT DIAMETER	1/8"	5/32"	3/16"	1/4"	5/16"	3/8"
MACHINE SCREW SIZE	6-32	8-32	10-24	1/4-20	5/16-18	3/8-16

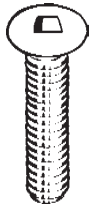

174
Round

papco[®] MACHINE SCREWS VIS DE MECANIQUE

‘LOXXON’ SQUARE SOCKET DRIVE
BRIGHT ELECTRO PLATED



176
Flat

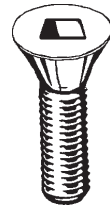

“PAPCO” MACHINE SCREWS are used on window moulding, door handles, instrument panels, lamp rims and many other applications.

Order by Stock Number

Standard Package 100 pieces.

"Papco" Stock Number		Screw Dia.	Threads per Inch	Screw Length	Decimal Equiv. of Dia.	"Papco" Stock Number		Screw Dia.	Threads per Inch	Screw Length	Decimal Equiv. of Dia.
Round	Flat					Round	Flat				
174-039		4	40	1/4	.112"	174-189	176-189	10	24	1/2	.190"
174-043				1/2		3/4					
174-083		6	32	1/4	.138"	174-193	176-193	10	32	1	.190"
174-085	176-085			3/8		1-1/4					
174-087	176-087			1/2		1-1/2					
174-089	176-089			3/4							
174-091	176-091			1							
174-093	176-093			1-1/4							
174-095	176-095	1-1/2									
174-133		8	32	1/4	.164"	174-213		10	32	1/4	.190"
174-135	176-135			3/8		1-1/4					
174-137	176-137			1/2		1-1/2					
174-139	176-139			3/4							
174-141	176-141			1							
174-143	176-143			1-1/4							
174-145	176-145	1-1/2									
174-185		10	24	1/4	.190"	174-219	176-219	1/4	20	3/4	.250"
174-187	176-187			3/8		1-1/2					
						2					

For Slot Drive Machine Screws see current Price Book.

184
Series



HEX MACHINE SCREW NUTS ECROUS DE VIS DE MECANIQUE

BRIGHT ELECTRO PLATED



Order by Stock Number

Standard Package 100 pieces.

"Papco" Stock No.	Size	Threads per Inch	Dimensions		"Papco" Stock No.	Size	Threads per Inch	Dimensions	
			Across Flats	Thickness				Across Flats	Thickness
184-004	4	40	1/4	3/32	184-011	10	32	3/8	1/8
184-005	5	40	5/16	7/64	184-012	12	24	7/16	5/32
184-006	6	32	5/16	7/64	184-014	1/4	20	7/16	3/16
184-008	8	32	11/32	1/8	184-015	1/4	28	7/16	3/16
184-010	10	24	3/8	1/8					



MACHINE SCREWS ASSORTMENTS ASSORTIMENTS VIS DE MECANIQUE

‘LOXXON’ SQUARE SOCKET DRIVE

GARAGE ASSORTMENT No. 020-010

Round Head

Contains 130 Round Head Plated Machine Screws in various sizes and 45 Hexagon Plated Nuts.



GARAGE ASSORTMENT No. 020-011

Flat Head

Contains 130 Flat Head Plated Machine Screws in various sizes and 45 Hexagon Plated Nuts.

Packed in rigid, transparent, plastic containers.



MACHINE SCREW ASSORTMENTS ASSORTIMENTS DE VIS DE MECANIQUE



UTILITY ASSORTMENT No. 020-331

Round Head Square Drive Machine Screws.
Contains 320 Round Head Machine Screws and Nuts.
16 sizes from 4-40 x 1/2" to 10-32 x 1-1/2".

UTILITY ASSORTMENT No. 020-333

Flat Head Square Drive Machine Screws.
Contains 350 Flat Head Machine Screws and Nuts.
Screws – 6-32 x 3/8, 8-32" to 1/4" x 1-1/2".
Nuts – 6-32, 8-32, 10-24, 1/4".

These assortments are packed in sturdy fibreboard metal edged boxes with individual compartments and with illustrated labels showing parts and retail codes.



Metal Merchandiser with moulded compartments.
Size: 9-3/4" w. x 13-3/4" l. x 2" d.

SQUARE DRIVE MACHINE SCREW and NUT MASTER ASSORTMENT No. 020-624

- Contains 1120 pieces - 32 sizes, Round and Flat Head and Hexagon Nuts.
- Metal box with moulded plastic compartments.
- Safety snap carrying handle.
- Actual size illustrations and retail price codes of every item shown on grease-resistant lid label.
- Refills available in standard packages of 100.

A practical assortment that gives complete coverage of all popular sizes of Machine Screws and Nuts.

paulin SUPER SERVICE ASSORTMENT No. 020-806

MACHINE SCREW and NUT SUPER-SERVICE ASSORTMENT No. 020-806

- Contains 2750 pieces - 32 sizes, Round and Flat Head Square Drive Machine Screws with Nuts.
- Large size, rigid metal box with high-strength plastic compartments.
- Convenient, safety snap carrying handle.
- Actual size illustrations and retail codes of every item shown on grease-resistant lid label.
- Refills available in standard packages of 100.

Perfect for Dealers, Jobbers and large users. This popular assortment has a wide range of carefully selected Machine Screws and Nuts in balanced quantities.



Size: 12" w. x 18" l. x 3" d.

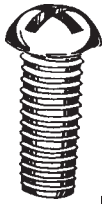

papco PHILLIPS MACHINE SCREWS VIS DE MECANIQUE PHILLIPS



BRIGHT PLATED

Phillips Type (cross recessed) screws are used on all trim applications.

173
Round
Head

175
Oval
Head

Order by Stock Number

Standard Package 100 pieces

Papco Stock Nos.		Screw Diameter	Threads Per Inch	Screw Length	Decimal Equivalent
Round	Oval				
173-085		6	32	3/8"	.138"
173-135		8	32	3/8"	
173-137	175-137			1/2"	.164"
173-139	175-139			3/4"	
173-141	175-141			1"	
173-189		10	24	1/2"	
173-191	175-191			3/4"	.190"
173-193				1"	
173-215		10	32	3/8"	
173-217	175-217			1/2"	.190"
173-219				3/4"	
173-305		1/4	20	1/2"	
173-307	175-307			3/4"	.250"
173-309				1"	

papco PHILLIPS MACHINE SCREW ASSORTMENTS



MASTER ASSORTMENT No. 020-623

- Contains 786 pieces – 20 sizes. Round and Oval Head and Hexagon Nuts.
- Rigid, metal box with handy moulded compartments.
- Carrying handle with safety snap lock.
- Illustrated lid label shows retail codes.
- Refills available in standard packages.

GARAGE ASSORTMENT No. 020-012 Round Head

Assortment contains 100 Plated Phillips Head Machine Screws and 50 Hexagon Plated Nuts in popular sizes.

Packed in a rigid, transparent plastic container.

Order by Stock Number.





197
Flat
Steel



Papco WOOD SCREWS VIS A BOIS

'LOXXON' SQUARE SOCKET DRIVE

"Papco" Wood Screws are available in over 300 stock sizes in Brass and Steel and in various Head Styles and Drives. All 'Papco' Steel Wood Screws listed here are Bright Plated.



198
Round
Steel

203
Flat
Brass

204
Round
Brass

Flat Socket Steel add prefix 197
Flat Socket Brass add prefix 203



Round Socket Steel add prefix 198
Round Socket Brass add prefix 204

Example of Stock No. 197-139 is 8 x 3/4 Flat Socket Steel Wood Screws Plated.

Example of Stock No. 203-139 is 8 x 3/4 Flat Socket Brass Wood Screws.

Order by Stock Number

Standard Package 100 Screws

Diameter	No. 4	No. 5	No. 6	No. 7	No. 8	No. 9	No. 10	No. 12	No. 14
Decimal Equiv. of Diameter	.112	.125	.138	.155	.165	.177	.191	.218	.251
Drill Pilot Hole*	3/64	1/16	1/16	1/16	5/64	5/64	3/32	7/64	7/64
Drill Shank Hole*	7/64	1/8	9/64	5/32	11/64	3/16	3/16	7/32	1/4
Length									
1/2	-043	-063	-087	-111	-137				STEEL SOCKET ONLY
5/8	-044	-064	-088	-112	-138				
3/4	-045	-065	-089	-113	-139		-191		
1	-047	-067	-091	-115	-141	-167	-193	-250	-280
1-1/4			-093	-117	-143	-169	-195	-252	-282
1-1/2			-095	-119	-145	-171	-197	-254	-284
1-3/4							-199		-286
2					-148		-200	-257	-287
2-1/2					-150		-202	-259	-289
3							-204	-261	-291

* Sizes of holes recommended for average application. Slightly larger or smaller holes may be required for hard or soft woods.

Note: Additional sizes of Wood Screws in Steel, Brass, Stainless Steel and Silicon Bronze are available - see current Non-Ferrous catalogue.

Papco WOOD SCREWS ASSORTMENTS ASSORTIMENTS DE VIS A BOIS

GARAGE ASSORTMENT

No. 020-201

STEEL

Contains 160 pieces - 8 sizes of Flat Socket Head Steel Wood Screws Plated. Packed in a transparent plastic box.



GARAGE ASSORTMENT

No. 020-210

BRASS

Contains 155 pieces - 8 sizes of mostly Flat and Round Socket Head Brass Wood Screws from 6 x 1/2 to 8 x 1-1/2. Packed in a transparent plastic box.



UTILITY ASSORTMENT

No. 020-354

STEEL

Contains 460 pieces Flat and Round Socket Steel Wood Screws Plated. Twelve sizes from No. 4 x 1/2 to No. 10 x 1-1/2. Strong display box with moulded plastic compartments. Refills available in standard packages.



UTILITY ASSORTMENT

No. 020-356

BRASS

Contains 380 pieces Flat and Round Socket Brass Wood Screws. Twelve sizes from No. 4 x 1/2 to No. 10 x 1-1/2. Packed in a sturdy fibre - board container.

MASTER ASSORTMENT

No. 020-600

STEEL

Contains 850 pieces Flat and Round Socket Steel Wood Screws Plated. Twelve sizes from No. 4 x 1/2 to No. 10 x 1-1/2. Packed in a metal box with moulded plastic compartments.

MASTER ASSORTMENT

No. 020-601

BRASS

Contains 735 pieces Flat and Round Socket Brass Wood Screws. Twelve sizes from No. 4 x 1/2 to No. 10 x 1-1/2. Packed in a metal box with moulded plastic compartments.



Papco TAPPING SCREWS VIS TARAUDEUSES



SHEET METAL SCREWS SLOT HEAD BRIGHT PLATED

205
Pan
Head

SELF-TAPPING



HARDENED

206
Oval
Head

"Papco" Sheet Metal Screws are used in the assembly of sheet metal parts and for making fastenings to sheet metal. They are used in body work for attaching window moulding, trim, panels, metal drip moulding and many other applications.

Order by Stock Number

Standard Package 100 pieces.

Pan Head Stock No.	Oval Head Stock No.	Screw Dia.	Screw Length	Decimal Eq. of Dia.	Drill Hole	Pan Head Stock No.	Oval Head Stock No.	Screw Dia.	Screw Length	Decimal Eq. of Dia.	Drill Hole	
205-039			1/4			205-187			3/8			
205-041		4	3/8	.112"	5/64"	205-189	206-189		1/2			
205-043	206-043		1/2			5/8						
205-044	206-044		5/8			10	3/4	.191"	9/64"			
205-083			1/4					205-193	206-193		1	
205-085	206-085		3/8			205-195	206-195		1-1/4			
205-087	206-087		1/2			205-197			1-1/2			
205-088	206-088	6	5/8	.138"	3/32"	205-247			5/8			
205-089	206-089		3/4			205-248	206-248		3/4			
205-091	206-091		1			205-250	206-250	12	1	.218"	5/32"	
205-093	206-093		1-1/4			205-252			1-1/4			
205-135			3/8			205-254	206-254		1-1/2			
205-137	206-137		1/2			205-278	206-278		3/4			
205-138	206-138		5/8			205-280	206-280	14	1	.251"	3/16"	
205-139	206-139	8	3/4	.165"	1/8"	205-282			1-1/4			
205-141	206-141		1									
205-143	206-143		1-1/4									
205-145			1-1/2									

223
Series

Papco THREAD CUTTING SCREWS VIS A FILETAGE COUPANT

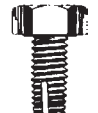

TYPE 1 SCREWS
BRIGHT PLATED

Round Hexagon

These hardened screws cut their own Standard Machine Screw Thread in any metal. The off-centre thread cutting slot acts as a tap when the screw is driven. 'Papco' Thread Cutting Screws are ideal to have on hand when stripped threads need repair.

Order by Stock Number

Standard Package 100 pieces.

Stock No.	Size	Head Type	Decimal Dia.	Drill Hole
223-010	4-40 x 3/8	Round	.112"	#43
223-014	6-32 x 3/8	Pan		
223-016	6-32 x 1/2	Round	.138"	#34 (.111)
223-022	6-32 x 3/4	Round		
223-034	8-32 x 3/8	Round		
223-037	8-32 x 1/2	Round	.164"	#28 (.140)
223-043	8-32 x 3/4	Round		
223-058	10-24 x 1/2	Round	.190"	#21 (.159)
223-068	10-24 x 1	Pan		
223-079	10-32 x 1/2	Round	.190"	#19 (.166)
223-086	10-32 x 3/4	Round		
223-103	12-24 x 1/2	Round	.216"	3/16
223-120	1/4-20 x 1/2	Round	.250"	7/32
223-131	1/4-20 x 1	Hex		
223-143	5/16-18 x 1/2	Hex	.312"	9/32
223-152	5/16-18 x 1	Hex		



THREAD CUTTING SCREW ASSORTMENT No. 020-856

- Contains 250 Screws, 16 sizes.
- Needed in every shop and Service Department
- Like having a set of Machine Screw Size Taps.
- Cuts all threads from 4-40 to 5/16-18.
- Rigid, plastic compartmentized container.

papco® TAPPING SCREW ASSORTMENTS ASSORTIMENTS VIS TARAUDEUSES



GARAGE ASSORTMENT No. 020-024

HEXAGON HEAD

Contains 100 Hexagon Head Tapping Screws in various lengths and diameters from 8 x 1/2 to 5/16 x 1.



GARAGE ASSORTMENT No. 020-026

PAN SLOT

Contains 165 Pan Slot Head Tapping Screws in various lengths and diameters from 4 x 1/2 to 14 x 1.

GARAGE ASSORTMENT No. 020-200

PAN SOCKET

Contains 175 Pan Socket Head Tapping Screws in various lengths and diameters from 6 x 1/2 to 10 x 1.

TAPPING SCREW UTILITY ASSORTMENT No. 020-312

SLOT

Contains 495 pieces – 18 sizes, Pan and Oval Slot Heads. Packed in a sturdy fibreboard container with plastic tray. Actual size illustrations and retail price codes of every item shown on lid label.



No. 020-312
Size: 7-1/2" x 12" x 1-1/4"

TAPPING SCREW UTILITY ASSORTMENT No. 020-353

SOCKET

Contains 500 pieces – 16 sizes, Pan Socket Head. Packed in a sturdy fibreboard container with moulded plastic trays. Refills available in standard packages.

Here are two assortments of "Papco: Sheet Metal Screws designed especially for Dealers, Service Stations and Garages. Use these attractive, permanent merchandisers to increase your sales – and profits – on this fast moving line!

TAPPING SCREW MASTER ASSORTMENT No. 020-612

SLOT

Contains 937 pieces – 18 sizes of Pan, Oval and Hex Slot Tapping Screws. Metal box with moulded plastic compartments and hinged lid. Actual size illustrations on lid label. Refills available in standard packages.



Metal Merchandiser with moulded compartments
Size: 9-3/4" w. x 13-3/4" l. x 2" d.

No. 020-612

TAPPING SCREW MASTER ASSORTMENT No. 020-660

SOCKET

Contains 1000 pieces — 25 sizes of Pan Socket Head Tapping Screws. Packed in a metal box with high-strength plastic compartments. Actual size illustrations and retail price codes of every item shown on grease-resistant lid label.



TAPPING SCREW MASTER ASSORTMENT No. 020-615

Excellent assortment of Hexagon Steel Metal Screws and Fender Washers for the well-equipped Body Shop

- Contains 280 Hexagon Head Screws
- 125 Flat Fender Washers
- 20 Popular Sizes

Size: 9-3/4" w. x 13-3/4" l. x 2" d.

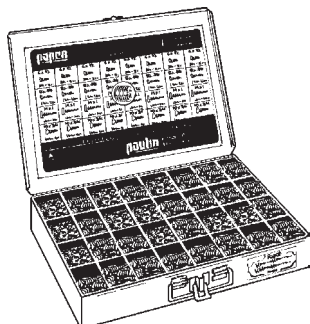

papco SUPER SERVICE ASSORTMENT No. 020-807

Contains 1450 Pan and Oval Slot Head Tapping Screws — 32 items. Large size, rigid metal box with high-strength plastic compartments.

For more details see page 9.

Large size: 12" w. x 18" l. x 3" d.



papco

**SOCKET TAPPING SCREWS
VIS TARAUEUSES CREUSE**

'LOXXON'® SQUARE SOCKET DRIVE

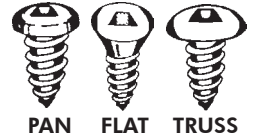

208 Pan Head	209 Flat Head	210 Truss Head
---------------------------	----------------------------	-----------------------------

SHEET METAL SCREWS

SELF-TAPPING



BRIGHT PLATED

HARDENED

Specify "Papco" Pan, Flat or Truss Socket Head Tapping Screws where a positive driver engagement, or where high-speed assembly of sheet metal parts, is required. They are used in body work, mouldings, trim, sheet metal work and many other applications.

Order by Stock Number

Standard Package 100 pieces.

Pan Head Stock No.	Flat Head Stock No.	Truss Hd. Stock No.	Screw Dia.	Screw Length	Decimal Eq. of Dia.	Drill Hole	Pan Head Stock No.	Flat Head Stock No.	Truss Hd. Stock No.	Screw Dia.	Screw Length	Decimal Eq. of Dia.	Drill Hole
208-039				1/4			208-187				3/8		
208-041	209-041			3/8			208-189	209-189	210-189		1/2		
208-043	209-043		4	1/2	.112"	5/64"	208-190	209-190	210-190		5/8		
208-045	209-045			3/4			208-191	209-191	210-191	10	3/4	.191"	9/64"
208-047	209-047			1			208-193	209-193	210-193		1		
208-083				1/4			208-195	209-195	210-195		1-1/4		
208-085	209-085	210-085		3/8			208-197	209-197			1-1/2		
208-087	209-087	210-087		1/2			208-200	209-200			2		
208-088	209-088	210-088	6	5/8	.138"	3/32"	208-246	209-246			1/2		
208-089	209-089	210-089		3/4			208-248	209-248			3/4		
208-091	209-091	210-091		1			208-250	209-250		12	1	.218"	5/32"
208-093	209-093			1-1/4			208-252	209-252			1-1/4		
208-095	209-095			1-1/2			208-254	209-254			1-1/2		
208-135		210-135		3/8			208-257				2		
208-137	209-137	210-137		1/2			208-277	209-277			5/8		
208-138	209-138	210-138		5/8			208-278	209-278			3/4		
208-139	209-139	210-139	8	3/4	.165"	1/8"	208-280	209-280		14	1	.251"	3/16"
208-141	209-141	210-141		1			208-282	209-282			1-1/4		
208-143	209-143	210-143		1-1/4			208-284	209-284			1-1/2		
208-145	209-145	210-145		1-1/2			208-287	209-287			2		
208-148	209-148			2									

213
Hex
Head

papco

**HEX HEAD TAPPING SCREWS
VIS TARAUEUSES TETE HEX**



PLATED

SELF-TAPPING

HARDENED

Oversize Hexagon Washer Heads to fit Automotive Cap Screw Wrenches.

Order by Stock Number

Standard Package 100 pieces.

'Papco' Stock No.	Screw Dia.	Screw Length	Decimal Eq. of Dia.	Across Flats	Drill Hole	'Papco' Stock No.	Screw Dia.	Screw Length	Decimal Eq. of Dia.	Across Flats	Drill Hole
213-085	6	3/8	.138"	1/4"	3/32"	213-250	12	1	.218"	5/16"	5/32"
213-137		1/2				213-276		1/2			
213-139		3/4				213-277		5/8			
213-141	8	1	.165"	1/4"	1/8"	213-278	14	3/4	.251"	7/16"	3/16"
213-143		1-1/4				213-280		1			
213-145		1-1/2				213-282		1-1/4			
213-187		3/8				213-284		1-1/2			
213-189		1/2				213-442		3/4			
213-190	10	5/8	.191"	5/16"	9/64"	213-444	5/16	1	.312"	1/2"	9/32"
213-191		3/4				213-446		1-1/4			
213-193		1				213-448		1-1/2			
213-246	12	1/2	.218"	5/16"	5/32"	213-489	3/8	1	.375"	9/16"	11/32"
213-248		3/4				213-493		1-1/2			

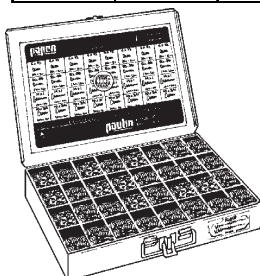

papco

SUPER SERVICE ASSORTMENT No. 020-808

Contains 650 Hexagon Head Tapping Screws and Fender Washers.
Large size, rigid metal box with high-strength plastic compartments.

For more details see page 9.

Large size: 12" w. x 18" l. x 3" d.



140
Carded

papeco POWER DRIVER BITS POINTES DE TOURNEVIS

• 2 PIECE CONSTRUCTION • 'LOXXON' SQUARE DRIVE

8140
Packaged

'Papco' 'Loxxon' Square Drive Bits are precision crafted from impact resistant tool steel and offer the best combination of hardness and toughness for maximum durability. Available in 1, 2, 3, 4 and 6 inch lengths.

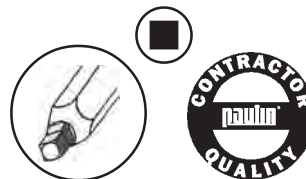

S2 STEEL

Order by Stock Number

Individually Carded* or Packaged

Bit Size	1" Long			2" Long			3" Long	4" Long	6" Long	Fits Screw Dia.
	Carded Stock No.	Packaged Stock No.	Std. Pkg.	Carded Stock No.	Packaged Stock No.	Std. Pkg.	Carded Stock No.	Carded Stock No.	Carded Stock No.	
No. 0	140-310*	—	—	—	—	—	—	—	—	No.3 & 4
No. 1	140-311*	8140-311	10	140-321	8140-321	10	140-331	140-341	140-361	No.5 to 7
No. 2	140-312*	8140-312	25	140-322	8140-322	10	140-332	140-342	140-362	No.8 to 10
No. 3	140-313*	8140-313	10	140-323	8140-323	10	140-333	140-343	140-363	No.12 & 14

* Indicates 2 bits per card

Available in Bulk - price on application.

140
Carded

papeco POWER DRIVER BITS POINTES DE TOURNEVIS

PHILLIPS DRIVE

8140
Packaged

'Papco' Phillips Drive bits are made of the same impact resistant hardened tool steel as the Loxxon Square Drive Bits for maximum performance.

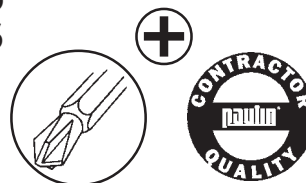

Order by Stock Number

Individually Carded* or Packaged

Bit Size	1" Long			2" Long			3" Long	4" Long	Fits Screw Dia.
	Carded Stock No.	Packaged Stock No.	Std. Pkg.	Carded Stock No.	Packaged Stock No.	Std. Pkg.	Carded Stock No.	Carded Stock No.	
No. 1	140-411*	8140-411	10	140-421	8140-421	10	—	—	No.2 to 4
No. 2	140-412*	8140-412	25	140-424	8140-424	10	—	—	No.5 to 10
No. 3	140-413*	8140-413	10	140-423	8140-423	10	—	—	No.12 to 16
Drywall	140-422*	8140-422	25	—	—	—	—	—	All Drywall Scrs.

* Indicates 2 bits per card

Available in Bulk - price on application.

8020
Series

papeco ASSORTED BIT KITS JEUX DES POINTE ASSORTIS



8020-900

Choose from 4 skin-packed Assorted Bit Kits each containing No. 1,2 and 3 bit sizes in either 'Loxxon' Square Drive or Phillips in either 1" or 2" bit lengths.



1" 'LOXXON' SQUARE DRIVE ASSORTED BITS KIT No. 8020-900



2" 'LOXXON' SQUARE DRIVE ASSORTED BITS KIT No. 8020-901



1" PHILLIPS DRIVE ASSORTED BITS KIT No. 8020-902



2" PHILLIPS DRIVE ASSORTED BITS KIT No. 8020-903

7 Pc. BIT ASSORTMENT No. 8020-907

Contains six 1" long 'Loxxon' Square Drive and Phillips Drive bits in No. 1,2 and 3 bit sizes - plus a 1/4 x 3" magnetic Bit Holder in a clear plastic pack.

14 Pc. BIT ASSORTMENT No. 8020-915

Contains six 1" and 2" long 'Loxxon' Square Drive bits - six 1" and 2" long Phillips Drive bits in No. 1,2 and 3 bit sizes - plus two 6-Lobe bits in a see-through plastic pack.

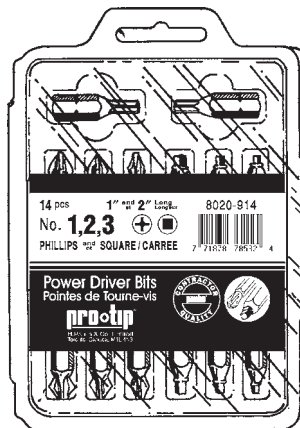

8020-915



222
Series

papeco BIT ACCESSORIES ACCESSORIE DE POINTES

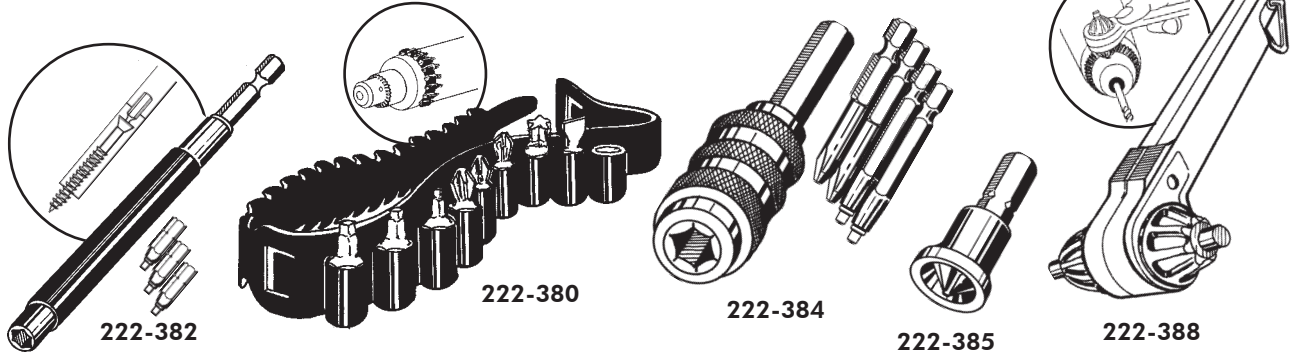

Order by Stock Number

Individually Skin-packed

Stock No.	Description
222-380	Power Bit Belt - straps to most power drills - Includes 9 assorted bits including 6-Lobe
222-382	Screw Starter Driver - sliding guide sleeve over magnetic chuck - includes 3 square drive bits
222-384	Quick Change Chuck - includes four 2" long assorted 'Loxxon' and Phillips bits (No. 1 and 2 Points)
222-385	Drywall Screw Dimpler - includes Drywall Screw Bit
222-388	Ratchet Key - chuck key for most power drills and bench tools - fast bit change-overs

papeco CARDED BIT MERCHANDISER No. 022-154

Contains 11 sizes of 1, 2 and 3 inch long carded bits in No. 1 to 3 'Loxxon' Square and Phillips Drives - plus two sizes of 6-Lobe Drive Bits. Also includes Assorted Bit Kits No. 8020-900, 901, 902 and 903 of 1 and 2 inch long Square and Phillips Bits. Magnetic Bit Holder 222-355, 6 in 1 Magnetic Screwdriver 222-995 and Magnetic 6-Lobe Screwdriver 231-975 for a grand total of 20 items - 54 cards on an attractive, point-of-purchase display rack that can be hung on a wall or displayed on a counter.

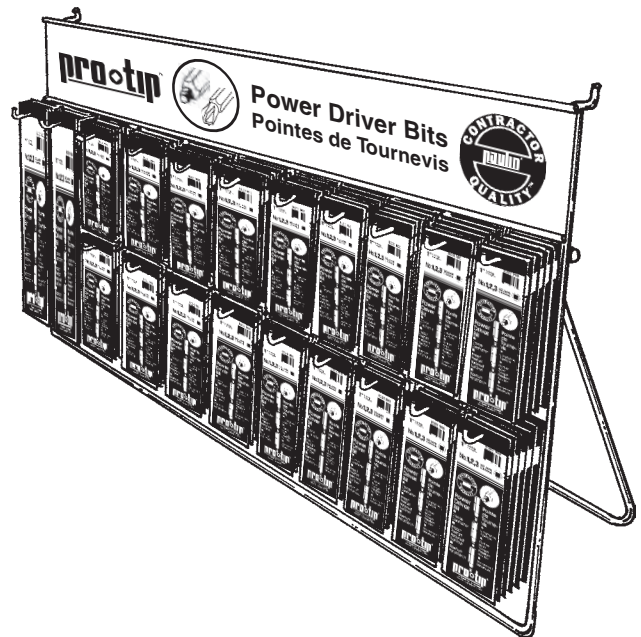

papeco 7 Pc. POCKET KIT SCREWDRIVERS

Injection molded plastic hinged kit features No. 1 and No. 2 'Loxxon' Square Drive Bits and Phillips Bits, 8-10 Slot Bit, T-15 6-Lobe Bit and a 2" Magnetic Bit Holder. Handy belt clip attached.

Order by Stock Number Individually Carded

Stock No.	Colour	Stock No.	Colour
020-923	Green	020-926	Red
020-924	Yellow	020-927	Black
020-925	Orange		

POCKET KIT COUNTER DISPLAY No. 020-928
Contains 24 Pocket Screwdriver Kits No. 020-927 in an attractive counter display box.

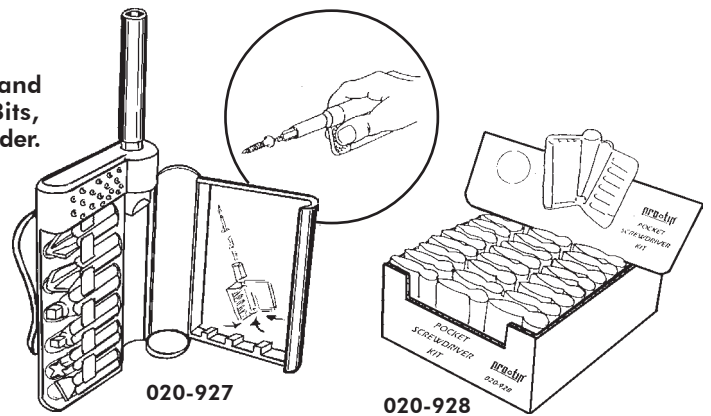

140
Series

papco® **SCREWDRIVERS**
TOURNEVIS
`LOXXON`® **SQUARE DRIVE**



Heat treated alloy driver tip manufactured to precise specifications and assembled with an electro-plated steel blade. Ergonomically designed Butyrate handles for comfortable grip - colour coded for identification.



Order by Stock Number

Individually Packaged

Bit Size	Handle Colour	STUBBY Stock No.	JUNIOR Stock No.	STANDARD Stock No.	LARGE Stock No.	X-LARGE Stock No.	Fits Screw Dia.
No. 0	Yellow	—	140-377	—	—	—	No. 3 & 4
No. 1	Green	140-373	140-378	140-383	140-388	140-393	No. 5 to 7
No. 2	Red	140-374	140-379	140-384	140-389	140-394	No. 8 to 10
No. 3	Black	140-375	140-380	140-385	140-390	140-395	No. 12 & 14
Overall Length		3-1/2"	7-1/2"	9"	9-1/2"	13"	

For 6-Lobe Bull-Dog Screwdrivers and Bits see page 77.

222
Series

papco® **MAGNETIC NUTSETTERS**
INSTALLEUR MAGNETIQUE D'ECROU

"Papco" Nutsetters with a permanent high strength Alnico magnet are manufactured from high quality tool steel and heat treated for long life.



Order by Stock Number

1/4" Hex Shank

Individually Packaged

Stock No.	Size x Overall Length	Socket Body Dia.	Stock No.	Size x Overall Length	Socket Body Dia.
222-360	1/4 Hex x 1-7/8	7/16	222-370	1/4 Hex x 2-9/16	7/16
222-365	5/16 Hex x 1-7/8	1/2	222-375	5/16 Hex x 2-9/16	1/2
222-366	3/8 Hex x 1-7/8	9/16	222-376	3/8 Hex x 2-9/16	9/16
222-367	7/16 Hex x 1-7/8	5/8	222-377	7/16 Hex x 2-9/16	5/8
222-368	1/2 Hex x 1-7/8	11/16	222-378	1/2 Hex x 2-9/16	11/16
222-355	1/4 Hex x 3	7/16 Magnetic Bit Holder - 303 Stainless Steel			

Available in Bulk - price on application.

8020
Series

papco® **ASSORTED NUTSETTER KITS**
JEUX D'INSTALLEUR D'ECROU

1 7/8" KIT No. 8020-905
Contains one each of 1/4, 5/16 and 3/8 Hex Magnetic Nutsetters in a clear tamper-proof pack.

2 9/16" KIT No. 8020-906
Contains one each of 1/4, 5/16 and 3/8 Hex Magnetic Nutsetters in an attractive transparent pack.





222 Series

papco 'SPEE-DRILL'® SCREWS
VIS 'SPEE-DRILL'®

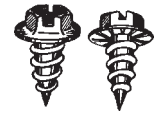

• THREAD FORMING • SELF DRILLING

'Papco' Spee-Drill Screws are driven with a standard electric drill. The special hardened conical point bores through sheet metal and the serrated washer face prevents thread stripping.

Standard Package 100 pieces
* Standard Package 1000 pieces

Order by Stock Number

100's Stock No.	*1000's Stock No.	Size Diameter x Length	100's Stock No.	*1000's Stock No.	Size Diameter x Length
222-085	222-585	6 x 3/8	222-189	222-689	10 x 1/2
222-111	222-611	7 x 1/2	222-191	222-691	10 x 3/4
222-137	222-637	8 x 1/2			

Note: All 'Papco' Spee-Drill Screws are Hex, Slotted, Washer Head with 1/4" across flats head size.

papco **6 in 1 MAGNETIC SCREWDRIVER SET**
JEU DE TOURNEVIS AIMANTE

No. 222-996

Uses 1/4" Hex Base Bits

Magnetized shaft holds bit and screw for easy use. Driver comes complete with six high quality bits - 1/4" Slotted, #1 and #2 Phillips, #1 and #2 Loxxon Square Socket and a T-15 6-Lobe. When not in use bits are stored in an impact-resistant, plastic handle. Shaft end can be used as a nut driver. Screw driver with 6 bits skin-packed on a handy point-of-purchase display card.



6-LOBE MAGNETIC SCREWDRIVER SET
JEU DE TOURNEVIS AIMANTE

No. 231-975

Same Magnetic Screwdriver as above. Driver comes complete with four high quality 6-Lobe bits - T-10, T-15, T-20 and T-25. Driver and bits skin packed on colourful self-selling display card.

'SPEE-DRILL' SCREW KIT
No. 020-617

Contains 1,000 'Papco' Spee-Drill Screws, 5 sizes and includes the 'Papco' Magnetic Chuck
No. 222-360.

- All-metal box with hinged lid.
- Safety snap lock and carrying handle.
- Grease-resistant lid label with retail codes.



papco **MAGNETIC CHUCK**
MANDRIN MAGNETIQUE
No. 222-360

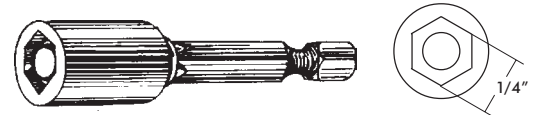

Individually Packaged

Fits all five sizes of 'Papco' Spee-Drill Screws. Fits standard electric drill. Has hexagon shank for positive drive. Permanent high-strength Alnico magnet. Made of heat treated tool steel for long life.
Order by Stock Number 222-360

229 Series

papco **TRIM SCREWS**
VIS FINITION



BRIGHT CHROMIUM OR BLACK OXIDE PLATED



① Black Oxide
ROUND PHILLIPS WASHERS HEAD

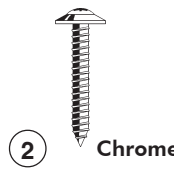

② Chrome
OVAL PHILLIPS SEMS



③ Black Oxide

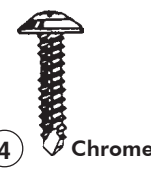

④ Chrome
ROUND PHILLIPS 'DRILL-X' SEMS

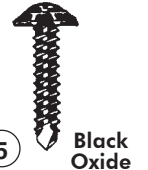

⑤ Black Oxide

Order by Stock Number

Standard Package Type 1=100 pieces, Types 2 to 5=50pcs.

Stock No.	Diameter x Length	Hd. Type	Stock No.	Diameter x Length	Hd. Type	Stock No.	Diameter x Length	Hd. Type
229-401	8 x 1/2	1	229-806	6 x 3/4	2 O.R.	229-849	8 x 5/8	3 O.S.
229-402	8 x 5/8	1	229-811	8 x 3/4	2 O.S.	229-851	8 x 3/4	3 O.S.
229-403	8 x 3/4	1	229-815	8 x 1	2 O.S.	229-855	8 x 1	3 O.S.
229-405	8 x 1	1	229-819	8 x 1-1/4	2 O.S.	229-883	10 x 3/4	3 O.S.
229-407	8 x 1-1/4	1	229-833	10 x 3/4	2 O.S.	229-887	10 x 1	3 O.S.
229-414	10 x 3/4	1	229-837	10 x 1	2 O.S.	229-985	8 x 3/4	4 O.S.
229-416	10 x 1	1				229-986	8 x 1	4 O.S.
						229-987	8 x 3/4	5 O.S.
						229-988	8 x 1	5 O.S.

O.S. - OVAL SMALL HEAD

O.R. - OVAL REGULAR HEAD

For 'Papco' Trim Screws Master Assortments No. 020-661 and -662 see page 7.

229
Series

papeo PHILLIPS TAPPING SCREWS
VIS TARAUEUSES PHILLIPS

(SHEET METAL SCREWS)



RECESSED HEAD
Self-Tapping



BRIGHT PLATED
Hardened

OVAL
REGULAR

PAN
HEAD

Order by Stock Number

Standard Package 100 pieces

Stock No.	Diameter x Length	Hd. Type	Stock No.	Diameter x Length	Hd. Type	Stock No.	Diameter x Length	Hd. Type
229-010	6x1/2	O.R.	229-041	10x5/8	O.R.	229-124	8x1	P.H.
229-012	6x3/4	O.R.	229-044	10x1	O.R.	229-140	10x1/2	P.H.
229-014	6x1	O.R.	229-108	6x3/8	P.H.	229-142	10x3/4	P.H.
229-016	6x1-1/4	O.R.	229-110	6x1/2	P.H.	229-144	10x1	P.H.
229-022	8x3/4	O.R.	229-119	8x3/8	P.H.	229-160	12x1/2	P.H.
229-024	8x1	O.R.	229-120	8x1/2	P.H.	229-164	12x1	P.H.
229-026	8x1-1/4	O.R.	229-122	8x3/4	P.H.			

O.R. - OVAL REGULAR

P.H. - PAN HEAD



OVAL HEAD

papeo TRIM SCREWS
VIS FINITION



PAN HEAD

These Oval and Pan Phillips Head Screws are used in all interior and exterior trim applications on cars and trucks.

ZINC OR BLACK OXIDE PLATED

Order by Stock Number

Standard Package 100 pieces

Stock No.	Diameter x Length	Hd. Type	Stock No.	Diameter x Length	Hd. Type	Stock No.	Diameter x Length	Hd. Type
229-219	8 x 3/8 Zinc	O.S.	229-242	10 x 3/4 Zinc	O.S.	229-923	8 x 1-1/2 Black	O.S.
229-220	8 x 1/2 Zinc	O.S.	229-244	10 x 1 Zinc	O.S.	229-933	10 x 3/4 Black	O.S.
229-222	8 x 3/4 Zinc	O.S.	229-248	10 x 1-1/2 Zinc	O.S.	229-937	10 x 1 Black	O.S.
229-224	8 x 1 Zinc	O.S.	229-250	10 x 2 Zinc	O.S.	229-945	10 x 1-1/2 Black	O.S.
229-225	8 x 1-1/8 Zinc	O.S.	229-252	10 x 2-1/2 Zinc	O.S.	229-960	6 x 1/2 Black	P.H.
229-226	8 x 1-1/4 Zinc	O.S.	229-911	8 x 3/4 Black	O.S.	229-962	8 x 1/2 Black	P.H.
229-227	8 x 1-3/8 Zinc	O.S.	229-912	8 x 3/4 Black	O.R.	229-968	8 x 3/4 Black	P.H.
229-228	8 x 1-1/2 Zinc	O.S.	229-915	8 x 1 Black	O.S.	229-972	8 x 1 Black	P.H.
229-229	8 x 1-3/4 Zinc	O.S.	229-916	8 x 1 Black	O.R.	229-980	10 x 3/4 Black	P.H.
229-240	10 x 1/2 Zinc	O.S.	229-919	8 x 1-1/4 Black	O.S.	229-982	10 x 1 Black	P.H.
229-241	10 x 5/8 Zinc	O.S.						

O.S. - OVAL SMALL HEAD

O.R. - OVAL REGULAR HEAD

P.H. - PAN HEAD

**TRIM SCREW
GARAGE ASSORTMENT
No. 020-023**

Contains 100 Phillips Head Self-Tapping Sheet Metal Screws in nine popular sizes - in Oval Regular and Oval Small types. Packed in a rigid, clear plastic box with hinged lid.



**TRIM SCREW
GARAGE ASSORTMENT
No. 020-027**

Contains 100 Metric Zinc Plated Trim Screws in Pan Oval and Round Washer heads. Six sizes in a clear plastic box. (See next page.)



**TRIM SCREW
MASTER ASSORTMENT No. 020-613**

- A well-balanced assortment of Tapping Screws for Trim, Body and Fender work.
- Contains 530 Screws. 25 sizes PHILLIPS HEAD - Self-Tapping Sheet Metal Screws.
- Safety snap carrying handle.
- Metal box with handy moulded compartments.
- Actual size illustrated lid label with retail codes.
- Refills available in standard packages of 100.

Size: 9-3/4" w. x
13-3/4" l. x 2" d.

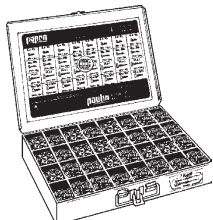

papeo SUPER SERVICE ASSORTMENT No. 020-809

Contains 1225 Phillips Trim Tapping Screws - 30 items
Large size, rigid metal box with high-strength plastic compartments.
For more details see page 9. Large size: 12" w. x 18" l. x 3" d.



230
Series



METRIC TRIM SCREWS VIS FINITION METRIQUE

**`POZI-DRIV` TAPPING SCREWS
BRIGHT CHROMIUM PLATED***

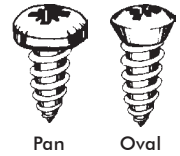

Order by Stock Number

Standard Package 100 pieces

PAN HEAD			OVAL SMALL HEAD		
Stock No.	Dia. x Length	Factory No.	Stock No.	Dia. x Length	Factory No.
230-203	4.2 x 13mm	11503482	230-207	4.2 x 20mm	11502471
230-205	4.2 x 20mm	11501929			
230-206*	4.2 x 20mm	11500406			

*18.8 Stainless Steel Bright Chromium Plated

Note: 4.2mm=No. 8 diameter (.164")

230
Series



METRIC MOULDING TRIM SCREWS VIS FINITION MOULDRE METRIQUE

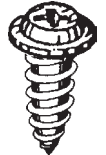

**ROUND LARGE CROWNED WASHER HEAD
`POZI-DRIV` TAPPING SCREWS**

Used in body work for attaching the chrome moulding in the wheel well and floor stripping of late model cars and trucks.

BRIGHT CHROMIUM PLATED

Order by Stock Number

Standard Package 100 pieces

Stock No.	Dia. x Length	Factory No.	Stock No.	Dia. x Length	Factory No.
230-301	4.2 x 8mm	11503266	230-304	4.2 x 16mm	11503635
230-302	4.2 x 12mm	11501794	230-305	4.2 x 20mm	-
230-303	4.2 x 12mm Black	11501896	230-306	4.2 x 20mm Black	11501884

Note: 4.2mm=No. 8 diameter (.164")

225
Series



TRUCK AND TRAILER FASTENERS ATTACHE DE CAMION ET REMORQUE

PLYWOOD LINING SCREWS

Used to fasten plywood liners to body studs and frames.

Order by Stock Number

Standard Package 100 pieces

Stock No. 225-182 #18 x 2"

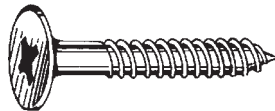

Special Flush Head - Phillips - Wood Screw
Bright Plated Steel

Stock No. 225-186 #10 x 1-1/4"



Special Flush Head - Phillips - Type A
Bright Plated Steel Hardened Tapping Screws

Stock No. 225-183 #10 x 3/4"

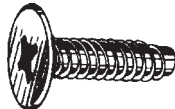

Special Flush Head - Phillips - Thread Forming - Type B
Bright Plated Steel Hardened Tapping Screws
Drill 3/32" pilot hole.

Stock No. 225-188 #14 x 2-1/2"



Flat Socket Head - Wood Screw
Bright Plated Steel

Stock No. 225-184 #14 x 3"



Flat Head - Phillips - Wood Screw
Bright Plated Steel

papeco ALUMINUM PANEL RIVETS



Stock No.
225-196



Stock No.
225-197

Made from heat treated aluminum.
225-196 3/16 x 7/16 Full Brazier Head.
225-197 1/4 x 7/16 Mod. Brazier Head.
Used to fasten aluminum panels.

PAPCO THREAD CUTTING FLOORBOARD SCREWS



225 Series



Phillips Drive

Flat Head Type "F"
BRIGHT ZINC PLATED

Used to fasten wood plank, laminated plywood or corrugated aluminum flooring to the supporting steel cross members of trucks and trailers.



Square Drive

Order by Stock Number

Standard Package 100 Pcs.

Stock No.	Size	Driver	Stock No.	Size	Driver
225-792	1/4-20 x 1-1/2	No. 3 Phillips	225-752	1/4-20 x 1-1/2	No. 3 Square
225-793	1/4-20 x 2"	No. 3 Phillips	225-753	1/4-20 x 2"	No. 3 Square
225-794	1/4-20 x 2-1/2	No. 3 Phillips	225-754	1/4-20 x 2-1/2	No. 3 Square
225-795	1/4-20 x 3"	No. 3 Phillips	225-755	1/4-20 x 3"	No. 3 Square

PAPCO 6-LOBE FLOORBOARD SCREWS



6-Lobe Flat Head Type "F"
- Phosphate and Oil Finish

Order by Stock Number

Standard Package 50 Pcs.

Stock No.	Size	Driver	Stock No.	Size	Driver
225-890	1/4-20 x 1"	T-30	225-895	1/4-20 X 3"	T-30
225-891	1/4-20 x 1-1/4	T-30	225-896	5/16-18 X 1-3/4	T-40
225-892	1/4-20 x 1-1/2	T-30	225-897	5/16-18 X 2"	T-40
225-893	1/4-20 x 2"	T-30	225-898	5/16-18 X 2-1/2	T-40
225-894	1/4-20 x 2-1/2	T-30			

PAPCO 'DRILL-X' SELF-DRILLING TAPPING SCREWS

VIS TARAUD FORET DRILL-X®

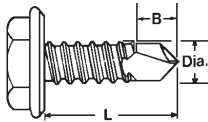

BRIGHT PLATED

232 Series

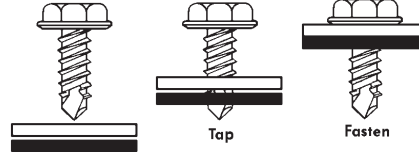

Drill Point length determines maximum metal thickness drillable.
#2 Point up to .110 Thick #3 Point up to .250 Thick

'Papco' Self-Drilling and Tapping Screws are made of high-quality steel and are specially heat treated. The drill point has been incorporated into the screw in the familiar twist drill design. These screws drill their own hole - form mating threads - fasten securely and can be used in steel, plastics, composite materials, wood plus various laminates. Determine total thickness of the material to be drilled then choose No. 2 or No. 3 point to allow complete drilling. Available in Pan Phillips, Pan Socket and Hex Head.

Order by Stock Number

Standard Package 100 Screws

Stock No.	Dia. x (L)	Drill Point	Max-Metal Drillable (B)	Driver	Stock No.	Dia. x (L)	Drill Point	Max-Metal Drillable (B)	Driver
PAN PHILLIPS HEAD									
232-010	6 x 3/8	#2	.090"	#2	232-020	10 x 1/2	#2	.110"	#2
232-011	6 x 1/2	#2	.090"	#2	232-022	10 x 3/4	#2	.110"	#2
232-013	8 x 1/2	#2	.100"	#2	232-024	10 x 1	#2	.110"	#2
232-015	8 x 3/4	#2	.100"	#2					
PAN SOCKET HEAD									
232-031	6 x 1/2	#2	.090"	#2	232-035	8 x 1	#2	.100"	#2
232-032	8 x 1/2	#2	.100"	#2	232-038	10 x 5/8	#2	.175"	#2
232-034	8 x 3/4	#2	.100"	#2	232-039	10 x 3/4	#2	.175"	#2
HEX WASHER HEAD									
232-071	8 x 1/2	#2	.100"	1/4	232-086	12 x 3/4	#3	.210"	5/16
232-073	8 x 3/4	#2	.100"	1/4	232-088	12 x 1-1/2	#3	.210"	5/16
232-074	8 x 1	#2	.100"	1/4	232-089	12 x 2	#3	.210"	5/16
232-078	10 x 1/2	#2	.110"	5/16	232-092	14 x 3/4	#3	.250"	3/8
232-080	10 x 3/4	#2	.110"	5/16	232-093	14 x 1	#3	.250"	3/8
232-082	10 x 1	#3	.175"	5/16	232-095	14 x 1-1/2	#3	.250"	3/8
232-084	10 x 1-1/2	#3	.175"	5/16	232-097	14 x 2	#3	.250"	3/8

'DRILL-X' MASTER ASSORTMENT No. 020-668

Contains 20 sizes (complete coverage) of 'Papco' Drill-X Self-Drilling Tapping Screws in Pan Socket and Hexagon Washer Head. Packed in a metal box with high-strength plastic compartments. Grease-resistant lid label shows actual size illustrations, measuring chart and retail price codes.





231
Series



**6-LOBE TRIM SCREWS
VIS FINITION 6-LOBE**

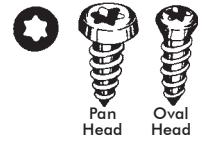

METRIC STAINLESS STEEL TAPPING SCREWS

Used on automotive trim, headlight and tail-light bezels and many other vehicle and appliance applications. The six-lobed drive system improves driver tool life, stops cam-out and increases mechanic's efficiency. These stainless steel screws have Bright Chromium or Black Oxide finish to conform to original specifications.

Order by Stock Number

Standard Package 25 pieces

OVAL TRIM HEAD					PAN HEAD				
Stock No.	Size	Finish	Driver	O.E.M. No.	Stock No.	Size	Finish	Driver	O.E.M. No.
231-205	4.2 x 20mm	Chrome	T-15	11504069	231-251	4.2 x 20mm	Chrome	T-15	11504647
231-206	4.2 x 20mm	Black	T-15	11504659	231-252	4.2 x 20mm	Black	T-15	11504655
231-209	4.2 x 30mm	Chrome	T-15	11504522	231-257	4.2 x 35mm	Chrome	T-15	11504663
231-210	4.2 x 30mm	Black	T-15	11504656	231-264	4.2 x 50mm	Black	T-15	11504774
231-213	4.2 x 40mm	Chrome	T-15	11504654					
231-219	4.2 x 55mm	Chrome	T-15	11504664					

Note: 4.2mm = No. 8 diameter (.164")

**GARAGE ASSORTMENT
No. 020-070**

Contains 70 6-Lobe Oval Head Trim Screws - 6 popular sizes in a clear styrene box.



**GARAGE ASSORTMENT
No. 020-071**

Contains 70 6-Lobe Pan Head Trim Screws - 4 popular sizes in a clear styrene box.

**MASTER ASSORTMENT
No. 020-669**

This assortment contains 240 6-Lobe Trim Screws in both Oval and Pan Heads - 10 popular sizes packed in a sturdy, metal container with handy moulded compartments, an actual size illustrated, grease-resistant lid label - plus a "Papco" T-15 Bull-Dog 6-Lobe driver.



Size: 9-3/4" w. x 13-3/4" l. x 2" d.



**UTILITY ASSORTMENT
No. 020-355**

This handy assortment contains 140 6-Lobe Trim Screws in both Oval and Pan Heads - 10 popular sizes packed in a sturdy fibre-board container complete with actual size illustrated, grease-resistant lid label.

231
Series



**6-LOBE BULL-DOG DRIVERS
TOURNEVIS 6-LOBE**

Specially designed to be used with 6-Lobe screws, these drivers feature a 1-3/16" diameter heavy-duty, Bull-Dog handle. These professional quality tools permit greater torque and offer a more comfortable grip than regular drivers.

8-1/2" Overall Length - 4-1/2" Handle Length.

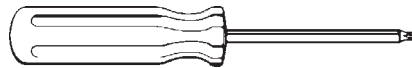

Order by Stock Number

Individually Carded

Stock No.	Stock No.	Stock No.	Stock No.	Stock No.	Stock No.	Stock No.	Stock No.
231-980	231-981	231-982	231-983	231-984	231-985	231-986	
T-8	T-10	T-15	T-20	T-25	T-27	T-30	T-40
6-Lobe Bits with 1/4" shank		231-992	231-993	231-994		231-996	231-998

For 6 in 1 6-LOBE Magnetic Screwdriver see page 73.

3000
Series

papeo

TAPCON® CONCRETE SCREWS
VIS A BETON `TAPCON®`



- NO PLUGS
- JUST DRILL AND DRIVE

Ideal for concrete, brick or hollow block. Shear strength: 3/16" dia. = 145lbs, 1/4" dia. = 285lbs. Using the correct Tapcon Bit, drill hole in masonry to depth of at least 1/4" deeper than installed screw.

NOTE: DO NOT USE BIT TO DRILL STEEL FIXTURES. Position Tapcon through fixture and drive into pre-drilled hole until seated. The Condrive Installation Tool is available for repetitive installations.

Genuine Blue Zinc Dichromate Plated

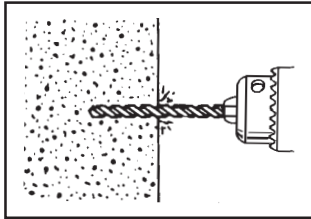
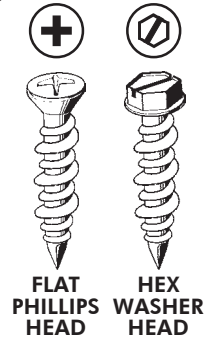

DRILL

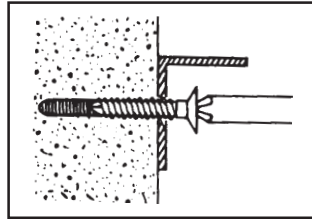

DRIVE

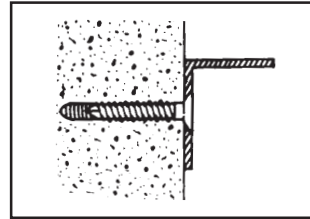

INSTALLED

Order by Stock Number

Standard Package 100 Screws (Includes Tapcon Drill Bit)

3/16 Diameter				1/4 Diameter			
Phillips Stock No.	Hex Stock No.	Size	Tapcon Drill Size	Phillips Stock No.	Hex Stock No.	Size	Tapcon Drill Size
3110	3010	3/16 x 1-1/4	5/32 x 3-1/2	3310	3210	1/4 x 1-1/4	3/16 x 3-1/2
3120	3020	3/16 x 1-3/4	5/32 x 3-1/2	3320	3220	1/4 x 1-3/4	3/16 x 3-1/2
3130	3030	3/16 x 2-1/4	5/32 x 4-1/2	3330	3230	1/4 x 2-1/4	3/16 x 4-1/2
3140	3040	3/16 x 2-3/4	5/32 x 4-1/2	3340	3240	1/4 x 2-3/4	3/16 x 4-1/2
3160	3060	3/16 x 3-1/4	5/32 x 5-1/2	3350	3250	1/4 x 3-1/4	3/16 x 5-1/2
				3370	3270	1/4 x 4	3/16 x 5-1/2

Tapcon® is a registered Trademark of ITW Buildex

papeo CONDRIVE INSTALLATION TOOL OUTIL `CONDRIVE` D`INSTALLER No. 7000

For repetitive installation of `Tapcon` Concrete Screws

The Condrive 7000 is a multi-purpose installation tool that is inserted into a 3/8 or 1/2 inch chuck of a standard hammer or electric drill. The Condrive 7000 Tool can be set up to drive either Hex or Phillips drive Tapcon Screws.

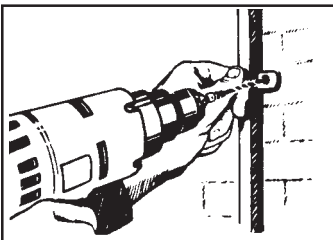
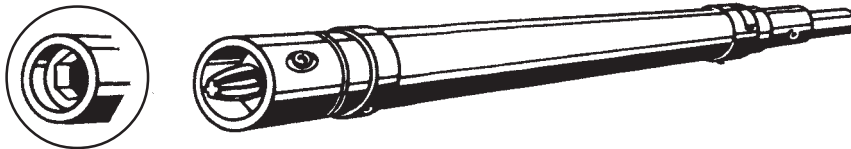

1. Insert drill adapter with drill bit into chuck of electric drill. Drill hole into masonry 1/4" deeper than installed screw.

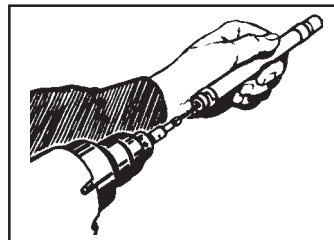

2. Place Hex or Phillips driver bit into tool. Slide end of tool sleeve over drill bit and snap onto drill adaptor.

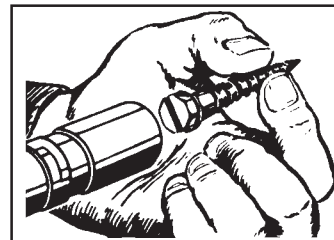

3. Insert head of Tapcon Concrete Screw into Hex or Phillips driver bit. Install screw through fixture into pre-drilled hole until seated.



3400
Series

papco

'DYNABOLT®' SLEEVE ANCHORS
ANCRES A DOUILLE 'DYNABOLT®'

- ZINC PLATED CARBON STEEL • MEDIUM DUTY CONCRETE OR MASONRY ANCHORS

'Papco' Sleeve Anchors can be used in cement block, thin wall or solid concrete, brick or stone. Ideal for anchoring partitions, cabinets, shelves, fire extinguishers, duct work, electrical systems, heating units etc. Drill hole same size as diameter of anchor to any depth exceeding minimum embedment. Clean hole of dust after drilling. Insert anchor through fixture and tighten nut with wrench 2-3 turns. Length is measured from washer to end of anchor.

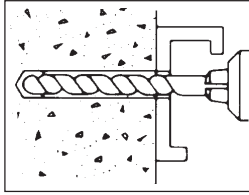
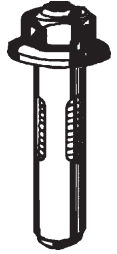

DRILL

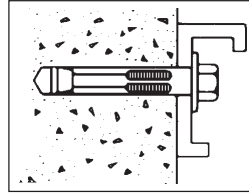

INSTALL

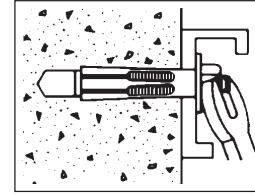

TIGHTEN

Order by Stock Number

For Masonry Drill Bits see page 176.

Stock No.	Dia. x Length	Min. Embed.	Max. Mat. Thick.	Std. Pkg.	Ultimate Load Capacity*		Use Drill Bit No.
					LOAD lbs.	SHEAR lbs.	
3400	1/4 x 1-3/8	1-1/8	1/4	100	1613	1751	997-587
3405	1/4 x 2-1/4	1-1/8	1-1/8	20	1613	1751	997-587
3410	5/16 x 1-1/2	1-1/4	1/4	100	2429	2487	997-588
3415	5/16 x 2-1/2	1-1/4	1-1/4	20	2429	2487	997-588
3420	3/8 x 1-7/8	1-1/2	3/8	50	2597	2872	997-589
3425	3/8 x 3	1-1/2	1-1/2	25	2597	2872	997-589
3430	1/2 x 2-1/4	1-7/8	3/8	10	5385	5582	997-590
3435	1/2 x 3	1-7/8	1-1/8	10	5385	5582	997-590
3440	1/2 x 4	1-7/8	2-1/8	10	5385	5582	997-590

* Ultimate load capacity in 4000 p.s.i. 3/4 inch crushed limestone aggregate concrete for depth of embedment indicated. Safe working loads should not exceed 25% of ultimate load capacity for single installations under static loading.

5000
Series

papco

'TRUBOLT®' WEDGE ANCHORS
ANCRES DE CALAGE 'TRUBOLT®'

- ZINC PLATED CARBON STEEL • HEAVY-DUTY CONCRETE ANCHORS

'Papco' Heavy-duty Wedge Anchors are ideal for anchoring electrical, heating, ventilating, plumbing and air conditioning systems - storage racks, machinery mounting, highway rails, guards and posts in concrete. Each anchor is assembled with a stainless steel expansion clip providing high corrosion resistance and is fully threaded for varying material thicknesses. Drill hole same size as diameter of anchor to any depth exceeding concrete embedment. Clean hole of dust after drilling. Insert anchor through fixture and tighten nut 3-5 turns. Length is measured from washer to end of anchor.

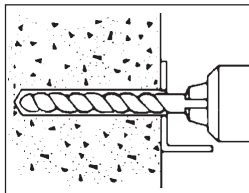
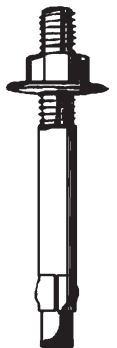

DRILL

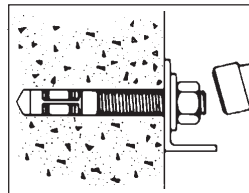

INSTALL

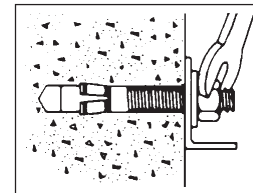

TIGHTEN

Order by Stock Number

Stock No.	Dia. x Length	Concrete Embed.	Max. Mat. Thick.	Std. Pkg.	Ultimate Load Capacity*		Use Drill Bit No.
					LOAD lbs.	SHEAR lbs.	
5005	1/4 x 2-1/4	1-15/16	7/8	25	2999	1910	997-587
5015	3/8 x 2-1/4	1-1/2	3/8	50	3219	4029	997-589
5020	3/8 x 2-3/4	1-1/2	7/8	40	3219	4029	997-589
5025	3/8 x 3	3	1-1/8	30	5678	4305	997-589
5030	3/8 x 3-3/4	4-1/2	1-7/8	25	5935	4581	997-589
5055	1/2 x 3-3/4	2-1/4	1-1/8	15	5384	6900	997-590
5060	1/2 x 4-1/4	4-1/8	1-1/2	10	7333	7449	997-590
5065	1/2 x 5-1/2	6	2-3/4	10	9003	7998	997-590

* Ultimate load capacity in 4000 p.s.i. stone aggregate for the depth of embedment indicated. Safe working loads should not exceed 25% of ultimate load capacity for single installations under static loading. 'Dynabolt' and 'Trubolt' are registered trademarks of ITW Buildex.

239
Series

papeco BLIND RIVETS RIVETS OBTURATEURS

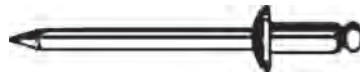

Fasten joints without access to reverse side. Insert rivets - the retracting jaws in the setting tool pull the mandrel head into the rivet body on the reverse side until the mandrel breaks. The high clinch action pulls the parts together for a tight, vibration-proof fastening.

Standard Packages: 1/8" and 5/32" dia. 500 rivets; 3/16" dia. 250 rivets; Stainless Steel 100 rivets. Most popular sizes available in 50 Rivets per convenient hang-up boxes.
*25 per hang-up box.

HOW TO MEASURE RIVETS

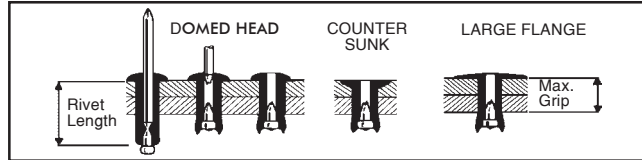
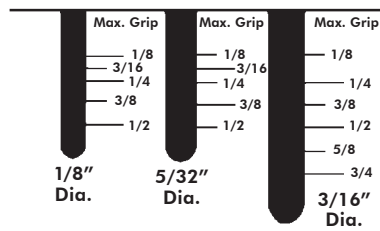

Rivet Diameter		Drill	
Inch	Metric	Number	Size
3/32	2.4mm	#41	.096 - .100
1/8	3.2mm	#30	.129 - .133
5/32	4.0mm	#20	.160 - .164
3/16	4.8mm	#11	.192 - .196

Rivet Length measure to end of rivet body.
Recommended Hole Sizes

Order by Stock Number

Stock No.	Other No.	Hang-up Box No.	Rivet Dia.	Grip Range	Head Type	Rivet Length	
ALUMINUM RIVET - ALUMINUM MANDREL							
239-011	AA42D	239-611	1/8 (.125)	1/16 - 1/8	Domed	.232	
239-014	AA43D	239-614		1/8 - 3/16	Domed	.294	
239-017	AA44D	239-617		3/16 - 1/4	Domed	.357	
239-018	AA44LF	-		3/16 - 1/4	L. Flange	.357	
239-023	AA46D	-		5/16 - 3/8	Domed	.481	
239-026	AA48D	-		3/8 - 1/2	Domed	.625	
239-038	AA56D	-	5/32 (.156)	1/4 - 3/8	Domed	.504	
239-047	AA62D	*239-647		3/16 (.188)	1/16 - 1/8	Domed	.277
239-053	AA64D	*239-653			1/8 - 1/4	Domed	.402
239-056	AA66D	-		1/4 - 3/8	Domed	.527	
239-057	AA66LF	-		1/4 - 3/8	L. Flange	.527	
239-059	AA68D	-		3/8 - 1/2	Domed	.652	
239-060	AA68LF	-	3/8 - 1/2	L. Flange	.652		
ALUMINUM RIVET - STEEL MANDREL							
239-111	AS42D	239-711	1/8 (.125)	1/16 - 1/8	Domed	.232	
239-114	AS43D	239-714		1/8 - 3/16	Domed	.294	
239-117	AS44D	239-717		3/16 - 1/4	Domed	.357	
239-150	AS62D	*239-750	3/16 (.188)	1/16 - 1/8	Domed	.277	
239-153	AS64D	*239-753		1/8 - 1/4	Domed	.402	
239-156	AS66D	-		1/4 - 3/8	Domed	.527	
239-159	AS68D	-		3/8 - 1/2	Domed	.652	
239-160	AS68LF	-		3/8 - 1/2	L. Flange	.652	
STEEL RIVET - STEEL MANDREL							
239-210	SS42C	239-810	1/8 (.125)	1/16 - 1/8	Csk.	.276	
239-211	SS42D	239-811		1/16 - 1/8	Domed	.232	
239-213	SS43C	239-813		1/8 - 3/16	Csk.	.316	
239-214	SS43D	239-814		1/8 - 3/16	Domed	.294	
239-216	SS44C	239-816		3/16 - 1/4	Csk.	.362	
239-217	SS44D	239-817		3/16 - 1/4	Domed	.357	
239-218	SS44LF	-	3/16 - 1/4	L. Flange	.357		
239-223	SS46D	-	5/32 (.156)	5/16 - 3/8	Domed	.481	
239-226	SS48D	-		3/8 - 1/2	Domed	.625	
239-229	SS52D	-		1/16 - 1/8	Domed	.254	
239-235	SS54D	-			3/16 - 1/4	Domed	.397
239-238	SS56D	-		1/4 - 3/8	Domed	.504	
239-250	SS62D	*239-850		3/16 (.188)	1/16 - 1/8	Domed	.277
239-253	SS64D	*239-853	1/8 - 1/4		Domed	.402	
239-256	SS66D	-	1/4 - 3/8		Domed	.527	
239-257	SS66LF	-	1/4 - 3/8		L. Flange	.527	
239-259	SS68D	-	3/8 - 1/2		Domed	.652	
239-260	SS68LF	-	3/8 - 1/2		L. Flange	.652	
239-262	SS610D	-	3/16 (.188)	1/2 - 5/8	Domed	.777	
239-263	SS610LF	-		1/2 - 5/8	L. Flange	.777	
239-265	SS612D	-		5/8 - 3/4	Domed	.902	
239-266	SS612LF	-		5/8 - 3/4	L. Flange	.902	
STAINLESS RIVET - STEEL MANDREL							
5195-111	STS42D	-		1/8 (.125)	1/16 - 1/8	Domed	.232
5195-114	STS43D	-	1/8 - 3/16		Domed	.294	
5195-117	STS44D	-	3/16 - 1/4		Domed	.357	
5195-123	STS46D	-	5/16 - 3/8		Domed	.481	
5195-126	STS48D	-	3/8 - 1/2		Domed	.625	
5195-150	STS62D	-	3/16 (.188)		1/16 - 1/8	Domed	.277
5195-153	STS64D	-		1/8 - 1/4	Domed	.402	
5195-156	STS66D	-		1/4 - 3/8	Domed	.527	
5195-159	STS68D	-		3/8 - 1/2	Domed	.652	
STAINLESS RIVET - STAINLESS MANDREL							
5195-211	STST42D	-		1/8 (.125)	1/16 - 1/8	Domed	.232
5195-214	STST43D	-	1/8 - 3/16		Domed	.294	
5195-217	STST44D	-	3/16 - 1/4		Domed	.357	
5195-223	STST46D	-	5/16 - 3/8		Domed	.481	
5195-226	STST48D	-	3/8 - 1/2		Domed	.625	
5195-250	STST62D	-	3/16 (.188)		1/16 - 1/8	Domed	.277
5195-253	STST64D	-		1/8 - 1/4	Domed	.402	
5195-256	STST66D	-		1/4 - 3/8	Domed	.527	
5195-259	STST68D	-		3/8 - 1/2	Domed	.652	



239
Series

papco® HAND RIVETERS RIVETEUSE MANUELLE

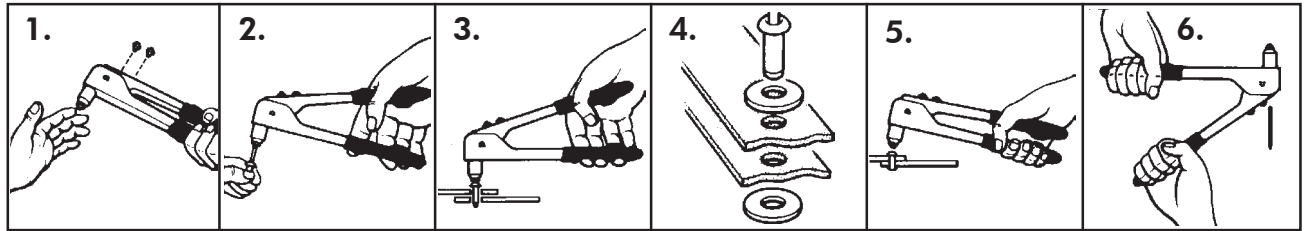

1. Drill a hole of the recommended size in each of the parts to be riveted and select correct nose-piece.

2. Fully open handles. Insert rivet until head touches nose-piece.

3. Insert rivet in the hole.

4. For soft materials or oversize holes use back-up plates to eliminate rivet pull-through.

5. Squeeze handles together. If mandrel does not break, open handles, push rivet head back to nose-piece and repeat until mandrel breaks.

6. Hold riveter with nose-piece up. Fully open handles and snapped off stem will fall out.

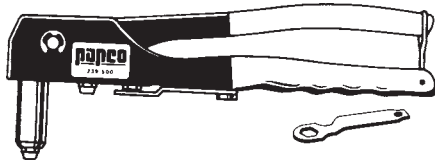

No. 239-500 MEDIUM DUTY BLIND RIVETER

An economical tool for medium duty. Vinyl grips on stamped long handles for extra leverage with milled steel nose. Sets 3/32", 1/8", 5/32" and 3/16" dia. aluminum rivets.

Individually packaged.

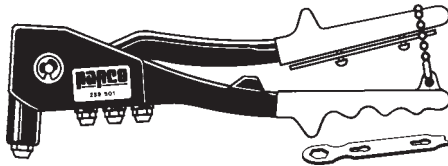

No. 239-501 PROFESSIONAL SERVICE BLIND RIVETER

Sturdy, fast acting tool. Will set 3/32", 1/8", 5/32" and 3/16" dia. rivets. Capacity 3/16" aluminum. Moulded contour hand grips and long forged handles for extra leverage. Complete with four nose-pieces.

Heavy Duty

Individually packaged.



No. 400-002 CERAMIC BLOCK MAGNETS

'Papco' High Strength Ceramic Block Magnets are ideal for temporary attachment of metal panels, work orders or masking material without damaging painted areas or other metal surfaces. Each skin-packed card contains two block magnets. Each magnet is 7/8" wide x 1-7/8" long x 3/8" thick.

For other Magnet products see page 148.



BLIND RIVET MASTER ASSORTMENT No. 020-667

Contains 1200 pieces - 10 popular sizes of Aluminum and Steel Domed Head Rivets and 3 sizes of Back-up Plates. Packed in a sturdy metal container with handy moulded compartments and an actual size illustrated grease-resistant lid label.

Size: 9-3/4" w. x 13-3/4" l. x 2" d.

239
Series

papco® MULTI-GRIP BLIND RIVETS RIVETS OBTURATEURS MULTI-GRIP

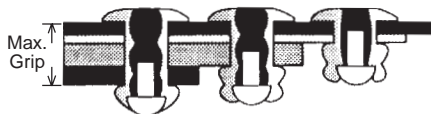

and soft materials needs fastening. Compensates for hole size and alignment variations. Aluminum body and steel mandrel. Domed head. Order by Stock Number.

These blind rivets cover the grip range of three standard rivets. Excellent where a combination of hard



Standard Package 100 rivets.

Stock No.	Other No.	Rivet Dia.	Grip Range	Rivet Length
239-314	AD41-43	1/8 (.125)	.031-.185	.315
239-320	AD43-45	1/8 (.125)	.157-.335	.480
239-335	AD52-54	5/32 (.156)	.047-.248	.425
239-353	AD62-64	3/16 (.187)	.063-.252	.414

papco BACK-UP PLATES



239-493
239-494
239-492

Back-up plates for 1/8" dia. Rivets (9/64 x 3/8 x 1/32) Plated Steel, 100 per box.
Back-up plates for 3/16" dia. Rivets (13/64 x 1/2 x 3/64) Plated Steel, 100 per box.
Back-up plates for 3/16" dia. Rivets (13/64 x 1/2 x 3/64) Aluminum, 100 per box.

247
Series

papco

PLASTIC RIVETS
RIVETS EN PLASTIQUE



'Papco' Plastic expansion rivets are used to fasten panels, fascia strips, inner fenders, grilles, shields etc. Moulded of nylon, the three leg design draws panels tightly together as the mandrel breaks off.

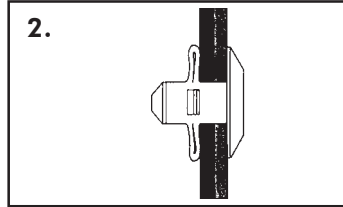
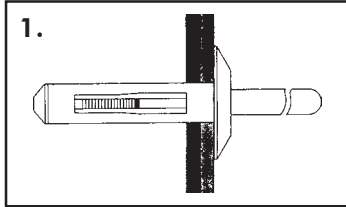

Order by Stock Number

Illustrations Actual Size

Standard Package 25 pieces.

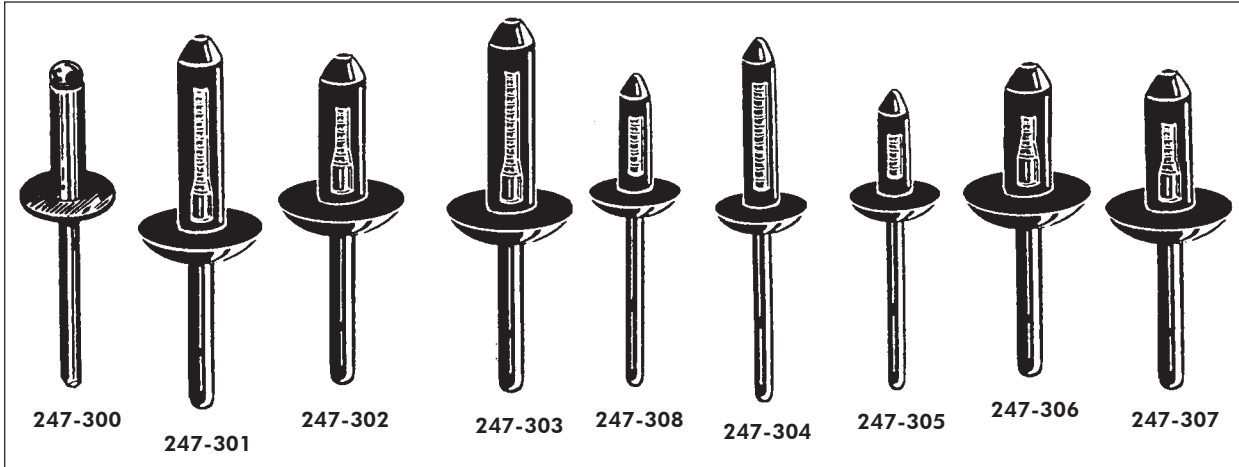

Stock No.	Factory No.	Rivet Dia.	Max. Grip	Head Flange Dia	Drill Size
247-300	Chrysler: 6500899, GM: 2043297 VW: 175-853-57701C	5mm	6mm	12mm	7/32
247-301	Chrysler: 6500911 Ford: N803043-S GM: 14063981	6.3	10	17	1/4
247-302	GM: 14070914 (White)	6.3	6	17	1/4
247-303	Ford: N803862-S GM: 20452072	6.3	10	13	
247-304	GM: 20433026 VW: 175-853-577A	6.6	5	17	9/32
247-305	GM: 20421672	6.6	5	13	9/32
247-306	Ford: N804189S, GM: 2042367	5	4.5	12	7/32
247-307	Chrysler: 6500898	5	10	12	7/32
247-308	388664-S100 (Black) Ford Fascia & Bumper (Aluminum)	3/16"	1/2"	9/16"	—

For 'Papco' Plastic Rivets Master Assortment No. 020-693 see page 8.

papco

PLASTIC RIVET
SETTING TOOL

No. 247-330

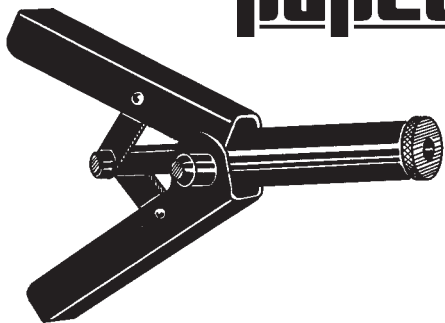

This sturdy steel tool sets all sizes of plastic rivets. The long reach gets into tight areas and the extra leverage allows fast, one-stroke setting. Used with Plastic Rivets above.

Order by Stock Number

Individually packaged.



239
Series

PAPCO BLIND WELL NUTS ECROUS Puits OBTURATEURS

Consists of a flanged neoprene bushing with a captive brass insert nut. As the screw is tightened the bushing expands making a secure fastening in thin sheet metal or blind holes. Use to mount accessories on cars, vans, trucks, snowmobiles, fiberglass boats etc.

Order by Stock Number Standard Package 10 Nuts

Stock No.	Thread Size	Hole Size	Panel Thick. Max.	Flange Dia.	Shank Length
239-974	6-32	5/16	.156"	.462"	.437"
239-976	8-32	5/16	.156	.438	.447
239-985	10-32	3/8	.227	.750	.620
239-991	1/4-20	1/2	.187	.250	.642

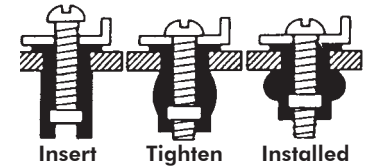

PAPCO MIRROR MOUNTING 'JACK' NUT No. 239-960

Made of 1010 Zinc Plated Steel this 1/4-20 Jack Nut with sealer has been designed for mounting outside mirrors to body panels. Legs of nut expand as screw is driven providing a positive, water-tight connection. Used with 'Papco' Body Bolt No. 245-610 on page 92. May also be used to attach licence plates.

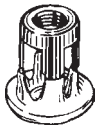

Standard Package 25 Pieces

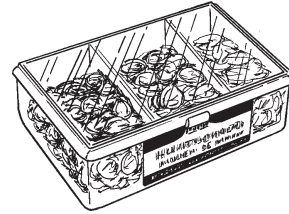

BLIND WELL NUT GARAGE ASSORTMENT No. 020-081

Contains 20 nuts in 6-32, 8-32, 10-32, and 1/4-20. Packed in a clear plastic box.

222
Series

PAPCO 'SERT - A - NUTS' ECROUS D'ANCRAGE

'Papco' Aluminum 'Sert-a-Nuts' may be used in sheet metal, plastic, castings, fiberglass, or any rigid material. 'Sert-a-Nut' has an unlimited grip range and no thickness barrier. Eliminates the need for tapping, welding or brazing. Kits include Setting Tool, Socket Screw and Hex Key.

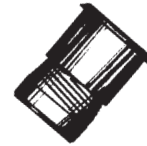

<p>1.</p> <p>Place screw through tool and thread into 'Sert-a-Nut' flange side up</p>	<p>2.</p> <p>Insert 'Sert-a-Nut' into pre-drilled hole</p>	<p>3.</p> <p>Hold tool with wrench, turn screw with key until tight</p>	<p>4.</p> <p>'Sert-a-Nut' is now anchored solidly into hole</p>
---	--	---	---

Order by Stock No.

'SERT-A-NUTS'

Stock No.	Size	Drill	Std. Pkg.
222-304	6-32	7/32	25
222-306	8-32	1/4	25
222-308	10-24	9/32	25
222-310	1/4-20	3/8	25

'SERT-A-NUT' KITS

Stock No.	Size	Drill	Ins. per Kit
222-314	6-32	7/32	5
222-316	8-32	1/4	5
222-318	10-24	9/32	5
222-320	1/4-20	3/8	5

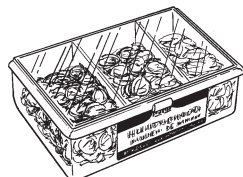

'SERT - A - NUT' GARAGE ASSORTMENT No. 020-090

Contains 4 complete kits for 6-32, 8-32, 10-24 and 1/4-20 'Sert-a-Nuts'.

Four sizes in a clear plastic box.

239
Series

papco

WELD PINS
GOUPILLES A SOUDER



'Papco' Steel Weld Pins (Copper Plated) are used extensively for removing dents in quarter panels, fenders, doors etc. Pins are welded in place then dents are pulled out by using a gripping tool to pull dent out of damaged body panel area. Pins are then ground off. Copper Plated for increased conductivity.



Order by Stock No.

Standard Package 100 Pieces

Stock No.	Size	Stock No.	Size
239-900	2 mm (.080") Dia. x 2" Long	239-901	2.5 mm (.098") Dia. x 2" Long

Bulk quantities available - price on application.

240
Series

papco

FLAT TYPE SPEED NUTS
ECROUS TENIR TYPE FRAISSE

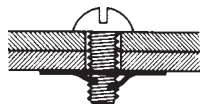





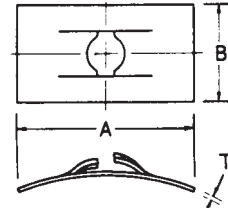



Flat Type

Used with machine screws and sheet metal screws. One piece, heat treated spring steel self-locking fastener. The original equipment fastener used on headlights, radiators, moulding, trim, gravel deflectors, ornaments, emblems, name plates, etc.



Order by Stock Number

Standard Package contains 100 Speed Nuts

			
240-089 6-32 Screw	240-091 6-32 Screw	240-100 8-32 Screw	240-101 8-32 Screw
			
240-120 10-24 Screw	240-159 1/4"-20 Screw	240-108 No. 8 Screw	240-127 No. 10 Screw

Actual Size Illustrations

Stock No.	Screw Size	Dimensions A x B x T	Other No.	Application
240-089	6-32	1/2 x 5/16 x .017	2089	General Purpose.
240-091	6-32	7/8 x 1/2 x .017	1898	Chrysler prod. garish moulding ornament.
240-100	8-32	1/2 x 5/16 x .017	2091	General Purpose.
240-101	8-32	7/8 x 1/2 x .017	1899	Chrysler prod. rad and trunk medallion.
240-120	10-24	3/4 x 7/16 x .022	2092	General Purpose.
240-159	1/4-20	1" x 9/16 x .027	1903	General Purpose.
240-108	No. 8	5/8 x 11/32 x .031	3793	For sheet metal screws.
240-127	No. 10	7/8 x 1/2 x .031	1900	For sheet metal screws, and rad. grille.

SPEED NUT
GARAGE ASSORTMENT No. 020-015

Contains 8 sizes of Flat Type Speed Nuts, 160 pieces. Packed in handy, clear plastic box, with moulded compartments.





240
Series

papeco

FORMED TYPE SPEED NUTS
ECROUS TENIR TYPE FORME

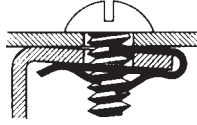

'J' Types



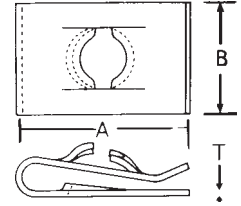









Used with Machine Screws and Sheet Metal Screws. Two types, 'U' and 'J'. Press into locked on position over panel edge or in centre-panel location. Holds itself in screw receiving position.



'U' Types

Order by Stock Number

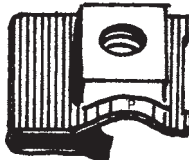
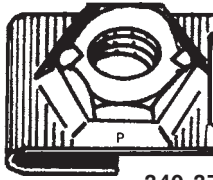
Standard Package contains 100 Speed Nuts

 240-243 10-24 Screw	 240-263 1/4"-20 Screw	 240-226 No. 8 Screw	 240-228 No. 8 Screw	 240-232 No. 8 Screw
 240-242 No. 10 Screw	 240-247 No. 10 Screw	 240-250 No. 10 Screw	 240-266 No. 12 Screw	 240-267 No. 14 Screw
 240-268 No. 14 Screw	 240-274 1/4"-20 Screw	 240-276 5/16"-18 Screw	 240-278 3/8"-16 Screw	

Actual Size Illustrations

Stock No.	Screw Size	Type	Dimensions			Other No.	Application
			A	x B	x T		
240-243	10-24	U	41/64	x 7/16	x .020	5197	General Purpose.
240-263	1/4-20	U	63/64	x 1/2	x .025	2293	License Plate attaching nut.
FOR SHEET METAL SCREWS							
240-226	No. 8	U	31/64	x 1/2	x .028	3796	Chev. Headlamp adj. nut, Rad. grille assembly.
240-228	No. 8	U	41/64	x 7/16	x .028	10666	Ford quarter trim to panel.
240-232	No. 8	U	3/4	x 7/16	x .029	11292	General Purpose.
240-242	No. 10	J	1"	x 1/2	x .035	8341	General Purpose.
240-247	No. 10	J	15/32	x 11/16	x .031	2303	Chevrolet Headlamp to fender.
240-250	No. 10	U	3/4	x 1/2	x .031	2422	Ford radiator grille.
240-266	No. 12	U	7/8	x 9/16	x .034	1910	General Purpose.
240-267	No. 14	J	7/8	x 9/16	x .034	2420	Olds. front fender rad. to grille 3/32" panel.
240-268	No. 14	J	7/8	x 9/16	x .034	2057	Olds. Pontiac, fender and rad. 3/64" panel.
240-274	1/4-20	J	7/8	x 5/8	x .300	5586	General Purpose 'J' Type Cage Nut
240-276	5/16-18	J	1-1/16	x 3/4	x .300	5589	General Purpose 'J' Type Cage Nut
240-278	3/8-16	J	1-1/8	x 3/4	x .300	5170	General Purpose 'J' Type Cage Nut

SPEED NUT
GARAGE ASSORTMENT No. 020-016

Contains 8 sizes of 'U' and 'J' Formed Type Speed Nuts, 65 pieces. Packed in handy, clear plastic box with compartments.





240
Series

papeco

**PUSH-ON TYPE SPEED NUTS
ECROUS TENIR TYPE POUSEE**

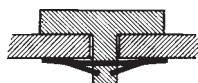



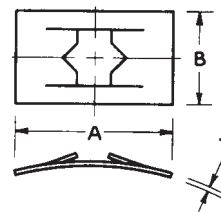







For use on studs, rivets and other unthreaded parts. Teeth bite inward and arched shape provides secure spring grip.



Push-On Type

Order by Stock Number

Standard Package contains 100 Speed Nuts

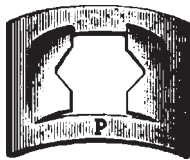
 240-310 1/16" Stud	 240-320 3/32" Stud	 240-325 .100 Stud	 240-331 1/8" Stud
 240-335 1/8" Stud	 240-340 5/32" Stud	 240-345 5/32" Stud	 240-350 3/16" Stud
 240-355 1/4" Stud	 240-365 5/16" Stud	 240-370 3/8" Stud	

Actual Size Illustrations

Stock No.	Screw Size	Dimensions				Other No.	Application	
		A	x	B	x			T
240-310	1/16	25/64	x	7/32	x	.012	2098	Buick seat trim, Chrysler name plate.
240-320	3/32	7/16	x	7/32	x	.017	2100	For Hardened Studs, Pontiac name plate.
240-325	.100	29/64	x	15/64	x	.014	1906	General Purpose.
240-331	1/8	3/8	x	11/32	x	.019	3559	General Purpose.
240-335	1/8	37/64	x	5/16	x	.012	2099	General Purpose.
240-340	5/32	3/4	x	7/16	x	.020	1905	General Purpose.
240-345	5/32	9/16	x	3/8	x	.012	2102	General Purpose.
240-350	3/16	5/8	x	3/8	x	.017	2103	Ford products name plate, ornament.
240-355	1/4	41/64	x	7/16	x	.017	2105	General Purpose.
240-365	5/16	3/4	x	17/32	x	.020	3138	General Purpose.
240-370	3/8	13/16	x	5/8	x	.020	3139	General Purpose.

**SPEED NUT
GARAGE ASSORTMENT No. 020-017**

Contains 7 sizes of Push-On Type Speed Nuts, 160 pieces. Packed in a rigid clear plastic container with handy compartments.





240
Series

papco® TUBULAR TYPE SPEED CLIPS ECROUS TENIR TYPE A TUBE

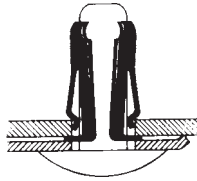





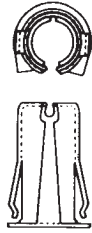

Tubular Type

Used on unthreaded studs and rivets where there is access to only one side of the assembly. Insert Speed Clips into hole causing cam-like side prongs to snap and hold clip in proper position. Push rivet end into clip causing turned-in end of clip to bite rivet and lock it securely.



Order by Stock Number

Standard Package contains 100 Speed Clips

Actual Size Illustrations					
					
240-430 1/8" Stud	240-431 1/8" Stud	240-432 1/8" Stud	240-469 5/32" Stud	240-471 3/16" Stud	240-472 3/16" Stud
Stock No.	Stud Dia.	Panel Range	Fits Hole	Other No.	Factory No.
240-430	1/8	.030" - .036"	5/32	2611	—
240-431	1/8	.040" - .045"	3/16	2595	—
240-432	1/8	.036" - .046"	1/4	5195	3783794
240-469	5/32	.062" - .068"	7/32	8545	—
240-471	3/16	.038" - .044"	7/32	10073	6000558
240-472	3/16	17/64 Barrel Length	17/64	13966	8934-201-767

SPEED NUT GARAGE ASSORTMENT No. 020-018

Contains 6 sizes of Tubular Speed Clips, for studs, 70 pieces. Packed in clear plastic container with easy to use compartments.



papco® Speed Nut UTILITY ASSORTMENTS

020-315



FLAT TYPE

8 sizes for Machine and Sheet Metal Screws, 325 pieces.

020-316



FORMED TYPE

10 sizes, 'U' and 'J' types for Machine and Sheet Metal Screws, 110 pieces.

020-317



PUSH-ON and TUBULAR

14 sizes for unthreaded Studs, 275 pieces.

All 'Papco' Utility Assortments are packed in sturdy fibreboard metal-edged boxes with individual compartments and with illustrated labels showing parts and prices.

papeo® Speed Nut MASTER ASSORTMENTS



MASTER ASSORTMENT No. 020-643

FOR UNTHREADED STUDS

Contains 7 Sizes Tubular Speed Clips
14 Sizes Push-On Speed Nuts
467 pieces selected according to popularity.

Name plates, emblems, moulding clips are held with Tubular Speed Clips and Push-on Speed Nuts. These kits will service every need that will come up in your shop.



MASTER ASSORTMENT No. 020-644 FOR MACHINE and SHEET METAL SCREWS

Contains 12 Sizes Flat Type Speed Nuts,
14 Sizes Formed Type Speed Nuts
421 pieces balanced for popularity.

Every year more and more Speed Nuts are used for Original Equipment attachments. These handy kits contain the Speed Nuts that are most frequently replaced on all makes of cars.



Size: 9-34" w. x 13-3/4" l. x 2" d.

papeo SUPER SERVICE ASSORTMENT No. 020-810

SPEED NUT

SUPER-SERVICE ASSORTMENT No. 020-810

- Contains 685 Speed Nuts in Flat, Push-on and Formed Types – 32 sizes.
- Large size, rigid metal box with high-strength plastic compartments.
- Convenient, safety snap carrying handle.
- Actual size illustrations and retail codes of every item shown on grease-resistant lid label.
- Refills available in standard packages.

Ideal for Dealers, Jobbers and large users. This popular assortment contains a wide range of Flat Push-on and Formed Type Speed Nuts carefully



selected in balanced quantities.

Size: 12" w. x 18" l. x 3" d.

papeo SUPER SERVICE ASSORTMENT No. 020-823

Contains 325 'U' Nuts and Body Bolts – 22 items.

Large size, rigid metal box with high-strength plastic compartments.

For more details see page 9.

Large size: 12" w. x 18" l. x 3" d.

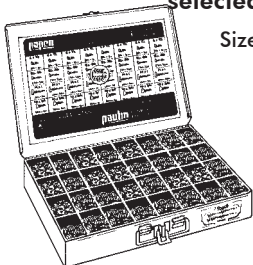



papeco 'PALNUT' LOCK NUTS ECROUS 'A BLOCAGE 'PALNUT'

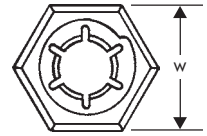

242
Inch

REGULAR TYPE
BRIGHT ZINC PLATED

243
Metric

Spring steel, single thread lock nuts. May be used alone or on top of ordinary nuts.

Order by Stock Number Standard Package 50 pieces

INCH			METRIC		
Stock No.	Size & Thread	Across Flats 'W'	Stock No.	Size	Across Flats 'W'
242-016	5/16-24	1/2"	243-004	M4	9mm
242-018	3/8-24	9/16"	243-005	M5	13mm
242-020	7/16-20	5/8"			
242-022	1/2-20	3/4"			

HEX WASHER TYPE BRIGHT ZINC PLATED

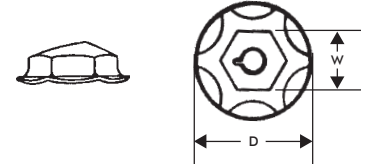

Integral washers on these lock nuts span slots or clearance holes. This spring locking action of the washer provides a secure assembly.

Order by Stock Number Standard Package 50 pieces

INCH			METRIC		
Stock No.	Size & Thread	'W' x 'D'	Stock No.	Size	'W' x 'D'
242-108	8-32	11/32 x 5/8	243-105	M5	10mm x 13mm
242-110	10-24	3/8 x 3/4	243-106	M6	11mm x 18mm
242-114	1/4-20	7/16 x 11/16			
242-116	5/16-18	1/2 x 13/16			

GARAGE ASSORTMENT No. 020-074

Contains 100 pieces of all Inch sizes of Palnut Lock Nuts both regular and washer types. Packed in a sturdy, plastic box.

GARAGE ASSORTMENT No. 020-075

Contains 100 pieces of all Metric size Palnut Lock Nuts in both regular and washer types. Packed in a clear, plastic box.



papeco SELF-THREADING 'PALNUTS' 'PALNUTS' A FILETAGE COUPANT

These washer base, heat treated nuts cut their own threads on plain studs, nameplates, ornaments and mouldings. The mastic sealer type protects against dirt and moisture.

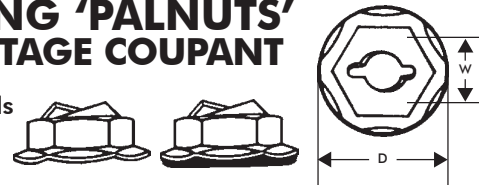

Order by Stock Number

BRIGHT ZINC PLATED

Standard Package 50 pieces

Stock No.	Stud Size	Type	'W' x 'D'	Stock No.	Stud Size	Type	'W' x 'D'
242-206	1/8	Regular	5/16 x 7/16	242-210	3/16	Regular	3/8 x 1/2
242-207	1/8	Sealer	5/16 x 7/16	242-211	3/16	Sealer	3/8 x 1/2
242-208	5/32	Regular	11/32 x 9/16	242-214	1/4	Regular	7/16 x 11/16
242-209	5/32	Sealer	11/32 x 9/16	242-215	1/4	Sealer	7/16 x 11/16
				242-216	5/16	Regular	1/2 x 7/8

papeco METRIC SELF-THREADING 'PALNUTS' 'PALNUTS' A FILETAGE COUPANT METRIQUE

Order by Stock Number

BRIGHT ZINC PLATED

Standard Package 50 pieces

Stock No.	Stud Size	Type	'W' x 'D'	Stock No.	Stud Size	Type	'W' x 'D'
243-204	4mm	Regular	9mm x 15mm	243-205	5mm	Regular	10mm x 15mm

SELF-THREADING 'PALNUT' GARAGE ASSORTMENT No. 020-052

Contains 100 nuts of 1/8, 5/32, 3/16, 1/4 and 5/16 Self-Threading Palnuts in both Regular and Sealer types. Packed in a clear, plastic box.



242
Inch

243
Metric

papeco BOLT RETAINERS RETENUE DE BOULON



BLACK PHOSPHATE FINISH

These fasteners are pushed onto a screw or bolt of either coarse or fine thread to hold it in place during assembly. When the regular nut is tightened the retainer is left in place.

Order by Stock Number

Standard Package 100 Pieces

INCH			METRIC		
Stock No.	Screw or Bolt Dia.	Outside Diameter	Stock No.	Screw or Bolt Dia.	Outside Diameter
242-308	5/32	3/8"	243-306	M6	17.0mm
242-310	3/16	7/16"	243-307	M6.3	14.3mm
242-314	1/4	1/2"	243-308	M8	25.0mm
242-316	5/16	5/8"	243-310	M10	24.0mm
242-318	3/8	25/32"	243-312	M12	21.4mm
242-320	7/16	27/32"	243-314	M14	25.0mm
242-322	1/2	15/16"			

GARAGE ASSORTMENT No. 020-076

Contains 100 Inch retainers in 1/4, 5/16, 3/8, 7/16 and 1/2. Packed in a sturdy, transparent plastic box.



GARAGE ASSORTMENT No. 020-077

Contains 100 Metric Retainers in M6, M8, M10 and M12. Packed in a clear, plastic, compartmentized box

papeco 'PUSHNUT' FASTENERS ATTACHES 'PUSHNUT'

BRIGHT ZINC PLATED



These flat, round type, spring steel fasteners are pushed on unthreaded rods, studs, etc. Used on nameplates, moulding studs and shafts.

Order by Stock Number

Standard Package 100 Pieces

Stock No.	Stud Size	Outside Diameter	Stock No.	Stud Size	Outside Diameter
242-401	1/16	.195"	242-413	.240	17/32"
242-403	3/32	.195"	242-414	1/4	17/32"
242-406	1/8	3/8"	242-416	5/16	5/8"
242-408	5/32	7/16"	242-418	3/8	3/4"
242-410	3/16	7/16"	242-422	1/2	1"

papeco METRIC 'PUSHNUT' FASTENERS ATTACHES 'PUSHNUT' METRIQUE

BLUE ZINC PLATED

Order by Stock Number

Standard Package 100 Pieces

Stock No.	Stud Size	Outside Diameter	Stock No.	Stud Size	Outside Diameter
243-403	3.2mm	9.5mm	243-405	5.0mm	11.0mm
243-404	4.0mm	11.0mm			



GARAGE ASSORTMENT No. 020-084

Contains 100 Pushnut Fasteners in both Inch and Metric - 10 sizes in all. Packed in a transparent plastic box with hinged lid.

papeco MASTER ASSORTMENT No. 020-674

Contains 325 pieces - 20 popular sizes of Regular and Self-Threading Palnuts plus Bolt Retainers and Pushnuts. Packed in a metal box with moulded plastic compartments.

Size: 9-3/4"w. x 13-3/4"l. x 2"d.



papeco SUPER SERVICE ASSORTMENT No. 020-811

Contains 500 Regular and Self Threading Palnuts plus Bolt Retainers and Pushnuts - 32 items. Large size, rigid metal box with high-strength plastic compartments. For more details see page 9.

Large size 18" l. x 3" d.

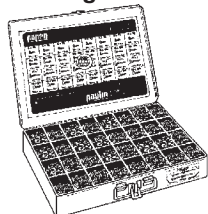



240 INCH **241 METRIC** **papeco** **MULTI-THREAD 'U' NUTS**
ECROUS 'U' FILET MULTIPLE

PHOSPHATE COATED

Spring steel nut fastens two panels, is retained in one panel. Used for sheet metal and front end assembly on GM, Ford or Chrysler fenders, shrouds and radiators, etc.

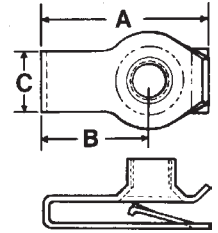

Order by Stock Number

Standard Package 25 Pieces (*10 Pcs.)

INCH							METRIC						
Stock No.	Bolt or Screw Size	Length 'A'	Throat Depth 'B'	Width 'C'	Panel Thickness	Factory No.	Stock No.	Bolt or Screw Size	Length 'A'	Throat Depth 'B'	Width 'C'	Panel Thickness	Factory No.
240-614	1/4-20	0.920	0.540	0.520	0.150	1494252	241-604	M4x.7	21.5	10.5	11.0	3.8	11500654
240-615	1/4-20	1.250	0.8125	0.520	0.150	45267	241-605	M4x.7	22.0	14.5	10.0	3.8	11500655
240-616	5/16-18	0.980	0.580	0.580	0.150	45264	241-606	M6x1.0	24.0	13.7	13.0	4.0	11503714
240-617	5/16-18	1.250	0.875	0.580	0.150	379831-S	241-607	M6x1.0	30.0	20.0	13.0	4.0	11503715
240-618	3/8-16	1.670	1.100	0.720	0.200	45269-S2	241-608	M8x1.25	32.0	21.5	14.7	4.0	11500661
240-619	3/8-16	1.3125	0.750	0.9375	0.200	1494254	241-609	M8x1.25	25.5	15.0	14.7	4.0	11500660
							241-610*	M10x1.5	33.0	19.0	18.0	6.0	11500662
							241-612	M6.3x1.0	24.0	20.0	13.5	4.0	11500658

For Body Bolts see page 92.

MULTI-THREAD 'U' NUT GARAGE ASSORTMENT No. 020-078

Contains 65 Inch Multi-Thread 'U' Nuts. 4 sizes each in its own compartment. Packed in a sturdy, transparent plastic box with hinged lid.



MULTI-THREAD 'U' NUT GARAGE ASSORTMENT No. 020-079

Contains 50 Metric Multi-Thread 'U' Nuts. 7 sizes packed in a clear plastic box with hinged lid.

240 INCH

papeco **SINGLE THREAD 'U' NUTS**
ECROUS 'U' FILET-UNE

PHOSPHATE COATED

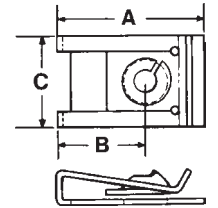

Order by Stock Number

Standard Package 25 Pieces

Stock No.	Screw Size	Length 'A'	Throat Depth 'B'	Width 'C'	Panel Thickness	Factory No.	Stock No.	Screw Size	Length 'A'	Throat Depth 'B'	Width 'C'	Panel Thickness	Factory No.
240-706	No. 6	0.890	0.375	0.575	0.125	9424837	240-714	No. 14	0.785	0.344	0.650	0.156	45258
240-708	No. 8	0.785	0.375	0.550	0.125	9431530	240-715	No. 14	1.000	0.563	0.650	0.156	45261
240-709	No. 8	1.000	0.625	0.550	0.125	11504531	240-726	M6.3	0.988	0.845	0.640	0.340	—
240-710	No. 10	0.785	0.344	0.650	0.125	152492							

SINGLE THREAD 'U' NUT GARAGE ASSORTMENT No. 020-080

Contains 65 Single Thread 'U' Nuts. 5 sizes packed in a transparent plastic box with hinged lid.



'U' NUT MASTER ASSORTMENT No. 020-692

Contains 100 'U' Nuts in both Multi-Thread and Single Thread types. Packed in a metal box with high-strength plastic compartments.

Total of 20 sizes Inch, Metric for Complete Coverage.

245
Series



BODY BOLTS
BOULONS DE CARROSSERIE



Special Indented Hexagon Head Bolts with aligning points for pre-drilled panels. Phosphate finish.

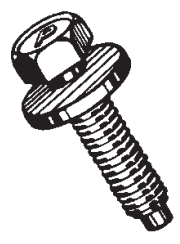

Type 1
Conical
Washer Head
Dog-Point

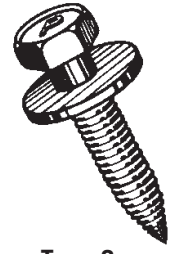

Type 2
Conical
Washer Head



Type 3
Hex Washer
Head



Type 4
Hex Head
Sems

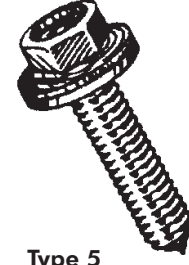

Type 5
Nylon Washer
Hex Washer
Head

Order by Stock Number

Standard Package 25 pieces *15 pcs.

Stock No.	Size	Type	Washer O.D.	Factory No.	Stock No.	Size	Type	Washer O.D.	Factory No.
245-322	M6x1.0x22	1	19mm	N-606676	245-505	M6x1.0x20	3	13mm	11503800
245-325	M6x1.0x30	1	19mm	6100568	245-507	M6x1.0x25	3	13mm	11503958
245-400	M4.2x1.41x20	4	16mm	11500434	245-510	M6x1.0x35	2	17mm	11505044
245-405	M6x1.0x20	2	17mm	11502941	245-525	M8x1.25x25	3	17mm	11503632
245-407	M6x1.0x25	2	17mm	11503834	245-527	M8x1.25x30	3	17mm	11500971
245-408	M6x1.0x25	2	24mm	11503982	245-610	1/4-20x11/4S/S	5	5/8	14007511
245-420	M6.3x1.0x20	2	17mm	11501105	245-615	5/16-18x7/8	2	11/16	3846202
245-424	M6.3x1.0x25	2	18mm	11500754	245-616	5/16-18x1	2	7/8	3968521
245-425	M6.3x1.0x25	2	24mm	365718	245-620	3/8-16x1	2	1"	3986997
245-440	M8x1.25x30	2	24mm	11501188	245-630	3/8-16x11/2	2	11/8	407217
245-450*	M10x1.5x40	2	30mm	11501193					

For Body Bolt `U` Nuts see page 91.

BODY BOLTS ASSORTMENT
MASTER ASSORTMENT No. 020-691

Contains 150 Body Bolts - 20 sizes. Packed in a metal box with high-strength plastic compartments. Every item is fully illustrated on a grease resistant lid label.

Size: 9-3/4" w. x 13-3/4" l. x 2" d.



For SUPER-SERVICE Assortment No. 020-823 of `U` Nuts and Body Bolts see page 88.



POWER STEERING CAPS
BOUCHONS POUR POMPE DE SERVO-DIRECTION

Replacement units for lost or broken original equipment Power Steering Pump Caps. Individually Packaged.



Order by Stock Number

Stock No.	Description	Stock No.	Description
249-150	GM	249-152	FORD



244
Series

papco

**METRIC FLANGE HEX BOLTS
BOULONS DE REBORD METRIQUE**

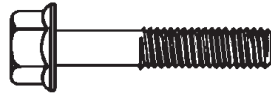
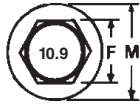

IFI SPEC (SMALL HEAD) • ZINC PLATED STEEL

Used for automotive body applications and general use where large bearing contact is required over clearance holes or softer material. Conform to Metric Property Class 10.9 (slightly 9% stronger than S.A.E. Grade 8).

Order by Stock Number

Stock No.	Dia. x Pitch x Length	Hex `F` mm	Flange `M` mm	Std. Pkg.	Stock No.	Dia. x Pitch x Length	Hex `F` mm	Flange `M` mm	Std. Pkg.
244-267	M6x1.0x12mm	8	13	20	244-323	M8x1.25x45mm	10	16.5	20
244-270	M6x1.0x16mm	8	13	20	244-324	M8x1.25x50mm	10	16.5	15
244-272	M6x1.0x20mm	8	13	20	244-326	M8x1.25x60mm	10	16.5	15
244-274	M6x1.0x25mm	8	13	20	244-328	M8x1.25x70mm	10	16.5	15
244-276	M6x1.0x30mm	8	13	20	244-364	M10x1.25x16mm	13	20	15
244-277	M6x1.0x35mm	8	13	20	244-366	M10x1.25x20mm	13	20	15
244-278	M6x1.0x40mm	8	13	20	244-368	M10x1.25x25mm	13	20	15
244-279	M6x1.0x45mm	8	13	20	244-370	M10x1.25x30mm	13	20	15
244-311	M8x1.25x12mm	10	16.5	20	244-371	M10x1.25x35mm	13	20	15
244-314	M8x1.25x16mm	10	16.5	20	244-372	M10x1.25x40mm	13	20	15
244-316	M8x1.25x20mm	10	16.5	20	244-373	M10x1.25x45mm	13	20	15
244-318	M8x1.25x25mm	10	16.5	20	244-374	M10x1.25x50mm	13	20	15
244-320	M8x1.25x30mm	10	16.5	20	244-376	M10x1.25x60mm	13	20	15
244-321	M8x1.25x35mm	10	16.5	20	244-378	M10x1.25x70mm	13	20	10
244-322	M8x1.25x40mm	10	16.5	20					

611
Series

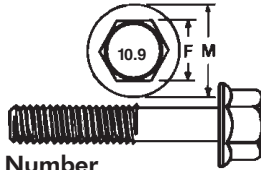

JIS SPEC B1189 • ZINC PLATED STEEL

Used primarily in Asian import applications and general use where large bearing contact is required over clearance holes or softer material. Conform to Metric Property Class 10.9 (slightly 9% stronger than S.A.E. Grade 8).

Order by Stock Number

Stock No.	Dia. x Pitch x Length	Hex `F` mm	Flange `M` mm	Std. Pkg.	Stock No.	Dia. x Pitch x Length	Hex `F` mm	Flange `M` mm	Std. Pkg.
611-267	M6x1.0x12mm	10	14	20	611-320	M8x1.25x30mm	12	17.5	20
611-270	M6x1.0x16mm	10	14	20	611-321	M8x1.25x35mm	12	17.5	20
611-272	M6x1.0x20mm	10	14	20	611-322	M8x1.25x40mm	12	17.5	20
611-274	M6x1.0x25mm	10	14	20	611-324	M8x1.25x50mm	12	17.5	15
611-276	M6x1.0x30mm	10	14	20	611-364	M10x1.25x16mm	14	21	15
611-277	M6x1.0x35mm	10	14	20	611-366	M10x1.25x20mm	14	21	15
611-278	M6x1.0x40mm	10	14	20	611-368	M10x1.25x25mm	14	21	15
611-311	M8x1.25x12mm	12	17.5	20	611-370	M10x1.25x30mm	14	21	15
611-314	M8x1.25x16mm	12	17.5	20	611-371	M10x1.25x35mm	14	21	15
611-316	M8x1.25x20mm	12	17.5	20	611-372	M10x1.25x40mm	14	21	15
611-318	M8x1.25x25mm	12	17.5	20					

papco

**METRIC FLANGE NUTS
ECROUS DE REBORD METRIQUE**

PHOSPHATE COATED



Type 1



Type 3
Free Spin

Use with 'Papco' Metric Body Bolts or where oversize clearance holes or low compressive strength materials are being bolted. Metric Property Class 9.

Order by Stock Number

Standard Package 25 Pieces

Stock No.	Dia. x Pitch	Hex `F` mm	Thick `H` mm	Flange `M` mm	Type	Factory No.	Stock No.	Dia. x Pitch	Hex `F` mm	Thick `H` mm	Flange `M` mm	Type	Factory No.
244-956	M6x1.0	10	5	16	3	11503752	244-987	M8x1.25	13	8	17.6	1	11501889
244-957	M6x1.0	11	9.5	19	3	11503754	244-988	M10x1.50	15	11.2	21.5	1	11501850
244-958	M6.3x1.0	11	9	16	3	11501106	244-990	M12x1.75	18	13.5	25.6	1	11502723
244-986	M6x1.0	10	6.7	14.2	1	11503745							

ZINC PLATED STEEL

Order by Stock Number

Standard Package 25 Pieces

Stock No.	Dia. x Pitch	Hex `F` mm	Thick `H` mm	Flange `M` mm	Type	Factory No.
244-996	M6x1.0	10	6.7	13	2	—
244-997	M8x1.25	12	8	17	2	—
244-998	M10x1.25	14	11.2	20	2	—

Type 2
Serrated Face



Use with 'Papco' JIS Metric Flange Bolts or where oversize clearance holes or low compressive strength materials are being bolted. Metric Property Class 9.

245
Series

papco® **BUMPER BAR BOLTS**
BOULONS DE PARE-CHOC

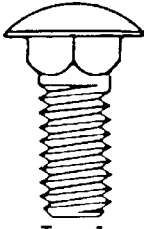

Type 1

Round Head

STAINLESS STEEL CAPPED

'Papco' Bumper Bar Bolts are capped with 18.8 STAINLESS STEEL, carefully polished and buffed to a high lustre. All bolts are Bright Plated to resist rust.



Type 2
Semi-Round
Head

Standard Package contains 12 Bumper Bar Bolts and 12 Self-Locking Nuts.
* 6 Bumper Bar Bolts and 6 Self-Locking Nuts.

Order by Stock Number

Stock No.	Bolt Size	Type	Stock No.	Bolt Size	Type	Stock No.	Bolt Size	Type
245-154	5/16-18 x 1-1/4	1	245-171	7/16-14 x 1	1	245-182	1/2-13 x 1-1/4	1
245-160	3/8-16 x 3/4	1	245-172	7/16-14 x 1-1/4	1	245-183*	1/2-13 x 1-1/2	1
245-161	3/8-16 x 3/4	2	245-173	7/16-14 x 1-1/2	1	245-184	1/2-13 x 1-3/4	1
245-164	3/8-16 x 1	1	245-174	7/16-14 x 1-3/4	1	245-185	1/2-13 x 2	1
245-165	3/8-16 x 1	2	245-175	7/16-14 x 2	1	245-190	9/16-12 x 1-1/2	1
245-167	3/8-16 x 1-1/4	1	245-178	7/16-14 x 2-3/4	1			
245-170	7/16-14 x 7/8	1	245-179	7/16-14 x 3-1/2	1			

061
Series

papco® **GRADE B STOVER® LOCKNUTS**
ECROUS A BLOCAGE 'STOVER®'

CADMIUM PLATED
and WAXED

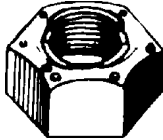

These nuts lock in position when tightened with a wrench.

Stock No.	Bolt Size	Std. Pkg.	Stock No.	Bolt Size	Std. Pkg.
061-016	5/16-18	100	061-020	7/16-14	50
061-018	3/8-16	100	061-022	1/2-13	50

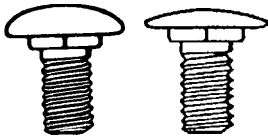

Type 1

Type 2

papco® **METRIC BUMPER BAR BOLTS**
BOULONS DE PARE-CHOC METRIQUE

BUTTON HEAD
BLUE ZINC PLATED

Order by Stock Number

Standard Package 10 Bolts and 10 Metric 'Pozi-Lok' Nuts.

Stock No.	Bolt Size	Description	Type	Stock No.	Bolt Size	Description	Type
245-220	M8 x 1.25 x 20mm	Chrome Plated Cap	1	245-223	M8 x 1.25 x 27mm	Uncapped	2
245-221	M8 x 1.25 x 30mm	Uncapped	1	245-233	M10 x 1.5 x 33.5mm	Stain. Steel Cap	2
245-222	M8 x 1.25 x 28mm	Stainless Steel Cap	2	245-238	M12 x 1.75 x 35mm	Stain. Steel Cap	2

BUMPER BAR BOLT
MASTER ASSORTMENT No. 020-611

This assortment contains 68 Bumper Bar Bolts and 68 Self-Locking Nuts in 15 sizes selected according to popularity. Packed in a metal box with moulded plastic compartments. Descriptive lid label shows retail price codes. Will service all popular replacement needs including Metric.

Size: 9-3/4" w. x 13-3/4" l. x 2" d.



For Metric 'POZI-LOK' Nuts see page 25.



245
Series

papco

LICENCE PLATE BOLTS BOULONS DE PLAQUE

NOW - Service Stations, Garages, Dealers can turn licence plate installations into a profitable sale. 'Papco' Licence Plate Bolts are made of either heavily electro-plated steel or UV stabilized Nylon.

Order by Stock Number

Standard Package as Indicated

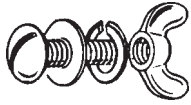

STOCK No. 245-901

Consists of Bolt, Washer, Lock Washer and Wing Nut. Bolt is 1/4-20 x 5/8. Standard Package contains 100 assemblies.



STOCK No. 245-902

Consists of Bolt, Washer, Lock Washer and Square Nut. Bolt is 1/4-20 x 5/8. Standard Package contains 100 assemblies.

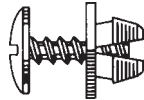

STOCK No. 245-906 UNIVERSAL NYLON LICENCE PLATE NUT with SCREW

Fits all Ford, G.M. and Chrysler products having a 3/8" Square Hole. Assembly consists of a 14 x 5/8" Screw and #14 Square Nylon Nut. Standard Package contains 50 assemblies.

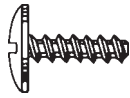

STOCK No. 245-910

No. 14 x 5/8" Special Truss Slot Head, Type 'B' Licence Plate Screw. Electro-plated to resist rust. Standard Package 100 Screws.



STOCK No. 247-840

No. 14 Square Nylon Licence Plate Nut for most domestic and import vehicles. Standard Package contains 25 Nuts.



STOCK No. 213-278

No. 14x3/4 Indented Hexagon Slotted Washer Head Screws. Electro-plated to resist rust. Can be used with 247-840 Nylon Nuts. Standard Package 100 Screws.

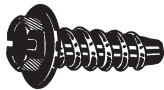

STOCK No. 245-903

For most compact Fords. No. 14x5/8 Indented Hex Slotted Over-size Washer Head Screws. Black Zinc to resist rust. Standard Package 100 Screws. Can be used with 247-840 Nylon Nut.

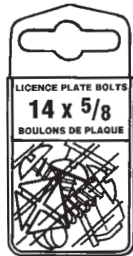

LICENCE PLATE BOLTS ASSORTMENT No. 020-867

- Each set packed in an attractive hang-up plastic box.
- Set contains 8 pieces -
4 Steel Screws No. 245-910 and
4 Nylon Licence Plate Nuts No. 245-911.
- Screw is heavily plated to resist rust.

Standard Package contains 48 Individual Sets of No. 006-109.

No. 006-109

papco NYLON LICENCE PLATE BOLTS

'Papco' Nylon Licence Plate Bolts are made of stabilized Nylon. Self-locking - Can't rust - Long Lasting.

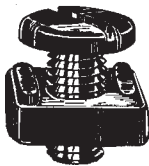

STOCK No. 245-909

Assembly consists of 1/4-20x1/2 Nylon Bolt and a 1/4-20 Self Locking rectangular Nut. Standard Package contains 100 assemblies.

1/4-20x1/2
245-909

STOCK No. 245-908

Assembly consists of M6x20 Nylon Bolt and a M6 Nylon Hex Nut. Standard package contains 100 assemblies.

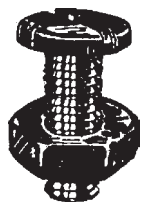

M6x20mm
245-908

246
Series

papco

**MOULDING BOLTS
BOULONS DE MOULURE**



Order by Stock Number

Illustrations Actual Size

Standard Packages 25 Pieces
*Standard Packages 50 Pieces

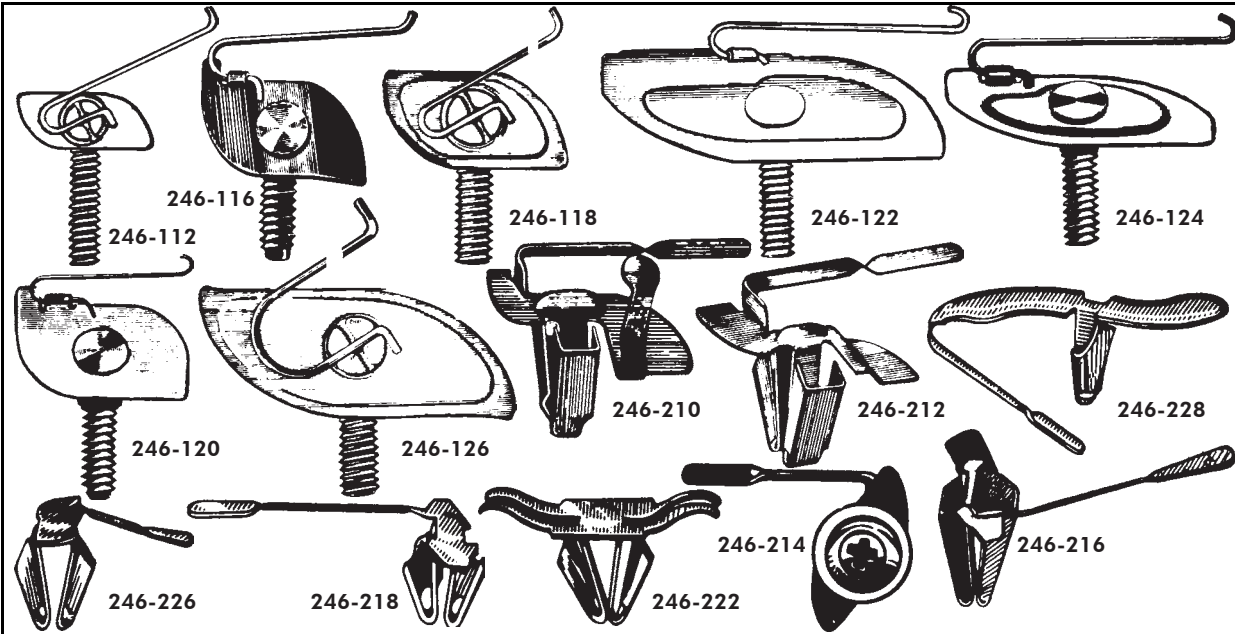

Stock No.	Factory No.	Application
246-112*	6010093, 1624705	Universal 'T' Bolt Clip 10-24x3/4"
246-116*	3792051	Chevrolet Front Fender 10-24x5/8"
246-118*	1165051	Chevrolet and Olds Front and Rear Fender 12-24x5/8"
246-120*	10-24x1/2 Universal	Universal 'T' Bolt Clip
246-122*	1758099, 6000720, 6010046, 3744999	Universal 'T' Bolt Clip 10-24x1/2
246-124*	3722635, 6013029, 6000705	Universal 'T' Bolt Clip 10-24x3/4
246-126*	4730773, 4637277	Universal 'T' Bolt Clip 12-24x3/4
246-210	4759145, 4761842, 4779348	GM Front and Rear Fender and Door Peak - All
246-212	3944866	GM General Purpose
246-214	9645350	GM Door and Door Belt
246-216	1484570	GM General Purpose
246-218	1484569, 6002356	General Purpose Belt Moulding
246-222	D5AB-60423B06-AA, D5DB-66423B06-CA	Ford Moulding
246-226	D5DB-66423-B06	Ford Belt Moulding
246-228	D8KB-5420908AA, 4003695	Ford Moulding

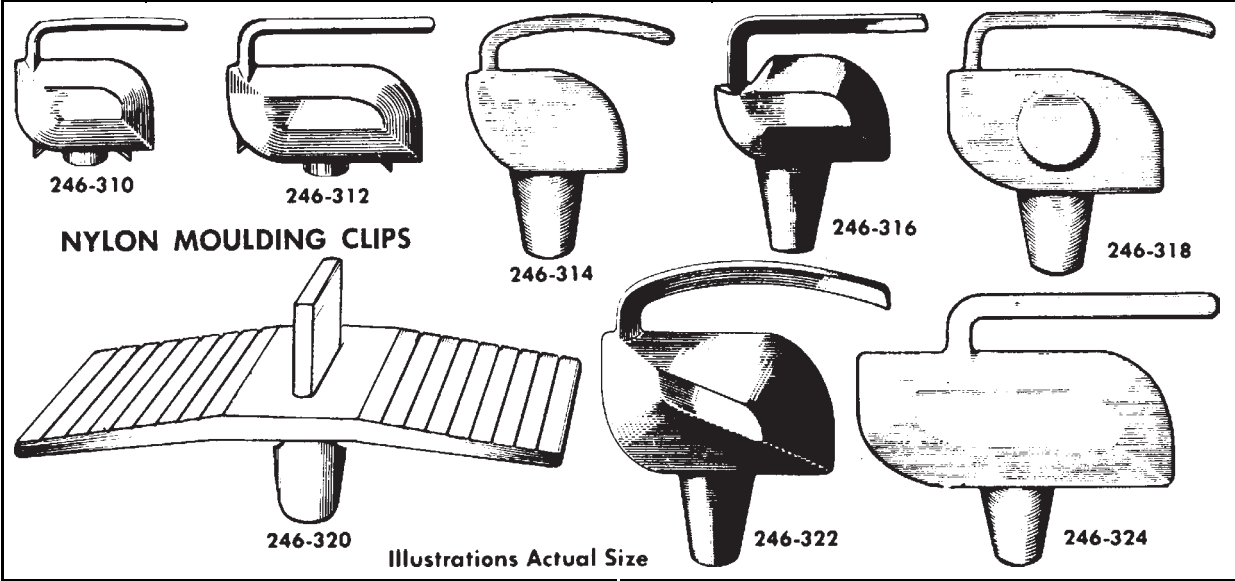

Illustrations Actual Size

Stock No.	Factory No.	Application	Stock No.	Factory No.	Application
246-310	4886720, 4417599	GM Front and Rear Fenders	246-318	4883164	Rear Fender Lower Moulding
246-312	4879481	GM Front and Rear Door	246-320	Universal	Nylon Push-in Type fits 3/8 hole
246-314	4853108	GM Front and Rear Door	246-322	4877001	Rear Fender Lower Moulding
246-316	4877000	GM Door and Fender	246-324	Universal	Rat-Tail Type

For 'Papco' Moulding Bolt Super-Service Assortment No. 020-822 see page 9.



246
Series

papeco MOULDING CLIPS
PINCES DE MOULURE

Order by Stock Number

Illustrations Actual Size

Standard Package 25 pieces (* 100 pieces)

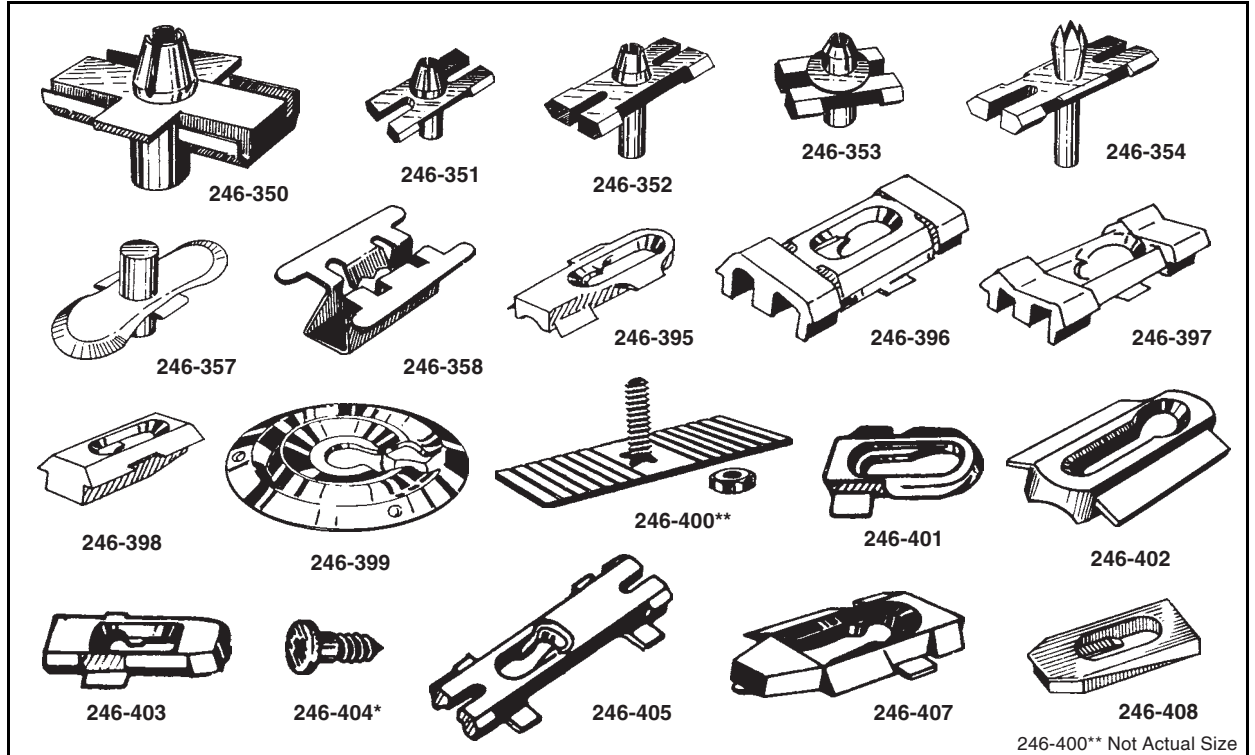

Stock No.	Factory No.	Application
246-350	1201-930	Volvo Side Moulding Clip Black
246-351	803-853-139C	VW Moulding Clip Red
246-352	825-853-139	Audi Moulding Clip
246-353	5113-1-804-205	BMW Moulding Clip With Sealer
246-354	1202-997	Volvo Moulding Clip Green
246-357	1-247-708	Volvo Side Moulding
246-358	90183-03001	Toyota Front Bumper, Cushion Clip
246-395	8799350	GM Rear End and Quarter Panel Moulding
246-396	20175051	GM Quarter Belt Reveal Moulding
246-397	20199675	GM Quarter Belt Reveal Moulding
246-398	1688094	GM Vinyl Top Moulding
246-399	3986976	GM Rocker Panel Moulding - Metal
246-400	10-24x3/4 Universal	Scored Type Moulding Bolt fits up to 2 1/2" wide
246-401	9838109	GM Body Side Moulding
246-402	4492962	GM Body Side and Wheel Opening Moulding
246-403	D1MY 65402488	Ford Roof Cover and Body Side Mouldings
246-404*	4-24x3/8 Special Phillips Flat Head	Screw (replaces Welded Studs)
246-405	6003133	Chrysler Door and Fender
246-407	DSAZ-7120818-A	Ford Door, Quarter Panel and Roof Moulding
246-408	9727078	GM Belt Moulding

246-400** Not Actual Size

246
Series

papeco WINDOW REGULATOR RIVETS
RIVET REGULATEUR DE FENETRE

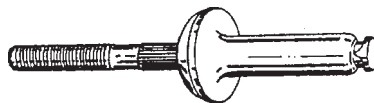

Aluminum Body/ Steel Mandrel

Order by Stock Number

Standard Packages 25 pieces

Stock No.	Factory No.	Dia.	Flange	Max Grip	Application
246-600	9436175, 385189-S100, 6031115	1/4	1/2	9/64"	GM, Ford, Chry, Window Regulator
246-605	20184399, 389268-S100	1/4	1/2	3/4"	GM, Ford, Window Regulator
246-610	385323-S100, 6031091	1/4	1/2	19/32"	Ford, Chrysler, GM Window Regulator
246-612	388047-S100	1/4	1/2	1/8"	Ford Door Handle Assembly, GM Heat Shield Attach.

For Moulding Clip Master Assortment No. 020-684 see page 8.



Order by Stock Number

Illustrations Actual Size

Standard Packages 25 pieces (* 10 pieces)

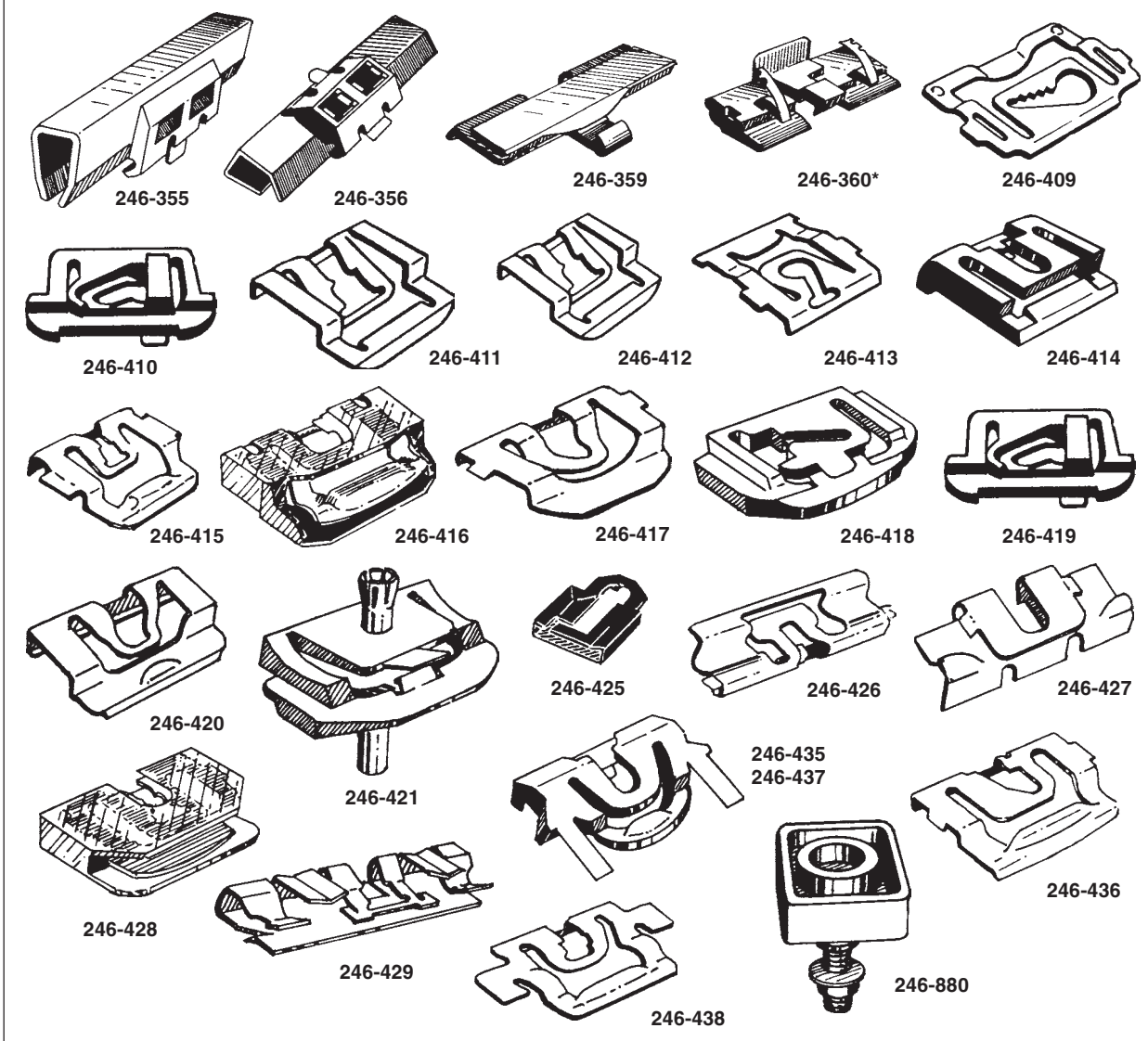

Stock No.	Factory No.	Application
246-355	1-246-926	Volvo Windshield Moulding Grey
246-356	1-255-553	Volvo Windshield Moulding White
246-359	75546-32010, 75548-32010	Toyota Windshield Moulding with Adhesive Pad
246-360*	90674-692-0030	Honda Windshield Moulding with Adhesive Pad
246-409	9895598	GM Windshield Reveal Moulding
246-410	1654047 (Nylon)	GM Windshield and Rear Window Reveal Moulding
246-411	8717859, 9854717	GM Rear Window Reveal Moulding
246-412	C8AZ-63642413-A, D1AZ-6542413-B	Ford Rear Window and Windshield Moulding
246-413	6003049	Chrysler Windshield and Rear Window Reveal Moulding
246-414	D9AZ-5403178-A (Nylon)	Ford Windshield Top Reveal Moulding
246-415	E3SB-6342413-AB	Ford Windshield and Backlite Moulding
246-416	6003878 (Nylon/Metal)	Chrysler Windshield Backlite Moulding
246-417	9662950	GM Windshield and Rear Window Reveal Moulding
246-418	9731301 (Nylon)	GM Windshield to Panel Lower Side
246-419	20169887 (Nylon)	GM Windshield Reveal Moulding
246-420	9808241	GM Windshield and Rear Window Reveal Moulding
246-421	20113224 (Nylon)	GM Reveal Windshield Lower Moulding
246-425	4234830	GM Door Lock Rod Clip
246-426	E4ZB-6142413-AA	Ford Backglass Moulding
246-427	D8VZ-6003166-A (Nylon/Metal)	Ford Windshield and Rear Glass Reveal Moulding
246-428	E2ZB-6142413-AA	Ford Windshield Backlite Moulding
246-429	E7SZ-6342413-A	Ford Backglass Moulding
246-435	6003755 (Nylon)	Chrysler Windshield and Backlite Reveal Moulding
246-436	6003752	Chrysler Windshield and Backlite Reveal Moulding
246-437	6003755 (Nylon)	Chrysler Windshield and Backlite Reveal Moulding
246-438	6003426	Chrysler Window Reveal Moulding
246-880	D6AZ-5323240-A	Ford Roller and Nut Window Guide

For Windshield Clip Master Assortment No. 020-681 see page 8.



246
Series

papco GLASS SHOP FASTENERS ATTACHES A PARE-BRISE

'Papco' Window Channel Guides are used to repair loose or dislodged door windows when original guides break. Fold-over, snap-on guides are attached to edge of window glass to maintain alignment in door channels.

Order by Stock Number

Illustrations Not Actual Size

Standard Packages 25 pieces

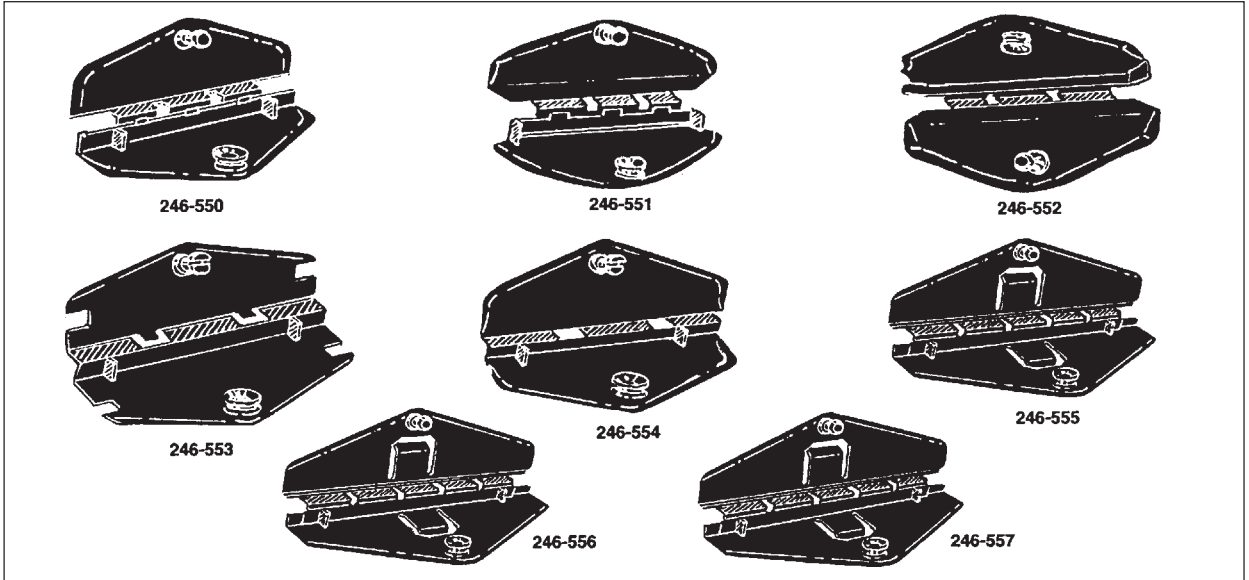

Stock No.	Factory Number	Application
246-550	20162174, 22543363	GM Front Door Window Guide "J" Bodies
246-551	20747509	GM Front Door Window Guide "C" and "H" Bodies
246-552	20478733, 22539533	GM Front Door Window Guide Rear Olds, Buick "C" Bodies
246-553	10051034, 20123070, 20328600	GM Front Door Window Guide "B" "C" and "X" Bodies
246-554	20160591	GM Rear Door Window Guide Wagons, "B", "C" and "X" Bodies
246-555	20747508, 20487631	GM Front Door Window Guide "C" Bodies
246-556	12353912, 20487630, 20712176	GM Front Door Window Guide Olds, Buick "C" Bodies
246-557	10051034, 10114597, 12338011	GM Front Door Window Guide "A" Bodies, "S" Trucks



WINDSHIELD MOULDING RELEASE TOOL **OUTIL POUR ENLEVER MOULURES DE PARE-BRISE** **No. 246-500**

For removing all windshield mouldings. Features angled shaft and bevelled front edges for easy entry. Individually carded.

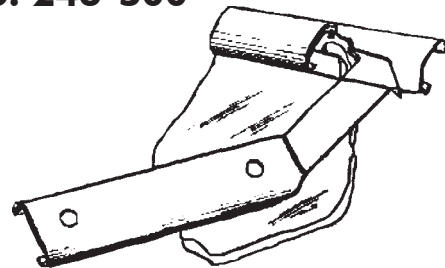

WINDOW HANDLE REMOVING TOOL **OUTIL DEMONTE-MANIVELLE** **No. 246-895**

For removing clips inside door and window handles. Raised end can be used to remove door panels. Individually carded.

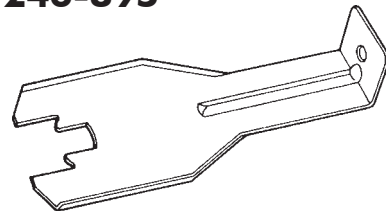



The flexible ribs of these nylon fasteners deflect as the clip is pushed into a panel hole and hold securely anywhere along their ribbed shank. The Cut-Out-Type can be twisted into a small panel hole for retention. Used on inner door panels to hold covering or trim.

Order by Stock Number Illustrations Actual Size Standard Package 25 pieces

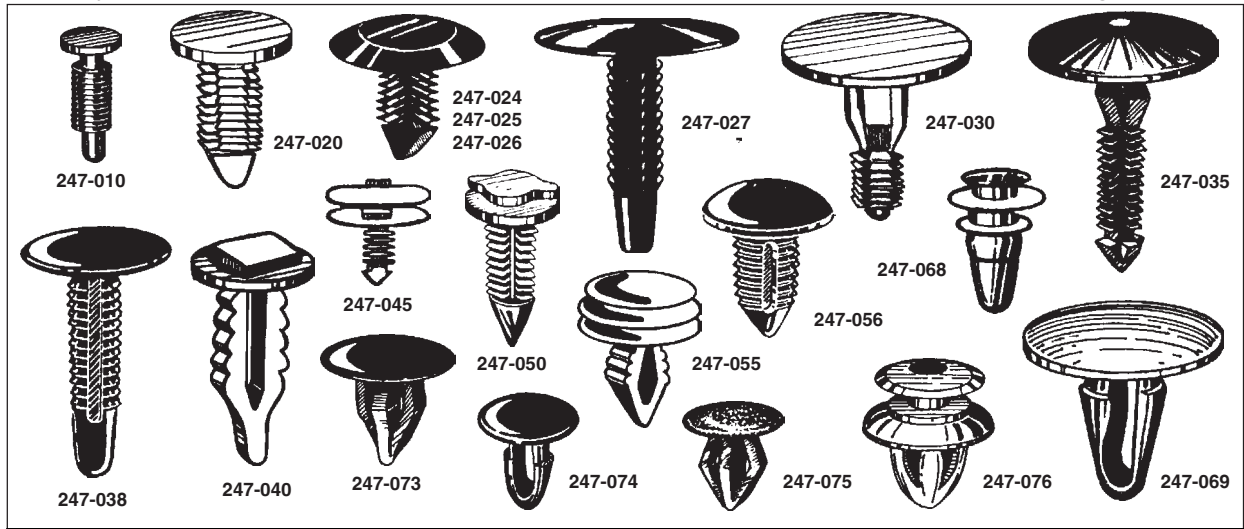

Stock No.	Factory No.	Application	Stock No.	Factory No.	Application
247-010	411700	GM - Trim Panel Retainer	247-045	6003654	Chrysler - Door & Bumper Trim
247-020	25514222, 6003587	GM, Chrysler - Roof Headliner	247-050	20298365, 6013122	GM, Chrysler - Trim Panel Ret.
247-024	389443-S	Ford - Fascia To Bumper	247-055	387477-S	Ford - Interior Trim Panel
247-025	385661-S, 6003349	Ford, Chrysler - Trim Panel	247-056	22512276	GM - Panel Retainer
247-026	2048248, 6003423	GM, Chrysler - Int. Trim Panel	247-068	95005064, 67771-01010	GM, Toyota - Door Trim Panel
247-027	388930-S	Ford - Trim Panel Retainer	247-069	90467-09008	Toyota - Retaining Clip
247-030	D6NW9452-118-A	Ford - Roof Trim	247-073	38529-689A-6300	Honda - Retaining Clip
247-035	N-800387-S	Ford - Dashboard	247-074	90467-06161-01	Toyota - Retaining Clip
247-038	389443-S	Ford - Trim Panel Retainer	247-075	76906-T3000	Nissan - Retaining Clip
247-040	20036949	GM - Trim Panel Retainer	247-076	680-097	Volvo - Moulding Retainer

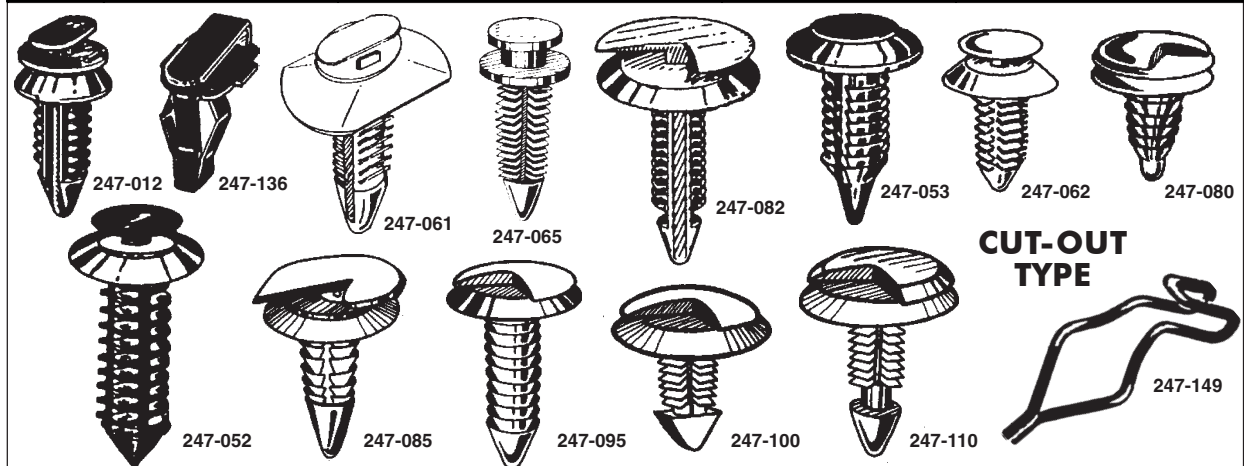

Stock No.	Factory No.	Application	Stock No.	Factory No.	Application
247-012	15545202	GM - Door Trim Panel	247-082	10126901	GM - Trim Panel
247-052	N805612-S100	Ford, GM, Jeep Eagle,	249-085	3065575	GM - Door Trim Panel
	10143422, 8934-202-599	Door Trim Panel	247-095	363137	Chev. Truck, GMC - Trim Panel
247-053	N805155-S	Ford - Door Trim Panel	247-100	9685057, 6003349	GM, Chrysler, VW - Door Trim Pl.
247-061	20421800, 15600382	GM - Door Trim Panel	247-110	387496-S	Ford - Trim Panel Retainer
247-062	N801925-S	Ford - Door Trim Panel	247-136	4114785	Chrysler - Trim Panel
247-065	387182-S	Ford - Seat Back	247-149	383033-S101	Ford - Door Trim Panel
247-080	2064891, 9883583	GM - Door Trim Pl. & Headliner			

For Trim Fastener Master Assortments No. 020-679, 680 and 682 see page 8.



247
Series

papeo PLASTIC SHIELD RETAINERS
RETENUES DE PROTEGER PLASTIQUE

Order by Stock Number

Illustrations Actual Size

Standard Packages 25 pieces (* 5 pieces)

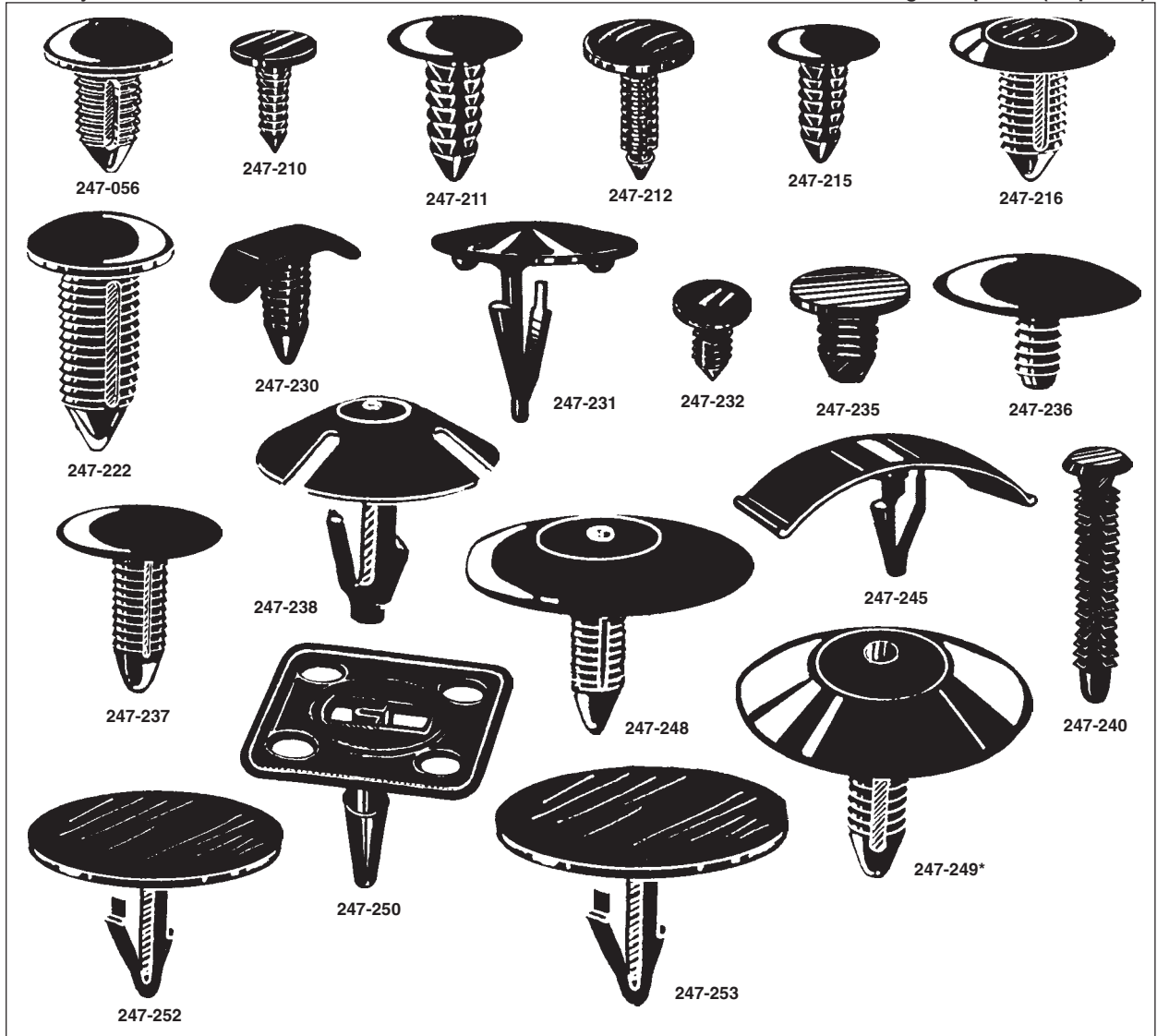

Stock No.	Factory No.	Application	Stock No.	Factory No.	Application
247-056	22512276	GM Front End Stone Shield	247-236	2998430	Chrysler, Radiator Grille
247-210	25016383	GM Dash Panel	247-237	6501067	Chrysler Fascia
247-211	1605396, 388577S	GM, Ford, Chrysler, Radiator	247-238	4341060	Chrysler Hood Insulated
247-212	20514862	GM Screen Shroud	247-240	N-800505-S	Ford Radiator Attaching
247-215	332364, 359358,	GM, Ford, Chrysler Fender	247-245	385330-S, 6003351	Ford Grille, Chrysler Hood
247-216	1619321	GM Radiator Apron	247-248	20064875	GM Hood Insulation
247-222	1631564, N804379-S	GM, Ford Bumper	247-249*	3078511, 3977775	GM Hood Insulation
247-230	480534, 384051-S	GM, Ford, Cowl Insulation	247-250	389809	GM Hood Insulation
247-231	385595-S	Ford Hood Insulation	247-252	386553-S	Ford Hood Insulation
247-232	N803170-S	Ford Fascia	247-253	388908-S	Ford Hood Insulation
247-235	20032850, 387258-S	GM, Ford, Chrysler Mud Shield			

For Trim and Weatherstrip Super-Service Assortment No. 020-813 see page 9.

TRIM PAD RELEASE TOOL No. 247-299



Made of heat-treated, high carbon steel with beveled front edges for easy insertion - plus a machined gripping slot for positive contact. Designed to remove plastic trim pad fasteners without damaging the fastener or backboard. Works well on metal trim pad fasteners. Individually carded.

247
Series

papeco WEATHERSTRIP FASTENERS
ATTACHES POUR BANDE METEOROLOGIQUE



Order by Stock Number

Illustrations Actual Size

Standard Packages 25 pieces

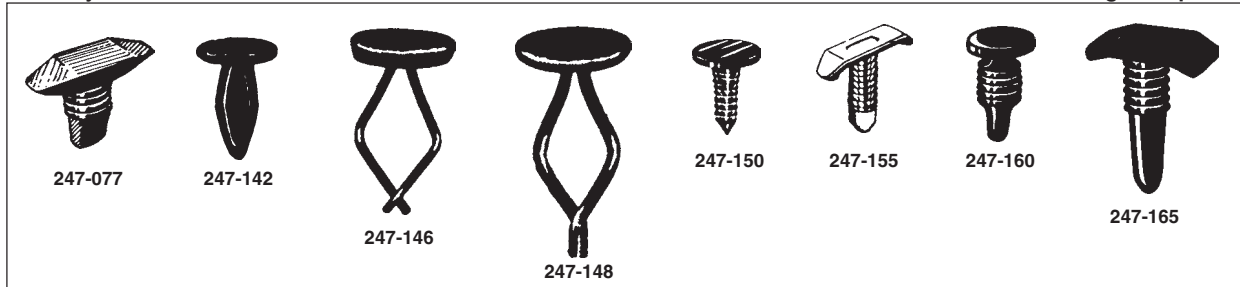

Stock No.	Factory No.	Application	Stock No.	Factory No.	Application
247-077	90664-671-0030	Honda Weatherstrip Fits 5mm Hole	247-150	8731909	GM Door Weatherstrip
247-142	4801268	GM Door Flange Weatherstrip	247-155	4876498	GM Door and Body Weatherstrip
247-146	Universal	(Brow n) Button Head Weatherstrip	247-160	2964547	Chrysler Weatherstrip
247-148	Universal	(Brow n) Button Head Weatherstrip	247-165	C5AB-6220586-A	Ford Door Weatherstrip

247
Series

papeco ANCHOR GROMMETS
MANCHONS L'ANCRE

These plastic, self-retained grommets snap into panel holes. The Spacer Type are used as secure mounting posts or bezels. The Bathtub Type accommodate alignment variations.

Order by Stock Number

Illustrations Actual Size

Standard Packages 25 pieces

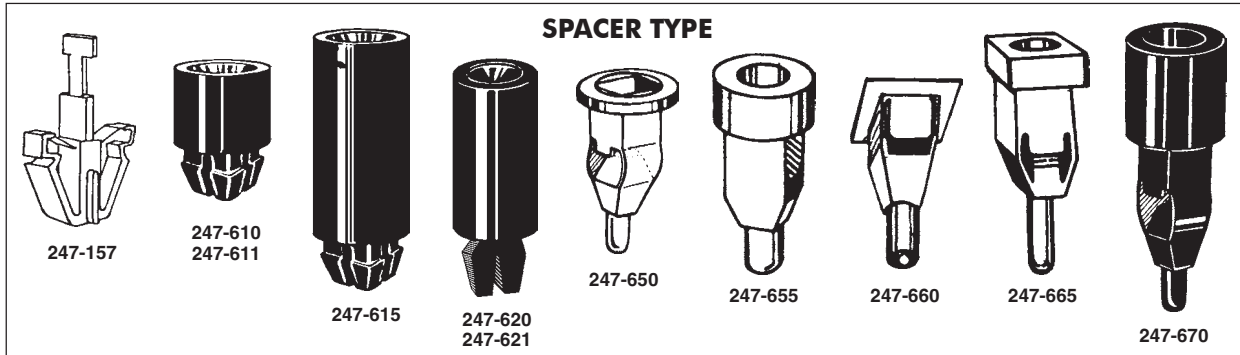

Stock No.	Factory No.	Application	Stock No.	Factory No.	Application
247-157	—	Chrysler, Ford, GM, Honda Grille Clip	247-620	3863669	GM No. 8 - 10 Thread - 1 1/4" Long
247-610	0152862	Chrysler No. 8 Thread - 3/8" Long	247-621	6027012	Chrysler Headlamp Bezel (Ext. Nut)
247-611	0152863	Chrysler No. 8 Thread - 1/2" Long	247-650	7746629	GM Headlamp Dr. Spacer Nut
247-615	0152867	Chrysler No. 8 Thread - 1" Long	247-655	411847	Oldsmobile Headlamp Door Nut
		Window Garnish Moulding Nut	247-660	—	GM Front Lamp Side Marker Att. Toggle
		Headlamp Spacer	247-665	562638	Oldsmobile No. 8 Thread
			247-670	—	Headlight Door to Fender Nut (Black)
					GM Headlamp Door Spacer

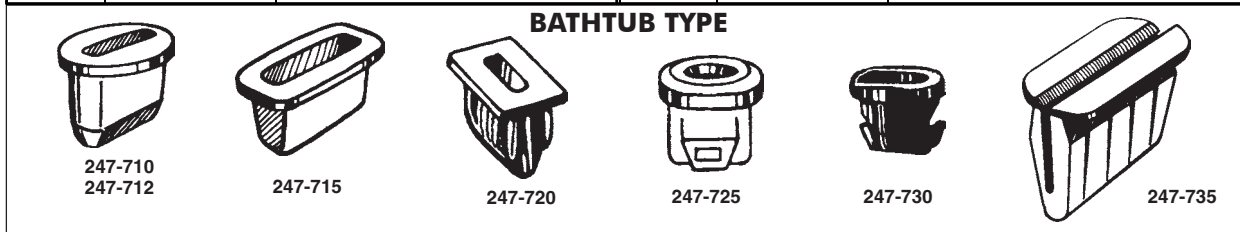

Stock No.	Factory No.	Application	Stock No.	Factory No.	Application
247-710	—	GM Headlamp Bezel Nut	247-725	6031234	Chrysler Radiator Grill #8 Screw
247-712	14032291	GM #6 or #8 Screw Grille Attachment	247-730	N-800503-S	Ford Grille Attachment Nut #6 Screw
247-715	3986978	GM General Purpose	247-735	10032838	GM, Chrysler
247-720	1255823	GM Front End Bezel Nut		1264963	(High Torque Screw Grommet)
	389360S	Ford Tail Light Nut		6031869	



247
Series

papeo ANCHOR NUTS and CLIPS
ECROUS L'ANCRE et PINCES

* 50 Pcs.
** 10 Pcs.
• 5 Pcs.
Standard Packages 25 Pcs.

Order by Stock Number

Illustrations Actual Size

Standard Packages 25 Pcs.

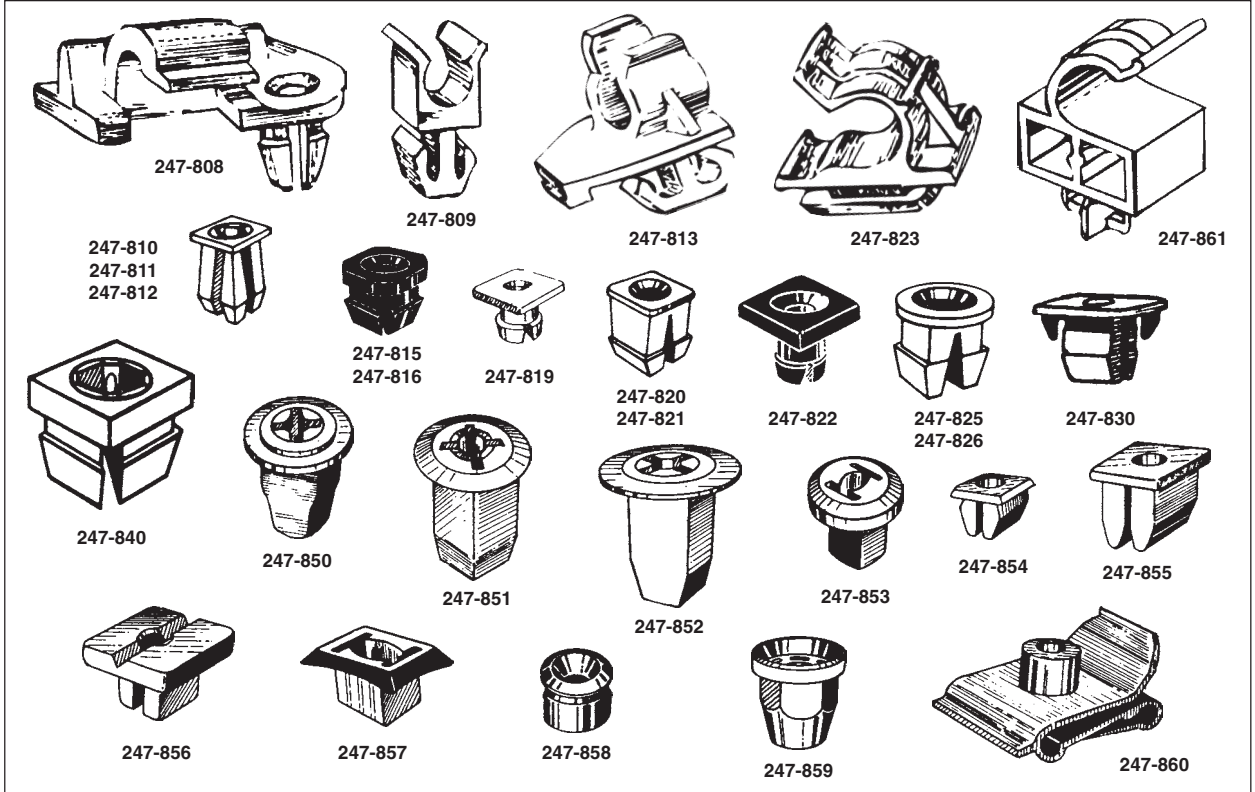

Stock No.	Factory No.	Application	Stock No.	Factory No.	Application
247-808 •	D5ZZ-16828A	Ford Hood Prop Rod Clip	247-850	90672-671-8110M1	Honda No. 6 Screw Grommet
247-809 •	386299-S	Ford Hood Prop Rod Clip	90189-04013		Toyota
247-810	379830-S	Ford Headlight Door No. 8 or 10 Screw	247-851	90661-SC7-0030	Honda No. 8 Screw Grommet
247-811	1254815	GM General Purpose No. 6 Screw	H001-50-841		Mazda
247-812	9669486	GM Side Marker No. 8 Screw	01651-00481		Nissan
247-813 •	14003756	GM Hood Prop Rod Clip	247-852	01281-00023	Nissan No. 10 Screw Grommet
247-815	3893980 (Black)	GM Grille to Front End No. 8 Screw	90189-06001		Toyota
247-816	3919773	GM Headlamp Bezel No. 8 Screw	247-853	90662-693-0030	Honda No. 6 Screw Grommet
247-819	14013246	GM No. 8 Screw	247-854	90655-SA0-0030	Honda No. 6 Screw Grommet
247-820	380382	GM Headlight Bezel No. 6 or 8 Screw	247-855	90189-05013	Toyota No. 10 Screw Grommet
247-821	6000943	Chrysler Radiator Grille No. 8 Screw	247-856	90662-671-0030	Honda No. 10 Screw Grommet
247-822	6500725 (Black)	Chrysler Headlamp Bezel No. 10 Screw		9991-00-503	Mazda
247-823 •	4103276	Chrysler Hood Prop Rod Clip	247-857	90668-688-0030	Nissan
247-825	2524525	Chrysler No. 8 or 10 Screw		000-988-15-81	Honda #6 Screw Grommet w/sealer
247-826	1355003	GM Headlight Door No.6 or 8 Screw	247-858 *	4133-5-480-120	Mercedes Benz Moulding Insert Red
247-830	6030301	GM Headlight Bezel No. 6 or 8 Screw	247-859	53879-14010-A	BMW Plastic Nut 4mm Thread
247-840	4755299	Licence Plate Nut No. 14 Screw	247-860**	90677-671-0031	Toyota "U" Nut No. 10 Screw
					Honda Holds 8mm Prop Rod

ANCHOR GROMMETS and NUTS
MASTER ASSORTMENT
No. 020-678

Contains 295 Anchor Grommets and Nuts. Packed in a metal container with high-strength plastic compartments.

ANCHOR NUTS
UTILITY ASSORTMENT
No. 020-358

Contains 150 Nuts of 247-810, to 247-840. Complete Coverage.

'PLASTI-RIVET'
UTILITY ASSORTMENT
No. 020-357

Contains 130 Rivets of 247-410, 415, 420, 450, 455, 460, 465, 470, 475, 480, 485.

Both assortments packed in a sturdy fibreboard container with actual size illustrations on label.

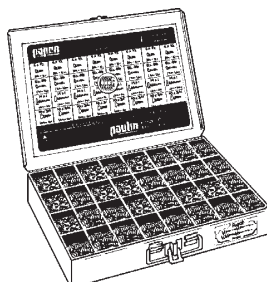

papeo SUPER SERVICE ASSORTMENT No. 020-814

Contains 465 Anchor Grommets and Nuts - 32 items.

Large size, rigid metal box with high-strength plastic compartments.

For more details see page 9.

Large size: 12" w. x 18" l. x 3" d.

247
Series

papeo **SCREW-IN RETAINERS**
ATTACHE DE SOUTIEN AVEC VIS



Order by Stock Number

Illustrations Actual Size

Standard Packages 25 pieces

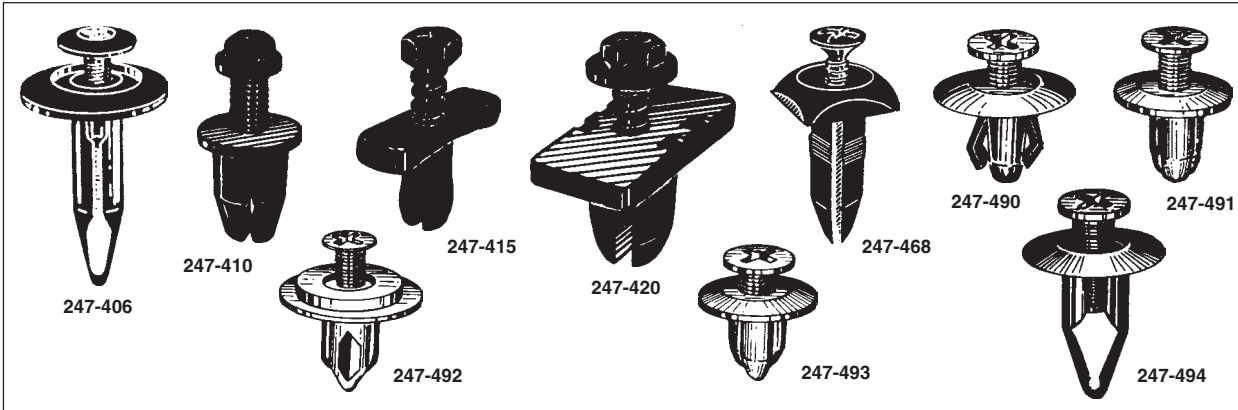

Stock No.	Factory No.	Application	Stock No.	Factory No.	Application
247-406	N804570-S	Ford Trim Retainer	247-490	90675-SB3-003	Honda Screw Retainer
	20664092	GM Exterior Body		FB01-56-964	Mazda
247-410	22500586	GM Radiator Shroud Retainer		63876-95596	Nissan
247-415	14013241	GM Grille Mounting and General Purpose	247-491	90684-SA5-0030	Honda Screw Retainer
247-420	14017689	GM Grille Rack and Signal Light		10998-30880	Nissan
247-468	N803494-S	Ford Aerostar Fascia, Trim and Grille	247-492	90668-SB0-0030	Honda Screw Retainer
	15679091	GM Blazer and Jimmy Door Handle Bezel	247-493	90467-06017-20	Toyota Screw Retainer
			247-494	63844-01A00	Nissan Screw Retainer

247
Series



'PLASTIC-RIVETS'
'RIVETS-PLASTIQUE'

Order by Stock Number

Illustrations Actual Size

Standard Package 25 Pieces (*15 pieces)

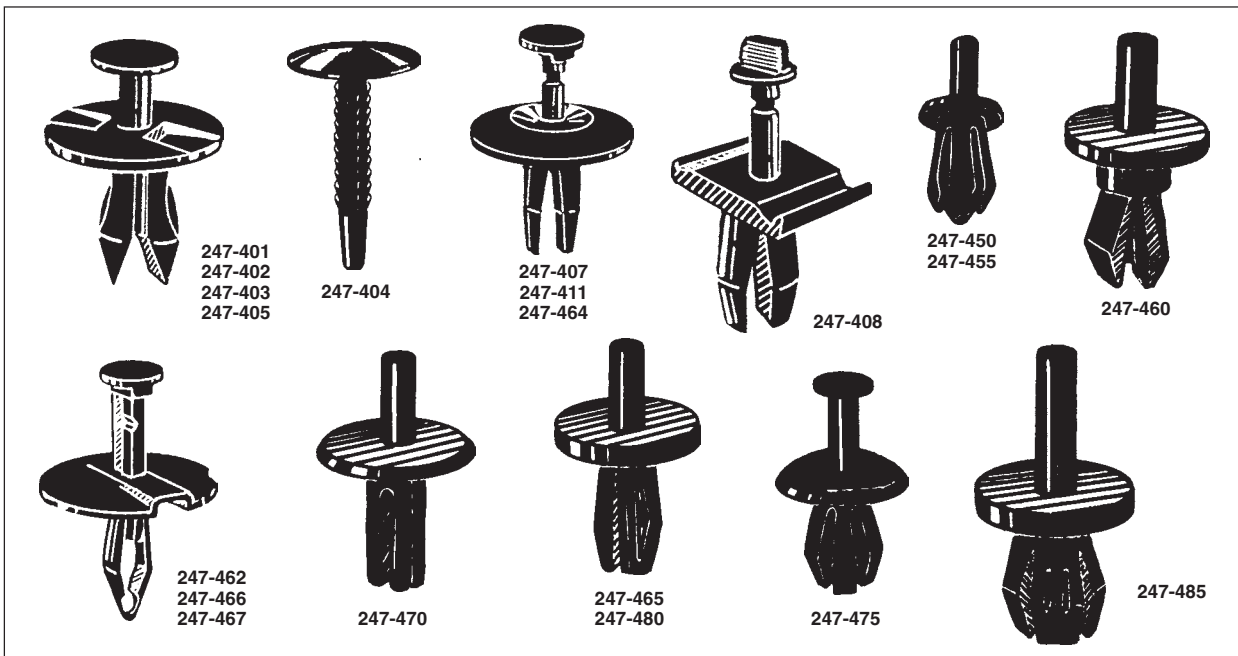

Stock No.	Factory No.	Application	Stock No.	Factory No.	Application
247-401*	5973400	GM Fascia	247-460	387944-S	Ford Grille to Metal Stamping
247-402	5973823	GM Fascia (Blue)	247-462	N802781-S	Ford, GM Splash Shield and Fascia
247-403	5973996	GM Body (Brown)	247-464	N805231-S	Ford Grille Opening Reinforcement
247-404	20590899	GM Exterior Body	247-465	387843-S	Ford Fender Shield
247-405	14045480	GM Fascia	247-466	N803362-S	Ford, GM Body
247-407	14019206	GM Fender Liner		20510029	
247-408	14032200	GM Grille Attachment	247-467	6501590	Chrysler, Ford Splash Shield and Fascia
247-411	14019226	GM Rad Overflow and	247-470	383142-S	Ford Grille to Headlamp Bracket
	14071289	Windshield Washer Reservoir	247-475	6031383	Chrysler Grille
247-450	14005089	GM A/C Vents General Purpose	247-480	6031390	Chrysler Plastic Inner Fender
247-455	10017619	GM Front Bumper Grille Bar	247-485	6031548	Chrysler Bumper Strip



248
Series



HEADLAMP ADJUSTING SCREWS VIS DE PHARES REGLAGE

Order by Stock Number

Illustrations Actual Size

Standard Packages 10 pieces

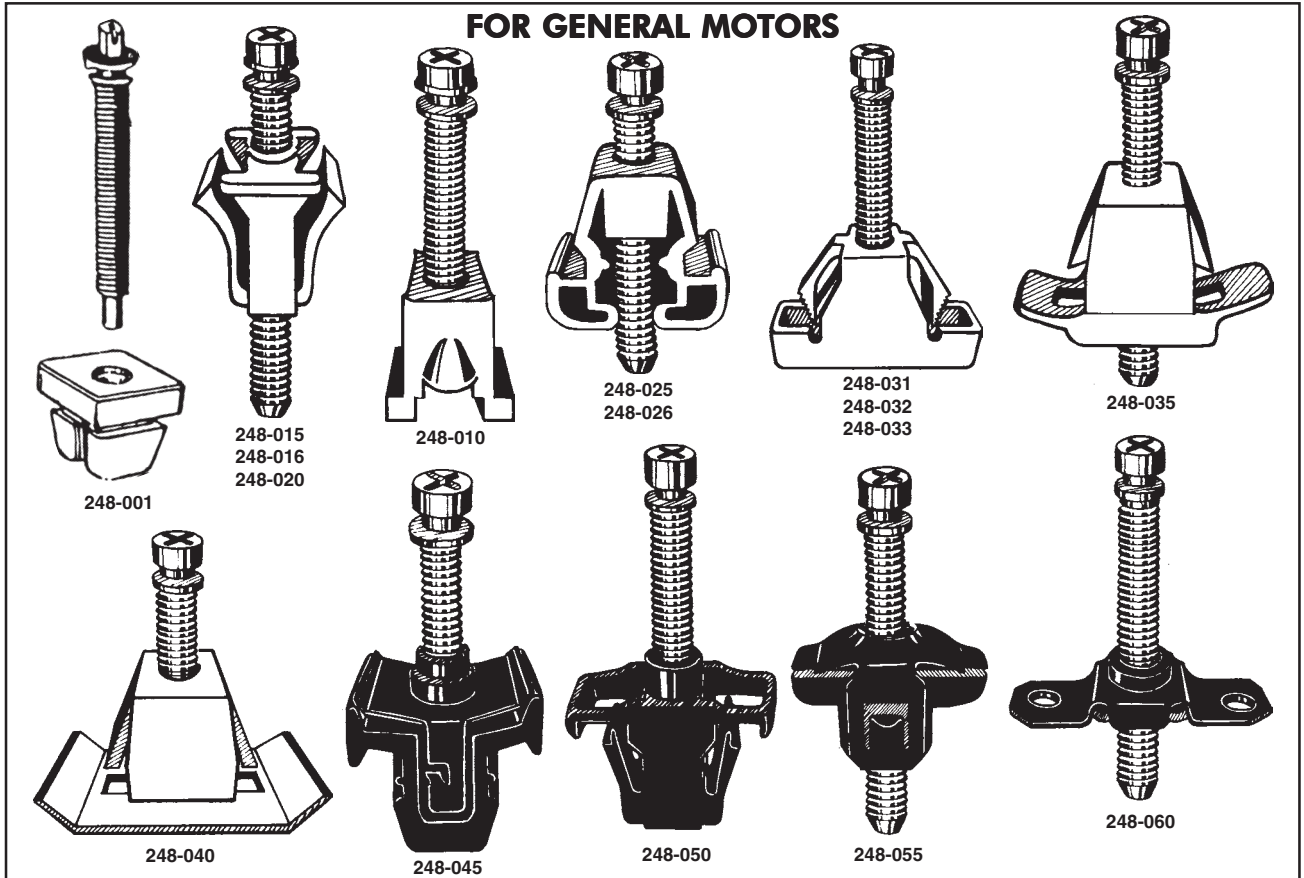

Stock No.	Factory No.	Application	Screw Dia. x Length
248-001	3921446 (nut)	GM Headlamp Adjusting Screw and Nut	1/4-28x1-1/2"
248-010	—	Chevrolet All Early Models (White Nut)	1/4-28x1-1/2"
248-015	354076, 343543	Chevrolet, Buick (White Nut)	1/4-28x2"
248-016	365270	GM Fiberglass Panels (Green Nut)	1/4-28x2"
248-020	365266	Chevrolet Fiberglass Panels (Green Nut)	1/4-28x2"
248-025	1606642, SF4006204	Olds, Cadillac, AMC (Pink Nut)	1/4-28x1-7/8"
248-026	1600375	Cadillac (Pink Nut)	1/4-28x1-1/2"
248-031	556539	Buick, Olds (Black Nut)	12-28x1-3/8"
248-032	556196	Buick, Olds (White Nut)	12-28x1-3/8"
248-033	557057	GM (Blue Nut)	12-28x1-3/4"
248-035	553799	Buick, Olds	1/4-28x1-3/8"
248-040	413852	Oldsmobile	1/4-28x1"
248-045	1493541	Buick, Cadillac, Pontiac	1/4-28x1-1/2"
248-050	500267	Chevrolet, Pontiac	1/4-28x1-5/8"
248-055	1235816	Buick, Cadillac	1/4-28x1-1/2"
248-060	—	GM	1/4-28x1-5/8"

MASTER ASSORTMENT No. 020-675

For General Motors

Contains 50 Headlamp Adjusting Screws and Nuts for General Motors. Packed in a metal box with high-strength plastic compartments complete with actual size illustrations and retail price codes on a grease-resistant lid label.



MASTER ASSORTMENT No. 020-676

For Ford and Chrysler

Contains 50 Headlamp Adjusting Screws and Nuts for Ford and Chrysler Products. Packed in a metal container with moulded, plastic compartments. Actual size illustrations and retail codes shown on lid label.



Order by Stock Number

Illustrations Actual Size

Standard Packages 10 pieces

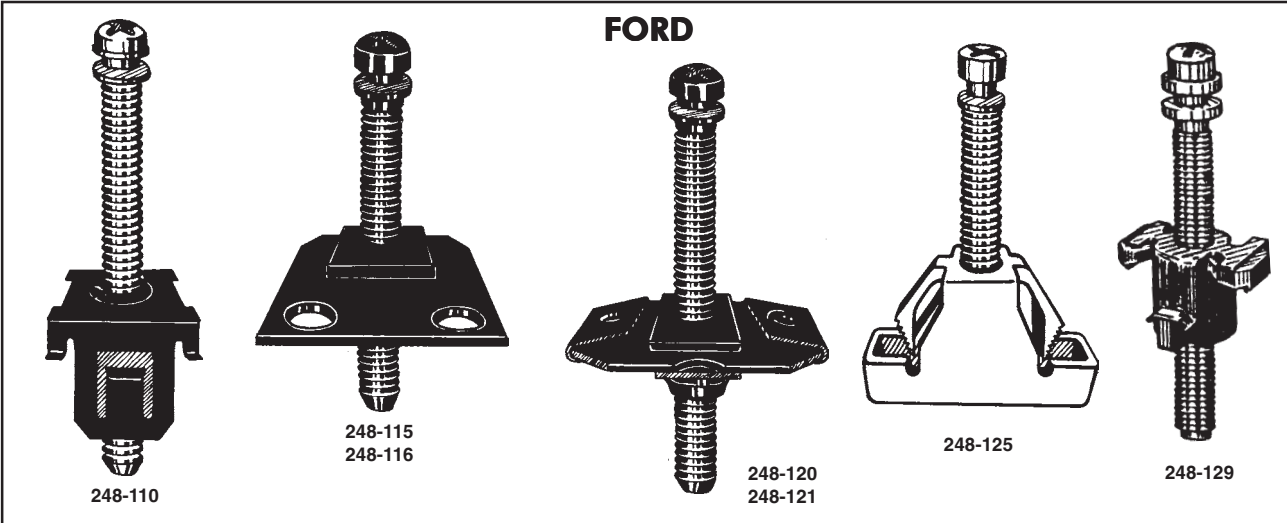

Stock No.	Factory No.	Year	Application	Screw Dia. x Length
248-110	D7AB-13A093-AA	1977-up	Ford Cars, Light and Medium Trucks	12-28 X 1-3/4
248-115	D3HB-13A093-AB	1977-up	Ford Cars, Mustang II and Heavy Trucks	1/4-28 X 1-3/4
248-116	D7SZ-13032-A	1968-74	Ford Products	1/4-28 X 1-3/4
248-120	D70B-13A-093-AA	1976-up	Ford Products	1/4-28 X 1-3/4
248-121	DZ0B-13A-093-AA	1976-up	Ford Cars and Medium Trucks	1/4-28 X 1-1/2
248-125	D8-BB-13M-093-AA	1978-up	Ford Products	12-28 X 1-3/8
248-129	D9ZB-13A-093-AA	1978-up	Ford Products	12-28 X 1-3/4

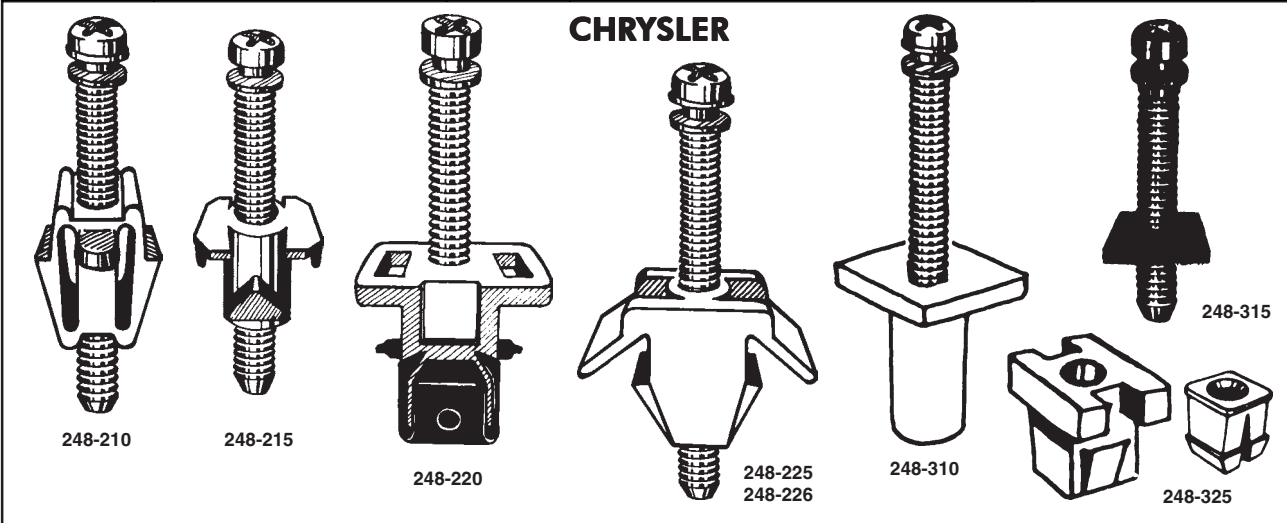

Stock No.	Factory No.	Year	Application	Screw Dia. x Length
248-210	3574085	1972-up	All Chrysler Inc: Dodge and Plymouth	12-28 x 1-1/2
248-215	3691599	1975-77	All Chrysler Inc: Dodge and Plymouth	12-28 x 1-1/2
248-220	2785842	All	Chrysler Inc: Dodge and Plymouth	12-28 x 1-1/2
248-225	3868985	1977-up	All Chrysler Inc: Dodge and Plymouth	12-28 x 1-1/2
248-226	5201359	1978-up	All Chrysler Inc: Dodge and Plymouth	12-28 x 2-1/8
248-310	—	All	Nissan	12-28 x 1-1/2
248-325	—	All	Toyota	12-28 x 1-1/2

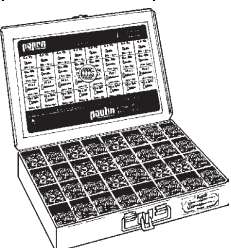

papeo

SUPER SERVICE ASSORTMENT No. 020-815

Contains 105 Headlamp Adjusting Screws and Nuts for GM, Ford and Chrysler - 32 items.
Large size, rigid metal box with high-strength plastic compartments.

For more details see page 9.

Large size: 12" w. x 18" l. x 3" d.



249
Series

papco

**UTILITY SCISSORS
CISEAUX FONCTIONNEL**

No. 249-120

Professional quality features stainless steel blades with long-lasting ground edges and high-impact, man-size ABS plastic handles. Individually packaged on 'try-me' blister card.



WORK·SAUVERS®

papco

**UTILITY SHEARS
CISAILLES FONCTIONNEL**

No. 249-130

Professional quality, stainless steel blades with long-lasting edges. High-impact handles with safety lock. For wire, thin sheet metal, shim stock, vinyl, fibreglass and more. Individually carded.

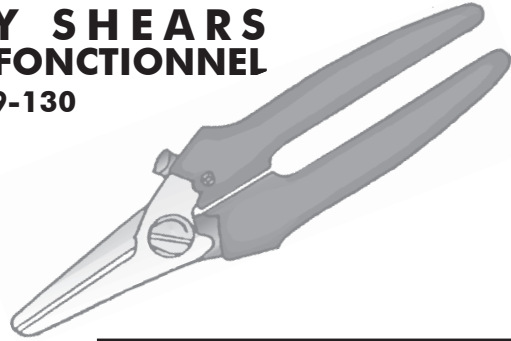

papco

**UTILITY SCRAPERS
GRATTIORS FONCTIONNEL**

'Papco' Utility Scrapers are ideal for trimming, cutting, splicing, scraping paint or stickers. Choose from the retractable, pocket size or standard, angled head for hard-to-reach places - both use either steel or plastic razor blades.



No. 249-124
Angled Head
for hard-to-reach places

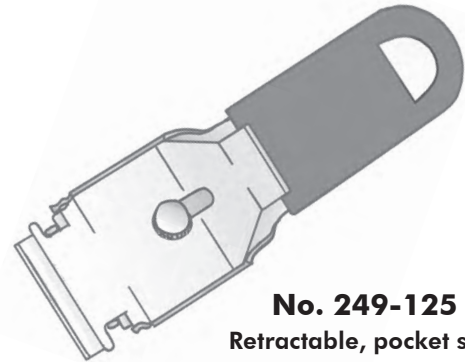

No. 249-125
Retractable, pocket size

papco

**REPLACEMENT BLADES
LAMES DE RECHANGE**

No. 249-126 STEEL RAZOR BLADES



Single edge, industrial duty steel replacement blades for No. 249-124 and 249-125 utility scrapers. Skin packed card contains 10 blades in a recloseable box.

No. 249-127 PLASTIC RAZOR BLADES

For cleaning sun film or laminated glass without cutting or nicking. Fits both 'Papco' Utility Scrapers. Skin packed card contains 100 blades in a recloseable box.

314
Series

papco

**PLASTIC PLUG BUTTONS
BOUCHONS EN PLASTIQUE**

'Papco' Plastic Plug Buttons are used for plugging unsightly body holes after removing accessories, rust-proofing or body repair.

BLACK VINYL



Stock No.	Size	Std. Pkg.
314-318	3/8" Diameter	100
314-322	1/2" Diameter	100
314-326	3/4" Diameter	100
314-328	7/8" Diameter	100
314-330	1" Diameter	100



Consider these important features:

- All metal cabinet for long-life
- Fully illustrated, colour-coded label for speedy selection
- Unique inventory control system
- Refills available from your nearest 'Papco' Jobber

Now for the first time ever the most efficient way of having the right Body Shop Fasteners - where you need them - when you need them!

The coverage selected by professional body men across the country, after months of research, is finally here. All the right parts such as Trim Screws, Body Bolts, Nuts, 'Plastic-Rivets', Trim Fasteners and more - for import and domestic cars and trucks.

The 105 fastest movers in three (3) easy-to-use metal cabinets that keep parts neatly organized and free of dust. The most popular car and truck coverage of Body Shop Fasteners today! A necessity for every body repair outlet.

No. 022-217 Body Shop Clips Merchandiser								
Qty.	Part No.	Description	Qty.	Part No.	Description	Qty.	Part No.	Description
25	247-024	Trim Fasteners	25	247-406	'Plastic' Rivets	25	247-822	Anchor Nuts
25	247-074	Trim Fasteners	25	247-407	'Plastic' Rivets	25	247-830	Anchor Nuts
25	247-080	Trim Fasteners	25	247-411	'Plastic' Rivets	25	247-854	Anchor Nuts
25	247-085	Trim Fasteners	25	247-462	'Plastic' Rivets	25	247-855	Anchor Nuts
25	247-210	Trim Fasteners	25	247-490	'Plastic' Rivets	10	248-020	Headlamp Screws
50*	247-211	Trim Fasteners	25	247-494	'Plastic' Rivets	10	248-031	Headlamp Screws
25	247-216	Trim Fasteners	25	247-715	Anchor Grommets	10	248-226	Headlamp Screws
10*	247-249	Trim Fasteners	25	247-810	Anchor Nuts	25	250-550	Door Hinge Bushings
25	247-308	Nylon Rivets	25	247-815	Anchor Nuts	25	250-553	Door Hinge Bushings
15	247-401	'Plastic' Rivets	25	247-819	Anchor Nuts	2	250-559	Door Hinge Pins
25	247-405	'Plastic' Rivets	25	247-821	Anchor Nuts	5x5	997-594	Panel Drill Bits

*Quantity represents two boxes

No. 022-218 Body Bolts and Retainers Merchandiser								
Qty.	Part No.	Description	Qty.	Part No.	Description	Qty.	Part No.	Description
25	241-606	Metric 'U' Nuts	100	242-322	Bolt Retainers	25	245-407	Body Bolts
25	241-607	Metric 'U' Nuts	100	243-306	Metric Bolt Retainers	25	245-408	Body Bolts
25	241-608	Metric 'U' Nuts	100	243-308	Metric Bolt Retainers	25	245-420	Body Bolts
25	241-609	Metric 'U' Nuts	25	244-957	Metric Washer Nuts	25	245-440	Body Bolts
10	241-610	Metric 'U' Nuts	25	244-986	Metric Washer Nuts	10	245-450	Body Bolts
50	242-206	Palnuts	25	244-987	Metric Washer Nuts	25	245-505	Body Bolts
50	242-210	Palnuts	25	244-988	Metric Washer Nuts	25	245-525	Body Bolts
50	242-215	Palnuts	12	245-165	Bumber Bar Bolts	25	245-527	Body Bolts
50	242-216	Palnuts	12	245-172	Bumber Bar Bolts	25	250-363	Body Shims
100	242-314	Bolt Retainers	6	245-183	Bumber Bar Bolts	25	250-371	Body Shims
100	242-316	Bolt Retainers	10	245-220	Bumber Bar Bolts	25	250-372	Body Shims
100	242-318	Bolt Retainers	25	245-400	Body Bolts			

No. 022-219 Trim Screws Merchandiser								
Qty.	Part No.	Description	Qty.	Part No.	Description	Qty.	Part No.	Description
100	213-278	Hex Tapping Screws	100	229-405	Washer Head Trim Scr.	100	229-982	Pan Trim Screws-Black
50	213-444	Hex Tapping Screws	50	229-855	Oval Sems - Black	100	230-302	Metric Screw
100	229-122	Pan Trim Screws - Zinc	100	229-911	Oval Trim Screws - Black	100	230-303	Metric Screw
100	229-124	Pan Trim Screws - Zinc	100	229-915	Oval Trim Screws - Black	100	230-305	Metric Screw
100	229-144	Pan Trim Screws - Zinc	100	229-919	Oval Trim Screws - Black	100	230-306	Metric Screw
100	229-164	Pan Trim Screws - Zinc	100	229-923	Oval Trim Screws - Black	100	240-228	Speed Nuts
100	229-222	Oval Trim Screws - Zinc	100	229-933	Oval Trim Screws - Black	25	240-708	'U' Nuts
100	229-224	Oval Trim Screws - Zinc	100	229-937	Oval Trim Screws - Black	25	240-709	'U' Nuts
100	229-226	Oval Trim Screws - Zinc	100	229-960	Pan Trim Screws - Black	25	240-710	'U' Nuts
100	229-228	Oval Trim Screws - Zinc	100	229-968	Pan Trim Screws - Black	100*	245-906	Lic. Plate Bolts
100	229-242	Oval Trim Screws - Zinc	100	229-972	Pan Trim Screws - Black			
100	229-244	Oval Trim Screws - Zinc	100	229-980	Pan Trim Screws - Black			

*Quantity represents two boxes



CARDED BODY SHOP FASTENERS MERCHANDISERS

CARDED

HEADLAMP SCREW MERCHANDISER No. 022-122

Includes Rack, Header Sign, Inventory Control Strips, Planogram and a 20 card starter stock of the items listed below.

Card No.	Cat. No.	Description	Pcs/Card	Card No.	Cat. No.	Description	Pcs/Card
248-601	248-001	GM Universal	2	248-721	248-121	'73 up Ford	2
248-605*	248-005	'75 up GM	2	248-729	248-129	'79 up Ford	2
248-606	248-125	'78 up GM, Ford	2	248-805	248-205	'78 up Chrysler	2
248-620	248-020	'76 up GM	2	248-810	248-210	'70 up Chrysler	2
248-625	248-025	'75 up GM	2	248-820	248-220	'68 up Chrysler	2
248-635*	248-035	'75 up GM	2	248-910	248-310	Datsun	2
248-645	248-045	'69 up GM	2	248-920	248-320	Honda	2
248-650	248-050	'75 up GM	2	248-925	248-325	Toyota	4
248-710	248-110	'77 up Ford	2	* Indicates item double-pegged			
248-715	248-115	'73 up Ford	2				

CARDED

'PLASTI-RIVET' MERCHANDISER No. 022-140

Includes Rack, Header Sign, Inventory Control Strips, Planogram and a 20 card starter stock of the items listed below.

Card No.	Cat. No.	Description	Pcs/Card	Card No.	Cat. No.	Description
247-320	247-300	5mmx6mm	3	247-517	247-402	GM Rivet
247-321	247-301	6.3mmx10mm	3	247-518	247-403	GM Rivet
247-322	247-302	6.3mmx6mm	3	247-519	247-404	GM Rivet
247-323	247-303	6.3mmx10mm	3	247-520	247-405	GM Rivet
247-324	247-304	6.6mmx5mm	3	247-521	247-406	GM, Ford Rivet
247-325	247-305	6.6mmx5mm	3	247-522	247-407	GM Rivet
247-326	247-306	5mmx4.5mm	3	247-523	247-408	GM Rivet
247-327	247-307	5mmx10mm	3	247-526	247-411	GM Rivet
247-328	247-308	3/16dia. Ford Riv	3	247-530	247-530	GM Rivet
247-516	247-401	GM Rivet	2	247-535	247-535	GM Rivet

CARDED

GM TRIM FASTENER MERCHANDISER No. 022-141

Includes Rack, Header Sign, Inventory Control Strips, Planogram and a 40 card starter stock of the items listed below.

Card No.	Cat. No.	Description	Pcs/Card	Card No.	Cat. No.	Description	Pcs/Card
247-921	247-012	GM	5	247-915	247-210	GM	2
247-902	247-020	GM	4	247-958	247-211	GM	4
247-929	247-056	GM	3	247-959	247-212	GM	4
247-950	247-061	GM	2	247-916	247-215	GM	4
247-908	247-080	GM	4	247-960	247-216	GM	3
247-953	247-082	GM	3	247-920	247-220	GM	2
247-909	247-085	GM	2	247-962	247-222	GM	4
247-935	247-101	GM	2	247-932	247-248	GM	2
247-912	247-150	GM	4	247-941	247-249	GM	2
247-913	247-155	GM	4	247-940	247-250	GM	2

CARDED

'PLASTI-RIVET' and GROMMET MERCHANDISER No. 022-142

Includes Rack, Header Sign, Inventory Control Strips, Planogram and a 20 card starter stock of the items listed below.

Card No.	Cat. No.	Description	Pcs/Card	Card No.	Cat. No.	Description
247-565	247-450	GM Rivet	2	247-964	247-712	GM Grille
247-575	247-460	GM Rivet	2	247-970	247-725	Chrysler Rad
247-577	247-462	Ford Rivet	3	247-971	247-730	Ford Grille
247-579	247-464	Ford Rivet	4	247-977	247-735	GM, Chrysler
247-580	247-465	Ford Rivet	4	247-978	247-810	Ford Headlamp
247-581	247-466	Ford, GM Rivet	4	247-973	247-810	GM Marker Light
247-582	247-467	Ford Rivet	3	247-974	247-815	GM Grille
247-583	247-468	Ford Rivet	2	247-979	247-819	GM
247-585	247-470	Ford Rivet	4	247-981	247-822	Chrysler Headlm.
247-961	247-661	GM Grommet	2	247-975	247-840	1/4-20 Lic. Plate

CARDED

REVEAL WINDSHIELD CLIP MERCHANDISER No. 022-143

Includes Rack, Header Sign, Inventory Control Strips, Planogram and a 40 card starter stock of the items listed below.

Card No.	Cat. No.	Description	Pcs/Card	Card No.	Cat. No.	Description	Pcs/Card
246-959	246-409	GM	5	246-969	246-419	GM	3
246-960	246-410	GM	5	246-970	246-420	GM	4
246-961	246-411	GM	5	246-975	246-425	GM	4
246-962	246-412	Ford	5	246-976	246-426	Ford	3
246-963	246-413	GM	5	246-977	246-427	Ford	3
246-964	246-414	Ford	5	246-978	246-428	Ford	3
246-965	246-415	Ford	3	246-979	246-429	Ford	3
246-966	246-416	Chrysler	2	246-985	246-435	Chrysler	5
246-967	246-417	GM	5	246-986	246-436	Chrysler	5
246-968	246-418	GM	5	246-988	246-438	Chrysler	5

CARDED

MOULDING BOLT MERCHANDISER No. 022-147

Includes Rack, Header Sign, Inventory Control Strips, Planogram and a 40 card starter stock of the items listed below.

Card No.	Cat. No.	Description	Pcs/Card	Card No.	Cat. No.	Description	Pcs/Card
246-902	246-112	Universal	1	246-906	246-398	GM	4
246-912	246-212	GM	1	246-907	246-399	GM	2
246-914	246-214	GM	1	246-400	246-400	Universal	1
246-916*	246-216	GM	1	246-951	246-401	GM	4
246-920	246-218	Ford	1	246-952	246-402	GM	4
246-922	246-222	Ford	1	246-953	246-403	Ford	4
246-918	246-228	Ford	1	246-955	246-405	Chrysler	4
246-903	246-395	GM	4	246-957	246-407	Ford	4
246-904	246-396	GM	4	246-958	246-408	GM	4
246-905	234-397	GM	4	* Indicates item double-pegged			

CARDED

FORD, CHRYSLER TRIM FASTENER MERCHANDISER No. 022-149

Includes Rack, Header Sign, Inventory Control Strips, Planogram and a 40 card starter stock of the items listed below.

Card No.	Cat. No.	Description	Pcs/Card	Card No.	Cat. No.	Description	Pcs/Card
247-922	247-024	Ford	3	247-949	247-149	Ford	2
247-903	247-025	Ford, Chrysler	2	247-957	247-160	Chrysler	4
247-923	247-026	Chrysler	3	247-914	247-165	Ford	4
247-924	247-038	Ford	3	247-938	247-231	Ford	2
247-906	247-050	Chrysler	2	247-943	247-232	Ford	4
247-907	247-055	Ford	2	247-919	247-235	Ford	2
247-951	247-062	Ford	3	247-963	247-236	Chrysler	3
247-952	247-065	Ford	3	247-933	247-238	Chrysler	2
247-911	247-110	Ford	2	247-939	247-245	Ford	2
247-955	247-136	Chrysler	4	247-937	247-253	Ford	2

CARDED

WINDOW HANDLE MERCHANDISER No. 022-152

Includes Hooks, Header Sign, Inventory Control Tags, Planogram and a 22 card starter stock of the items listed below.

Card No.	Cat. No.	Description	Pcs/Card	Card No.	Cat. No.	Description	Pcs/Card
Window Handles							
246-700	-	GM Clear	1	246-791	-	Audi, VW	1
246-701	-	GM Black	1	246-790	-	Ford (Inside)	1
246-702	-	GM, GMC Trucks	1	246-791	-	Chrysler (Outsd.)	1
246-715	-	Ford Clear	1	246-792	-	Chrysler (Outsd.)	1
246-716	-	Ford Black	1	Door Handles			
246-717	-	Ford Dbl.-Prong	1	246-800	-	GM (Clear)	1
246-735	-	Chry. Chrome Ctr	1	246-801	-	GM (Black)	1
246-760	-	Honda Civic	1	246-810	-	Ford (Clear)	1
246-761	-	Honda Exc. Civic	1	246-811	-	Ford (Black)	1
246-770	-	Toyota	1	246-830	-	AMC (Black)	1
246-771	-	Toyota	1	Window Handle Knobs			
				246-840	-	Assl. Hand. Clips	8
				246-895	-	Removing Tool	1

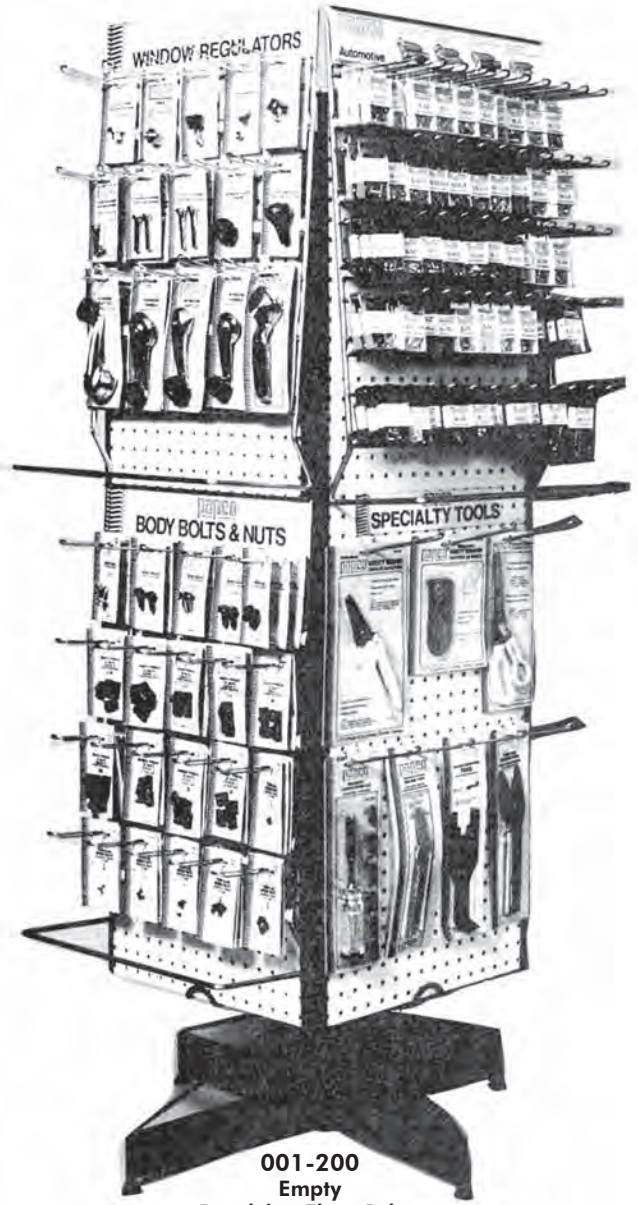

001-200
Empty
Revolving Floor Pylon



250
Series

PAPCO CASTER and CAMBER SHIMS CALES pour CHASSE DIRECTION

"Papco" Shims are used to adjust caster on knee-action and ball-joint suspensions.
All "Papco" shims are plated to resist rust and stamped with thickness or degree.

Order by Stock Number Double Slot Type 6 Pcs. Per Package
Single Slot Type 25 Pcs. Per Package

	<table border="1"> <thead> <tr> <th>Stock No.</th> <th>Thick.</th> <th>°Change</th> </tr> </thead> <tbody> <tr> <td>250-002</td> <td>1/16"</td> <td>1/4°</td> </tr> <tr> <td>250-004</td> <td>1/8"</td> <td>1/2°</td> </tr> <tr> <td>250-006</td> <td>3/16"</td> <td>3/4°</td> </tr> <tr> <td>250-008</td> <td>1/4"</td> <td>1°</td> </tr> </tbody> </table>	Stock No.	Thick.	°Change	250-002	1/16"	1/4°	250-004	1/8"	1/2°	250-006	3/16"	3/4°	250-008	1/4"	1°		<table border="1"> <thead> <tr> <th>Stock No.</th> <th>Thick.</th> <th>Slot</th> </tr> </thead> <tbody> <tr> <td>250-160</td> <td>1/32"</td> <td>9/16"</td> </tr> <tr> <td>250-161</td> <td>1/16"</td> <td>9/16"</td> </tr> <tr> <td>250-162</td> <td>1/8"</td> <td>9/16"</td> </tr> </tbody> </table>	Stock No.	Thick.	Slot	250-160	1/32"	9/16"	250-161	1/16"	9/16"	250-162	1/8"	9/16"						
Stock No.	Thick.	°Change																																		
250-002	1/16"	1/4°																																		
250-004	1/8"	1/2°																																		
250-006	3/16"	3/4°																																		
250-008	1/4"	1°																																		
Stock No.	Thick.	Slot																																		
250-160	1/32"	9/16"																																		
250-161	1/16"	9/16"																																		
250-162	1/8"	9/16"																																		
<p>Universal Type, Fits Many Cars 1-1/4" w. x 3-1/2" l.</p>	<p>3/4 and 1 Ton Chevrolet and GMC Trucks 1963-up 1-1/2" w. x 2-7/16" l.</p>																																			
	<table border="1"> <thead> <tr> <th>Stock No.</th> <th>Thick.</th> <th>Slot</th> </tr> </thead> <tbody> <tr> <td>250-081</td> <td>1/32"</td> <td>1/2"</td> </tr> <tr> <td>250-082</td> <td>1/16"</td> <td>1/2"</td> </tr> <tr> <td>250-083</td> <td>1/8"</td> <td>1/2"</td> </tr> </tbody> </table>	Stock No.	Thick.	Slot	250-081	1/32"	1/2"	250-082	1/16"	1/2"	250-083	1/8"	1/2"		<table border="1"> <thead> <tr> <th>Stock No.</th> <th>Thick.</th> <th>Slot</th> </tr> </thead> <tbody> <tr> <td>250-166</td> <td>.060"</td> <td>19/32"</td> </tr> <tr> <td>250-168</td> <td>.080"</td> <td>19/32"</td> </tr> <tr> <td>250-170</td> <td>.100"</td> <td>19/32"</td> </tr> </tbody> </table>	Stock No.	Thick.	Slot	250-166	.060"	19/32"	250-168	.080"	19/32"	250-170	.100"	19/32"									
Stock No.	Thick.	Slot																																		
250-081	1/32"	1/2"																																		
250-082	1/16"	1/2"																																		
250-083	1/8"	1/2"																																		
Stock No.	Thick.	Slot																																		
250-166	.060"	19/32"																																		
250-168	.080"	19/32"																																		
250-170	.100"	19/32"																																		
<p>General Motors 1971-up 1-3/16" w. x 1-1/8" l.</p>	<p>Buick 1957-up 1" w. x 1-5/8" l.</p>																																			
	<table border="1"> <thead> <tr> <th>Stock No.</th> <th>Thick.</th> <th>Slot</th> </tr> </thead> <tbody> <tr> <td>250-091</td> <td>1/32"</td> <td>17/32"</td> </tr> <tr> <td>250-092</td> <td>1/16"</td> <td>17/32"</td> </tr> <tr> <td>250-093</td> <td>1/8"</td> <td>17/32"</td> </tr> </tbody> </table>	Stock No.	Thick.	Slot	250-091	1/32"	17/32"	250-092	1/16"	17/32"	250-093	1/8"	17/32"		<table border="1"> <thead> <tr> <th>Stock No.</th> <th>Thick.</th> <th>Slot</th> </tr> </thead> <tbody> <tr> <td>250-176</td> <td>1/32"</td> <td>9/16"</td> </tr> <tr> <td>250-177</td> <td>1/16"</td> <td>9/16"</td> </tr> <tr> <td>250-179</td> <td>3/16"</td> <td>9/16"</td> </tr> </tbody> </table>	Stock No.	Thick.	Slot	250-176	1/32"	9/16"	250-177	1/16"	9/16"	250-179	3/16"	9/16"									
Stock No.	Thick.	Slot																																		
250-091	1/32"	17/32"																																		
250-092	1/16"	17/32"																																		
250-093	1/8"	17/32"																																		
Stock No.	Thick.	Slot																																		
250-176	1/32"	9/16"																																		
250-177	1/16"	9/16"																																		
250-179	3/16"	9/16"																																		
<p>Ford 1954-up Meteor 1954-up 1-1/16" w. x 1" l.</p>	<p>Chevrolet and GMC Light Trucks, Series 10-40 1960-up 1-1/4" w. x 2" l.</p>																																			
	<table border="1"> <thead> <tr> <th>Stock No.</th> <th>Thick.</th> <th>Slot</th> </tr> </thead> <tbody> <tr> <td>250-095</td> <td>1/64"</td> <td>19/32"</td> </tr> <tr> <td>250-096</td> <td>1/32"</td> <td>19/32"</td> </tr> <tr> <td>250-097</td> <td>1/16"</td> <td>19/32"</td> </tr> <tr> <td>250-098</td> <td>1/8"</td> <td>19/32"</td> </tr> </tbody> </table>	Stock No.	Thick.	Slot	250-095	1/64"	19/32"	250-096	1/32"	19/32"	250-097	1/16"	19/32"	250-098	1/8"	19/32"		<table border="1"> <thead> <tr> <th>Stock No.</th> <th>Thick.</th> <th>Slot</th> </tr> </thead> <tbody> <tr> <td>250-184</td> <td>1/64"</td> <td>1/2"</td> </tr> <tr> <td>250-185</td> <td>1/32"</td> <td>1/2"</td> </tr> <tr> <td>250-186</td> <td>1/16"</td> <td>1/2"</td> </tr> <tr> <td>250-187</td> <td>1/8"</td> <td>1/2"</td> </tr> <tr> <td>250-188</td> <td>3/16"</td> <td>1/2"</td> </tr> </tbody> </table>	Stock No.	Thick.	Slot	250-184	1/64"	1/2"	250-185	1/32"	1/2"	250-186	1/16"	1/2"	250-187	1/8"	1/2"	250-188	3/16"	1/2"
Stock No.	Thick.	Slot																																		
250-095	1/64"	19/32"																																		
250-096	1/32"	19/32"																																		
250-097	1/16"	19/32"																																		
250-098	1/8"	19/32"																																		
Stock No.	Thick.	Slot																																		
250-184	1/64"	1/2"																																		
250-185	1/32"	1/2"																																		
250-186	1/16"	1/2"																																		
250-187	1/8"	1/2"																																		
250-188	3/16"	1/2"																																		
<p>Lincoln 1952-up Pontiac 1957-up Oldsmob. 1957-up Cadillac 1957-up 1-1/8" w. x 1-3/8" l.</p>	<p>Chevrolet 1971-up Buick, Pontiac 1968-up 1" w. x 1-1/2" l.</p>																																			
<p>*Also Used as Body Shim for Ford Products through 1981.</p>		<table border="1"> <thead> <tr> <th>Stock No.</th> <th>Thick.</th> <th>Slot</th> </tr> </thead> <tbody> <tr> <td>250-192</td> <td>1/64"</td> <td>5/8"</td> </tr> <tr> <td>250-193</td> <td>1/32"</td> <td>5/8"</td> </tr> <tr> <td>250-194</td> <td>1/16"</td> <td>5/8"</td> </tr> <tr> <td>250-195</td> <td>1/8"</td> <td>5/8"</td> </tr> </tbody> </table>	Stock No.	Thick.	Slot	250-192	1/64"	5/8"	250-193	1/32"	5/8"	250-194	1/16"	5/8"	250-195	1/8"	5/8"																			
Stock No.	Thick.	Slot																																		
250-192	1/64"	5/8"																																		
250-193	1/32"	5/8"																																		
250-194	1/16"	5/8"																																		
250-195	1/8"	5/8"																																		
	<table border="1"> <thead> <tr> <th>Stock No.</th> <th>Thick.</th> <th>Slot</th> </tr> </thead> <tbody> <tr> <td>250-105</td> <td>1/64"</td> <td>15/32"</td> </tr> <tr> <td>250-106</td> <td>1/32"</td> <td>15/32"</td> </tr> <tr> <td>250-107</td> <td>1/16"</td> <td>15/32"</td> </tr> <tr> <td>250-108</td> <td>1/8"</td> <td>15/32"</td> </tr> </tbody> </table>	Stock No.	Thick.	Slot	250-105	1/64"	15/32"	250-106	1/32"	15/32"	250-107	1/16"	15/32"	250-108	1/8"	15/32"	<p>Universal 1-3/8" w. x 1-1/4" l.</p>	<table border="1"> <thead> <tr> <th>Stock No.</th> <th>Thick.</th> <th>Slot</th> </tr> </thead> <tbody> <tr> <td>250-196</td> <td>1/32"</td> <td>9/16"</td> </tr> <tr> <td>250-197</td> <td>1/16"</td> <td>9/16"</td> </tr> <tr> <td>250-198</td> <td>1/8"</td> <td>9/16"</td> </tr> </tbody> </table>	Stock No.	Thick.	Slot	250-196	1/32"	9/16"	250-197	1/16"	9/16"	250-198	1/8"	9/16"						
Stock No.	Thick.	Slot																																		
250-105	1/64"	15/32"																																		
250-106	1/32"	15/32"																																		
250-107	1/16"	15/32"																																		
250-108	1/8"	15/32"																																		
Stock No.	Thick.	Slot																																		
250-196	1/32"	9/16"																																		
250-197	1/16"	9/16"																																		
250-198	1/8"	9/16"																																		
<p>Camaro, Chevelle 1967-up Chevrolet 1955-up Pontiac 1955-up Buick 1961-up Oldsmob. 1961-up 15/16" w. x 1-9/16" l.</p>	<p>Oldsmobile 1957-up 1-7/16" w. x 1-3/8" l.</p>																																			

PAPCO UNIVERSAL CASTER and CAMBER SHIMS

Designed to replace single slot shims with a slot width of from 7/16" to 21/32". The slot is tapered allowing shim to drop over stud to correct position. Can be used on most applications now covered by 250-091, 093 series, 250-095, 098 and 250-105, 108 series.



Universal

Standard Package 25 Shims

Stock No.	Thick.	Slot
250-281	1/64"	7/16 to 21/32"
250-282	1/32"	7/16 to 21/32"
250-283	1/16"	7/16 to 21/32"
250-284	1/8"	7/16 to 21/32"

1-3/16" w. x 1-1/2" long





250
Series

papco

BODY SHIMS
CALES DE CARROSSERIE

- Used for alignment of Hoods, Fenders, Cowls and Starter Motors
- Plated Steel - Standard Package Contains 25 Shims

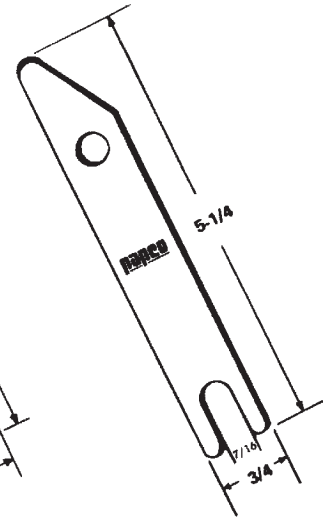
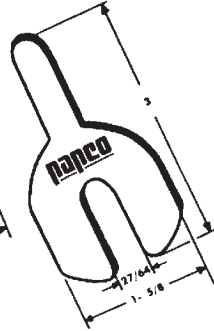
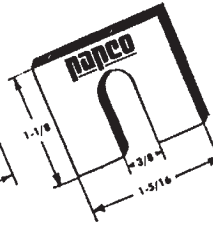
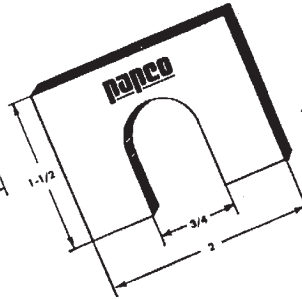
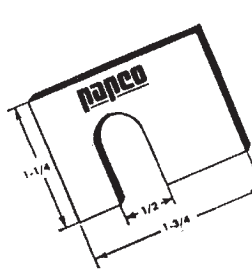

BODY SHIM	
Stock No.	Thickness
250-361	1/32"
250-362	1/16"
250-363	1/8"

BODY SHIM	
Stock No.	Thickness
250-368	1/8"
Ford	

HOOD SHIM	
Stock No.	Thickness
250-371	1/16"
250-372	1/8"
Chevrolet	

FENDER SHIM	
Stock No.	Thickness
250-380	1/16"
250-382	1/8"
GM	

STARTER MOTOR SHIM	
Stock No.	Thickness
250-390	1/64"
250-391	1/32"
250-392	1/16"
GM9785608, 10008053	

papco

BODY ALIGNING SHIM

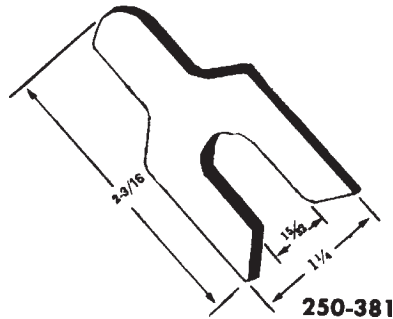

No. 250-381
UNIVERSAL GM APPLICATION

These 1/16" thick steel shims have numerous applications on GM cars. Standard Package contains 25 shims.

250
Series

papco

DOOR HINGE PINS and BUSHINGS
GOUPILLES et BAGUES DE PORTE

'Papco' Door Hinge Pins and Bushings are replacements for original equipment hardware that has worn, been broken or damaged - causing misalignment, sagging or sticking.

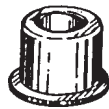

250-549
250-550
250-551
250-552



250-553



250-559



250-560



250-562

Order by Stock Number

Stock No.	Description	Std. Pkg.
250-549	(9716926) (20345137) Door Hinge Bushings .490" O.D.	25
250-550	(9721917) (DIAZ-6522841A) GM, Ford Door Hinge Bushing .419" O.D.	25
250-551	(D902-6522841A) Ford Door Hinge Bushing .479" O.D.	25
250-552	(4033711) Chrysler Door Hinge Bushing .316" O.D.	25
250-553	(20429500) GM Splined Door Hinge Bushing .489" O.D.	25
250-559	(6271989) (20046147) 11/32" x 4 -3/16" GM Door Hinge Pin	2
250-560	(20043351) 11/32" x 4" GM Door Hinge Pin	10
250-562	(6028993) (6032975) 17/64" x 2 -3/4" Chrysler, Vans, Door Hinge Pin	10

251
Series

papeco COIL SPRINGS STABILIZERS STABILISATEURS DE RESSORT

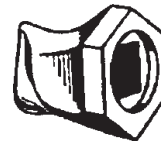

Easily installed with a 1/2" socket drive or open end wrench.
Designed to aid wheel alignment, eliminate front end dip or restore weak coil springs to original position.
Convenient skin-packed card contains four stabilizers. Order by Card Number.



ASSORTMENT DISPLAY No. 020-881

Contains 12 small and 8 large Coil Spring Stabilizers. Attractive three colour display card can be hung on wall or set on counter.

020-881

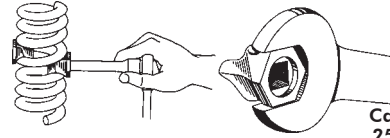

Card No.
251-042

Card No. 251-042
Contains four small type stabilizers for Front Coil Springs.

Card No. 251-044
Contains four large type stabilizers for Front or Rear Coil Springs.



Solid Rubber, Block Type Stabilizers



For front coils only.

Corrects sagging of coil springs, bottoming and side sway.

Convenient skin-packed card contains four stabilizers.

Order by Card Number.

Card No. 251-031 For front coils only.

Card No. 251-057 For rear coils only.



For rear coils springs only.

Complete installation instructions
on back of each card.



Card No.
251-031

Heavy Duty Rubber Stabilizers

Circular Type



For front or rear coils.

Recommended for rough road conditions and heavy duty applications such as taxis and police cars, etc.

Individually carded

Order by Card Number 251-059

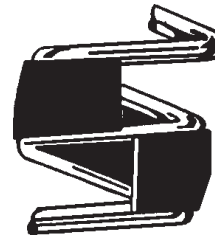

Complete installation instructions
included in each package.

papeco ADJUSTABLE COIL SPRING EXPANDER RELEVEURS DE RESSORT REGLABLE

Expands sagging coil springs for improved riding and steering qualities.
Convenient skin-packed card contains two expanders and complete installation instructions.



Order by Card Number 251-060.



COIL SPRING EXPANDER DISPLAY No. 020-882

Contains 12 Coil Spring Expanders. Mounted on an attractive three colour point of purchase display card. Can be hung or set on counter.

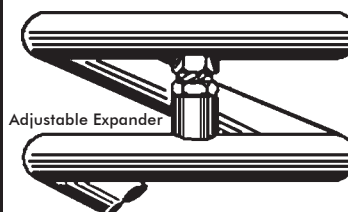

Adjustable Expander





251
Series



SPRING CENTRE BOLTS with NUTS
BOULONS DE CENTRAGE DE RESSORT avec ECROUS



BLACK FINISH

Fillister head, Universal (long) Fine Threads with Hexagon Nut
for all makes of Cars and Trucks (except Ford)

'Papco' Spring Centre Bolts are made of special steel, and are furnished with extra long threads in order to make them universal.

Order by Stock Number

Standard Package 25 Bolts and Nuts

Stock No.	Diameter	Length	Thread Lgth.	Stock No.	Diameter	Length	Thread Lgth.
251-110	5/16	3-1/2	3	251-128	3/8	12	10
251-112	5/16	5	4	251-131	7/16	4	3
251-114	5/16	7	3	251-132	7/16	5	4
251-121	3/8	4	3	251-134	7/16	7	5
251-122	3/8	5	4	251-136	7/16	9	7
251-123	3/8	6	5	251-138	7/16	12	10
251-124	3/8	7	5	251-145	1/2	8	6
251-125	3/8	8	6	251-147	1/2	10	6
251-127	3/8	10	9	251-148	1/2	12	10

111
Series



'POZI-LOK'® DOUBLE NUTS
ECROUS TRES HAUT 'POZI-LOK'®



These Nylon Insert, prevailing torque lock nuts offer excellent vibration resistance and assure positive locking under severe shock. Used for Spring Centre Bolts, Spring U-Bolts etc. UNF Fine Thread.

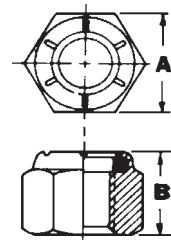

Order by Stock Number

Standard Package 5 Pieces

Stock No.	Size	Dimensions	
		Width "A"	Thickness "B"
111-018	3/8-24	35/64	41/64
111-020	7/16-20	5/8	49/64
111-022	1/2-20	3/4	13/16
111-024	5/8-18	15/16	1"

102
Series



DOUBLE THICKNESS NUTS
ECROUS TRES HAUT

(Light High Nuts)

'Papco' Double Nuts are used on spring centre bolts, spring 'U' bolts, heavy duty truck wheels, tractor and implement bolts. All Double Thickness Nuts have UNF (S.A.E.) Fine Threads.

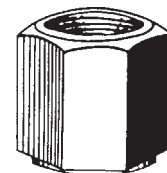

Order by Stock Number

*12 Pieces
Standard Package 24 Pieces

Stock No.	Size	Height	Width	Stock No.	Size	Height	Width
102-018	3/8-24	17/32	9/16	102-026	3/4-16	1"	1-1/16"
102-020	7/16-20	39/64	5/8	102-027	3/4-16	1"	1-1/8"
102-022	1/2-20	11/16	3/4	*102-028	7/8-14	1-5/32"	1-1/4"
102-023	9/16-18	49/64	7/8	*102-030	1-14	1-5/16"	1-7/16"
102-024	5/8-18	27/32	15/16	*102-034	1-1/4-12	1-11/16"	1-13/16"

256
Series

papeo

MUFFLER CLAMPS
COLLIERS DE SILENCIEUX



- Heavy Gauge Steel
- Pipe Size stamped in clamp
- Complete coverage from 1-1/4" to 4" Pipe dia.

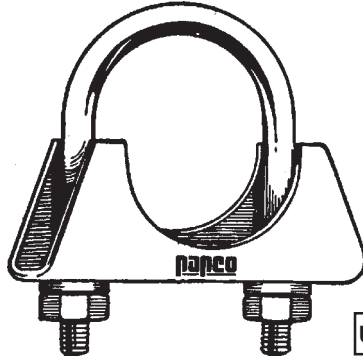

- Full depth saddle for extra strength
- Heavy rolled thread "U" Bolts
- Secure fit between tail pipe and muffler

Use for Inch and Metric applications

"Papco" Muffler Clamps provide a full 360° seal between muffler and pipes. Designed for easier installation and trouble-free service. Assembly consists of heavy gauge saddle, "U" Bolt and two nuts, packed in an individual container.

Order by Stock Number

5/16" Diameter "U" Bolts		
Stock No.	Pipe Size	Metric Equivalent
256-010	1-1/4	32mm
256-012	1-1/2	38mm
256-013	1-5/8	41mm
256-014	1-3/4	45mm
256-015	1-7/8	48mm
256-016	2	51mm
256-017	2-1/8	54mm
256-018	2-1/4	57mm
256-020	2-1/2	64mm

3/8" Diameter "U" Bolts		
Stock No.	Pipe Size	Metric Equivalent
256-114	1-3/4	45mm
256-115	1-7/8	48mm
256-116	2	51mm
256-117	2-1/8	54mm
256-118	2-1/4	57mm
256-120	2-1/2	64mm
256-124	3	76mm
256-128	3-1/2	89mm
256-132	4	102mm

papeo **UNIVERSAL TAILPIPE BRACKETS**
SUPPORT UNIVERSEL DE TUYAU
D' ECHOPPEMENT

Used to suspend exhaust system components such as mufflers, catalytic converters and tailpipes. Brackets No. 256-002 and 256-003 are used with muffler clamps.

Individually Packaged
Order by Stock Number

Stock No.	Size & Description
256-001	6" Steel Strap 1-1/2 - 2-1/2 OD Pipe
256-002	4" Rubber Strap - 4 holes
256-003	7" Steel Strap Swivel end

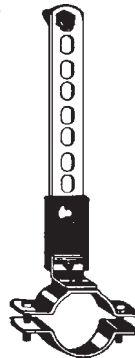

256-001

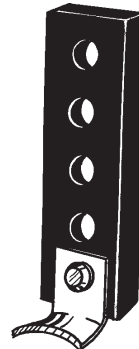

256-002



256-003



papeo **EXHAUST SYSTEM**
FASTENERS ASSORTMENTS

MASTER ASSORTMENT No. 020-639

Contains Cap Screws, Carriage Bolts, Brass and Steel Engine Stud Nuts and Finished Hex Nuts. Gives complete coverage of the most common Exhaust System Fasteners. Sizes and quantities based on popularity.

MASTER ASSORTMENT No. 020-632

Contains manifold studs and brass nuts. For complete listing, see next page.



264
Series

papco

ENGINE STUDS and NUTS
GOUJONS et ECROUS DE MOTEUR

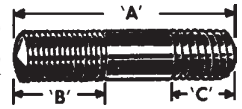

'Papco' Engine Studs will service all popular makes of cars. They have extra long threads and can be cut to size where a shorter stud is required.

Order by Stock Number

Standard Packages 12 pieces

Stock No.	Length Dia. x 'A'	Dimensions		Stock No.	Length Dia. x 'A'	Dimensions	
		'B'	'C'			'B'	'C'
264-016	5/16 x 1-3/4	7/8 UNF	5/8 UNC	264-092	7/16 X 2-1/4	7/8 UNF	7/8 UNC
264-018	5/16 x 2	7/8 UNF	3/4 UNC	264-094	7/16 X 2-3/8	7/8 UNF	5/8 UNC
264-024	5/16 x 2-1/2	1-1/2 UNF	1/2 UNC	264-096	7/16 X 2-1/2	7/8 UNF	3/4 UNC
264-032	5/16 x 3	1-1/2 UNF	5/8 UNC	264-102	7/16 X 3-1/4	1-7/8 UNF	5/8 UNC
264-048	3/8 x 2	1 UNF	3/4 UNC	264-103	7/16 X 3-1/4	1 UNF	3/4 UNC
264-049	3/8 x 2	1 UNC	5/8 UNC	264-108	7/16 X 3-5/8	1-3/4 UNF	5/8 UNC
264-058	3/8 x 2-3/4	1 UNF	3/4 UNC	264-110	7/16 X 4	1-7/8 UNF	5/8 UNF
264-060	3/8 x 3	1-1/4 UNF	3/4 UNC	264-134	1/2 X 2-1/2	1 UNF	3/4 UNC
264-066	3/8 x 4	2 UNC	3/4 UNC	264-140	1/2 X 2-7/8	7/8 UNF	3/4 UNC
264-067	3/8 x 4	2 UNF	3/4 UNC	264-150	1/2 X 4	2 UNF	3/4 UNC
264-086	7/16 x 1-3/4	9/16 UNF	1/2 UNC				
264-088	7/16 x 2	7/8 UNF	3/4 UNC				

METRIC STUDS

Conform to I.S.O. Class 8.8 Specifications. For manifolds, rocker covers and general engine uses.

For Metric Steel Nuts see page 25.

Standard Package 10 Studs

Stock No.	Dia. x Pitch x Length 'A'	'B' mm	'C' mm	Application	Stock No.	Dia. x Pitch x Length 'A'	'B' mm	'C' mm	Application
264-230	M6 x 1.00 x 30mm	14	12	VW-056-103-400	264-440	M8 x 1.25 / M10 x 1.50 x 35mm	14 (M8)	19 (M10)	Universal
264-328	M8 x 1.25 x 28mm	15	10	VWN044-511-1	264-441	M10 x 1.25 x 37mm	13	21	Universal
264-335	M8 x 1.25 x 35mm	17	12	VWN044-514-2	264-443	M10 x 1.25 x 43mm	21	16	DAT14064-N4200
264-338	M8 x 1.25 x 38mm	20	10	VWN14-443-8	264-450	M10 x 1.25 x 50mm	25	15	Universal
264-346	M8 x 1.25 x 46mm	23	16	VWN044-410-2(-4)	264-451	M10 x 1.50 x 50mm	25	15	Universal
264-348	M8 x 1.25 x 50mm	23	10	Universal	264-452	M10 x 1.50 x 52mm	27	12	Universal
264-350	M8 x 1.25 x 55mm	23	10	Universal	264-453	M10 x 1.50 x 62mm	28	12	Universal
264-352	M8 x 1.25 x 60mm	24	10	Universal	264-455	M10 x 1.50 x 65mm	46.5	13.5	Universal
264-354	M8 x 1.25 x 65mm	19	10	Universal	264-457	M10 x 1.50 x 77mm	28	12	Universal
264-356	M8 x 1.25 x 70mm	24	10	Universal					



HEX BRASS NUTS

Stock No.	Size and Thread	Width Across Flats	Thickness
264-953	5/16 UNF	1/2	17/64
264-954	5/16 UNC	1/2	17/64
264-955	3/8 UNF	9/16	21/64
264-956	3/8 UNC	9/16	21/64
264-957	3/8 UNC	9/16	5/8
264-958	7/16 UNF	5/8	3/8
264-959	7/16 UNC	5/8	3/8
264-960	1/2 UNF	3/4	7/16
264-961	1/2 UNC	3/4	7/16

ENGINE STUD and NUT MASTER ASSORTMENT No. 020-632

Contains 80 pieces - 10 sizes.

Will service all exhaust manifold applications. Complete car coverage. All Parts illustrated on hinged lid of sturdy metal merchandiser. Handy carrying handle with snap lock.

HIGH STRENGTH STEEL NUTS

Standard Package 25 Nuts

Stock No.	Size and Thread	Width Across Flats	Thickness
264-903	5/16 UNF	1/2	17/64
264-905	3/8 UNF	9/16	21/64
264-908	7/16 UNF	11/16	3/8
264-909	7/16 UNC	11/16	3/8
264-910	1/2 UNF	3/4	7/16

For 'Papcolloy' Hardened Steel Washers see page 32.

For SUPER-SERVICE ASSORTMENT No. 020-818 Engine Studs and Nuts see page 9.

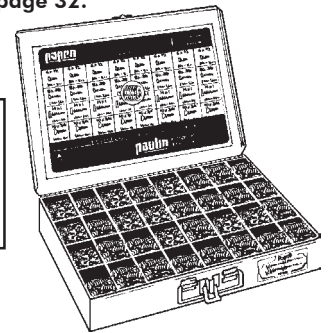

papco

MANIFOLD STUDS
GOUJONS POUR COLLECTEUR

LOW CARBON STEEL

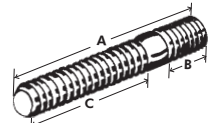

'Papco' Low - Carbon Manifold Studs are easily removed if rusted, broken or stripped. Simply drill out or burn out with a torch. Preferred by muffler shops everywhere. Coarse thread both ends.

Order by Stock Number

Standard Packages 10 pieces

Stock No.	Dia. x Length 'A'	Dimensions		Stock No.	Dia. x Length 'A'	Dimensions	
		'B'	'C'			'B'	'C'
264-504	3/8-16 x 2	5/8 NC	1-1/8 NC	264-519	7/16-14 x 3	5/8 NC	2" NC
264-507	3/8-16 x 2-1/2	5/8 NC	1-1/4 NC	264-523	7/16-14 x 4	5/8 NC	2" NC
264-509	3/8-16 x 3	5/8 NC	2" NC	264-640	M8 x 1.25 x 40	16mm	19mm
264-510	3/8-16 x 3-1/4	5/8 NC	1-5/8 NC	264-650	M10 x 1.5 x 50	16mm	19mm
264-517	7/16-14 x 2-1/2	5/8 NC	1-1/4 NC				

257
Series

PAPCO® CYLINDER HEAD BOLT KITS TROUSE POUR BOULONS DE CULASSE



'Papco' Cylinder Head Bolts are made of high-strength Grade 8 steel. Original bolts may be permanently stretched when torqued to specifications and should be replaced. Torque-to-yield bolts MUST be replaced to avoid premature head gasket failure.

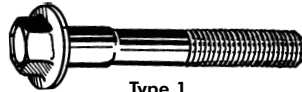

Type 1

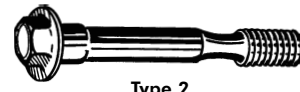

Type 2

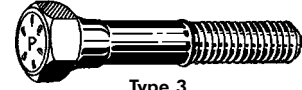

Type 3



Type 4

Order by Kit Number

Type	Year	Cyl.	Engine Size	Size	Kit No.	Trq. to Yield	Pcs. /Kit	Factory No.	
CHRYSLER									
1	1981-up	(4)	2.2L (135), 2.5L (153)	M11 X 1.5 X 120	257-301	Yes	10	6501433	
1†	1987-up	(6)	3.0L (181) SOHC (Mits.)	M12 X 1.25 X 102	257-303	Yes	16	MD065959	
1	1993-up	(6)	3.5L	1/2-13 X 1-7/8	257-304	Yes	16	6502665	
1	1957-up	(8)	All	(Short)	257-305	No	10	6031045	
1				(Medium)		No	8	6031101	
1				(Long)		No	2	2463260	
FORD									
1	1981-94	(4)	1.6L, 1.9L Escort	M10 X 1.5 X 130	257-310	Yes	10	E4FZ-6065-A	
1	1974-95	(4)	2.3L (140), OHC	M12 X 1.75 X 100	257-311	No	10	D4FZ-6065-A	
1	1986-up	(6)	2.9L (177), 4.0L (244) Truck	M12 X 1.75 X 73	257-312	Yes	16	E6TZ-6065-A	
1	1986-up	(6)	3.0L (183) Exc: SHO	M11 X 1.5 X 102	257-313	Yes	16	E8DZ-6065-A	
2	1982-up	(6)	3.8L (232)	(Short)	257-315	Yes	8	F4SZ-6065-B	
2				(Long)		Yes	8	F4SZ-6065-A	
1	1991-up	(8)	4.6L (281) SOHC	M11 X 1.5 X 210	257-316	Yes	20	F5AZ-6065-A	
2	1980-95	(8)	4.9L (300)	7/16-14 X 4	257-317	Yes	14	F3ZZ-6065-B	
2	1970-up	(8)	5.0L (302)	(Long)	257-318	Yes	10	F3ZZ-6065-B	
2				(Short)		Yes	8	F3ZZ-6065-C	
4				(w/stud)		Yes	2	F3ZZ-6065-D	
3	1970-up	(8)	5.8L (351) Windsor	(Short)	257-319	No	20	C902-6065-A	
3				(Long)		No	20	C902-6065-B	
GENERAL MOTORS									
1	1985-95	(4)	1.6L (98) 4, 5, 6 Geo	M10 X 1.5 X 94	257-331	Yes	10	96061591	
3	1982-94	(4)	1.8L, 2.0L, OHC H, K, M	M11 X 1.5 X 140	257-332	Yes	2	10031210	
4				(w/stud)		M11 X 1.5 X 185	Yes	4	10031213
4				(w/stud)		M11 X 1.5 X 165	Yes	4	10031214
1	1987-93	(4)	2.3L (138) QUAD IV DOHC	M12 X 1.75 X 83	257-334	Yes	2	22531281	
1				(Long)		M12 X 1.75 X 98	Yes	8	22531282
4	1980-up	(4)	2.5L (151) A, E, 5, R, 2 (w/stud)	M11 X 1.5 X 125	257-336	Yes	1	12338010	
4				(w/stud)		M11 X 1.5 X 99	Yes	1	12338012
1						M11 X 1.5 X 99	Yes	8	12337818
1	1987-96	(6)	2.8L (173) W, 3.1L (189) VIN T	M11 X 1.5 X 78 **	257-338	Yes	8	10100033	
1						M11 X 1.5 X 108	Yes	8	10227593
1	1982-95	(6)	2.8L (173), 3.1L (189) M, T, W	M11 X 1.5 X 68	257-339	No	8	476572	
1						M11 X 1.5 X 93	No	8	476543
3	1975-up	(6)	3.8L (231) A, B, G, 2, 3, 7, 8, 9, C, L	7/16-14 X 2-11/16	257-340	No	8	1243262	
1						7/16-14 X 3-1/2	No	8	1253539
3	1955-up	(6-8)	4.3L (262) Z, 305, 327, 350, 400	7/16-14 X 3-3/4 *	257-341	No	14	14082317	
3						7/16-14 X 1-3/4 *	No	16	14082316
3						7/16-14 X 3 *	No	4	14082315
1	1982-up	(8)	6.2L (381), 6.5L (395) Diesel	7/16-14 X 3	257-342	No	34	14077193	
1	1971-up	(8)	366, 427, 454 Truck	(Long)	257-343	No	8	10141204, 3877668	
1				(Short)		No	24	10141205, 3877669	

† Round Head

* with GM 9985490 Thread Sealant ** with GM 6124M Thread Sealant

257
Series

PAPCO® STARTER BOLTS BOULONS A DEMARREUR

These hexagon washer head medium carbon steel plated bolts are replacements for damaged or missing starter mounting bolts.

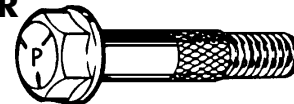

Order by Stock Number

Standard Package 5 Pieces

Stock No.	Size	Application	Stock No.	Size	Application
257-005	3/8-16 x 1-5/16	GM 4.4, 5.0 & 5.7 lit.	257-055	M10 x 1.5 x 45	GM 2.0, 2.5 & 3.4 lit.
257-007	3/8-16 x 1-7/8	GM 3.8 lit., 6 cyl.	257-060	M10 x 1.5 x 102	GM 2.8 & 3.1 lit.
257-012	3/8-16 x 3-5/8	GM 6 & 8 cyl.	257-065	M10 x 1.5 x 113	GM 2.0, 2.5 & 3.4 lit.
257-015	3/8-16 x 4-5/16	GM 4.4, 5.0 & 5.7 lit.	257-070	M10 x 1.5 x 118	GM 2.0, 2.2, 2.5, 2.8, 3.1 & 3.4 lit.
257-017	3/8-16 x 4-1/2	GM 4.3 & 5.0 lit.			
257-018	3/8-16 x 4-5/8	GM 5.0 & 5.7 lit.			



257
Series

PAPCO ALTERNATOR BOLTS BOULONS DE ALTERNATEUR

These high-strength, heat treated plated bolts are used as alternator mounting bolts on domestic and imported vehicles.



Order by Stock Number

Standard Package 5 Pieces

Stock No.	Size	Application	Stock No.	Size	Application
257-105	5/16-18 x 1-1/4	Universal	257-120	3/8-16 x 6	GM
257-110	5/16-18 x 5	GM	257-125	7/16-14 x 5-1/2	Ford
257-115	3/8-16 x 3-1/8	GM	257-155	M10 x 1.5 x 80	GM
257-118	3/8-16 x 4	Chrysler	257-160	M10 x 1.5 x 105	GM

263
Series

PAPCO DRAIN COCKS ROBINETS DE VIDANGE

'Papco' Plastic Drain Cocks for low pressure applications. For water, air, gas, anti-freeze and other fluids. (Not intended for natural gas, LPG or lubricants.)

Order by Stock Number

Standard Package 5 Pieces

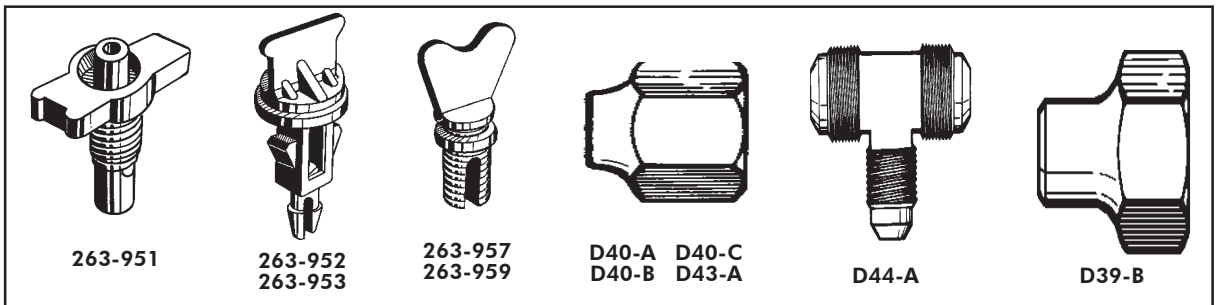

PLASTIC DRAIN COCKS			BRASS DRAIN COCKS		
Stock No.	Size	Factory No. Appl.	Stock No.	Pipe Size	Type
263-951	5/16 (7/16-20)	GM: 3042160	D40-A	1/8	Back Seating
263-952	1/4x1-1/2	GM: 305104 FORD: E1FZ-8115A	D40-B	1/4	Back Seating
263-953	1/4x1-7/8	FORD: E57H-B115A	D40-C	3/8	Back Seating
263-957	10mm x 1.25	NISSAN: 21480-RD100 SUBARU: 7451-24010	D43-A	1/8	Outlet Fitting
263-959	14mm x 1.25	TOYOTA: 90910-09054 HONDA: 19011-PA004	D44-A	1/8	Outlet Fitting
			D39-B	1/4	External Seating

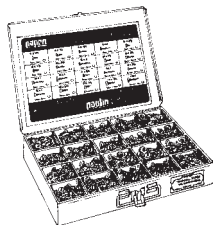

DRAIN COCK MASTER ASSORTMENT No. 020-606

Contains 119 pieces of Plastic and Brass Drain Cocks - plus Compression Sleeves, Nuts, Unions and four sizes of Hex Head Pipe Plugs.

- All Metal box with hinged lid and handy carrying handle.
- Plastic, moulded compartmentized tray.
- Illustrated lid label with retail price codes and refill stock numbers.

DRUM FAUCET No. 913-026

Individually Packaged

For use with oils, kerosene, gasoline, naphtha, alcohol, lacquers, varnishes, thinners, solvents of all kinds, anti-freeze solutions and other liquids, hot or cold.

The 'Papco' Sette Faucet is simple in design and has an all nylon seat for extended life.

Extra thin liquids that are impossible to hold with ordinary faucets are held absolutely and permanently tight by 'Papco' Sette Faucets.

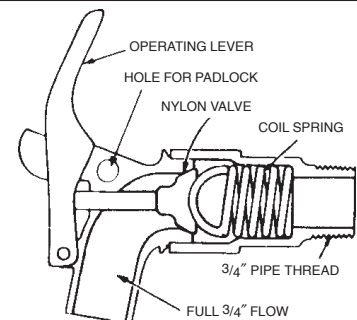



Also known as Frost Plugs, Welsh Plugs or Freeze-Out Plugs.

"Papco" Expansion Plugs are made of heavy gauge plated steel or solid brass to resist rust.

Aussi connus "Frost Plugs", "Welsh Plugs", "Freeze-Out Plugs". Les bouchons d'expansion "Papco" sont fabriqués d'acier épais et plaqués ou laiton massif pour résister à la rouille.



STANDARD TYPE / TYPE REGULIER

Standard Package / Contenant Régulier: 3/8-15/8 = 25 pcs. 147/64-3 = 12 pcs.

Stock No. STEEL	Stock No. BRASS	Nominal Plug Size	Reference O.D.+/- .005	Stock No. STEEL	Stock No. BRASS	Nominal Plug Size	Reference O.D.+/- .005
260-006	260-506	3/8	.375	260-042		1 5/16	1.313
260-008		7/16	.437	260-045	260-545	1 3/8	1.375
260-010	260-510	1/2	.500	260-048		1 7/16	1.437
260-012		9/16	.563	260-051		1 31/64	1.484
260-014		5/8	.625	260-054		1 1/2	1.500
260-016		11/16	.687	260-057	260-557	1 5/8	1.625
260-018	260-518	3/4	.750	260-060		1 47/64	1.734
260-020		13/16	.812	260-063	260-563	1 3/4	1.750
260-022		27/32	.844	260-066	260-566	1 7/8	1.875
260-024	260-524	7/8	.875	260-069	260-569	2	2.000
260-026		15/16	.936	260-072		2 1/16	2.063
260-028	260-528	1	1.000	260-075	260-575	2 7/64	2.105
260-030		1 1/32	1.031	260-078		2 1/4	2.250
260-032		1 1/16	1.063	260-081		2 1/2	2.500
260-034	260-534	1 1/8	1.125	260-084		2 3/4	2.750
260-036		1 3/16	1.188	260-087		3	3.000
260-039	260-539	1 1/4	1.250				

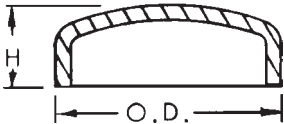

Plated Steel or Solid Brass/Acier Plaqué ou laiton massif

CUP TYPE / TYPE D'ASSIETTE

Standard Package / Contenant Régulier = 12 pcs.

Stock No. STEEL	Stock No. BRASS	Nominal Plug Size	Reference O.D.+/- .005	H - Overall Height	Stock No. STEEL	Stock No. BRASS	Nominal Plug Size	Reference O.D.+/- .005	H - Overall Height
260-100		1/4	0.2600	.135	260-165		1 1/4	1.2580	.437
260-103		5/16	0.3135	.296	260-168		1 3/8	1.3875	.500
260-108		7/16	0.4500	.210	260-171		1 7/16	1.4380	.431
260-110		7/16	0.4445	.156	260-174		1 1/2	1.5220	.375
260-112		29/64	0.4600	.270	260-177		1 1/2	1.5060	.325
260-114		1/2	0.5270	.312	260-180	260-680	1 1/2	1.5075	.625
260-115		1/2	0.5110	.258	260-183		1 9/16	1.5760	.600
260-116		35/64	0.5425	.250	260-186	260-686	1 5/8	1.6375	.593
260-118		9/16	0.5830	.250	260-189		1 41/64	1.6420	.350
260-120		19/32	0.5940	.281	260-192		1 45/64	1.7075	.812
260-121		9/16	0.5710	.250	260-193		1 45/64	1.6380	.350
260-124		5/8	0.6400	.250	260-194	260-694	1 3/4	1.7625	.363
260-125		21/32	0.6580	.266	260-198	260-698	1 3/4	1.7625	.593
260-126		5/8	0.6325	.250	260-204		1 3/4	1.7500	.356
260-128		11/16	0.7000	.250	260-207	260-707	1 49/64	1.7655	.406
260-129		41/64	0.6350	.233	260-210	260-710	1 7/8	1.8925	.447
260-130	260-630	3/4	0.7525	.250	260-213		1 57/64	1.8830	.266
260-132		3/4	0.7625	.265	260-216		1 29/32	1.9020	.600
260-133		51/64	0.7890	.312	260-219	260-719	1 15/16	1.9475	.800
260-134		13/16	0.8120	.312	260-222	260-722	1 61/64	1.9555	.300
260-136		7/8	0.8880	.312	260-224		1 61/64	1.9560	.295
260-138	260-638	29/32	0.9120	.390	260-225		1 63/64	2.0000	.800
260-140	260-640	59/64	0.9250	.335	260-228	260-728	2	2.0090	.635
260-142		15/16	0.9450	.375	260-231		2	2.0080	.415
260-143		61/64	0.9510	.272	260-234	260-734	2 1/64	2.0175	.590
260-144	260-644	1	1.0140	.281	260-237	260-737	2 1/16	2.0675	.510
260-145		1	1.0090	.295	260-240		2 3/32	2.0975	.610
260-146		1 1/16	1.0730	.280	260-243	260-743	2 1/8	2.1450	.430
260-147		1 5/64	1.0720	.280	260-246		2 9/64	2.1485	.600
260-150	260-650	1 1/8	1.1330	.437	260-249		2 3/16	2.1990	.360
260-153		1 13/64	1.2000	.420	260-252	260-752	2 1/4	2.2650	.812
260-156		1 7/32	1.2280	.531	*260-255		2 17/64	2.2640	.355
260-159	260-659	1 1/4	1.2550	.300	260-260		2 1/2	2.5040	.350
*260-162		1 1/4	1.2575	.343	*260-262		2 1/2	2.5000	.340

*With Reverse Taper



260
Series

papco® **EXPANSION PLUGS**
BOUCHONS D'EXPANSION

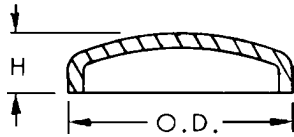

Plated Steel or Solid Brass / Acier plaqué ou laiton massif
SHALLOW CUP TYPE / TYPE D'ASSIETTE PEU PROFOND
Standard Package / Contenant Régulier = 12 pcs.

Stock No. STEEL	Stock No. BRASS	Nominal Plug Size	Reference O.D. +/- .005	H - Overall Height	Stock No. STEEL	Stock No. BRASS	Nominal Plug Size	Reference O.D. +/- .005	H - Overall Height
260-303	260-803	7/16	.440	.170	260-345		1 53/64	1.825	.350
260-305		29/64	.450	.203	260-348		1 29/32	1.915	.265
260-307		1/2	.505	.250	260-351		1 59/64	1.922	.235
260-308		17/32	.541	.187	260-354		1 31/32	1.9775	.218
260-309		35/64	.5425	.187	260-357		2	2.025	.406
260-311		5/8	.631	.190	260-359	260-859	2	2.010	.310
260-312		45/64	.700	.205	260-362		2 1/64	2.0175	.240
260-313		53/64	.8235	.250	260-365	260-865	2 1/16	2.0725	.343
260-315	260-815	1	1.010	.290	260-372		2 7/64	2.109	.310
260-318	260-818	1 1/4	1.2625	.312	260-375		2 9/64	2.135	.360
260-321		1 21/64	1.3225	.281	260-378		2 5/32	2.1535	.328
260-324	260-824	1 3/8	1.385	.340	260-381	260-881	2 3/16	2.200	.355
260-327	260-827	1 1/2	1.505	.300	260-383		2 3/16	2.192	.343
260-330		1 9/16	1.570	.315	260-385		2 7/32	2.2205	.305
260-333	260-833	1 5/8	1.640	.345	260-388		2 1/4	2.262	.350
260-336		1 45/64	1.703	.281	260-391		2 3/8	2.385	.312
260-339	260-839	1 3/4	1.762	.232	*260-394		2 9/16	2.575	.301
260-342		1 51/64	1.8025	.250					

*With Reverse Taper

261
Series

papco® **METRIC EXPANSION PLUGS**
BOUCHONS D'EXPANSION METRIQUE



Plated Steel/
Acier Plaqué

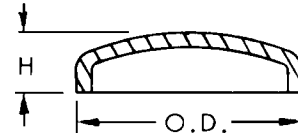

STANDARD TYPE / TYPE REGULIER

Standard Package / Contenant Régulier = 10 pcs.

Stock No.	Nominal O.D.	Stock No.	Nominal O.D.
261-011	16 mm	261-064	40 mm
261-014	18 mm	261-069	42 mm
261-024	24 mm	261-077	45 mm
261-026	25 mm	261-090	52 mm
261-046	35 mm	261-096	55 mm

SHALLOW CUP TYPE / TYPE D'ASSIETTE PEU PROFOND

Standard Package / Contenant Régulier = 10 pcs.

Stock No.	Nominal O.D.	Stock No.	Nominal O.D.
261-326	25 mm	261-367	41.5mm
261-347	35 mm	261-377	45 mm
261-364	40 mm		

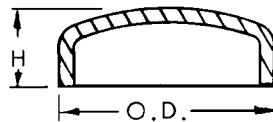

CUP TYPE / TYPE D'ASSIETTE

Standard Package / Contenant Régulier = 10 pcs.

Stock No.	Nominal O.D.	H - Nominal Height (mm)	Stock No.	Nominal O.D.	H - Nominal Height (mm)
261-100	8 mm	4.2	261-146	35 mm	10.6
261-103	11 mm	4.85	261-149	36 mm	8.5
261-105	12 mm	5.3	261-150	36.5 mm	9.0
261-107	14 mm	5.0	261-152	37 mm	10.6
261-108	14.4 mm	5.5	261-155	38 mm	7.9
261-109	15 mm	5.5	261-158	39 mm	9.5
261-111	16 mm	9.1	261-161	40 mm	11.7
261-114	18 mm	5.9	261-162	40 mm	12.8
261-117	20 mm	7.0	261-165	41 mm	11.9
261-118	20 mm	5.4	261-170	42.3 mm	10.0
261-121	22 mm	7.5	261-171	42.6 mm	10.0
261-124	24 mm	6.9	261-173	44 mm	11.9
261-126	25 mm	8.3	261-177	45 mm	11.9
261-129	27 mm	8.4	261-178	45 mm	13.5
261-132	28 mm	8.7	261-181	47 mm	7.4
261-135	29 mm	11.4	261-182	48 mm	11.7
261-138	30 mm	8.1	261-184	49.5 mm	11.0
261-140	31.5 mm	8.5	261-185	50 mm	12.0
261-142	32 mm	9.5	261-186	50 mm	14.8
261-145	34 mm	12.7	261-188	51 mm	5.55

For applications of 'Papco' Expansion Plugs see current catalogue.



260
Series

papeo[®]



STEEL EXPANSION PLUG KITS TROUSSE DE BOUCHON DE ACIER D'EXPANSION

DOMESTIC • IMPORTS • TRUCKS • MARINE

A time-saving kit for machine shops, engine rebuilders and jobbers. Expansion plugs for each engine skin-packed in one convenient package. Coverage for Domestic and Import engines.

DOMESTIQUES • IMPORTÉS • CAMIONS • MARINE

Une trousse qui épargne du temps aux ateliers de mécanique, reconstructeurs de moteurs et revendeurs. Les bouchons d'expansion sont emballés sous un emballage moulant pratique. Ils servent aux moteurs domestiques et importés.

Year	Cyl.	Application	Kit No.	Year	Cyl.	Application	Kit No.
AMC				CHRYSLER/ DODGE			
1984-87	(V6) 173 (2.8L)		260-407	1985-up	(4) 92Q (1.5L)		260-436
1987-97	(V6) 244 (4.0L)		260-401	1981-96	(4) 135 (2.2L) OHC, 153 (2.5L) OHC		260-434
1971-91	(V6) 258 (4.2L)		260-402	1981-91	(4) 156 (2.6L) Mitsubishi		260-435
1970-93	(V8) 360 (5.9L)		260-403	1988-96	(V6) 183 (3.0L)		260-430
BUICK				1990-96	(V6) 201 (3.3L)		260-436
1982-89	(4) 112J,O (1.8L), 121 (2.0L)		260-418	1987-96	(V6) 238 (3.9L)		260-430
1980-93	(4) 151 (2.5L)		260-400	1957-96	(V8) 318 (5.2L), 340 (5.6L), 360 (5.9L)		260-432
1980-93	(V6) 173W,X,Y,Z (2.8L)		260-407	FORD/ FORD TRUCK			
1982-96	(V6) 181E,L (3.0L)		260-406	1981-96	(4) 98 (1.6L) Escort, 116 (1.9L)		260-443
	231A,B,G,2,3,7,8,9 (3.8L)			1974-94	(4) 140 (2.3L) OHC		260-446
1982-85	(V6) 252 (4.1L), 260 (4.3L) Diesel		260-410	1986-96	(V6) 183 (3.0L)		260-448
1977-93	(V8) 305 (5.0L)		260-425	1982-96	(V6) 230 (3.8L)		260-442
1980-91	(V8) 307Y (5.0L), 260 (4.3L) Diesel, 350N Diesel (5.7L)		260-413	1991-96	(V6) 244 OHV		260-452
CADILLAC				1980-96	(V6) 300 (4.9L), 300LD		260-450
1983-91	(4) 121 (2.0L) I,B,P		260-418	1991-96	(V8) 281 (4.6L)		260-457
1985	(V6) 260 (4.3L) Diesel		260-413	1968-96	(V8) 289 (4.7L), 302 (5.0L), 351W (5.8L)		260-451
1988-92	(V6) 273 (4.5L)		260-415	1970-81	(V8) 351 (5.8L), C,M, 400 (6.6L)		260-454
1980-92	(V8) 307Y (5.0L), 350N (5.7L) Diesel		260-413	1973-90	(V8) 370 (6.1L), 429 (7.0L), 460 (7.5L)		260-455
1964-84	(V8) 368 (6.0L), 425,472,500		260-414	HONDA			
CHEVROLET				1975-88	(4) 1342CC,1488CC (1.5L), 1599CC (1.6L)		260-459
1976-88	(4) 98C (1.6L)		260-416	OLDSMOBILE			
1983-91	(4) 121 (2.0L) I,B,P		260-418	1983-94	(4) 112G (1.8L), 121 (2.0L) B,P,I		260-418
1990-96	(4) 134 (2.2L)		260-405	1978-93	(4) 151 (2.5L) 1,5,9,R,V		260-400
1977-92	(4) 151 (2.5L)		260-400	1980-92	(V6) 173 (2.8L) W,X,Z		260-407
1980-92	(V6) 173 (2.8L) W,X,Z,I		260-407	1976-96	(V6) 181 (3.0L) E,L, 231 (3.8L) A,B,C,2,3, 252 (4.1L)		260-410
1979-95	(V6) 231 (3.8L) A,3,8,9		260-410	1975-91	(V8) 260 (4.3L) F,8, 260 (4.3L) Diesel, 307Y (5.0L), 350R (5.7L), 350N (5.7L) Diesel		260-413
1982-85	(V6) 260 (4.3L) Diesel		260-413	1977-96	(V8) 267 (4.4L) J, 305 (5.0L), 350 G,L		260-425
1985-93	(V6) 262Z (4.3L)		260-412	PONTIAC			
1957-95	(V8) 265, 267, 283, 302, (305), 307, 327, 350 to 1996		260-425	1981-87	(4) 98C (1.6L)		260-416
1980-85	(V8) 350N Diesel		260-413	1982-94	(4) 112 (1.8L) J.O, OHC, 112G, 121 (2.0L) B,K,M,P		260-418
CHEVY/ GMC				1977-93	(4) 151 (2.5L) F,R,U,V,I,2,5,9		260-400
1983-84	(4) 121 (2.0L)		260-418	1980-89	(V6) 173 (2.8L) L,S,W,X,Z,1,7,9		260-407
1982-92	(V6) 173 (2.8L)		260-407	1985-96	(V6) 181 (3.0L) E,L, 231 (3.8L) A,B,C,2,3, 252 (4.1L)		260-410
1985-93	(V6) 262N,Z (4.3L)		260-412	1982-85	(V6) 260 (4.3L) Diesel		260-413
1963-91	(V6) 292 (4.8L)		260-415	1977-82	(V8) 265 (4.3L), 301 (4.9L) T,W,Y		260-409
1977-up	(V8) 305 (5.0L), 307 (5.0L), 327 (5.4L)		260-425	1977-93	(V8) 305 (5.0L), 350L (5.7L)		260-425
1969-up	(V8) 350 (5.7L)		260-425	1977-85	(V8) 350R (5.7L), 350N (5.7L) Diesel, 403 (6.6L)		260-413
1978-81	(V8) 350Z (5.7L) Diesel		260-413				
1966-97	(V8) 366 (6.0L), 427 (7.0L), 454 (7.4L)		260-426				
1982-95	(V8) 381 (6.2L) Diesel, 395 Diesel		260-421				



papco EXPANSION PLUGS ASSORTMENTS ASSORTIMENTS DE BOUCHONS D'EXPANSION

GARAGE ASSORTMENT No. 020-048

Contains 50 Standard and
Cup Type Expansion Plugs.



Assortment is packed in rigid, transparent plastic box. See page 3 for contents.



MASTER ASSORTMENT No. 020-666

Contains 120 Metric Standard
and Cup Type Expansion
Plugs in 16 popular sizes.

MASTER ASSORTMENT No. 020-633

Contains 110 Cup and Shallow
Cup Type Expansion Plugs in
18 popular sizes.

MASTER ASSORTMENT No. 020-640

Contains 140 Standard and
Cup Type Expansion Plugs in
19 popular sizes.

These assortments are packed in metal boxes with high-strength plastic compartments. Features retail price codes on grease-resistant lid label and safety snap-lock handle. See page 7 for more details.

SUPER-SERVICE ASSORTMENT No. 020-800

Contains 200 Standard
and Cup Type Expansion
Plugs in 29 popular sizes.

SUPER-SERVICE ASSORTEMENT No. 020-801

Contains 170 Cup and
Shallow Cup Type Expan-
sion Plugs in 30 popular
sizes.



SUPER-SERVICE ASSORTMENT No. 020-840

Contains 180 Metric
Standard and Cup Type
Expansion Plugs in 28
popular sizes.

SUPER-SERVICE ASSORTMENT No. 020-841

Contains 150 Metric Cup
and Shallow Cup Type
Expansion Plugs in 25
popular sizes.

These assortments are packed in large size metal boxes with moulded plastic compartments. Features grease-resistant lid label, safety snap-lock handle and retail price codes. See page 9 for more details.

papco EXPANSION PLUGS MERCHANDISERS PRESENTOIRS DE BOUCHONS D'EXPANSION



34" w. x 11" h. x 11-5/8" d.

MERCHANDISER No. 022-098

INCH

Contains 1000 Standard,
Cup and Shallow Cup
Type Expansion Plugs. A
total of 54 popular inch
sizes. Packed in an all-
metal, 18 drawer cabinet.

MERCHANDISER No. 022-099

METRIC

Contains 600 Metric
Standard, Cup and Shal-
low Cup Type Expansion
Plugs. A complete cover-
age of all Metric Plugs.
Packed in an all-metal, 18
drawer cabinet.

For more details see page 12.

263
Series

papeco

'E-Z SEAL' EXPANSION PLUGS
BOUCHONS D'EXPANSION 'E-Z SEAL'



A new Expansion Plug designed to save Mechanic's time... will save hours of repair time in replacing core hole plugs, by simply tightening, even when Starter, Generator, Distributor, Manifold, Steering Linkage or Air Conditioner Components interfere.

Individually Carded
Handy instructions on back of each card.



- Slips in easily.
- Can be finger-tightened.
- Permanently set with open end wrench.
- No metal comes in contact with the coolant.
- Body of plug is specially compounded Neoprene, resistant to heat, antifreeze, and rust inhibitors.
- Expands as much as 1/8" to seal tightly against irregularities.

INCH
Order by Stock Number

Stock No.	Size	Metr. Equiv	Stock No.	Size	Metr. Equiv	Stock No.	Size	Metr. Equiv.
263-548	3/4	19mm	263-588	1-3/8	35mm	263-620	1-7/8	48mm
263-556	7/8	22mm	263-596	1-1/2	38mm	263-628	2"	51mm
263-564	1"	25mm	263-604	1-5/8	41mm	263-636	2-1/8	54mm
263-572	1-1/8	29mm	263-612	1-3/4	45mm	263-644	2-1/4	57mm
263-580	1-1/4	32mm						

METRIC

Install dry.
Do not use sealer.
Do not use where petroleum products contact rubber.
Do not overtighten.

Installe a sec.
L'employer pas d'adhésive.
L'employer pas ou des produits pétroleum d'evienront en contact avec le néoprène.
Ne pas trois serre.

Make sure washer and nut are loose.

Faire certain que la rondelle et l'ecrou ne sont pas serré.

Washer must be flush with side of wall before and after plug is installed.
La rondelle doit être égale avec le coté du mur avant d'être installé.

①



Plug must extend 1/4" beyond inside wall to allow a ridge to form.
Le tampons doit dépassé le mur intérieure d'au moins 1/4 de pouce pour permettre la formation d'un coussin.

Turn the nut clockwise 2 or 3 turns to form a ridge and properly set plug.
Pour bien placé ce tampon, serré l'ecrou de 2 ou 3 tours.

When properly installed plug will hold pressure to 50 P.S.I.
Quand bien posée un tampon soutiendra une pressions de 50 P.S.I.

②



papeco 'E-Z SEAL' EXPANSION PLUG
MERCHANDISER No. 022-123

Includes Rack, Header Sign, Inventory Control, Planogram and a 20 card stock of 'E-Z Seal Plugs' listed above.



ASSORTMENT No. 020-318

Contains 13 'E-Z Seal' Expansion Plugs - one of each size. Have every size on hand - repair leaking metal frost plugs in all locations - whether hard or easy to get to.



020-318

Contient 13 bouchons d'expansion 'E-Z Seal' - un de chaque format. Ayez tous les formats en main. Réparez les bouchons en métal protégeant contre la gelée à tous les endroits - difficiles ou faciles à rejoindre.

Use 'E-Z Seal' for Inch and Metric applications



267
Series

papco

**THICKNESS GAUGE LENGTHS
CALIBRES D'ÉPAISSEUR**



"Papco" Thickness Gauges are made from No. 1 Grade Swedish Steel, uniformly tempered and are of the highest accuracy obtainable. Each gauge is 12" long by 1/2" wide and has a hole punched in the end for hanging. The thickness in thousandths is permanently etched on the gauge. Standard package contains six lengths of a size, and each gauge is individually cellophane wrapped.

Order by Stock Number

Standard Package 6 Lengths

Stock No.	Thickness	Stock No.	Thickness	Stock No.	Thickness
267-015	.0015	267-110	.010	267-120	.020
267-020	.002	267-111	.011	267-122	.022
267-025	.0025	267-112	.012	267-124	.024
267-030	.003	267-113	.013	267-125	.025
267-040	.004	267-114	.014	267-126	.026
267-050	.005	267-115	.015	267-128	.028
267-060	.006	267-116	.016	267-130	.030
267-070	.007	267-117	.017	267-132	.032
267-080	.008	267-118	.018	267-140	.040
267-090	.009	267-119	.019		

papco

**PRECISION CALIPER
COMPAS PRECISION**

No. 022-031

"Papco" Precision Caliper is made of high impact styrene. Useful for all types of measurements in both inch and metric. Measures inside diameter, outside diameter, length and depth. Scales in 1/16" or 1mm increments.

Individually skin-packed.

Order by Stock No. 022-031



papco

**BOLT and NUT GAUGE
CALIBRE POUR BOULONS
et ECROUS**

No. 022-030

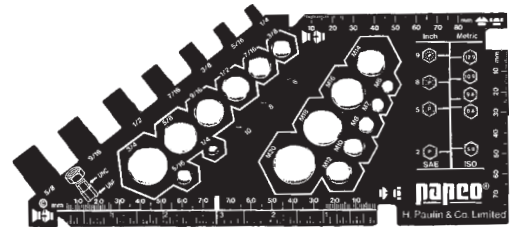

Heavy duty, plastic gauge for measuring UNC, UNF and Metric bolts, nuts, screws and studs. Individually packaged.

Order by Stock No. 022-030

papco

**ANTI-FREEZE TESTER
VERIFICATEUR D'ANTIGEL**

No. 263-999

- Tests all ETHYLENE GLYCOL solutions
- Allows visual inspection for rust and sediment
- Shows both degrees Fahrenheit and Celsius
- Individually blister-packed

Order by Stock No. 263-999

Winter Protection

Accurately and quickly indicates the freezing point of radiator solution.

Summer Protection

Indicates boiling point of coolant.





AIR CLEANER WING NUTS ECROUS A OREILLES POUR FILTRE A AIR



Universal type replacements for lost or stripped Air Cleaner Wing Nuts. Self-threaded series nylon nuts cut their own thread and may be used on either inch or metric hold-down shafts.

262
Series



262-314
262-316



262-324
262-325



262-326



700-106
700-108

Order by Stock Number

Stock No.	Size	Description	Qty.	Stock No.	Size	Description	Qty.
262-314	1/4 & 6mm	Self Threading Nylon	10	262-326	1/4-20	Chrysler Nylon	5
262-316	5/16 & 8mm	Self Threading Nylon	10	700-106	M6x1.0	Metric Wing Nut	25
262-324	1/4-20	Universal Domestic	10	700-108	M8x1.25	Metric Wing Nut	25
262-325	M6x1.0	Universal Imports	10				

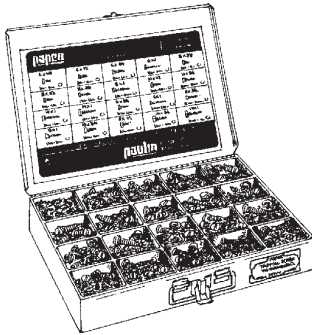

WING NUT AND HOOD PROP CLIP MASTER ASSORTMENT No. 020-608

Contains 90 pieces - 16 sizes of all listed Air Cleaner Wing Nuts as above - plus 5 sizes of Hood Prop Clips (see page 103).
Packed in a rigid all metal lidded box.



PCV VALVE GROMMETS RONDELLES ISOLANTES EN CAOUTCHOUC PCV

263
Series



PCV Valve Grommets are exposed to high temperatures and oil contamination that cause deterioration and eventual failure. Malfunction of these grommets can result in poor performance and reduced gas mileage. Grommets should be replaced at tune-up intervals.



Order by Stock Number

Stock No.	Description	Std. Pkg.	Stock No.	Description	Std. Pkg.
263-201	Universal 1/2 ID	5	263-211	Ford 1985-1986	5
263-202	Universal 5/8 ID	5	263-212	GM 1961-1990	5
263-203	GM 1979-1990	5	263-213	AMC (4/6) 1983-1988 (Rear)	5
263-204	Chrysler 1965-1990	5	263-214	AMC (4/6) 1983-1990 (Front)	5
263-205	GM (V-6) 3.8/4.1 1988-1986	5	263-215	GM 1976-1983	5
263-206	GM (V-6) 2.8L 1980-1986	5	263-216	Ford (4/6/8) 1987-1990	5
263-207	AMC 1965-1990	5	263-217	Ford (V-6) 3.0L 1986	3
263-208	GM (V-6) 3.8L 1975-1990	5	263-218	Pontiac (V-8) 1964-1975	3
263-209	Toyota 1970-1984	5	263-225	Elbow Ford 1968-1990	3
263-210	Toyota 1984-1990	5	263-226	Elbow GM (V-8) 1968-1990	3

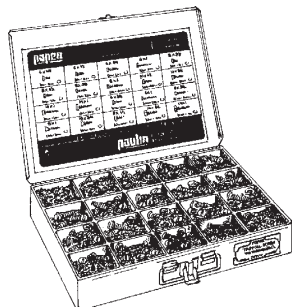

PCV VALVE GROMMET MASTER ASSORTMENT No. 020-683

Contains 42 Grommets - 20 sizes as listed above.
Packed in a metal divided box with hinged lid.



Papco® THROTTLE ROD CLIPS and RETAINERS ATTACHES DE TIGE A SOUPAPE

"Papco" Throttle Rod Clips are made of hardened spring steel in right and left hand styles. The retainer springs, or hairpin cotters, are measured by the diameter of the centre eye.

262
Series



TYPE 1



TYPE 2



TYPE 3



TYPE 4



TYPE 5

Order by Stock Number

Stock No.	Size	Type	Std. Pkg.	Stock No.	R. Dia.	Type	Std. Pkg.	Stock No.	Size	Type	Std. Pkg.
262-008*	5/32R	1	25	262-056*	1/8	2	25	262-078*	5/32	3	100
262-009*	5/32L	1	25	262-060*	1/4	2	25	262-080	3/16	3	100
262-010*	3/16R	1	25	262-062*	1/8(GM)	4	25	262-084	1/4	3	100
262-011*	3/16L	1	25	262-064*	1/4(GM)	4	25	262-086	5/16	3	100
262-014*	1/4R	1	25	262-073*	1/16	3	100	262-088	3/8	3	100
262-015*	1/4L	1	25	262-075*	5/64	3	100	268-516	5/16	5	18
262-054*	3/32	2	25	262-076*	1/8	3	100				

*Retainers

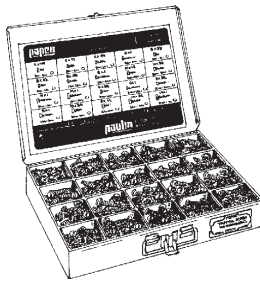

CARBURETOR CLIP MASTER ASSORTMENT NO. 020-609

Contains 293 pieces, 18 sizes for complete coverage. Packed in an all metal, lidded box. See page 6 for contents listing.



THROTTLE ROD CLIP GARAGE ASSORTMENT NO. 020-022

Contains 104 pieces, *15 sizes as listed above, includes both clips and hairpin cotters. Packed in a transparent plastic box with individual sections. Useful for carburetor repair jobs.

262
Series



THROTTLE BALL JOINTS JOINTS A ROTULE

Used to adjust throttle linkages and control rods on automobiles, trucks, snowmobiles, marine and off the road equipment. Made of heat treated carbon steel and bright plated for corrosion resistance.

Type G
(Solid)

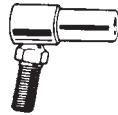

High strength design with good wear resistance for heavy duty service. Oil and gas resistant rubber shield protects against abrasive dirt.

Type A
(Spring
Loaded)

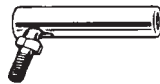

Conforms to S.A.E. Standards with case hardened seats and ball studs for extra wear resistance. Spring loaded for zero end-play.

Type P
(Quick
Disconnect)



Lightweight economical quick disconnect design. Ball studs can be removed from spring steel retaining clip for making length adjustments.

Convenient skin-packed card contains one Ball Joint.

Individually Carded

Order by Card Number

Card No.	Type	Size	Card No.	Type	Size
262-203	G	10-32	262-208	G	1/2-20
262-204	G	1/4-28	262-210	A	10-32
262-205	G	5/16-24	262-211*	A	1/4-28
262-206*	G	3/8-24	262-212*	A	5/16-24
262-207	G	7/16-20	262-218	P	1/4-28

* Most Popular



268
Series

papeo SNAP RINGS CIRCLIPS

HIGH CARBON STEEL

RETAINER RINGS

HEAT TREATED FOR RESILIENCY

Used as retainers on automotive, appliance and heavy equipment applications. Packaged in uniformly priced transparent packs. Number of rings per pack is shown below.

Order by Stock Number

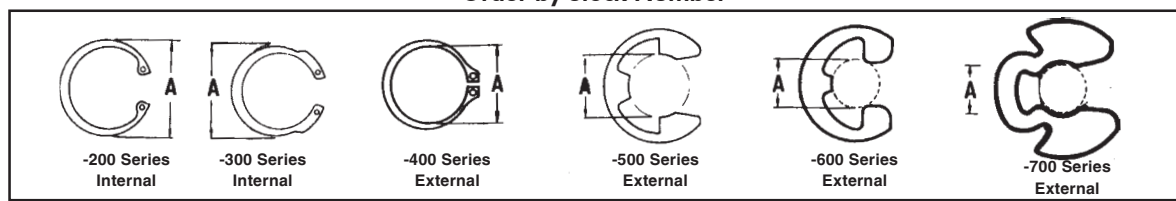

INTERNAL TYPES (HOUSING)					EXTERNAL TYPES (SHAFT)				
Stock No.	Industry No.	Housing Dia.	Free Dia. "A"	Pieces Per Pack	Stock No.	Industry No.	Shaft Dia.	Free Dia. "A"	Pieces Per Pack
268-222	5000-50	1/2"	.548"	10	268-436	5100-131	1-5/16"	1.214"	4
268-224	5000-62	5/8	.694	10	268-438	5100-137	1-3/8	1.272	4
268-226	5000-75	3/4	.831	8	268-440	5100-150	1-1/2	1.387	3
268-227	5000-81	13/16	.901	8	268-442	5100-175	1-3/4	1.618	2
268-228	5000-87	7/8	.971	6	268-444	5100-200	2"	1.850	2
268-230	5000-100	1"	1.111	6	268-505	5133-12	1/8	.094	18
268-231	5000-106	1-1/16	1.180	5	268-506	5133-15	5/32	.114	18
268-232	5000-112	1-1/8	1.249	5	268-510	X5133-18	3/16	.122	18
268-234	5000-125	1-1/4	1.388	4	268-511	5133-18	3/16	.145	18
268-237	5000-137	1-3/8	1.526	4	268-514	5133-25	1/4	.207	18
268-238	5000-150	1-1/2	1.660	3	268-516	5133-31	5/16	.243	18
268-242	5000-175	1-3/4	1.942	2	268-518	5133-37	3/8	.300	14
268-246	5000-200	2"	2.210	2	268-520	5133-43	7/16	.337	14
268-329	5008-093	15/16	1.015	6	268-522	5133-50	1/2	.392	12
268-330	5008-100	1"	1.081	6	268-606	5144-15	5/32	.113	18
268-332	5008-112	1-1/8	1.217	5	268-610	5144-18	3/16	.143	18
EXTERNAL TYPES (SHAFT)					268-614	5144-25	1/4	.204	18
268-414	5100-25	1/4	.225	15	268-616	5144-31	5/16	.242	18
268-418	5100-37	3/8	.338	14	268-618	5144-37	3/8	.292	14
268-422	5100-50	1/2	.461	10	268-620	5144-56	9/16	.430	9
268-424	5100-62	5/8	.579	10	268-714	T5304-25	1/4	.187	7
268-426	5100-75	3/4	.693	8	268-716	T5304-31	5/16	.250	6
268-428	5100-87	7/8	.810	7	268-718	T5304-37	3/8	.312	6
268-430	5100-100	1"	.925	6	268-722	T5304-50	1/2	.406	5
268-432	5100-112	1-1/8	1.041	5	268-724	T5304-62	5/8	.500	4
268-434	5100-125	1-1/4	1.156	4					

SNAP RING GARAGE ASSORTMENT No. 020-040



Contains 60 Snap Rings, 9 sizes of 268-500 Series, for 1/8 to 1/2" dia. shafts.

SNAP RING MASTER ASSORTMENT No. 020-627

Contains 401 Snap Rings, 36 sizes. Priced label in lid has actual size ring outlines for easy identification. Metal box has moulded compartments. Has a complete stock of all ring sizes and types listed above.

Size: 9-3/4" w. x 13-3/4" l. x 2" d.

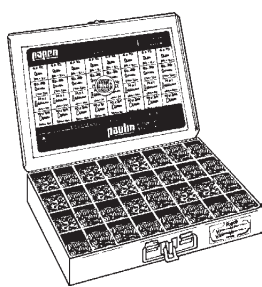

papeo SUPER SERVICE ASSORTMENT No. 020-817

Contains 705 Snap Rings - 50 sizes.
Large size, rigid metal box with high-strength plastic compartments.
For more details see page 9. Large size: 12" w. x 18" l. x 3" d.



268
Series

papeo

SNAP RINGS CIRCLIPS
AGRAFES DE BUTÉE

Packaged in uniformly priced transparent packs.

Order by Stock Number

Illustrations Actual Size

* Example of Stock Number: 268-246

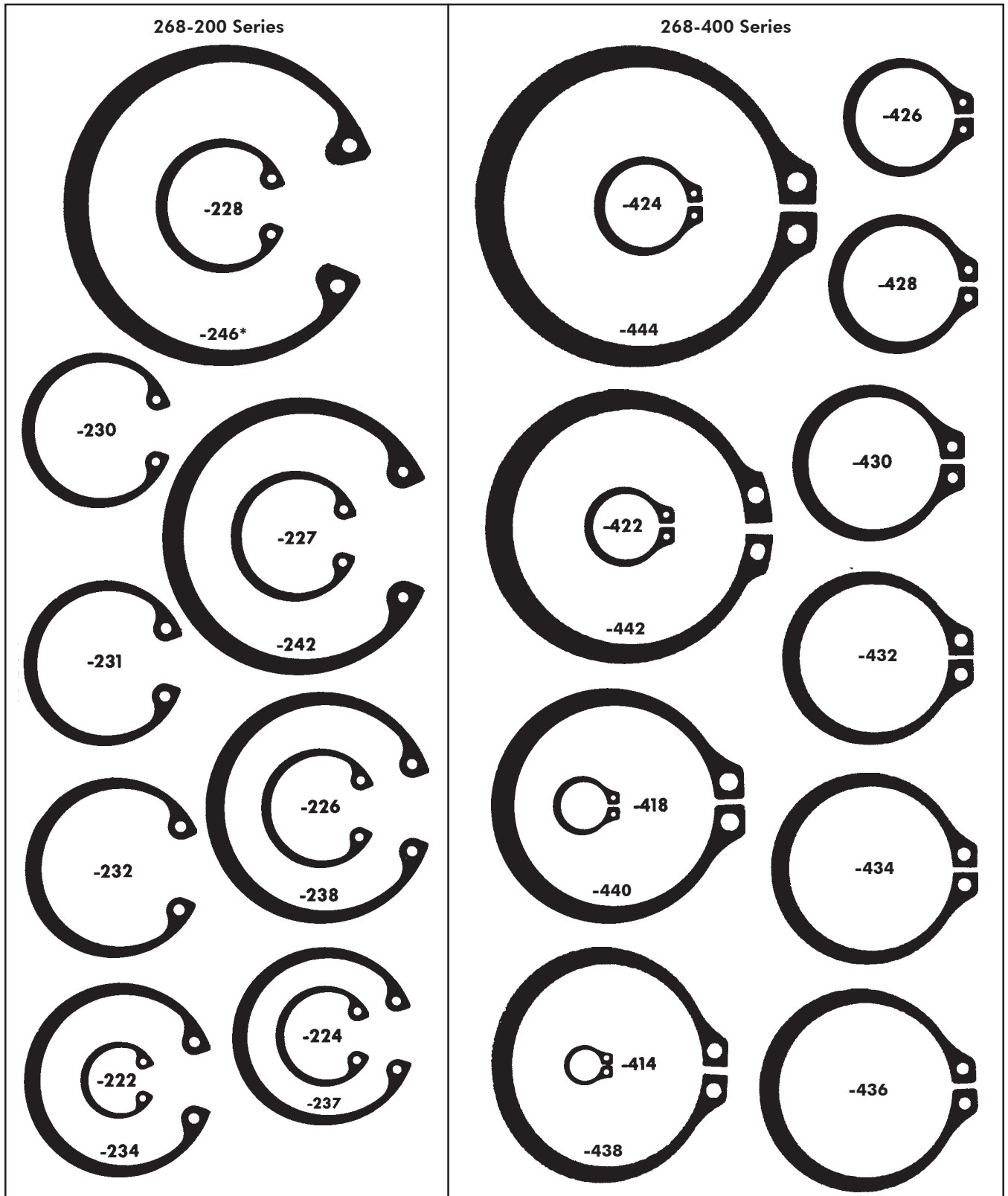

For Other sizes of Snap Rings - see next page.



268
Series

papeco

SNAP RINGS CIRCLIPS

* Example of Stock
Number: 268-522

Order by Stock Number

Illustrations Actual Size

	268-500 Series									
	268-600 Series									
	268-700 Series									

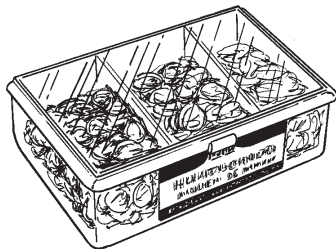

SNAP RING GARAGE ASSORTMENT No. 020-041

Contains 50 External Snap Rings, 6 sizes of 268-600 Series for 5/32" through 9/16" dia. shafts.

GARAGE ASSORTMENT No. 020-042

Contains 50 Internal Snap Rings, 10 sizes of 268-200 Series for 1/2" through 2" housing diameters.

262
Series

papeco

SNAP RING PLIERS PINCES A CIRCLIP

Order by Stock Number

Individually Carded

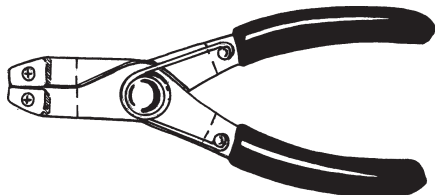

No. 262-980 EXTERNAL with TIPS (Black)
No. 262-981 INTERNAL with TIPS (Red)
No. 262-982 SNAP RINGS PLIERS SET
 Economical tools for medium duty.
 Non-slip cushion coated grips on stamped steel handles.
 Complete with four sets of tips.

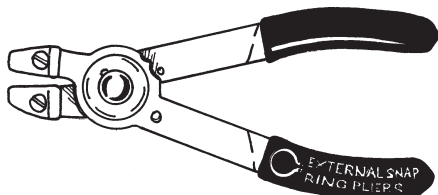

No. 262-976 EXTERNAL with TIPS (Black)
No. 262-977 INTERNAL with TIPS (Red)
 Professional quality tools have no exposed springs to pop out or snag other tools. Non-slip cushion-coated handles make pliers easy to grip and use.
 Complete with four sets of tips.



No. 262-983 PRECISION TIPS SET

- | | |
|----------------------|-----------------|
| 1 pr. .045" Straight | 1 pr. .035" 45° |
| 1 pr. .060" Straight | 1 pr. .045" 90° |



263
Series



papco® 'DUO-DRAIN' OIL PLUG
BOUCHON D'HUILE DUO-DRAIN®

BRIGHT PLATED

All metal, two-part plug for repairing 1/2"-20 crankcase applications on GM, Ford, Chrysler and AMC. STANDARD or Self-tapping DOUBLE OVERSIZE outer plug installs permanently. Only the pipe threaded centre plug is removed to drain oil. Convenient skin-packed card contains one (1) Duo-Drain Oil Plug complete with gasket.

1/2 Standard No. 263-798 1/2-20 D.O. No. 263-799



papco® **CARDED**
DRAIN PLUGS with GASKET
BOUCHON DE VIDANGE avec JOINT

Convenient skin-packed card contains one 'Papco' Drain Plug complete with nylon gasket. Order by Card Number.

Card No.	Size & Thread	Gasket No.	Card No.	Size & Thread	Gasket No.
263-780	12mm x 1.75 Std.	263-815	263-789	20mm x 1.5 Std.	263-824
263-782	12mm x 1.25 Std.	263-815	263-790	1/2-20 Std.	263-816
263-783	14mm x 1.5 Std.	263-817	263-791	1/2-20 O.S. Self-Tap	263-816
263-785	16mm x 1.33 Std.	263-820	263-792	1/2-20 D.O. Self-Tap	263-817
263-787	12mm x 1.75 Std.	263-824	263-793	1/2-20 T.O. Self-Tap	263-820



Card No.
263-791

'Papco' CARDED OIL DRAIN PLUG MERCHANDISER No. 022-130

Contains all 15 sizes of carded 'Papco' Oil Drain Plugs with gaskets, plus 4 sizes of 'Papco' E-Z Seal Oil Drain Plugs - 26 plugs in total. Includes header sign and merchandising rack suitable for wall, pegboard, counter or gondola display. See page 130 for carded Magnetic Drain Plugs.

papco® **DRAIN PLUG GASKETS**
JOINTS POUR BOUCHON DE VIDANGE

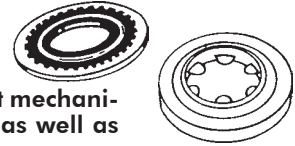

'Papco' Selon® Drain Plug Gaskets are made of special nylon with excellent mechanical properties and long life. Also available are copper and fibre gaskets as well as aluminum and rubber/metal gaskets.

Order by Stock Number

Standard Package 25 Pieces

Part No.	Description	Part No.	Description	Part No.	Description
263-815	Nylon 31/64 x 3/4	263-856	Copper 19/32 x 13/16	263-805	Fibre 13/16 x 1 x 3/32
263-816	Nylon 9/16 x 13/16	263-857	Copper 5/8 x 1"	263-807	Fibre .920 x 1-1/8 x 3/32
263-817	Nylon 5/8 x 15/16	263-860	Copper 3/4 x 1-1/16	263-808	Fibre 12mm x .748 x 3/32
263-818	Nylon 12mm x 25mm	263-800	Fibre 1/2 x 3/4 x 3/32	263-809	Fibre 16mm x 1.062 x 3/32
263-820	Nylon 11/16 x 1"	263-801	Fibre 9/16 x 13/16 x 3/32	263-810	Fibre 18mm x 1.062 x 3/32
263-824	Nylon 13/16 x 1-1/16	263-802	Fibre 5/8 x 7/8 x 3/32	263-870	Alum. 14mm x 20mm
263-828	Nylon 31/64 x 1-1/4	263-803	Fibre 11/16 x 7/8 x 3/32	263-873	Alum. 18mm x 26mm
263-855	Copper 31/64 x 3/4	263-804	Fibre 3/4 x 1-1/16 x 3/32	263-875	Rubber/Met. 12mm x 25mm

GARAGE ASSORTMENT No. 020-054

Contains 60 Nylon Gaskets in six popular sizes for Inch and Metric Drain Plugs.

GARAGE ASSORTMENT No. 020-038

Contains 9 Inch and Metric Drain Plugs with gaskets. (4) 1/2-20 Std. (3) 12mm x 1.75, (2) 14mm x 1.5.



GARAGE ASSORTMENT No. 020-032

Contains 7 Self-Tapping Oversize Drain Plugs with gaskets. (4) 1/2-20 O.S., (2) 1/2-20 D.O., (1) 1/2-20 T.O.

MASTER DRAIN PLUG ASSORTMENT No. 020-635

Contains 40 Inch and Metric Plugs; 85 Gaskets - and includes Magnetic and 1/2-20 oversize plugs. 16 Sizes of Plugs, 10 Sizes of Gaskets. Complete coverage for most vehicles.

MASTER DRAIN PLUG GASKET ASSORTMENT No. 020-607

Contains 210 pieces - 20 of the most popular Sizes of Nylon, Copper, Fibre, Aluminum and Rubber/Metal Drain Plug Gaskets.



020-635

263
Series



DRAIN and FILLER PLUGS BOUCHONS DE VIDANGE



'Papco' Drain Plugs are manufactured in seven types and are available in Inch and Metric sizes. Type 2 oversized plugs are tapered, hardened and cut their own thread where the original has been stripped. To use an oversized plug, hold in a straight position and tighten with a socket wrench. Plug is then removed to clear metal particles and then reinstalled. Each Drain Plug is supplied with a nylon gasket.

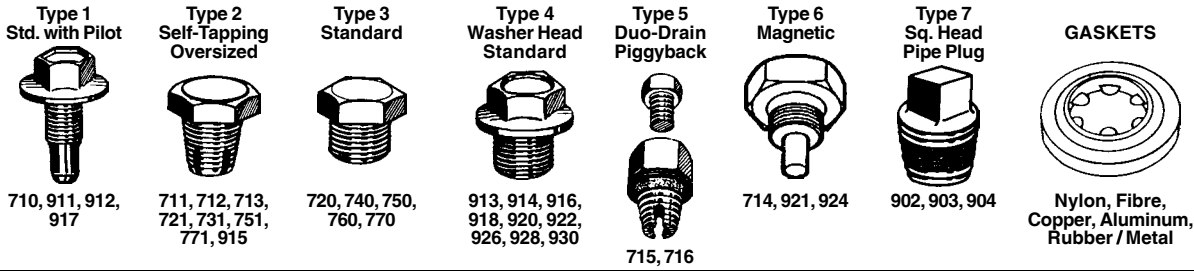

DRAIN PLUGS				GASKETS				
STOCK NO.	SIZE & THREAD	TYPE	STD. PKG	NYLON	FIBRE	COPPER	ALUMINUM	RUBB./MET.
263-710	1/2-20 Std.	1	12	263-816	263-800	263-856		263-875
263-711	1/2-20 O.S. Self-Tap	2	12	263-816	263-801	263-856		263-875
263-712	1/2-20 D.O. Self-Tap	2	12	263-817	263-801	263-857	263-870	
263-713	1/2-20 T.O. Self-Tap	2	12	263-820	263-802	263-860		
263-714	1/2-20 Magnetic	6	12	263-816	263-800	263-856		263-875
263-715	1/2-20 D.O. Duo-Drain	5	5	263-817	263-801	263-857	263-870	
263-716	1/2-20 Std. Duo-Drain	5	5	263-816	263-800	263-856		263-875
263-718	1/2-20 Pilot Pt. w/ Molded Gasket	6	5	N/R	N/R	N/R	N/R	N/R
263-720	5/8-18 Std.	3	12	263-820		263-860		
263-721	5/8-18 O.S. Self-Tap	2	12	263-820	263-803	263-860		
263-731	1 1/16-16 O.S. Self-Tap	2	12	263-824	263-804			
263-750	3/4-16 Std.	3	12	260-824	263-804			
263-751	3/4-16 O.S. Self-Tap	2	12	263-824	263-805			
263-760	7/8-16 Std.	3	12	263-828				
263-770	7/8-18 Std.	3	12	263-828				
263-771	7/8-18 O.S. Self-Tap	2	12	263-828	263-807			
263-778	1/2-20 Std.	1	5	263-816	263-800	263-856	263-869	263-875
263-795	1/2-20 Magnetic	8	5	263-816	263-800	263-856	263-869	263-875
263-908	M12 x 1.75 Pilot Pt. w/ Moulded Gasket	6	5	N/R	N/R	N/R	N/R	N/R
263-911	M12 x 1.75 Std. with Pilot	1	12	263-815	263-808	263-855		263-875
263-912	M12 x 1.25 Std. with Pilot	1	12	263-815	263-808	263-855		263-875
263-913*	M12 x 1.25 Std.	4	12	263-815	263-808	263-855		263-875
263-914	M14 x 1.5 Std.	4	12	263-817	263-801	263-856	263-870	
263-915	M14 x 1.5 O.S. Self-Tap	2	12	263-820		263-860		
263-916*	M16 x 1.33	4	12	263-820		263-860		
263-917	M14 x 1.5 Std. with Pilot	1	12	263-817	263-801	263-856	263-870	
263-918	M18 x 1.5 Std.	4	12	263-824		263-860	263-873	
263-919	M12 x 1.75 Pilot Pt. w/ Inset Gasket	5	5	N/R	N/R	N/R	N/R	N/R
263-920	M20 x 1.5 Std.	4	12	263-824				
263-921	M12 x 1.75 Magnetic	6	5	263-815	263-808	263-855		263-875
263-922	M14 x 1.25 Std.	4	12	263-817	263-801	263-856	263-870	
263-923	M14 x 1.5 Pilot Pt. w/ Molded Gasket	6	5	N/R	N/R	N/R	N/R	N/R
263-924	M14 x 1.5 Magnetic	6	12	263-817	263-801	263-856	263-870	
263-925	M14 x 1.5 Pilot Pt. w/ Inset Gasket	6	5	N/R	N/R	N/R	N/R	N/R
263-926	M16 x 1.33 w/ Fibre Gask.	4	5	263-820	263-809			
263-928	M18 x 1.5 w/ Std. Fibre Gs.	4	5	263-824	263-810		263-873	
263-929	M12 x 1.75 Magnetic w/ PP & Inset Gasket	8	5	N/R	N/R	N/R	N/R	N/R
263-930	M20 x 1.5 w/ Std. Fibre Gs.	4	5	263-824	236-807			
263-931	M12 x 1.5 Std.	3	5	263-815	263-808	263-855	263-869	263-875
263-932	M12 x 1.75 Pilot Pt. w/ Inset Gasket	5	5	N/R	N/R	N/R	N/R	N/R
263-933	M12 x 1.25 Std.	4	5	263-815	263-808	263-855	263-869	263-875
263-934	M14 x 1.5 Std.	4	5	263-817	263-801	263-856	263-870	263-876
263-937	M14 x 1.5 Pilot Pt.	1	5	263-817	263-801	263-856	263-870	263-876
263-940	M22 x 1.5 Std.	4	5	263-828				
263-942	M12 x 1.25 Pilot Pt.	1	5	263-815	263-808	263-855	263-869	263-875
263-944	M12 x 1.75 Pilot Pt.	1	5	263-815	263-808	263-855	263-870	263-875
263-945	M12 x 1.75 S.O. Self-Tap	2	5	263-817	263-801	263-855	263-870	263-876
263-947	M14 x 1.5 Pilot Pt.	1	5	263-817	263-801	263-856	263-870	263-876
263-950	M14 x 1.5 Std. w/ Inset Gasket	5	5	N/R	N/R	N/R	N/R	N/R
263-954	M14 x 1.5 Std.	4	5	263-817	263-801	263-856	263-870	263-876
263-958	M14 x 1.5 Pilot Pt. w/ Inset Gasket	5	5	N/R	N/R	N/R	N/R	N/R
263-960	M 14 x 1.5 Std.	5	5				263-870	
263-974	M14 x 1.5 Std.	4	5	263-817	263-801	263-856	263-870	263-876
263-984	M14 x 1.5 Std.	4	5	263-817	263-801	263-856	263-870	263-876
263-990	UNIV. 1/2-3/4, 12-18mm	-	3	N/R	N/R	N/R	N/R	N/R
260-902	1/4" Sq. Pipe Plug	7	12					
260-903	3/8" Sq. Pipe Plug	7	12					
260-904	1/2" Sq. Pipe Plug	7	12					
				ALL GASKETS STANDARD PACKAGE 25 PIECES				

* Nominal Diameter

CARDED MAGNETIC DRAIN PLUG with GASKET

'Papco' Magnetic Drain Plugs reduce wear and protect engines by attracting harmful metal particles circulating in the crankcase oil. Powerful, long-lasting ALNICO magnet. Install in place of ordinary plugs. Individually skin-packed with gasket.

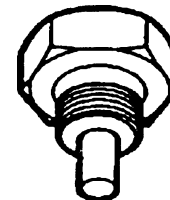

Card No.	Size & Thread	Gasket No.	Card No.	Size & Thread	Gasket No.
263-781	12mm x 1.75 Magnetic	263-815	263-794	1/2-20 Std. Magnetic	263-816
263-784	14mm x 1.5 Magnetic	263-817			

For more up to date applications of 'Papco' Drain Plugs, please see current Oil Drain Plugs catalogue/application guide.





263
Series



DRAIN PLUG APPLICATION CHART APPLICATION DE BOUCHON DE VIDANGE

Year	Cyl.	Application	Plug Part No.	Carded Part No.	E-Z Seal Part No.	Year	Cyl.	Application	Plug Part No.	Carded Part No.	E-Z Seal Part No.
ACURA						GM/ GMC					
1986-up	All		263-914	263-783	263-322	1982-up	(8) 260, 262, 265, 267, 4.4 Chev, 302, 305, 307, 327, 330, 340, 348, 350 All, 366, 368, 396, 400, 402, 403, 409, 425, 427, 429, 430, 454, 455, 472, 500		*263-710	263-790	+263-320
AMC						HONDA					
1983-up	(4) AMC/ Renault Engine		263-922	—	—	1987-91	All Inc. 83-86 Prelude		263-914	263-783	263-322
1980-83	(4) 2.5(151) GM Engine		263-911	263-780	263-290	1973-86	All Exc. Prelude		263-920	263-789	—
1976-80	(4) 121 CID		263-914	263-783	263-322	HYUNDAI					
1964-85	(6) (8) All In line 6 and V8		*263-710	263-790	+263-320	1986-91	All		263-914	263-783	263-322
AUDI						ISUZU					
1974-91	All		263-914	263-783	263-322	1981-89			263-914	263-783	263-322
CHRYSLER						1987-90	(4) All		263-922	—	—
1987-up	(4) 2.2(135), 2.5(153)		263-913	263-782	263-290	LEXUS					
1981-87	(4) 2.2(135), 2.5(153), 1.7, 2.6		263-914	263-783	263-322	1990-91	All		263-922	—	—
1990-up	(6) 3.3(201.5)		263-913	263-782	263-290	MAZDA					
1960-82	(6) 170, 196, 225		*263-710	263-790	+263-320	1972-91	All		263-914	263-783	263-322
1987-90	(6) 3.0(183)		263-750	—	—	MITSUBISHI					
1988-91	(6) 5.9 Diesel		263-918	263-787	—	1983-90	All		263-914	263-783	263-322
1962-87	(8) All		*263-710	263-790	+263-320	NISSAN/ DATSUN					
1987-91	(8) 5.2(318)		263-913	263-782	263-290	1982-91	All 12mm plugs		263-913	263-782	263-290
FORD						1962-91	All 16.4mm plugs		263-916	263-785	263-400
1970-up	(4) All		263-914	263-783	263-322	PEUGOT					
1973-up	(6) 2.8(171), 2.9(177), 3.0(183) exc. 86-89 3.8(230) exc. 82-88		263-914	263-783	263-322	1980-90	All 16mm plugs		263-916	263-785	263-400
1982-89	(6) 3.0(183), 3.8(230)		*263-710	263-790	+263-320	1980-86	All 20mm plugs		263-920	263-789	—
1965-88	(6) 144, 170, 200, 240, 250, 300, 3.3, 4.1		*263-710	263-790	+263-320	RENAULT					
1980-up	(6) 4.9(300)		*263-710	263-790	+263-320	1983-87	AMC/ Renault Engine		263-914	263-783	263-322
1983-91	(8) 4.6, 5.8(351W), 6.1(370), 6.9(420) Diesel, 7.0(429), 7.3(455), 7.5(460)		263-914	263-783	263-322	1980-87	Alliance, Encore, Fuego, LeCar		263-916	263-785	263-400
1957-91	(8) All Other 8 cyl.		*263-710	263-790	+263-320	SAAB					
GEO						1978-90	All		263-914	263-783	263-322
1989-91	Metro, Tracker, Storm		263-914	263-783	263-322	SUBARU					
1989-91	Prizm		263-922	—	—	1974-90	All		263-920	263-789	—
GM/ GMC						SUZUKI					
1982-up	(4) 1.8(112), 1.9(119), 2.0(121)		263-914*	263-783	263-322	1986-91	All		263-914	263-783	263-322
1987-up	(4) 1.8(112), 2.0(121), 2.2(134), 2.3(138), 2.5(151) 78-94 Buick, Chev, 78-88 Olds, Pont.		263-911*	263-780	263-290	TOYOTA					
1987-up	(4) 2.5(151)		*263-710*	263-790	+263-320	1980-91	All 12mm plugs		263-913	263-782	263-290
1982-88	(4) 1.4, 1.6, 1.8(112), 2.0(121)		263-911*	263-780	263-290	1975-85	All 18mm plugs		263-918	263-787	—
1982-up	(6) 2.8(173), 3.0(181), 3.1(189) Buick, 3.4(207), 4.3T, V(260) Diesel		*263-710	263-790	+263-320	VOLKSWAGEN					
1982-up	(6) 3.3(204) Buick, 3.8(231)		*263-710*	263-790	+263-320	1974-83	1500cc, 1600cc		263-914	263-783	263-322
1980-88	(6) 2.8(173), 3.0(181), 3.8 (196, 200, 229), 3.8(231), 4.1(252), 4.32 Chev V6		*263-710*	263-790	+263-320	VOLVO					
						1971-89	(4) All Exc. Diesel		263-750	—	—
						1980-89	(4) Diesel		263-914	263-783	263-322
						1971-89	(6) All		263-916	263-785	—

For more up-to-date applications of 'Papco' Drain Plugs, please see current Oil Drain Plugs catalogue/application guide.



PAPCO OIL PAN BOLTS

Replacement bolts for lost or broken oil or transmission pans. Type 4 oversized bolts for cutting new threads in stripped transmission or oil pan mounting holes. Special chip clearing point.

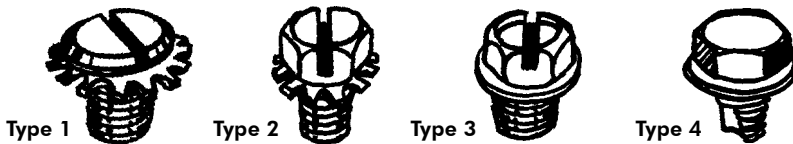

Standard Package 25 Pieces

Stock No.	Size	Type
263-001	1/4-20 x 7/16	1
263-002	1/4-20 x 7/16	2
263-003	5/16-18 x 9/16	2
263-004	5/16-18 x 1/2	3
263-005	1/4-20 x 1/2	3
263-006	5/16-18 x 5/8	3
263-010	M6x1.0 x 14mm	3
263-011	M8x1.25 x 14mm	3
263-020	1/4-20 x 1/2	4
263-021	5/16-18 x 5/8	4
263-022	M6x1.0 x 14mm	4
263-023	M8x1.25 x 14mm	4

252
Series

Papco BRASS BRAKE BLOCK BOLTS BOULONS POUR SABOT DE FREIN



252-221
252-354

'Papco' Brass Brake Lining Fasteners, No. 252-221 and No. 252-354 are used to replace rivets on many truck and trailer applications. The 3/8" Diameter Brass Bolts are used on Brake Blocks. In each case the screw is Brass to avoid scoring and the hexagon nuts and lock washers are steel.

252-489
252-491
252-493



Order by Stock Number

Standard Package Contains 100 assemblies.

Stock No.	Size	Description
252-221	10-32 x 1"	Spec. Flat Brass Screw, Hex. Steel Nut, Lock Washer
252-354	1/4-28 x 1"	Spec. Flat Brass Screw, Hex. Steel Nut, Lock Washer
252-489	3/8-16 x 1"	Flat Head Brass Screw, Hexagon Steel Nut
252-491	3/8-16 x 1-1/4"	Flat Head Brass Screw, Hexagon Steel Nut
252-493	3/8-16 x 1-1/2"	Flat Head Brass Screw, Hexagon Steel Nut

260
Series

Papco SQUARE HEAD PIPE PLUGS BOUCHONS DE TUYAU TETE CARRE



With LOCTITE® Vibra-Seal®

These forged steel pipe plugs are used as drain and filler plugs on all cars, trucks, tractors and stationary engines. Made with Dryseal American National Pipe Threads. For improved reliability 'Papco' Pipe Plugs feature LOCTITE® Vibra-Seal® pre-applied thread sealant.



Order by Stock Number

Standard Package 12 plugs

Iron Pipe Size	1/8-27 Thread	1/4-18 Thread	3/8-18 Thread	1/2-14 Thread	3/4-14 Thread
Stock No.	260-901	260-902	260-903	260-904	260-906
Approximate Diameter Small End	3/8"	1/2"	5/8"	7/8"	1"

SQUARE HEAD PIPE PLUG GARAGE ASSORTMENT

No. 020-043

Contains 20 Square Head Pipe Plugs in 1/8, 1/4 and 3/8 iron pipe sizes. Packed in a clear, plastic box.



SOCKET PIPE PLUG GARAGE ASSORTMENT

No. 020-087

Contains 20 Socket Pipe Plugs in 1/8, 1/4 and 3/8 iron pipe sizes. Packed in a sturdy, transparent, plastic box.

SQUARE HEAD PIPE PLUG UTILITY ASSORTMENT

No. 020-332

Contains 42 Square Head Pipe Plugs in 1/8, 1/4, 3/8 and 1/2 pipe sizes. Packed in a sturdy fibreboard container with moulded compartments.

Papco SOCKET PIPE PLUGS BOUCHONS DE TUYAU CREUX



260
Series

Hexagon Socket Steel Plugs with LOCTITE® Vibra-Seal® pre-applied thread sealant.



Order by Stock Number

Standard Package 12 plugs

Iron Pipe Size	1/8-27 Thread	1/4-18 Thread	3/8-18 Thread	1/2-14 Thread
Stock No.	260-921	260-922	260-923	260-924



300
Series

papeo® SLOTTED SPRING PINS GOUPILLES RESSORT FENDUE

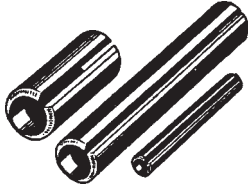

These high-carbon spring steel pins replace dowel pins, straight pins, taper and groove pins. They can be driven into an ordinary drilled hole and will hold position due to their spring action - no peening or rivetting. Re-usable - easy to insert and remove. Shock resistant, vibration proof - stronger than solid pins. Spring pins are oversize, they contract when inserted in the nominal size drill hole.

Order by Stock Number

Standard Package Contains 50 Pins

Stock No.	Nom. Dia. x Length	Stock No.	Nom. Dia. x Length	Stock No.	Nom. Dia. x Length	Stock No.	Nom. Dia. x Length
300-038	1/16 x 3/16	300-091	3/32 x 1	300-189	3/16 x 1/2	300-313	1/4 x 1-1/2
300-040	5/16	300-093	1-1/4	300-190	5/8	300-315	1-3/4
300-043	1/2	300-095	1-1/2	300-191	3/4	300-316	2
300-044	5/8	300-134	1/8 x 3/8	300-193	1	300-317	2-1/4
300-045	3/4	300-137	1/2	300-195	1-1/4	300-318	2-1/2
300-046	7/8	300-138	5/8	300-197	1-1/2	300-442	5/16 x 3/4
300-047	1	300-139	3/4	300-199	1-3/4	300-443	7/8
300-059	5/64 x 1/4	300-140	7/8	300-200	2	300-444	1
300-063	1/2	300-141	1	300-201	2-1/4	300-448	1-1/2
300-064	9/16	300-143	1-1/4	300-247	7/32 x 5/8	300-450	1-3/4
300-065	3/4	300-145	1-1/2	300-252	1-1/4	300-451	2
300-067	1	300-147	1-3/4	300-253	1-3/8	300-453	2-1/2
300-069	1-1/4	300-148	2	300-254	1-1/2	300-487	3/8 x 3/4
300-071	1-1/2	300-163	5/32 x 1/2	300-256	1-3/4	300-489	1
300-084	3/32 x 5/16	300-164	5/8	300-306	1/4 x 5/8	300-493	1-1/2
300-087	1/2	300-165	3/4	300-307	3/4	300-496	2
300-088	5/8	300-167	1	300-308	7/8	300-498	2-1/2
300-089	3/4	300-169	1-1/4	300-309	1	300-500	3
300-090	7/8	300-171	1-1/2	300-311	1-1/4		



papeo SPRING PIN ASSORTMENTS

Automotive uses include Drive Shaft Coupling Pins, gear shift lever pins, pump shaft pins, window regulator pins, door handle retaining pins, automatic transmission pins, etc. Also used in Agricultural Machinery and Farm equipment.

UTILITY ASSORTMENT No. 020-319

Contains 116 pins, 12 sizes. Packed in a sturdy fibre board box with illustrated lid label showing retail price codes.

SPRING PIN MASTER ASSORTMENT No. 020-642

Contains 275 Pins, 20 popular sizes in a metal box with moulded plastic compartments, hinged lid, carrying handle and safety snap lock. Useful for construction and farm equipment dealers.

Size: 9-3/4" w. x 13-3/4" l. x 2" d.

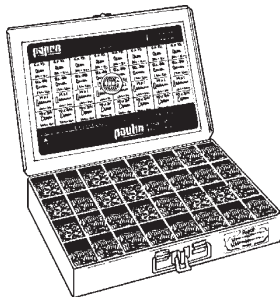

papeo SUPER SERVICE ASSORTMENT No. 020-819

Contains 770 Spring Pins - 32 sizes.
Large size, rigid metal box with high-strength plastic compartments.

For more details see page 9.

Large size: 12" w. x 18" l. x 3" d.

302
Series

papco WOODRUFF KEYS
CLAVETTES 'WOODRUFF'



'Papco' WOODRUFF KEYS are made from S.A.E. 1035 Carbon Steel. They are used on armature shafts of starters and generators, etc.

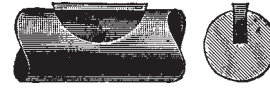

Order by Stock Number

Standard Package 25 Keys

Stock No.	Size Width x Dia.	Stock No.	Size Width x Dia.	Stock No.	Size Width x Dia.	Stock No.	Size Width x Dia.
302-010	1/16 x 1/2	302-091	1/4 x 3/4	302-170	7/32 x 1-1/8	302-236	3/8 x 1-3/8
302-020*	3/32 x 1/2	302-100*	5/32 x 7/8	302-180*	1/4 x 1-1/8	302-240	1/4 x 1-1/2
302-030*	1/8 x 1/2	302-110*	3/16 x 7/8	302-183	5/16 x 1-1/8	302-250	5/16 x 1-1/2
302-040*	3/32 x 5/8	302-120	7/32 x 7/8	302-190	3/16 x 1-1/4	302-257	3/8 x 1-1/2
302-050*	1/8 x 5/8	302-121	1/4 x 7/8	302-200	7/32 x 1-1/4	302-270	1/4 x 2-1/8
302-060*	5/32 x 5/8	302-130*	3/16 x 1	302-210	1/4 x 1-1/4	302-280	5/16 x 2-1/8
302-061	3/16 x 5/8	302-140	7/32 x 1	302-214	5/16 x 1-1/4	302-290	3/8 x 2-1/8
302-070	1/8 x 3/4	302-150*	1/4 x 1	302-215	3/8 x 1-1/4	302-291	3/8 x 2-3/4
302-080*	5/32 x 3/4	302-152	5/16 x 1	302-220	1/4 x 1-3/8	302-292	5/16 x 2-3/4
302-090*	3/16 x 3/4	302-160	3/16 x 1-1/8				

*Denotes popular sizes

Sizes not listed can be supplied.

papco WOODRUFF KEY ASSORTMENTS
ASSORTIMENTS CLAVETTES 'WOODRUFF'

GARAGE ASSORTMENT No. 020-020



This assortment contains 100 Woodruff keys in 12 sizes that are needed in every garage. Packed in a sturdy, plastic box.

GARAGE ASSORTMENT No. 020-021

This assortment contains 29 of the following Large size Woodruff Keys. 302-190, 200, 210, 214, 215, 220, 240, 250, 257, 270, 280, 290, 291, 292.



For complete coverage of most tractors and farm machinery use the 020-020 Woodruff Key Assortment together with 020-021.

WOODRUFF KEY MASTER ASSORTMENT No. 020-614

- Contains 210 Woodruff Keys.
- 20 popular sizes.
- Metal box with moulded plastic compartments.
- Actual size illustrations on lid label.
- Refills available in standard packages.
- Sizes: 302-010, 020, 030, 040, 050, 060, 070, 080, 090, 100, 110, 121, 130, 150, 152, 160, 180, 200, 210, 240.



Metal Merchandiser with moulded compartments.

Size: 9-3/4" w. x 13-3/4" l. x 2" d.

A popular Assortment for Garages, Machine Shops and Implement repair use.

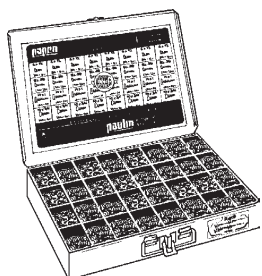

papco SUPER SERVICE ASSORTMENT No. 020-820

Contains 374 Woodruff Keys - 32 sizes. Large size, rigid metal box with high-strength plastic compartments.

For more details see page 9.

Large size: 12" w. x 18" l. x 3" d.



304
Series

papco UNIVERSAL 'O'-RINGS JOINTS TORIQUES UNIVERSEL

Popular standard sizes used in automotive, agricultural and industrial equipment maintenance. 'Papco' O-Rings are made of a special Nitrile Compound (Buna-N Rubber) for petroleum oils, greases, automotive gasoline, alcohols, glycols, fuel oil, propane and many other fluids.

Assembly instructions: Be sure all parts are perfectly clean. Then lubricate the O-Ring. For an external groove, stretch the ring over the shaft or fold the ring into an internal groove. Avoid excessive twisting.

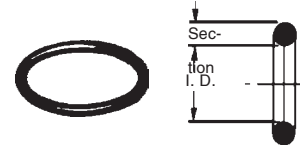

Order by Stock Number

Standard Package contains 25 'O' Rings

Stock No.	Nominal Size			Stock No.	Nominal Size		
	I.D.	O.D.	Section		I.D.	O.D.	Section
304-001	1/8	1/4	1/16	304-022	1-3/16	1-7/16	1/8
304-002	5/32	9/32	1/16	304-023	1-1/4	1-1/2	1/8
304-003	3/16	5/16	1/16	304-024	1-5/16	1-9/16	1/8
304-004	7/32	11/32	1/16	304-025	1-3/8	1-5/8	1/8
304-005	1/4	3/8	1/16	304-026	1-7/16	1-11/16	1/8
304-006	5/16	7/16	1/16	304-027	1-1/2	1-3/4	1/8
304-007	3/8	1/2	1/16	304-028	1-1/2	1-7/8	3/16
304-008	3/8	9/16	3/32	304-029	1-5/8	2	3/16
304-009	7/16	5/8	3/32	304-030	1-3/4	2-1/8	3/16
304-010	1/2	11/16	3/32	304-031	1-7/8	2-1/4	3/16
304-011	9/16	3/4	3/32	304-033	2-1/8	2-1/2	3/16
304-012	5/8	13/16	3/32	304-035	2-3/8	2-3/4	3/16
304-013	11/16	7/8	3/32	304-037	2-5/8	3	3/16
304-014	3/4	15/16	3/32				
304-015	3/4	1	1/8				
304-016	13/16	1-1/16	1/8				
304-017	7/8	1-1/8	1/8				
304-018	15/16	1-3/16	1/8				
304-019	1	1-1/4	1/8				
304-020	1-1/16	1-5/16	1/8				
304-021	1-1/8	1-3/8	1/8				

UNIVERSAL 'O' RING GARAGE ASSORT. No. 020-072



Contains 78 rings, 15 sizes from 1/8" to 3/4" I.D. Packed in a clear plastic box.

UNIVERSAL 'O' RINGMASTER ASSORTMENT No. 020-626

Contains 300 rings, 30 sizes, in sturdy metal box with locking lid and carrying handle. Illustrated label with actual size illustrations to make correct selection easy. Size: 9-3/4" w. x 13-3/4" l. x 2" d.



020-626

UNIVERSAL 'O' RING ASSORTMENT No. 020-960

Contains 382 rings, 30 sizes from 1/8" to 1-3/4" I.D. Popular assortment of inch-series. 'O' Rings packed in a durable ABS plastic dispensing box with individual posts and compartments, and with a cross-section (thickness) moulded gauge. Size chart is shown on cover.

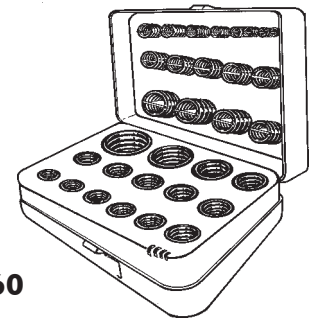

020-960

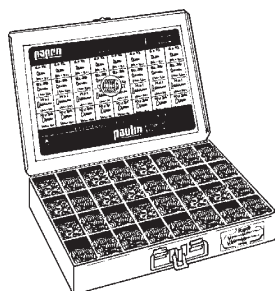

papco SUPER SERVICE ASSORTMENT No. 020-821

Contains 390 'O' Rings - 30 sizes. Large size, rigid metal box with high-strength plastic compartments. For more details see page 9. Large size: 12" w. x 18" l. x 3" d.



313
Series

papeo AXLE SHAFT KEY STOCK
BARRES DE CLEF

'Papco' AXLE KEY STOCK IN 12" lengths enables the mechanic to make up any size axle key on short notice and with a minimum investment. Standard Package contains six 12" lengths.

AXLE KEY STOCK ASSORTMENT
No. 020-853

Contains 20 Lengths of Key Stock in all popular sizes.

All 12" Long



Order by Stock Number

Stock No.	Size	Stock No.	Size
313-174	3/16 x 3/16	313-180	1/2 x 1/2
313-176	1/4 x 1/4	313-181	1/4 x 5/16
313-177	5/16 x 5/16	313-182	1/4 x 3/8
313-178	3/8 x 3/8	313-183	5/16 x 3/8
313-179	7/16 x 7/16	313-185	3/8 x 7/16



ASSORTMENT No. 020-906

This handy assortment contains 50 lengths - 10 each of 3/16", 1/4", 5/16", 3/8" and 1/2" sq. x 12" long Axle Key Stock. Make your own keys for axle shafts, pulley shafts and many other applications where a straight key is needed. Attractive, all-metal merchandiser can stand on counter or hang on wall.

papeo HOLE (BUTTON) PLUGS
BOUCHONS DE TROU

314
Series

Used to plug holes in instrument panel, cowl, fire wall, etc. Made of nickel plated steel with spring action prongs. They snap into place and can be removed and re-inserted.



Order by Stock Number Standard package 50 Plugs

Stock No.	Fits Hole Size	Stock No.	Fits Hole Size
314-018	3/8"	314-026	3/4"
314-020	7/16"	314-030	1"
314-022	1/2"	314-034	1-1/4"
314-024	5/8"		

For Plastic Button Plugs see page 107.



GARAGE ASSORTMENT No. 020-028

Contains 47 hole plugs, including each of the sizes listed. Ideal for plugging aerial, accessory or switch holes. Packed in clear plastic container.

314
Series

papeo MECHANICS' WIRE
BROCHE DE MECANICIEN

STOVE PIPE WIRE

'Papco' Mechanics' Wire is soft annealed for general use in garage or workshop. Used as locking wire in drilled bolts in bearings and flywheels.

Packed on sturdy plastic spools - saves time - eliminates waste.

Order by Stock Number

Stock No.	Two Pound Spools
314-218	18 ga. (.047") 330 ft. per spool

Note: Length shown is approximate.





312
Series

papco

TAPER PINS
GOUPILLES CONIQUE



Standard Taper 1/4" per foot or .0208" per inch.
Diameter is measured at the large end.

Order by Stock Number

Standard Package 25 pieces.

Stock No.	Dia. And Length	Dia. Large End.	Approx. Dia.	Stock No.	Dia. And Length	Dia. Large End.	Approx. Dia.
312-001	00 x 1"	.141	9/64	312-014	4 x 1-1/2"	.250	1/4
312-002	00 x 1-1/2"	.141	9/64	312-015	4 x 2"	.250	1/4
312-003	0 x 1"	.156	5/32	312-016	4 x 2-1/2"	.250	1/4
312-004	0 x 1-1/2"	.156	5/32	312-017	5 x 1-1/2"	.289	19/64
312-005	1 x 1"	.172	11/64	312-018	5 x 1-3/4"	.289	19/64
312-006	1 x 1-1/2"	.172	11/64	312-019	5 x 2"	.289	19/64
312-007	1 x 2"	.172	11/64	312-020	5 x 2-1/2"	.289	19/64
312-008	2 x 1-1/4"	.193	3/16	312-021	6 x 2"	.341	11/32
312-009	2 x 1-1/2"	.193	3/16	312-022	6 x 2-1/2"	.341	11/32
312-010	2 x 2"	.193	3/16	312-023	6 x 3"	.341	11/32
312-011	3 x 1-1/4"	.219	7/32	312-024	7 x 2-1/2"	.409	13/32
312-012	3 x 1-1/2"	.219	7/32	312-025	7 x 3"	.409	13/32
312-013	3 x 2"	.219	7/32				

Taper Pins Sizes No. 7/0 to No. 10 can be supplied.

GARAGE ASSORTMENT No. 020-050

GARAGE ASSORTMENT No. 020-051

Contains 46 Taper Pins. 18 sizes from 312-001 to 020. Needed in every garage. Packed in Plastic Box.



For farm Equipment use. Contains 36 Taper Pins. 10 sizes from 312-014 to 025. These large size pins are for Tractor and Farm implement use. Combine with Asst. No. 020-050 for complete coverage.



MASTER ASSORTMENT No. 020-610

Contains 100 Taper Pins 20 sizes from 2/0 x 1" to No. 6 x 3". Packed in an all metal container with hinged lid and carrying handle.

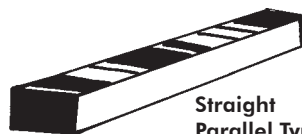

Straight Parallel Type

papco **AXLE KEYS**
BARRES DE CLEF

313
Series

'Papco' Axle Keys are made from special S.A.E. Key Steel, supplied in various sizes to service all cars and trucks.

Order by Stock Number

Standard Package contains 12 Axle Keys

Stock No.	Size	Stock No.	Size	Stock No.	Size
313-078	3/16 x 3/16 x 1	313-115	1/4 x 5/16 x 3-1/4	313-139	1/4 x 3/8 x 3-1/4
313-105	1/4 x 1/4 x 2-7/8	313-124	5/16 x 5/16 x 2-3/4	313-144	5/16 x 3/8 x 3-3/4
313-107	1/4 x 1/4 x 3-1/8	313-127	5/16 x 5/16 x 3-1/8	313-147	5/16 x 7/16 x 3
313-111	1/4 x 5/16 x 2-1/2	313-136	1/4 x 3/8 x 2-5/8	313-152	3/8 x 3/8 x 3-3/4

AXLE KEY ASSORTMENT
No. 020-862

This assortment contains 40 keys made up of the 12 sizes listed above.





■ **QUALITY**

"301" Stainless Steel Band and Housing.
Hi-strength Hex Plated Steel Screw.
No loose parts.

■ **EASY TO USE**

Goes on with Hose in position.
Combination Hex Screw tightens with screw Driver or Wrench.

307 Series



308 Series

■ **RANGE**

Wide size range for each clamp.

■ **STRENGTH**

Wide band for even pressure.
Won't cut hose.
Full-formed teeth will never slip.

■ **ALL STAINLESS STEEL
308 Series**

'Papco' 'Sealtite' Hose Clamps are manufactured from the highest quality materials for reliable operation in any Automotive or Industrial applications. The aircraft principle of the Worm Gear drive gives this clamp a powerful sealing action that meets the toughest requirements. Standard clamp features '301' (18.8) Stainless Steel band and housing with a zinc plated steel screw. The All-Stainless Steel clamp Features a '301' (18.8) Stainless Steel band and housing with a '305' Stainless Steel Screw.

Standard Package contains 10 Hose Clamps

Part Number		Nominal Size	Fits Hose O.D.	Part Number		Nominal Size	Fits Hose O.D.
Standard	All-Stainless			Standard	All-Stainless		
307-001	308-001	5/16"	7/32" - 5/8"	307-032	308-032	2"	1-9/16" - 2-1/2"
307-002	308-002	7/16"	5/16" - 7/8"	307-036	308-036	2-1/4"	1-13/16" - 2-3/4"
307-008	308-008	1/2"	7/16" - 15/16"	307-040	308-040	2-1/2"	2-1/16" - 3"
307-010	308-010	5/8"	9/16" - 1-1/16"	307-044	308-044	2-3/4"	2-5/16" - 3-1/4"
307-012	308-012	3/4"	5/8" - 1-1/4"	307-048	308-048	3"	2-9/16" - 3-1/2"
307-016	308-016	1"	11/16" - 1-1/2"	307-052	308-052	3-1/4"	2-13/16" - 3-3/4"
307-020	308-020	1-1/4"	13/16" - 1-3/4"	307-056	308-056	3-1/2"	3-1/16" - 4"
307-024	308-024	1-1/2"	1-1/6" - 2"	307-060	308-060	3-3/4"	3-5/16" - 4-1/4"
307-028	308-028	1-3/4"	1-5/16" - 2-1/4"	307-064	308-064	4"	3-13/16" - 4-1/16"

papco **HOSE CLAMP 'FLEX-DRIVER'**

No. 307-100



This handy tool makes short work of clamp installation and removal in 'hard-to-reach' places. High quality, flexible Swedish steel shaft with a 5/16" hex socket and a durable, plastic handle for comfort and maximum torque. Includes two 5/8" heater hose clamps. Eliminates slipping and stripping of hose clamp screws. Individually skin-packed on a colourful point-of-purchase display card.

BONUS
Two 5/8" Sealtite Hose Clamps

For 'Hard-to-reach' places!



papco
'SEALTITE' HOSE CLAMPS

Convenient skin-packed cards contain two (2) 'Sealtite' Worm Gear Hose Clamps.

Order by Card Number

Card No.	Nominal Size	Fits Hose O.D.
307-101	5/16"	7/32" - 5/8"
307-110	5/8"	9/16" - 1-1/16"
307-116	1"	11/16" - 1-1/2"
307-124	1-1/2"	1-1/16" - 2"
307-132	2"	1-9/16" - 2-1/2"



Papco 'SNAPPER' HOSE CLAMPS COLLIERS DE BOYAUX 'SNAPPER'

'Papco' Nylon 6/6 Snapper Hose Clamps form an instant grip on hoses in automobile repair or whenever a quick application is required. Teeth mesh together and are set by using pliers and released by sliding jaws sideways. Will not rust - non-conductive. For pressures up to 120 p.s.i. UV stabilized.

Order by Stock Number

Standard Package 10 Clamps

Stock No.	Fits Hose I.D.	Clamp Range		Stock No.	Fits Hose I.D.	Clamp Range	
		Minimum	Maximum			Minimum	Maximum
307-505	5/16"	19/64"	11/32"	307-516	1"	63/64"	1-9/64"
307-506	3/8"	23/64"	25/64"	307-517	1-1/8"	1-1/8"	1-19/64"
307-507	7/16"	13/32"	29/64"	307-519	1-3/16"	1-7/32"	1-13/64"
307-508	1/2"	33/64"	19/32"	307-520	1-1/4"	1-9/32"	1-19/32"
307-509	9/16"	9/16"	21/32"	307-522	1-1/2"	1-15/32"	1-23/32"
307-510	5/8"	39/64"	45/64"	307-524	1-3/4"	1-47/64"	2-1/64"
307-512	3/4"	3/4"	27/32"	307-526	2"	2"	2-15/64"
307-513	13/16"	25/32"	29/32"	307-528	2-1/4"	2-1/4"	2-37/64"
307-514	7/8"	55/64"	63/64"				



Papco FUEL INJECTION HOSE CLAMPS COLLIERS DE BOYAUX POUR INJECTEUR D'ESSENCE

Manufactured specifically for all fuel injection applications. Non-perforated band is aluzinc coated carbon steel with a zinc plated carbon steel screw and nut. Band width approx. 3/8".

Order by Stock Number

Standard Package 10 Clamps

Stock No.	Fits Hose I.D.	Clamp Range		Stock No.	Fits Hose I.D.	Clamp Range	
		Minimum	Maximum			Minimum	Maximum
307-550	1/4"	7/16"	1/2"	307-552	3/8"	9/16"	5/8"
307-551	5/16"	1/2"	19/32"				

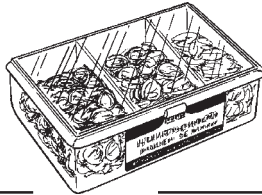

FUEL INJECTION HOSE CLAMP GARAGE ASSORTMENT No. 020-096

Contains 28 Hose Clamps - 3 sizes in a compartmentized, clear styrene plastic box.

Papco CONSTANT TENSION HOSE CLAMPS COLLIERS DE BOYAUX A TENSION CONSTANTE



Metal pinch or squeeze type clamp commonly used on fuel, vacuum and other low pressure lines.

Order by Stock Number

Std. Pkg. 25 Clamps

Stock No.	Fits Hose O.D.	Max. Clamp Dia. Open	Colour
307-560	3/8"	.321	Black
307-561	7/16"	.405	Green
307-562	1/2"	.460	Red
307-564	5/8"	.583	Olive
307-566	3/4"	.645	Black
307-568	1"	.910	Black

CONSTANT TENSION HOSE CLAMP GARAGE ASSORTMENT No. 020-097

Contains 60 Clamps - 6 sizes packed in a transparent, plastic container with a hinged lid.

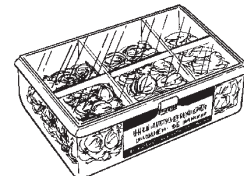

310
Series

papeo

PUSH-PULL CONTROLS
CABELES DE CONTROL



For choke, throttle, hood, air vents, heater valves, mowers, snow blowers, power take-off etc.
All controls are individually packaged for point of sale display. Order by Stock Number.

UTILITY CONTROLS



Round black knob to complete any dash panel.
2" travel, 3/16 OD. Gal. Casing, .054" HC Wire, 3/8-24 housing thread
Stock No. 310-120 60" long
Stock No. 310-121 72" long

STANDARD ASSEMBLIES



Round lustrous black knob. Includes mounting bracket and finishing washer Plated.
2" travel, 3/16 OD. Casing, .054" HC Wire, 3/8-24 housing thread
Stock No. 310-136 180" long

'T' HANDLE ASSEMBLY



Chrome plated metal handle. Plated assembly. Includes mounting bracket and finishing washer.
2" travel, 3/16 OD. Casing, .054" HC Wire, 3/8-24 housing thread
Stock No. 310-152 84" long

'T' HANDLE HEAVY DUTY LOCKING ASSEMBLY



Locks with half turn. Brass Clutch. Chrome Handle. Includes dash mount bracket and finishing washer. Full floating core does not turn with handle.
2" travel, 3/16 OD. Casing, .062" HC Wire, 3/8-24 housing thread
Stock No. 310-173 Heavy Duty Housing. 108" long

'T' HANDLE HEAVY DUTY LOCKING ASSEMBLY



Turn and lock. Brass locking clutch. Chrome Handle. Plated. Heavy Duty Housing with 2" thread length. Full floating core wire.
2" travel, 3/16 OD. Casing, .062" HC Core Wire, 1/2-20 housing thread
Stock No. 310-181 72" long

MARINE CONTROL



For boats, other marine and hostile environment applications. Casting is 3/16" dia. REINFORCED NYLON. 'T' Handle is chrome plated. Brass housing. Full floating core wire.
2" travel, 3/16" Vinyl Coated casing w/HDPE Liner, .062" Stainless Core Wire, 3/8-24 housing thread.
Stock No. 310-183 108" long

POWER TAKE OFF CONTROLS



Used primarily as dash mounted power takeoff control on trucks and mobile equipment. Nylon lined, metal reinforced vinyl casing. Plated for corrosion resistance. Large 2" dia. round plastic knob. 7/16-20 x 1-1/2" long housing. Includes mounting nut and lock washer. Individually boxed.
4" travel, 5/16" Vinyl Coated Casing, .093" Stainless Core Wire, 7/16-20 housing thread
Stock No. 310-194 120" long
Stock No. 310-198 240" long



310
Series

papeo HEAVY DUTY VERNIER CONTROL CONTROLE VERNIER EXTRA-ROBUSTE

Recommended for heavy truck, bus, agricultural and off-highway uses. Heavy duty easy-action control for critical adjustments. This accurate Vernier control has a unique three prong locking collar. Designed for one-hand setting and locking in place. Make accurate fine adjustments by rotating knob - depress

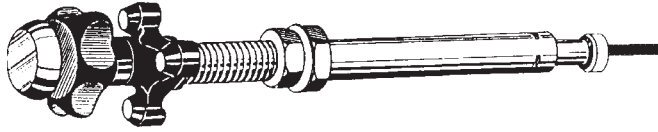

central button and push or pull for coarse setting. Long life working parts are brass and stainless, weather resistant 5/16" O.D. reinforced vinyl casing and liner. .072" stainless steel core wire x 120" long. Housing is 3/4-16 x 2 9/16" long with hex panel nut, mounting nut and lock washer. Travel is 3 5/8".

Stock No. 310-216

120" long

Individually boxed

CHOKE CONVERSION KITS TROUSSES DES CONVERSION A L'ETRANGLEUR

Helps eliminate hard winter starts. Allows driver to control choke. Instant control of air and gas mixture from dash.

Order by Stock Number

Complete instructions included.

Individually Packaged

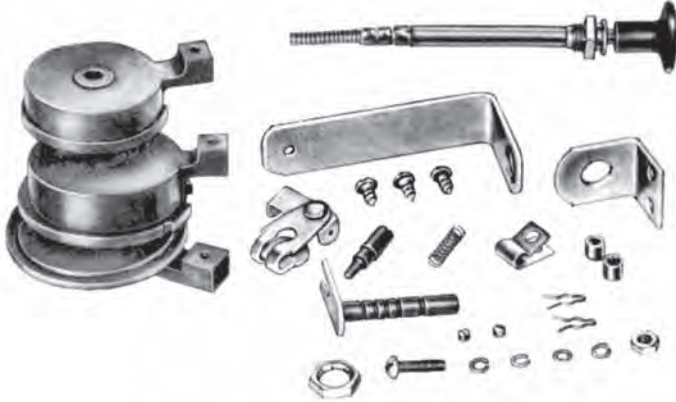

No. 310-245
No. 310-246
No. 310-250

SEMI-AUTOMATIC TYPE
MANUAL TYPE

SEMI-AUTOMATIC TYPE

Allows manual override. Exclusive "Magic-Link" lets engine breathe even under full choke.

Stock No. 310-245
Fits AMC, GM, Ford and Chrysler cars. 60" cable.

Stock No. 310-246
Fits all light and medium domestic trucks. Has long 108" cable.

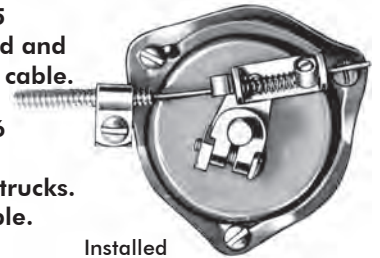

Installed

COMPLETE MANUAL OPERATION

Stock No. 310-250
Universal kit. For most American made cars. Cable is 60" long

UNIVERSAL SPEEDOMETER CABLE KIT TROUSSE DE CABLE POUR INDICATEUR DE VITESSE

This complete kit includes 81" long standard multi-strand flexible shafting with .104" squared lower end. Cut shafting to length of original speedometer cable and attach the square tip with the staking tool provided. Fits most cars, trucks and RV's.

Stock No. 310-281

Individually Packaged

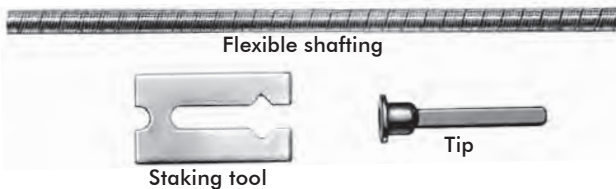

Flexible shafting



Staking tool



Tip

81" Flexible shafting, tip and tool.

Stock No. 310-281

CONTROL WIRE STOPS BLOQUERS POUR CONTROLE DE BROCH

Universal type. For push-pull controls, choke control wires, hood release latches and throttle cables. Position cable stop against control arm of lever and tighten screw.

Order by Stock Number

Standard Package 25 pieces

Stock No. 310-353



1/4" for 1-16" wire

Stock No. 310-354



3/8" for 1/8" wire



CARBURETOR and THROTTLE RETURN SPRINGS
RESSORTS DE CARBURATEUR et SOUPAPE DE REGLAGE



Stock No.
311-001

Universal Throttle Return Spring. Can be adapted for use on all Carburetors and Accelerator pedals. Spring measures 12" overall and plain end can be cut to required length. Standard Package contains 12 springs.

Stock No.
311-002

Carburetor Return Spring. Attach to screw on carburetor body and hook to throttle valve arm. Acts as a helper spring for throttle return - prevents racing and sticking accelerator. For Chevrolet, G.M. and Chrysler cars. 12 Springs per package.



CARBURETOR SPRING DISPLAY
No. 020-878

Contains 12 each No. 311-001, No. 311-002 Springs Mounted on attractive three colour merchandising display card.



UNIVERSAL PEDAL RETURN SPRINGS
RESSORTS REVENIR DE PEDALE UNIVERSEL

FOR ALL BRAKE AND CLUTCH PEDALS



Standard Package 12 Springs

No. 311-101, 18-1/2" overall x 13/16" O.D. x 2" Coil x 7/64" Dia. Wire.

No. 311-103, 18-1/2" overall x 3/4" O.D. x 3-1/2" Coil x 1/16" Dia. Wire.

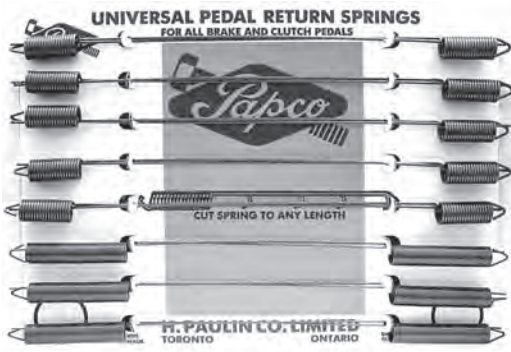

PEDAL RETURN SPRING DISPLAY
No. 020-885

Contains 16 Pedal Return Springs, (10) No. 311-101, (6) No. 311-103. Mounted on attractive three colour merchandising display card. These universal springs can be cut to fit all brake and clutch pedals.



311
Series

papeo

UTILITY SPRINGS
RESSORTS D'UTILITE

Compression Type

Extension Type

In sizes suitable for most requirements

COMPRESSION TYPE



Order by Stock Number

Standard Package 12 Springs

Stock No.	Outside Dia.	Length	Wire Size	Stock No.	Outside Dia.	Length	Wire Size
311-639	3/32"	7/8"	.020"	311-601	3/8"	11-1/2"	.051"
311-676	3/16"	5"	.026"	311-655	7/16"	2-3/4"	.045"
311-615	1/4"	1-1/2"	.041"	311-622	7/16"	3"	.062"
311-677	1/4"	5"	.034"	311-682	7/16"	5"	.062"
311-618	9/32"	2"	.022"	311-683	1/2"	5"	.072"
311-678	5/16"	5"	.047"	311-620	5/8"	2-1/2"	.081"
311-679	5/16"	5"	.054"	311-646	5/8"	3"	.062"
311-656	3/8"	2"	.034"	311-653	5/8"	3-3/8"	.080"
311-650	3/8"	2-3/4"	.045"	311-602	5/8"	11-1/2"	.057"
311-680	3/8"	5"	.054"	311-603	7/8"	10"	.081"
311-681	3/8"	5"	.062"				

EXTENSION TYPE



Stock No.	Outside Dia.	Length	Wire Size	Stock No.	Outside Dia.	Length	Wire Size
311-633	1/8"	9/16"	.018"	311-630	5/16"	5-3/8"	.041"
311-684	1/8"	15/16"	.020"	311-608	5/16"	6"	.034"
311-634	1/8"	1-3/8"	.018"	311-659	5/16"	6-3/4"	.034"
311-612	5/32"	2-1/8"	.028"	311-658	5/16"	7-1/4"	.045"
311-636	3/16"	1-1/8"	.025"	311-610	11/32"	3"	.041"
311-616	3/16"	1-1/4"	.014"	311-685	3/8"	1-7/8"	.031"
311-623	3/16"	2-1/2"	.028"	311-629	3/8"	4-3/4"	.045"
311-627	7/32"	2-1/4"	.034"	311-631	3/8"	11"	.054"
311-617	1/4"	1-1/8"	.020"	311-626	7/16"	3-1/8"	.041"
311-624	1/4"	3-3/4"	.034"	311-606	7/16"	5"	.062"
311-609	1/4"	4"	.028"	311-661	7/16"	6-3/8"	.054"
311-607	1/4"	5-3/4"	.028"	311-605	7/16"	6-1/2"	.041"
311-635	9/32"	1-1/8"	.020"	311-611	1/2"	4-1/2"	.062"
311-628	9/32"	1-7/8"	.034"	311-604	1/2"	5-1/2"	.080"
311-625	5/16"	2-1/2"	.034"	311-632	1/2"	11"	.062"



MASTER ASSORTMENT No. 020-637

Assortment No. 020-637 contains 250 Utility Springs, consisting of Compression, Extension and Ignition Springs. With this Assortment you will find a spring suitable for most any replacement. The attractive label shows the dimensions, stock number and list price of each spring. Refills may be ordered from standard stock.

Assortment is packed in a sturdy, sectional metal container complete with self-locking handle.



**GARAGE ASSORTMENT
No. 020-063**

Contains 100 Small Coil Springs
Compression and Extension Types included.

Packed in Plastic Box.



**EXTENSION SPRING
ASSORTMENT No. 020-860**

Contains 30 Extension Springs.
12 Popular Sizes.



**UTILITY ASSORTMENT
No. 020-342**

Contains 83 Extension and Compression Springs –
15 Popular Sizes.

Packed in a sturdy fibre-board container.



**COMPRESSION SPRING
ASSORTMENT No. 020-861**

Contains 40 Compression Springs.
12 Popular Sizes.





305
Series

papco BRASS SHIM STOCK FEUILLES POUR CALE LAITON



"Papco" BRASS SHIM STOCK is uniform and accurate in thickness, hard temper and is ideal for cutting and shaping. The 6" wide x 100" long rolls are supplied in fibre dispenser tubes for easy use.

Order by Stock Number



THREE INCH WIDTHS

36 Inch Strips

Stock No.	Thickness	Stock No.	Thickness
305-301	.001	305-307	.007
305-302	.002	305-308	.008
305-303	.003	305-310	.010
305-304	.004	305-312	.012
305-305	.005	305-315	.015
305-306	.006		

SIX INCH WIDTHS

100 Inch Strips

Stock No.	Thickness	Stock No.	Thickness
305-601	.001	305-608	.008
305-602	.002	305-609	.009
305-603	.003	305-610	.010
305-604	.004	305-612	.012
305-605	.005	305-615	.015
305-606	.006	305-620	.020
305-607	.007	305-625	.025

papco BRASS SHIM STOCK ASSORTMENTS ASSORTIMENTS FEUILLES POUR CALE LAITON



No. 020-850

papco
BRASS SHIM STOCK
Strip Assortment
020-850

This assortment consists of 5 strips of Brass Shim Stock 3" x 8" (120 sq. in.) in these thicknesses: .001, .002, .003, .005, .010.

Packed in individual envelope.

No. 020-863

This useful assortment consists of 5 strips of Brass Shim Stock 3" x 18" (270 square inches).

One strip each .001, .002, .003, .005, .010.

Each assortment is packed in a sturdy container.



305
Series

papco STEEL SHIM STOCK FEUILLES POUR CALE ACIER



"Papco" STEEL SHIM STOCK is hard shim temper and uniform in thickness. Supplied in Strips 100 inches long by 6 inches wide as listed. Each strip is packed in a sturdy fibre tube.

Six inches wide by 100 inches long.



Stock No.	Thickness	Stock No.	Thickness
306-601	.001	306-604	.004
306-602	.002	306-605	.005
306-603	.003	306-606	.006

Stock No.	Thickness	Stock No.	Thickness
306-607	.007	306-612	.012
306-608	.008	306-615	.015
306-610	.010	306-620	.020

Note: Stainless Steel Shim Stock available – price on application.

400
Series

papeco NYLON CABLE CLAMPS
COLLIERS DE CABLE NYLON

'Papco' 6/6 Black Nylon Cable Clamps are tough, resilient light-weight and highly resistant to wear, most chemicals such as gasoline, oil etc. and destructive U-V rays. Used to secure cables, pipes, tubing, wire etc. in automotive, marine, appliance, commercial and residential applications. All nylon clamps provide excellent insulation characteristics.



Order by Stock Number

Stock No.	Cable Size	Clamp Width	Std. Pkg.	Stock No.	Cable Size	Clamp Width	Std. Pkg.
400-522	1/4	3/8	50	400-528	5/8	1/2	25
400-524	3/8	3/8	50	400-530	3/4	1/2	25
400-526	1/2	3/8	50	400-532	1"	1/2	15

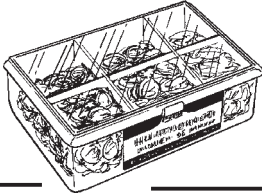

NYLON CABLE CLAMP
GARAGE ASSORTMENT No. 020-088

Contains 40 pieces - 6 sizes of Nylon Cable Clamps listed above. Packed in a sturdy, clear, plastic box.

400
Series

papeco STORAGE ORGANIZERS
CROCHETS D'ENTREPOSAGE

Rust resistant, vinyl coated screw hooks for organizing lawn and garden equipment, bicycles, hand tools, ladders, hoses, extension cords etc. Drill 3/16" hole, lubricate threads with beeswax or soap and screw in hook completely into surface.

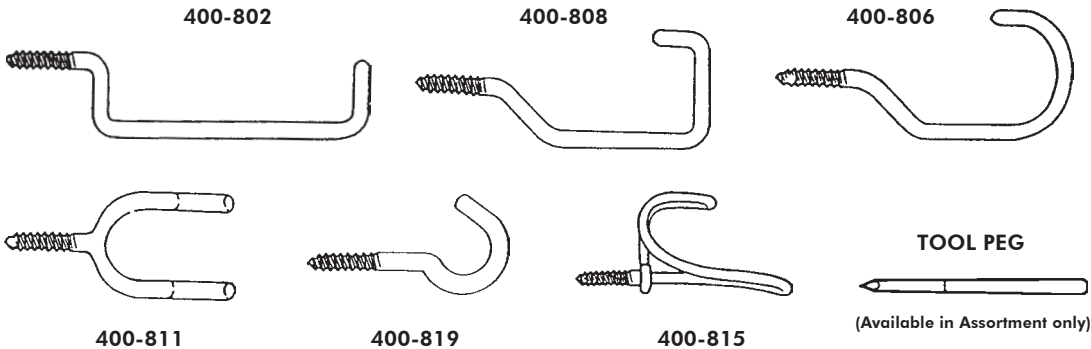

Order by Stock Number

Standard Package 10 Pieces

Stock No.	Description	Over. Length	Stock No.	Description	Over. Length
400-802	LADDER HOOK	7-1/2"	400-811	TOOL HOOK	4"
400-806	BICYCLE HOOK	6"	400-815	COAT/HAT HOOK	3-1/2"
400-808	UTILITY HOOK	6"	400-819	SCREW HOOK	4"

papeco STORAGE ORGANIZERS
KIT No. 400-820

Contains 17 pieces of Vinyl Coated Storage Hooks listed above - 7 sizes. 2pc. 400-802, 2pc. 400-806, 2pc. 400-808, 2pc. 400-811, 2pc. 400-815, 2pc. 400-819 and 5 Tool Pegs. Attractive, clamshell package with instructions and applications. Order by Kit Number.

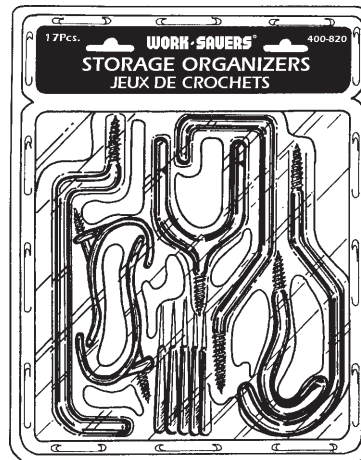



400 Series

Papco SNAP FASTENERS ATTACHES 'SNAP'

DURABLE FASTENERS

'Papco' Snap Fasteners provide superior snap action and holding strength. Snap Fasteners are self-piercing and made of heavy duty, nickel plated brass. Used in a variety of materials on boats, tents, sporting goods, RV's, luggage, awnings, clothing - camper, convertible and tonneau tops. Order by Stock Number

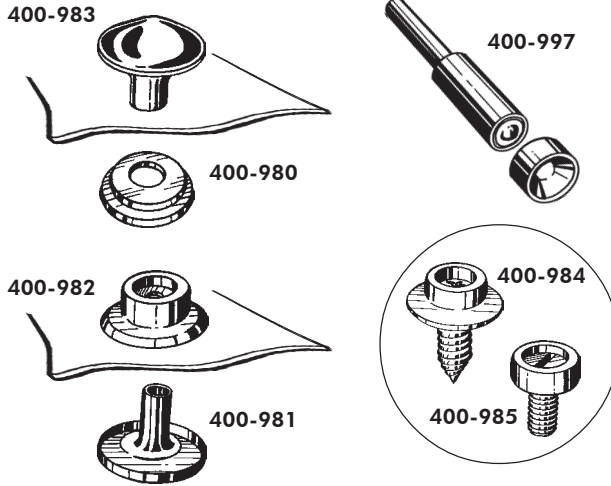

Stock No.	Description	Std. Pkg.
400-980	3/8 Socket - Normal Action	25
400-981	3/8 Post - 10mm dia.	25
400-982	3/8 Stud	25
400-983	3/8 Cap 24mm dia.	25
400-984	3/8 Screw Stud No. 8	25
400-985	3/8 Bolt Stud 10-32	25
400-997	Installation Tool	1

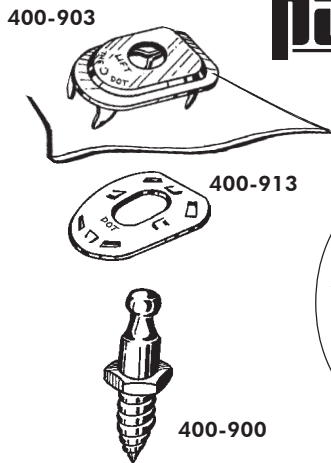

Papco LIFT-THE-DOT FASTENERS ATTACHES LIFT-THE DOT

Strong, heavy duty fasteners that lock on 3 sides. Opened by lifting the fourth side where the dot and trademark appear.

Order by Stock Number

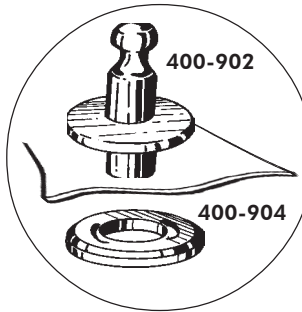

Stock No.	Description	Std. Pkg.
400-900	No. 8 Wood Screw Stud	25
400-902	Stud	25
400-903	Socket	25
400-904	Washer	25
400-913	Back Plate	25

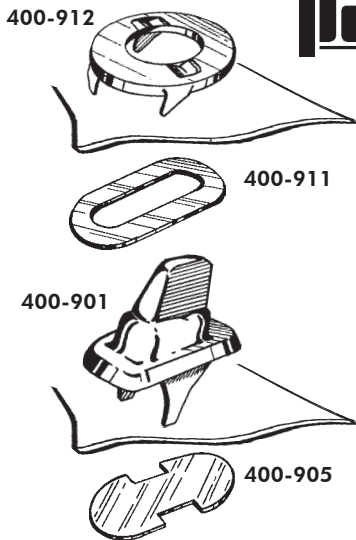

Papco TURN FASTENERS ATTACHES TOURANT

Also known as Common Sense Fasteners

'Papco' Turn Fasteners are positive locking and never open accidentally. Spring mechanism contained in stud holds fastener under tension until turned by hand.

Order by Stock Number

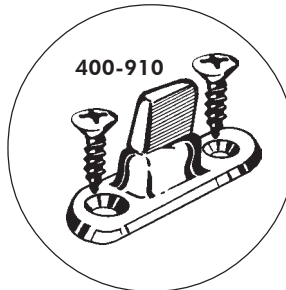

Stock No.	Description	Std. Pkg.
400-901	Turn Button	10
400-905	Back Plate	25
400-910	Turn Button	10
400-911	Washer	25
400-912	Grommet	25

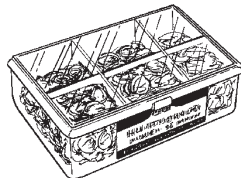

GARAGE ASSORTMENT No. 020-091

Contains 25 pieces including installation tool of the most popular Snap Fasteners packed in a sturdy, transparent box.

GARAGE ASSORTMENT No. 020-092

Contains 20 pieces of Lift-the-Dot® Fasteners in a clear, compartmentized plastic box.

GARAGE ASSORTMENT No. 020-093

Contains 20 pieces of 'Papco' Turn Fasteners packed in a clear, plastic container with hinged lid.

400
Series

papco

**BRASS GROMMETS
BAGUES EN LATION**



Solid brass, tooth type grommets are recommended for extra holding power and corrosion resistance. Use grommets on tents, tarpaulins, trucks, sails, awnings, boat covers, pool covers, lawn furniture etc. Available in two sizes: No. 400-958 3/8" I.D. and No. 400-960 1/2" I.D.



Order by Stock Number

Standard Package 10 Pieces per Bag

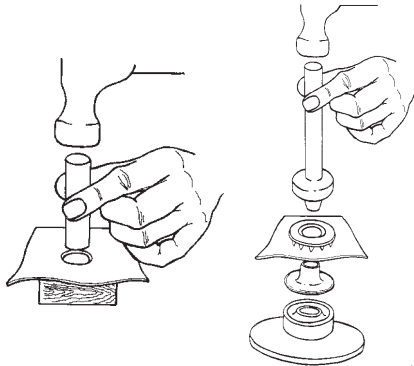

No. 400-968

3/8" GROMMET KIT

Consists of hole punch, flaring punch and anvil base. Includes 10 solid brass 3/8" grommets with tooth type washers. Packed with instructions in a re-usable hang-up vinyl pouch. Professional quality tool kit.

No. 400-970

1/2" GROMMET KIT

Professional setting tool and ten 1/2" grommets as above.

400
Series

papco

**MAGNETIC RETRIEVER
RAMASSE-PIECES AIMANTE**

No. 400-024



This chrome plated, telescopic tool has a powerful, permanent NEODYMIUM magnetic tip that will lift over 3.5 pounds. The retriever can be used to pick-up steel objects, dropped tools, fasteners etc. from hard-to-reach places. Six inches long with a handy pocket clip, extends to over 24". Can also be used as a presentation pointer.

Order by Stock Number

Individually Carded

papco **HEAVY-DUTY LIFTING MAGNET**
AIMANT RECUPERATEUR
USAGE INTENSE

No. 400-020

For commercial, recreational or household use. Ideal for removing dents in metal. Retrieve submerged tools, metal parts, tackle, fishing poles etc. Locate, lift, hold or hang steel articles.

Lifts up to 150 lbs.

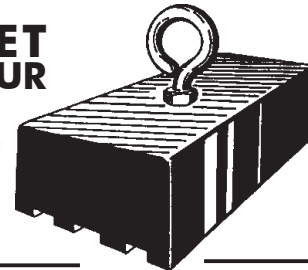

Order by Stock Number

Individually Packaged

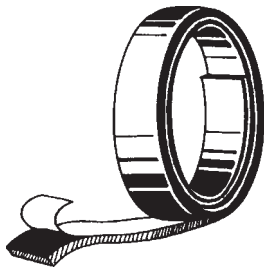

papco **MAGNETIC STRIP**
BANDE MAGNETIQUE

No. 400-010

Flexible, Magnetic Strip with adhesive back, cuts easily with scissors or a knife. Magnetic surface of strip holds small metal objects. Ideal for Body Shops for holding plastic masking material or work orders to vehicle body areas without damaging painted surfaces. Perfect for mounting signs. Size: 1/2" wide x 10 feet long.

Order by Stock Number

Individually Packaged

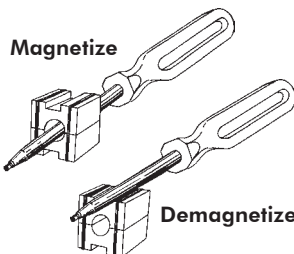

papco **TOOL MAGNETIZER/
DEMAGNETIZER**

No. 400-022

Easy-to-use tool magnetizes screwdrivers, wrenches and other small tools. Pass tool through centre hole of charger to magnetize. To demagnetize pass tool over outside edge of charger several times.

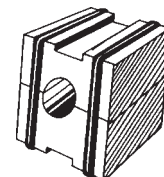

Order by Stock Number Individually Packaged

For Ceramic Block Magnets No. 400-002 see page 81.



558
Series

559
Series

papco® **WHEEL NUTS**
ECROUS DE ROUE

Passenger Car/Light Truck

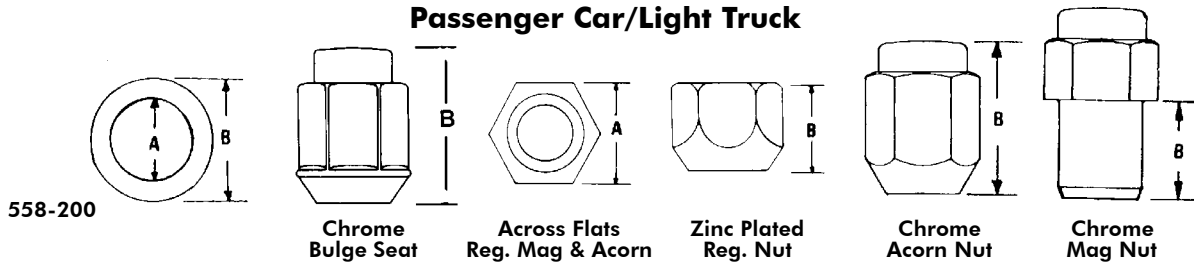

Part No.	Diameter/Type	'A'	'B'	St. Pkg.	Part No.	Diameter/Type	'A'	'B'	St. Pkg.
558-014	7/16-20R Reg.	3/4	9/16	25	558-146	1/2-20 Acorn	13/16	1-3/8	10
558-015	7/16-20L Reg.	3/4	9/16	25	558-148	1/2-20R Acorn Bulge	3/4	1-3/8	10
558-016	1/2-20R Reg.	13/16	5/8	25	558-174	7/16-20 Mag	13/16	3/4	10
558-026	1/2-20L Reg.	3/4	9/16	25	558-176	1/2-20 Mag	13/16	3/4	10
558-027	1/2-20R Reg.	3/4	9/16	25	558-200	Mag Washers	11/16	1	10
558-031	1/2-20L Reg.	13/16	5/8	25	559-060	M10x1.25 Acorn	17mm	21mm	10
558-044	5/8-18R Reg.	1-1/16	21/32	10	559-064	M12x1.25 Reg	19mm	16mm	10
558-045	5/8-18L Reg.	1-1/16	21/32	10	559-065	M12x1.25 Acorn	13/16	1-3/8	10
558-047	9/16-18R Reg.	1	11/16	10	559-070	M12x1.5 Acorn	13/16	1-3/8	10
558-050	9/16-18L Reg.	1	11/16	10	559-075	M12x1.5 Acorn	3/4	1-3/8	10
558-055	5/8-18R Reg.	1	21/32	10	559-077	M12x1.5 Acorn Bulge	19mm	35mm	10
558-057	5/8-18R Flange	1-1/8	1-1/16	10	559-095	M12x1.25 Mag	13/16	3/4	10
558-058	9/16-18R Reg.	1-1/16	21/32	10	559-100	M12x1.5 Mag	13/16	3/4	10
558-061	9/16-18R Reg.	1-1/16	15/16	10	559-125	M12x1.25 Reg	21mm	16mm	10
558-092	9/16-18R Wash. Nut	1-1/16	1	10	559-150	M12x1.5 Reg	19mm	16mm	10
558-100	9/16-18R Reg.	7/8	3/4	10	559-154	M14x1.5 Reg	22mm	21mm	10
558-140	7/16-20 Acorn	3/4	1-3/8	10	559-163	M12x1.5 Reg	19mm	23mm	10
558-144	7/16-20 Acorn	13/16	1-3/8	10	559-172	M12x1.5 Reg	21mm	16mm	10

560
Series

papco® **WHEEL BOLTS**
BOULONS DE ROUE

Passenger Car/Light Truck

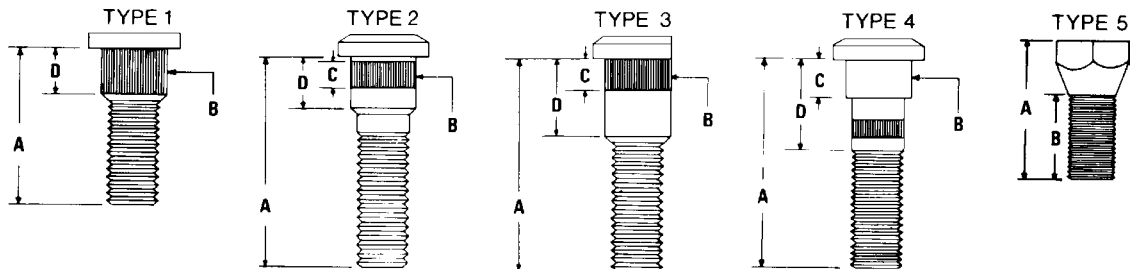

Bare Metal/Métal Nu

Standard Package/Contenant Régulier 10 pcs.

Part No.	Type	Diameter x 'A'	'B'	'C'	'D'	Factory No.
560-018	5	1/2-20 R x 1-7/16	7/8	3/4 HEX	-	
560-019	5	9/16-18 R x 1-7/16	7/8	3/4 HEX	-	
560-032	1	1/2-20 R x 1-3/8	.630	-	.555	2405146
560-033	1	1/2-20 L x 1-3/8	.630	-	.555	2405147
560-034	1	1/2-20 R x 1-1/2	.618	-	.312	1486230
560-039	1	1/2-20 R x 1-5/8	.620	-	.688	2952858
560-040	1	1/2-20 L x 1-5/8	.620	-	.688	2952859
560-041	1	7/16-20 R x 1-3/8	.560	-	.312	3829376
560-090	2	1/2-20 R x 1-5/16	.625	.250	.438	539499
560-095		USE 560-032				399866
560-096	1	7/16-20 R x 1-7/16	.560	-	.530	2534754
560-098	2	7/16-20 R x 1-3/8	.480	.220	.375	1235136
560-102	2	1/2-20 R x 1-5/8	.562	.250	.563	3229187
560-103	2	1/2-20 R x 1-1/2	.665	.300	.540	2513744
560-104	2	1/2-20 L x 1-1/2	.665	.300	.540	2513745
560-105	2	1/2-20 R x 1-13/16	.560	.300	.750	3699680
560-109		USE 560-034				
560-110	4	1/2-20 R x 2	.623	.320	1.000	3736751
560-114	2	7/16-20 R x 1-1/2	.465	.140	.285	9590259/71

For applications of 'Papco' Wheel Parts and newest updates, please see current Wheel Parts catalogue/application guide.



560
Series

papco® **WHEEL BOLTS**
BOULONS DE ROUE



Passenger Car/Light Truck
Specifications and/et Interchange.

Bare Metal/Métal Nu

Standard Package/Contenant Régulier 10 pcs.

Part No.	Type	Diameter x `A`	`B`	`C`	`D`	Factory No.
560-134		USE 560-148				
560-138	2	1/2-20 R x 1-5/8	.535	.250	.325	1235137
560-148	2	1/2-20 R x 1-13/16	.620	.220	.780	3580693
560-153		USE 560-034				
560-154		USE 560-148				
560-155	1	1/2-20 R x 1-5/8	.630	-	.620	3961258
560-160		USE 560-110				
560-161		USE 560-110				
560-163	2	1/2-20 R x 1-7/16	.545	.250	.438	D3AZ-1107B
560-165		USE 560-172				
560-167	2	1/2-20 R x 1-15/16	.587	.220	.625	D6AZ-1107C
560-172	2	1/2-20 R x 1-7/8	.560	.210	.375	D6DZ-1107A
560-173	2	1/2-20 R x 1-3/4	.625	.250	.438	D6AZ-1107A
560-175	2	1/2-20 R x 1-3/4	.665	.312	.530	2959852
560-177		USE 560-148				
560-178		USE 560-110				
560-179	4	5/8-18 R x 2-3/8	.720	.200	1.200	3641662
560-180	4	5/8-18 R x 2-1/16	.655	.312	.906	3496564
560-181	2	5/8-18 R x 2-7/16	.650	.255	.813	3641576
560-182	4	5/8-18 R x 2-9/16	.655	.312	.906	2515316
560-183	4	5/8-18 R x 2-15/16	.650	.335	1.000	3637878
560-184	4	5/8-18 R x 2-1/4	.650	.333	.844	2515310
560-185		USE 560-110				
560-186	2	1/2-20 R x 1-7/8	.612	.250	.600	E0TZ-1107C
560-187	4	1/2-20 R x 1-5/8	.623	.375	.750	5357196
560-268		USE 560-148				
560-269	2	1/2-20 R x 2-1/8	.623	.200	.625	D3TZ-1107AE
560-286	2	1/2-20 R x 2-3/16	.723	-	1.187	4116934
560-287	2	1/2-20 R x 1-29/32	.667	-	.781	6032505
560-289	2	1/2-20 R x 1-29/32	.583	-	.625	6033382
560-298	2	1/2-20 R x 2	.547	-	.687	E6TZ-1107B
560-303	2	9/16-18 R x 3-9/32	.677	-	.937	E5TZ-1107B
560-305	2	9/16-18 R x 2-1/8	.640	-	.562	E6TZ-1107A
560-315	2	1/2-20 R x 1-9/16	.558	.155	.333	E5TZ-1107A
560-348	4	1/2-20 R x 2-1/8	.658	-	.812	4383430
560-355	4	9/16-18 R x 2-13/16	.630	.200	1.125	D0TZ-1107A
560-356	4	9/16-18 L x 2-13/16	.630	.200	1.125	D0TZ-1119A
560-358	2	1/2-20 R x 2	.612	-	.656	E9ZZ-1107A
560-363	2	1/2-20 R x 2-11/32	.651	-	.937	4030779
560-364	2	1/2-20 R x 1-15/32	.618	-	.484	83503053
560-366	2	1/2-20 R x 1-3/4	.650	.370	.740	1229808-9
560-367	2	1/2-20 R x 2	.585	-	.750	F1VY-1107A
560-368	2	1/2-20 R x 1-31/32	.615	-	.531	F0VY-1107A
560-376	2	9/16-18 R x 1-7/8	.620	.230	.750	3997956
560-386	2	7/16-20 R x 1-5/16	.555	.320	.375	9590258
560-390	2	7/16-20 R x 1-1/2	.555	.300	.690	9785156
560-424		USE 560-110				
560-441	4	1/2-20 L x 1-15/16	.625	.378	1.030	2925171
560-458	4	9/16-18 R x 2-5/32	.630	.325	.950	C9TZ-1107C
560-459	2	9/16-18 R x 2-1/8	.623	.325	.500	334388
560-460	2	9/16-18 R x 3	.630	.875	1.062	3988538
560-461	2	9/16-18 R x 3-9/16	.630	.875	1.325	355815
560-468	4	9/16-18 R x 2-1/8	.650	.250	.875	475988
560-469	4	9/16-18 R x 2-1/2	.650	.375	.875	14002236
560-470	4	1/2-20 R x 1-3/4	.625	.200	.740	2955940
560-471	4	1/2-20 L x 1-3/4	.625	.200	.740	2955941
560-472	2	9/16-18 R x 2	.623	.250	.625	C8TZ-1170E
560-473	4	9/16-18 R x 2-5/8	.622	.200	.813	E0TZ-1107B
560-474	2	9/16-18 R x 2-1/2	.620	.240	.740	E4TZ-1107A
560-604	4	7/16-20 R x 1-3/4	.575	.280	.860	3995841

For applications of `Papco` Wheel Parts and newest updates, please see current Wheel Parts catalogue/application guide.

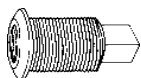

For Heavy Truck Wheel Nuts, Bolts and Studs; Rim Bolts and Nuts
plus Rear Wheel Studs see current Wheel Parts catalogue.





561
Series



METRIC WHEEL BOLTS
BOULONS DE ROUE METRIQUE

Passenger Car/Light Truck
Specifications and/et Interchange.

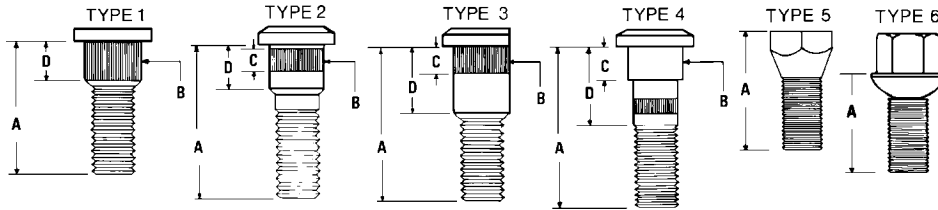

Bare Metal/Métal Nu

Standard Package/Contenant Régulier 10 pcs.

Part No.	Type	Diameter x 'A'	'B'	'C'	'D'	Factory No.
561-100	2	M12 x 1.25R x 39mm	12.9mm	7mm	15.4mm	40222-A0800
561-102	2	M12 x 1.25R x 32mm	12.9mm	7mm	11.6mm	40222-2201
561-106	1	M12 x 1.5R x 38.5mm	14.7mm	5.5mm	-	6500352/073
561-108	1	M12 x 1.5R x 38.5mm	14.3mm	9.5mm	-	5204272
561-109	3	M12 x 1.5R x 40mm	14.8mm	7mm	13mm	-
561-110	2	M12 x 1.5R x 43mm	13mm	6mm	8mm	9590475/76
561-111	2	M12 x 1.5R x 39mm	13mm	6mm	8mm	-
561-112	2	M12 x 1.5R x 40mm	12.5mm	7.5mm	11.3mm	94024217
561-114	1	M12 x 1.5R x 38mm	14.35mm	7mm	-	94025172
561-118	5	M12 x 1.5R x 34mm	19mm Hex	-	-	3238138, D8RZ-1107B
561-120	2	M12 x 1.5R x 45mm	14.3mm	9mm	13mm	90942-02034
561-122	2	M12 x 1.5R x 36mm	14.3mm	6mm	16mm	90942-02035
561-126	2	M12 x 1.5R x 41mm	14.2mm	5mm	12mm	90942-02037
561-128	2	M12 x 1.5R x 38mm	14.2mm	7.5mm	13mm	90942-02014
561-129	2	M12 x 1.5R x 42mm	13mm	7mm	12mm	MH349894
561-130	6	M12 x 1.5R x 27mm	17mm Hex	-	-	321-601-139
561-132	6	M12 x 1.5R x 30mm	17mm Hex	-	-	321-601-139C
561-133	6	M14 x 1.5R x 31mm	17mm Hex	-	-	431/443-601-139A
561-138		USE 561-129				
561-139	2	M12 x 1.5R x 37mm	14mm	4mm	11mm	-
561-140	1	M12 x 1.5R x 37mm	14.4mm	6.4mm	-	MB057603
561-152	6	M12 x 1.5R x 39mm	19mm Hex	-	-	90304-692-920-921
561-154	1	M12 x 1.5R x 36mm	12mm	10mm	-	90113-SAO-003
561-155	1	M12 x 1.25R x 33mm	12mm	8mm	-	90113-634-003
561-158	2	USE 561-112				
561-166	1	M12 x 1.5R x 32mm	13mm	9mm	-	D5RY-1107C
561-167	6	M12 x 1.5R x 28mm	19mm Hex	-	-	-
561-168	2	M12 x 1.5R x 38mm	13mm	7mm	12mm	E07Z-1107A/C
561-169	2	M12 x 1.5R x 43mm	12.85mm	7.5mm	12.7mm	F0CZ-1107A
561-170	1	M12 x 1.5R x 30mm	14.5mm	8mm	-	-
561-174	2	M12 x 1.25R x 34mm	12.24mm	10mm	13mm	96057612
561-175	2	M12 x 1.25R x 38mm	12.24mm	10mm	14mm	96057613
561-212	2	M12 x 1.5R x 44mm	14.5mm	5mm	10mm	-
561-247	2	M12 x 1.5R x 46mm	13.41mm	6.5mm	11.2mm	F0DZ-1107A
561-248	3	M12 x 1.5R x 43mm	14.5mm	6mm	11mm	E43Z-1107A
561-249	2	M12 x 1.5R x 46mm	15.37mm	7mm	15mm	E9SZ-1107C
561-250	3	M12 x 1.5R x 47mm	13.34mm	6.5mm	14.3mm	E9SZ-1107A
561-251	2	M12 x 1.5R x 51mm	13.5mm	5mm	18mm	E3FZ-1107A
561-255	2	M12 x 1.5R x 52mm	12.9mm	13mm	25.4mm	FB05-26-113A
561-264	2	M12 x 1.5R x 52mm	14.33mm	-	25.12mm	90942-02053/044
561-309	2	M12 x 1.5R x 42mm	13.08mm	-	18.03mm	8596-33-062
561-312	2	M12 x 1.5R x 44mm	14.17mm	-	12.70mm	MB584750
561-322	2	M12 x 1.25R x 30mm	14.27mm	-	6.10mm	-
561-361	2	M12 x 1.5R x 41mm	16.50mm	-	12.60mm	6501268, 6501512
561-369	2	M12 x 1.5R x 46mm	15.00mm	-	18.00mm	6502311
561-370	2	M12 x 1.5R x 44mm	15.80mm	-	16.40mm	6502247
561-371	2	M12 x 1.5R x 43mm	17.00mm	-	15.00mm	6502330
561-376	2	M12 x 1.5R x 49mm	13.90mm	-	15.00mm	F3DZ-1107A
561-380	1	M10 x 1.5R x 29mm	10mm	9mm	-	96055156
561-410	2	M14 x 1.5R x 49mm	15.7mm	9mm	14mm	12338057
561-411	2	M14 x 1.5R x 76mm	15.7mm	23mm	27mm	15545356
561-413	2	M14 x 1.5R x 43mm	15.7mm	4mm	6mm	12338040
561-414	2	M14 x 1.5R x 43mm	15.7mm	8mm	14mm	15589423
561-415	2	M14 x 1.5R x 46mm	15.8mm	7mm	14mm	15589455
561-417	4	M14 x 1.5R x 54mm	15.7mm	7mm	19mm	15589486
561-418	2	M14 x 1.5R x 91mm	15.7mm	22mm	33mm	15589493

For applications of 'Papco' Wheel Parts and newest updates, please see current Wheel Parts catalogue/application guide.



562
Series



CARDED WHEEL NUTS
ECROUS DE ROUE SUR CARTE

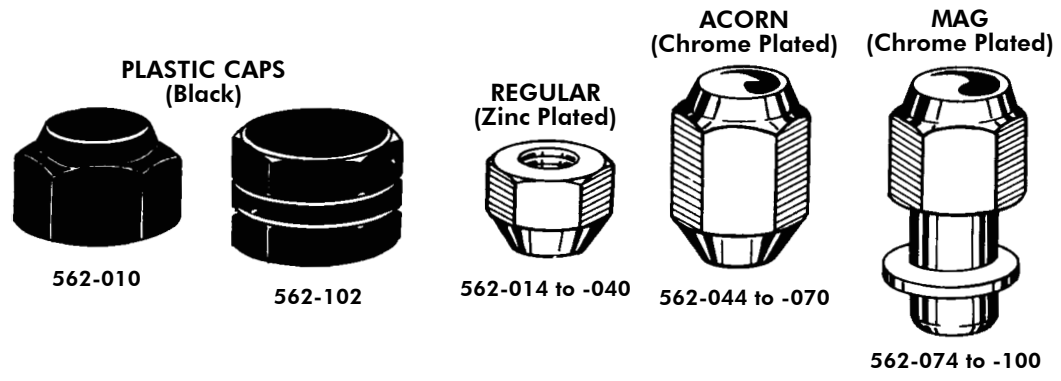

Inch Nuts and Caps packed 5 pcs. per card
Metric Nuts packed 4 pcs. per card

Order by Stock Number

Card No.	Cat. No.	Size	Type	Application	Card No.	Cat. No.	Size	Type	Application
562-010		Fits 13/16 Ford Nuts	Cap	Ford	562-063	(559-163)	M12 x 1.5R	Reg.	Chrysler, Imports
562-012		Fits 3/4 Chrys. Nuts	Cap	Chrysler, GMC	562-064	(559-064)	M12 x 1.25R	Reg.	Imports
562-014	(558-014)	7/16-20R	Reg.	Chrysler, GMC	562-065	(559-065)	M12 x 1.25R	Acorn	Datsun
562-016	(558-016)	1/2-20R	Reg.	AMC, Ford, GMC	562-070	(559-070)	M12 x 1.5R	Acorn	All
562-027	(558-027)	1/2-20R	Reg.	Chrysler	562-072	(559-172)	M12 x 1.5R	Reg.	Ford, Imports
562-035	(559-125)	M12 x 1.25R	Reg.	Datsun	562-074	(558-174)	7/16-20R	Mag	Chrysler, GMC
562-040	(559-150)	M12 x 1.5R	Reg.	All	562-076	(558-176)	1/2-20R	Acorn	AMC, Ford, GMC
562-044*	(558-144)	7/16-20R	Acorn	Chrysler, GMC	562-077	(559-077)	M12x1.5R	Mag	Imports
562-045**	(558-140)	7/16-20R	Acorn	GMC	562-095	(559-095)	M12 x 1.25R	Mag	Datsun
562-046	(558-146)	1/2-20R	Acorn	AMC, Ford, GMC	562-100	(559-100)	M12 x 1.5R	Mag	All
562-048	(558-148)	1/2-20R	Acorn	AMC, Ford, GMC	562-154	(559-154)	M14 x 1.5R	Reg.	GM
562-060	(559-060)	M10 x 1.25R	Acorn	Geo, GMC					

*13/16 AF Nuts; **3/4 AF Nuts

Papco **CARDED WHEEL PARTS KITS**
PRESENTOÚS DE PIÈCES DE ROUE SUR CARTE

'Papco' Wheel Parts Kits provide 95% coverage of today's car and truck applications. Each Kit includes one Wheel Bolt and Nut skin-packed on an attractive, three colour, point-of-purchase display card. Each card features easy to follow installation instructions, application and illustration - plus a price code system for faster check-out service.



Card No.	Cat. No.	Size	Application	Card No.	Cat. No.	Size	Application
562-018	(560-018)	1/2-20R x 1-7/16	Trailer Bolt (2/card)	562-273	(560-173)	1/2-20R x 1-3/4	Ford & Truck
562-019	(560-019)	9/16-18R x 1-7/16	Trailer Bolt (2/card)	562-274	(561-174)	M12 x 1.25R x 34mm	Geo, Suzuki Truck
562-114	(560-114)	7/16-20R x 1-1/2	GMC & Truck, Jeep	562-302	(561-102)	M12 x 1.25R x 39mm	Datsun/ Nissan
562-126	(560-386)	7/16-20R x 1-5/16	GMC & Truck	562-306	(561-106)	M12 x 1.5R x 38.5mm	Chrysler, Renault
562-138	(560-138)	1/2-20R x 1-5/8	GMC & Truck	562-308	(561-108)	M12 x 1.5R x 38.5mm	GMC, Chrysler, Dodge
562-155*	(560-155)	1/2-20R x 1-5/8	GMC & Truck	562-309	(561-109)	M12 x 1.5R x 40mm	Chrysler, Dodge Truck
562-156**	(560-155)	1/2-20R x 1-5/8	Chrysler	562-310	(561-110)	M12 x 1.5R x 43mm	GMC & Truck
562-171	(560-034)	1/2-20R x 1-1/2	GMC, Ford, International	562-311	(561-111)	M12 x 1.5R x 39mm	GMC & Truck
562-172	(560-102)	1/2-20R x 1-5/8	AMC, Dodge Truck, Ford	562-312	(561-212)	M12 x 1.5R x 44mm	Ford
562-173	(560-103)	1/2-20R x 1-1/2	Chrysler, Dodge Truck	562-322	(561-122)	M12 x 1.5R x 36mm	GMC, Toyota
562-175	(560-105)	1/2-20R x 1-13/16	AMC, Chrysler, Dodge	562-329	(561-129)	M12 x 1.5R x 42mm	Chrysler, Imports
562-200	(561-100)	M12 x 1.25R x 39mm	Nissan Truck	562-339	(561-139)	M12 x 1.5R x 37mm	GMC
562-201	(561-100)	M12 x 1.25R x 39mm	Nissan	562-348	(561-248)	M12 x 1.5R x 43mm	Ford
562-204	(560-604)	7/16-20R x 1-3/4	GMC Truck, Jeep	562-351	(561-251)	M12 x 1.5R x 51mm	Ford
562-206	(561-106)	M12 x 1.5R x 38.5mm	Dodge, Chrysler	562-354	(561-154)	M12 x 1.5R x 36mm	Honda
562-208	(561-108)	M12 x 1.5R x 38.5mm	Dodge, Chrysler Truck	562-366	(561-169)	M12 x 1.5R x 43mm	Ford, Mazda
562-209	(561-109)	M12 x 1.5R x 40mm	Chrysler	562-367	(560-367)	1/2-20R x 2	Ford, Mercury
562-210**	(560-110)	1/2-20R x 2	Chrysler, Dodge Truck	562-368	(561-168)	M12 x 1.5R x 38mm	Ford, Mazda
562-211	(560-110)	1/2-20R x 2	Ford	562-369	(560-269)	1/2-20R x 2-1/8	Ford Truck
562-215	(560-315)	1/2-20R x 1-9/16	Ford Truck	562-386	(560-186)	1/2-20R x 1-7/8	Ford Truck
562-220	(561-120)	M12 x 1.5R x 45mm	Toyota Truck	562-409	(561-309)	M12 x 1.5 x 42mm	Mazda Truck
562-226	(561-126)	M12 x 1.5R x 41mm	Geo, Toyota Truck	562-415	(560-315)	1/2-20R x 1-9/16	Ford Truck
562-240	(561-140)	M12 x 1.5R x 37mm	Chrysler Imports	562-422	(561-322)	M12 x 1.25 x 30mm	Subaru
562-248	(560-148)	1/2-20R x 1-13/16	AMC, Ford, GMC, Intern.	562-461	(561-361)	M12 x 1.5 x 41mm	Chrysler
562-267	(560-167)	1/2-20R x 1-15/16	Ford	562-476	(561-376)	M12 x 1.5 x 49mm	Ford, Mercury
562-272	(560-172)	1/2-20R x 1-7/8	Ford & Truck	562-480	(561-380)	M12 x 1.25 x 29mm	GM, Geo

*13/16 AF Nuts; **3/4 AF Nuts

For applications of 'Papco' Wheel Parts and newest updates, please see current Wheel Parts catalogue/application





papco WHEEL PARTS MERCHANDISERS ASSORTIMENTS DE PIÈCES DE ROUE SUR CARTE

'Papco' Wheel Parts are merchandised on three easy to stock, space-saving display racks designed for countertop, pegboard wall, gondola or pylon displays. Modular, metal display rack measures 16" x 24" and features a bilingual, reversible header sign, 20 safety hooks, inventory control system and a planogram for product layout. Merchandisers No. 022-144 and 145 include a 40 card starter stock and merchandiser No. 022-146 includes a 20 card starter stock. Bonus cards are included with each merchandiser to offset the cost of the rack.

- 95% vehicle coverage
- Modular self-serve displays
- Inventory control system
- Applications on each card



GM and IMPORTS WHEEL PARTS MERCHANDISER No. 022-144

Card No.	Cat. No.	Description	Card No.	Cat. No.	Description
562-018	(560-018)	Trailer Bolts (2/card)	562-226	(561-126)	Geo, Toyota
562-019	(560-019)	Trailer Bolts (2/card)	562-274	(561-174)	Geo, Suzuki
562-114	(560-114)	GM & Truck, Jeep	562-308	(561-108)	GM
562-126	(560-386)	GM & Truck	562-310	(561-110)	GM & Truck
562-138	(560-138)	GM & Truck	562-311	(561-111)	GM & Truck
562-155	(560-155)	GM & Truck	562-322	(561-122)	Toyota
562-200	(561-100)	Datsun / Nissan & Truck	562-339	(561-139)	GM
562-201	(561-100)	Datsun / Nissan & Truck	562-354	(561-154)	Honda
562-204	(560-604)	GM & Truck Jeep	562-422	(561-322)	Subaru
562-220	(561-120)	Toyota	562-480	(561-380)	Geo, GM

CHRYSLER and FORD WHEEL PARTS MERCHANDISER No. 022-145

Card No.	Cat. No.	Description	Card No.	Cat. No.	Description
562-173	(560-103)	Chrysler, Dodge & Truck	562-351	(561-251)	Ford
562-206	(561-106)	Chrysler, Dodge	562-366	(561-169)	Ford
562-208	(561-108)	Chrysler, Dodge & Truck	562-367	(560-367)	Ford
562-209	(561-109)	Chrysler, Dodge & Truck	562-368	(561-168)	Ford
562-240	(561-140)	Chrysler Imports	562-369	(560-269)	Ford & Truck
562-272	(560-172)	Ford & Truck	562-386	(560-186)	Ford & Truck
562-273	(560-173)	Ford & Truck	562-409	(561-309)	Mazda
562-312	(561-212)	Ford	562-415	(560-315)	Ford & Truck
562-329	(561-129)	Chrysler Imports	562-461	(561-361)	Chrysler
562-348	(561-248)	Ford	562-476	(561-376)	Ford

WHEEL NUTS MERCHANDISER No. 022-146

Card No.	Cat. No.	Description	Type	Card No.	Cat. No.	Description	Type
562-010		For 13/16AF Nuts	Caps	562-063	(559-163)	M12 x 1.5R Chrysler Imports	Reg.
562-012		For 3/4AF Nuts	Caps	562-064	(559-064)	M12 x 1.25R Imports	Reg.
562-014	(558-014)	7/16-20R Chrysler, GM	Reg.	562-065	(559-065)	M12 x 1.25R Datsun/Nissan	Acorn
562-016	(558-016)	1/2-20R AMC, Ford, GM	Reg.	562-072	(559-172)	M12 x 1.5R Ford, Imports	Reg.
562-027	(558-027)	1/2-20R Chrysler	Reg.	562-074	(558-174)	7/16-20R Chrysler, GM	Mag
562-040	(559-150)	M12 x 1.5R All	Reg.	562-076	(558-176)	1/2-20R AMC, Ford, GM	Mag
562-044	(558-144)	7/16-20R Chrysler, GM	Acorn	562-077	(559-077)	M12 x 1.5R Imports	Acorn
562-045	(558-140)	7/16-20R GM	Acorn	562-095	(559-095)	M12 x 1.25R Datsun/Nissan	Mag
562-048	(558-148)	1/2-20R AMC, Ford, GM	Acorn	562-100	(559-100)	M12 x 1.5R All	Mag
562-060	(559-060)	M10 x 1.25 Geo, GM	Acorn	562-154	(559-154)	M14 x 1.5R GM	Reg.



WHEEL BOLT and NUT ASSORTMENTS ASSORTIMENTS DE BOULON et ECROUS DE ROUE



MERCHANDISER NO. 022-056

'Papco' 'Mega-Paks' are uniformly priced packages of the most popular inch & metric Wheel Bolts and Nuts. Each 'Mega-Pak' features an illustrated, colour coded label, suggested selling price and a double strength drawer box. 'Papco' 'Mega-Paks' are available individually or in a factory prepared Merchandiser No. 022-056 containing 35 sizes of the fastest selling sizes of GM, Ford, Chrysler and Import Wheel Parts.

- Sturdy, Heavy Gauge, Reinforced Steel Cabinet
- Use on Work Bench or Hang on Wall
- Colourful-Durable-Efficient
- Includes Handy Bolt Measuring Gauge



18-1/2" wide
14-3/4" high

WHEEL PARTS MERCHANDISER No. 022-056

Part No.	Cat. No.	Pcs.	Part No.	Cat. No.	Pcs.	Part No.	Cat. No.	Pcs.	Part No.	Cat. No.	Pcs.
025-714	(558-014)	8	025-777	(559-077)	4	025-829	(561-129)	4	025-904	(560-604)	3
025-716	(558-016)	6	025-800	(558-100)	3	025-838	(560-138)	4	025-945	(561-248)	4
025-718	(560-018)	3	025-803	(560-103)	4	025-848	(560-148)	4	025-948	(558-148)	4
025-727	(558-027)	6	025-808	(561-108)	3	025-850	(559-150)	7	025-950	(561-250)	3
025-734	(560-034)	4	025-809	(561-109)	4	025-854	(561-154)	3	025-955	(560-355)	2
025-744	(558-057)	2	025-810	(561-110)	5	025-855	(560-155)	5	025-961	(560-461)	2
025-747	(558-047)	3	025-811	(561-111)	5	025-863	(559-163)	2	025-972	(559-172)	4
025-760	(559-060)	5	025-814	(560-114)	4	025-872	(560-172)	2	025-986	(560-386)	4
025-764	(559-064)	4	025-825	(559-125)	4	025-873	(560-173)	2			



12" w. x 18" l. x 3" d.
020-802



9-3/4" w. x 13-3/4" l. x 2" d.
020-658



020-311

A 'Super-Service' Assortment containing 32 sizes of the most popular Wheel Bolts and Nuts for GM, Ford, Chrysler, AMC and Imports.

A Master Assortment containing 20 sizes of the most popular Wheel Bolts and Nuts for GM, Ford, Chrysler, AMC and Imports.

This Utility Assortment contains 8 sizes of the fastest moving 'Papco' Wheel Nuts.

CONTENTS OF THE ASSORTMENT No. 020-802						CONTENTS OF THE ASSORTMENT No. 020-658						CONTENTS OF THE ASSORTMENT No. 020-311					
Part No.	Pcs.	Part No.	Pcs.	Part No.	Pcs.	Part No.	Pcs.	Part No.	Pcs.	Part No.	Pcs.	Part No.	Pcs.	Part No.	Pcs.		
560-102	5	560-604	5	561-166	5	560-103	5	560-173	5	561-248	5	558-014	5	558-044	5		
560-103	5	561-100	5	561-167	5	560-114	5	560-386	5	561-251	5	558-016	5	558-047	5		
560-105	5	561-102	5	561-248	5	560-138	5	561-108	5	558-014	10	558-027	5	558-100	5		
560-114	5	561-106	5	561-212	5	560-148	5	561-109	5	558-016	10						
560-138	5	561-108	5	561-251	5	560-155	5	561-110	10	558-027	10						
560-148	5	561-109	5	558-014	10	560-167	5	561-129	5	559-150	10						
560-155	5	561-110	5	558-016	10	560-172	5	561-212	5								
560-167	5	561-111	5	558-027	10												
560-172	5	561-120	5	559-125	5												
560-173	5	561-129	5	559-150	10												
506-386	5	561-154	5														



566
Series

papco

SPINDLE and AXLE NUTS
ECROUS D'ESSIEU et FUSSEE

New Axle or Spindle Nuts are recommended whenever a wheel hub, rotor, drum or CV joint is removed. Since the spindle or axle nut is relied upon to hold the wheel on the vehicle these fasteners should be replaced each time for safety.

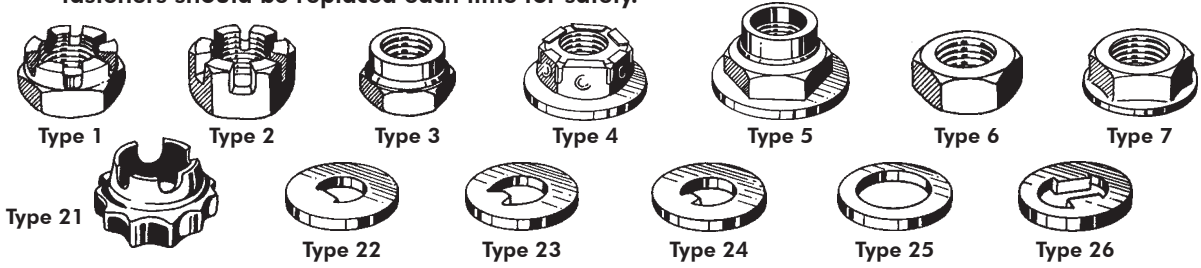

Order by Stock Number

Stock No.	Type	Size	Hex Size	Height	Application	Std. Pkg.
566-057	1	27/32-20	1-1/4	13/16	Corvette, GMC Truck	5
566-065	2	3/4-20	1-1/16	1/2	Buick, Cadillac, Chev, GMC, Olds, Pontiac	5
566-072	6	3/4-16	1-1/16	3/8	AMC, Chrysler, Ford	5
566-074	6	13/16-20	1-1/8	3/8	AMC, Ford, Lincoln, Mercury	5
566-101	6	20mm x 1.5	30mm	8mm	Ford, Lincoln, Mercury	5
566-079	6	22mm x 1.5	32mm	18mm	Chrysler, Nissan	5
566-113	6	24mm x 1.5	35mm	18mm	Nissan	5
566-089	3	20mm x 1.5	29mm	19mm	Buick, Cadillac, Chev, Ford, Lincoln, Mazda, Olds, Pont.	5
566-095	3	24mm x 2.0	36mm	21mm	Buick, Cadillac, Chev, Olds, Pontiac	5
566-094	4	20mm x 1.5	30mm	18mm	Ford Escort, Tempo, Mercury Lynx, Topaz	5
566-099	4	24mm x 2.0	36mm	20mm	Ford, Lincoln, Mercury	5
566-145	5	20mm x 1.5	29mm	23mm	Ford Aspire, Festiva, Geo, Mazda	2
566-097	5	22mm x 1.5	32mm	21mm	Acura, Ford, Honda, Isuzu, Mazda, Mercury, Subaru	5
566-110	5	24mm x 1.5	36mm	23mm	Acura, Honda	2
566-146	5	26mm x 1.5	36mm	23mm	Acura Legend, TL, Vigor	2
566-144	7	27mm x 2.0	34mm	18mm	Buick, Chev, Olds, Pontiac	2
566-073	21	N/A			Retainer for 566-072	5
566-075	21	N/A			Retainer for 566-074	5
566-080	21	N/A			Retainer for 566-079	5
566-102	21	N/A			Retainer for 566-101	5
566-149	21	N/A			Retainer for 566-113	2
Stock No.	Type	I.D.	O.D.	Thick	Application	Std. Pkg.
566-219	22	3/4	1-21/32	3/32	Use with 566-072	5
566-212	23	27/32	1-21/32	7/64	Use with 566-057	5
566-207	23	27/32	2-1/16	11/64	Use with 566-065, 566-057	5
566-229	23	20.1mm	41.8mm	3.0mm	Use with 566-101	5
566-205	24	3/4	1-21/32	3/32	Use with 566-065, 566-072	5
566-234	24	23.5mm	46.9mm	4.6mm	Use with 566-097	5
566-226	25	20.2mm	39.8mm	4.1mm	Use with 566-089	5
566-215	25	21.5mm	36.0mm	3.7mm	Use with 566-089	5
566-227	25	24.7mm	45.1mm	4.7mm	Use with 566-095	5
566-228	25	24.9mm	49.0mm	6.1mm	Use with 566-095	5
566-233	26	3/4	1-21/32	3/32	Use with 566-072	5

For Applications of 'Papco' Spindle and Axle Nuts see current Wheel Parts catalogue.

papco WHEEL HUB DUST CAPS

'Papco' Wheel Hub Dust Caps prolong bearing life by preventing road grime, dust, dirt, or road salt from entering the wheel bearing.

Order by Stock Number

Individually Carded



Stock No.	O.D.	Description
566-301	1-25/32	GM, Ford, Chrysler, Honda, Nissan, AMC
566-302	2-3/32	General Motors
566-303	1-31/32	Ford Pickups and Vans with light duty brakes



569
Series

papco WIRING TERMINALS
COSSE SANS SOUDRE

INSULATED SOLDERLESS TYPE

'Papco' Wiring Terminals are constructed from pure electrolytic copper, annealed and electro-tin plated. The one-piece construction provides a terminal of maximum strength and electrical conductivity. The electro-tin plating affords maximum protection against corrosion. Funnel barrel entry assures easy wire insertion and a positive, solid crimp.

Insulation is colour coded for the appropriate wire gauge: Red 22-18, Blue 18-14 and Yellow 12-10.

22-18 WIRE GAUGE CAL DU FIL			
Stock No.	Type	Stud Size	Pcs. Per Box
569-415	RING	#4-#6	50
569-420	RING	#8-#10	50
569-421	RING	#12-#14	50
569-422	MULTI FIT	#6-#10	50
569-424	HOOK	#8-#10	50
569-425	SPADE	#4-#6	50
569-426	SPADE	#8-#10	50
569-432	BUTT	-	50
569-435	INSUL. QUICK DISC.	1/4 F	25
569-436	INSUL. QUICK DISC.	1/4 M	25
18-14 WIRE GAUGE CAL DU FIL			
569-460	RING	#4-#6	50
569-461	RING	#8-#10	50
569-462	RING	#12-1/4	50
569-464	MULTI FIT	#6-#10	50

18-14 WIRE GAUGE CAL DU FIL			
Stock No.	Type	Stud Size	Pcs. Per Box
569-465	HOOK	#8-#10	50
569-466	SPADE	#4-#6	50
569-467	SPADE	#8-#10	50
569-468	'SNAP' SPADE	#8	50
569-469	'SNAP' SPADE	#10	50
569-470	THREE WAY	-	25
569-473	BUTT	-	50
569-474	QUICK DISC.	1/4 F	50
569-475	QUICK DISC.	1/4 M	50
569-476	INSUL. QUICK DISC.	1/4 F	25
569-477	INSUL. QUICK DISC.	1/4 M	25
569-478	BULLET	-	50
569-500	'SPEE-DEE' CONNECTOR	Make safe, fast, dependable connections. No wire stripping - no cutting - works on 14-18 wire gauge. Use standard pliers. The snap cover gives a completely insulated connection. Polypropylene case maintains live action. 25 pcs.	

18-14 WIRE GAUGE CAL DU FIL			
Stock No.	Type	Stud Size	Pcs. Per Box
569-525	8-478 RECER	-	25
12-10 WIRE GAUGE CAL DU FIL			
569-511	RING	#8-#10	50
569-512	RING	#12-#14	50
569-513	RING	5/16-3/8	50
569-531	MULTI FIT	#6-#10	25
569-516	SPADE	#8-#10	50
569-522	BUTT	-	50
569-523	INSUL. QUICK DISC.	1/4 F	25
569-524	INSUL. QUICK DISC.	1/4 M	25
569-529	CLOSED END	-	50
569-530	'T-TAP' CONNECTORS	Use in trunk to trailer hook-ups. T-splice stop lights and turn signals without stripping wires. Snap plug allows easy disconnect. 25 pcs.	

For other assortments of 'Papco' Wiring Terminals and Crimping Tools see next page.

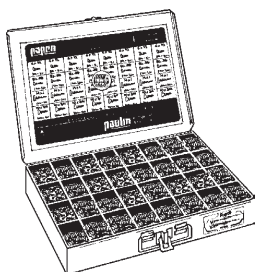

papco SUPER SERVICE ASSORTMENT No. 020-812

Contains 500 Wiring Terminals - complete coverage of all sizes listed. Large size, rigid metal box with high-strength plastic compartments.

For more details see page 9.

Large size: 12" w. x 18" l. x 3" d.



papco® WIRING TERMINALS COSSE SANS SOUDRE



GARAGE ASSORTMENT No. 020-067

Contains 45 Ring, Spade, Multi-Fit and Butt Terminals.
15 sizes packed in a rigid, transparent plastic box.

MASTER ASSORTMENT No. 020-650

This assortment contains 32 items for a total of 325 pieces of the most popular Ring, Spade, Hook, Butt and Quick Disconnect Terminals. Metal box with moulded plastic compartments features grease resistant lid label with actual size illustrations a handy wire size and stud size chart.

Size: 9-3/4" w. x 13-3/4" l. x 2" d.



CRIMPING TOOL OUTIL COSSE

No. 569-300

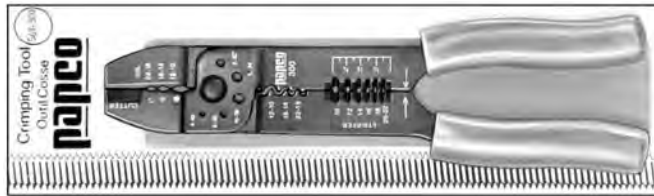

Five in one 'Papco' Crimping Tool is capable of performing five operations: Crimper (both insulated and non-insulated), Wire Cutter, Wire Stripper and Bolt Cutter. Individually carded.

Order by Card No. 569-300

569
Series



CABLE TIES SANGLES POUR CABLE



Standard Type



Mounting Type

Self-locking Nylon ties for quick, simple bundling and mounting. Material is High Strength Black Nylon 6/6 for increased resistance to outdoor exposure and ultra-violet light. Use to secure wiring harness, cables, hose, wires and pipes, and to prevent damage from moving parts or hot engine components. Packed in handy, sealed poly-bags in quantities shown.

Order by Stock Number

Stock No.	Bundle Dia.	Length	Tensile Strength	Std. Pkg.
STANDARD TIES				
569-701	3/4"	4"	18 lbs.	100
569-704	1-1/4"	5-1/2"	40 lbs.	100
569-706	2"	8"	50 lbs.	100
569-708	4"	14-1/2"	50 lbs.	10
569-710	4"	14-1/2"	120 lbs.	10
MOUNTING TIES				
569-714	2"	8"	50 lbs.	25

ASSORTMENT No. 569-700

This assortment of 24 popular 8" ties contains 6 each of 4 colours, red, yellow, blue and black. Use to bundle and identify up to 2" diameter wiring, etc. Packed in a clear poly-bag with header label.

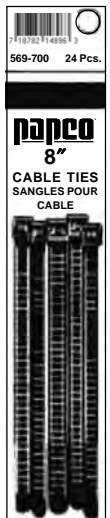

569
Series

papeo

**WIRE GROMMETS
BAGUES POUR FIL**

Oil Resistant Black Vinyl



Prevents insulation damage, shorts and leaks.

Order by Stock Number

Standard Package 10 Pieces

Stock No.	Size	Stock No.	Size
569-232	1/4 O.D. x 1/8 I.D.	569-236	1/2 O.D. x 3/8 I.D.
569-233	5/16 O.D. x 3/16 I.D.	569-238	5/8 O.D. x 1/2 I.D.
569-234	3/8 O.D. x 1/4 I.D.	569-240	7/8 O.D. x 5/8 I.D.

papeo

**FUSE ACCESSORIES
ACCESORIES POUR FUSIBLE**

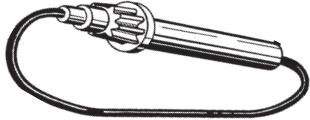

569-029



569-030

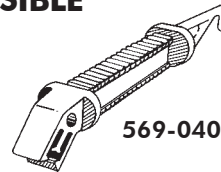

569-040

Order by Stock Number

Standard Package 5 Pieces

Stock No.	Description
569-029	In-line Fuse Holder with 10AMP Fuse, 12ga. wire.
569-030	Blade (ATO) Type Fuse Holder for 3 to 20AMP Fuses.
569-040	Dual Universal Fuse Puller removes and installs glass or blade type fuses.

papeo

**SHRINK TUBING
TUBE RETRAIT**

Order by Stock Number

Stock No.	Size	Std. Pkg.
569-200	3/16 I.D. x 3"	25
569-201	1/4 I.D. x 3"	25
569-203	3/8 I.D. x 3"	25

Insulates, groups and weather proofs wiring connections. Charcoal grey tubing can be cut easily to suit length required. Shrink with warm air blower.

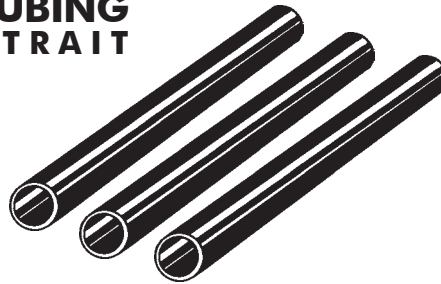

papeo **CIRCUIT TESTERS
VERIFICATEUR DE CIRCUIT**

Tests for voltage presence in circuits. Locates improper connections, shorts and broken wires.

**No. 570-100
6-12 Volts CIRCUIT TESTER**

The most popular and largest selling tester. Quickly and accurately tests all 6 to 12V systems. Includes a spare bulb and extra long 48" lead. Individually carded.

**No. 570-101
HI-LO VOLTAGE CIRCUIT TESTER**

All the proven features of the popular Part No. 570-100 Circuit Tester - plus the ability to test Hi-Voltage circuits such as Spark Plugs. Checks for broken insulators, excessive gap, poor wire, fouled or worn spark plugs.

**No. 570-103
LED DISPLAY AUTO CIRCUIT TESTER**

Professional quality Hi-Lo Voltage Circuit Tester accurately and quickly tests live wires, batteries and ignition systems including Spark Plugs. LED Display on side of tester indicates degree of battery charge. Individually carded.

**No. 570-105
6, 12, 24 Volts CIRCUIT TESTER**

Professional quality tester features unbreakable plastic handle, heavy duty ground clip, 60" long rubber coated, heavy duty lead wire. Tests all 6, 12 and 24 Volts systems with power on. Individually carded.



570-100



570-101

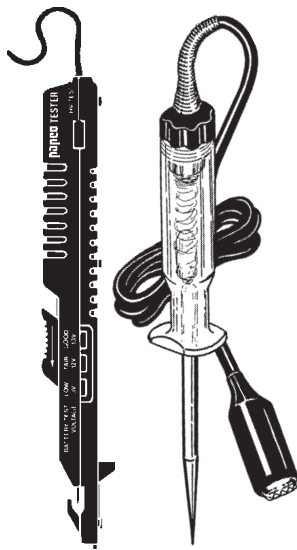

570-103

570-105



570 Series **papeco** **TEST CLIPS**
PINCES DE VERIFIER

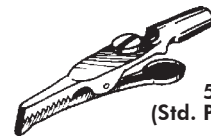

570-129
(Std. Pkg. 10 Clips)

ALLIGATOR TYPE

A handy clip used in test work on ignition, Radio and Electrical applications. Strong, slim jaws with nesting teeth for good contact. Bright plated steel - 2" long - 3/8" jaw spread.

Order by Stock Number 570-129

Standard Package 10 Clips



ASSORTMENT DISPLAY
No. 020-879

Contains 36 Alligator Type Test Clips No. 570-129. Attractive three colour point of purchase display card.

020-879

CARD No. 570-139

Convenient skin-packed card contains four Alligator Type Test Clips. Order by Card No.



Card No. 570-139

papeco **CHARGING CLIPS**
PINCES DE CHARGE

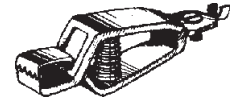

- 'Bull-dog' teeth for positive contact.
- Heavily plated to resist corrosion.
- Feed-thru neck prevents twisting.
- Oversize screw head for easier wiring.

Order by Stock Number

Standard Package 10 Clips

Stock No.	Size	Capacity	Jaw Spread	Length
570-130	Small	10 AMP	1/2"	2"
570-131	Medium	30 AMP	1"	2-7/8"
570-134	Large	50 AMP	1-1/4"	4"



570-110

TEST LEADS
FILS DE VERIFIER

CARD No. 570-110

Electrical test leads for auto, marine, hobby, shop, household and many other applications. Quickly shows hidden trouble in electrical systems. Consists of one black and one red extra long 48" leads complete with insulated, plated steel alligator clips fitted to both ends. Individually packaged.



Convenient skin-packed card contains four Charging Clips. Three sizes available. Order by Card No.

Card No.	Capacity
570-140	10 AMP
570-141	30 AMP
570-144	50 AMP



papeco **BATTERY TERMINAL and GEAR PULLERS**
ARRACHES-COSSES/PIGNONS

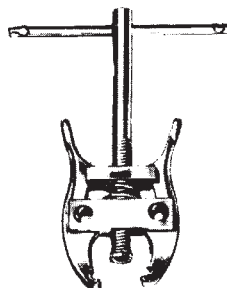

CARD No. 570-260

Use this popular tool to raise the Terminal off the post. A few turns applies even pressure without risk of damage. Individually Carded. Order by Card Number 570-260.

CARD No. 570-264

Professional quality. High-strength arms of drop forged steel. Thin jaws, for battery terminals and gears with small clearance. Pulls gears up to 1-1/2" diameter. Bright Plated. Individually Carded. Order by Card Number 570-264.

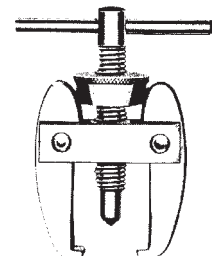

570
Series



papco BATTERY TERMINALS COSSES DE BATTERIE



All 'Papco' Battery Terminals are made of Lead Alloy.

Order by Stock Number

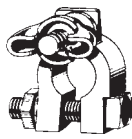
Standard Package 25 terminals.

<p>Stock No. 570-346</p>  <p>UNIVERSAL SIDE MOUNT TERMINAL No. 00 down to No. 6 gauge</p>	<p>Stock No. 570-366</p>  <p>UNIVERSAL MARINE TERMINAL No. 00 down to No. 6 gauge</p>	<p>Stock No. 570-376</p>  <p>UNIVERSAL STRAIGHT TYPE TERMINAL Gauge 0 and 1</p>	<p>Stock No. 570-395</p>  <p>UNIVERSAL TERMINAL No. 00 down to No. 6 gauge</p>
---	---	---	--

020-870

UNIVERSAL BATTERY TERMINAL COSSE DE BATTERIE UNIVERSEL

SOLDERLESS TYPE

**ASSORTMENT
DISPLAY
No. 020-870**

Contains 10 Universal Solderless Battery Terminals No. 570-395 (see above). Attractive three colour display card.

CARD No. 570-396

Universal Solderless Battery Terminal holds No. 00 down to No. 6 gauge. Top plate reverses - holds flat strap or smaller wire. Fits positive or negative posts.



Card No. 570-396

020-868

UNIVERSAL MARINE BATTERY TERMINAL COSSE DE BATTERIE TYPE MARIN UNIVERSEL

SOLDERLESS TYPE

**ASSORTMENT
DISPLAY
No. 020-868**

Contains 10 Universal Marine Type Battery Terminals No. 570-366 (see above). Attractive three colour display card.

CARD No. 570-397

Universal Marine Type Battery Terminal holds No. 00 down to No. 6 gauge. Forged Brass for high conductivity. Heavily plated. Fits positive or negative posts.



Card No. 570-397

020-869

UNIVERSAL SIDE TERMINAL COSSE DE BATTERIE LATERAL UNIVERSEL

SOLDERLESS TYPE

**ASSORTMENT
DISPLAY
No. 020-869**

Contains 8 Universal Side Terminals No. 570-346 (see above). Attractive, three colour point of purchase display card.

CARD No. 570-398

Universal Side Terminals fits both positive and negative posts. Convenient skin-packed card contains two terminals. Order by Card Number.



Card No. 570-398

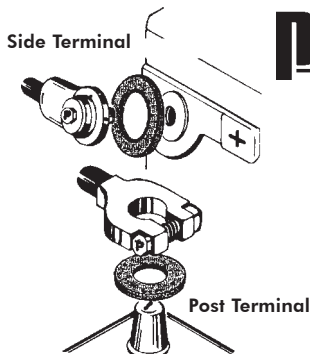

papco BATTERY TERMINAL PROTECTORS PROTECTEURS DE COSSE DE BATTERIE

Special polyester pad impregnated with a chemical corrosion inhibitor that prevents power robbing corrosion build-up. Extends life of terminals and hold downs. Easily installed. Skin-packed two per card.

Order By Card Number

Card No.	Application
570-425	Side Mount Type Battery Terminals
570-426	Post Type Battery Terminals





570 Series

papeco

BATTERY BOOSTER CLAMPS COLLIERS DE CHARGE-BATTERIE



020-889

**ASSORTMENT
DISPLAY
No. 020-889**

Five pair 500 AMP Professional Duty clamps with vinyl insulated, non-slip handles on attractive three colour point of purchase display card. Our finest booster clamp.

500 AMP

**CARD No.
570-245**

500 AMP Professional Duty clamp made of heavy gauge steel, bright nickel plated complete with cable lug. Colour coded vinyl, non-slip insulated handles. Our finest booster clamp. Convenient skin-packed card contains two clamps - one red, one black. Order by Card Number.

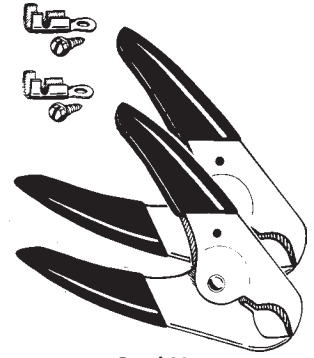

Card No.
570-245



BATTERY TESTER VERIFICATEUR DE BATTERIE

No. 570-250

Tests all 6, 12 and 24 Volt Batteries

Accurately and quickly indicates the degree of charge in each cell. Individually blister-packed. Order by Part Number 570-250

BATTERY BOOSTER ADAPTORS For Side Terminals No. 570-200

Made of copper plated heavy duty steel for maximum conductivity. For use on all side terminal batteries. Installs between the terminal and the battery. Makes an ideal charging connection for hard-to-reach and hard-to-grip side mount terminals.



UNIVERSAL BATTERY and CHARGING POST No. 570-344

For Side Mount Batteries

Use two ways:

- (1) As Charging Post - just screw into side mount battery and attach booster clamps.
- (2) As Battery Post - screw into side mount battery and it becomes a post - attach conventional terminals.

Card No.
570-344

Convenient skin-packed card contains 2 complete charging post.

UNIVERSAL SIDE-MOUNT TERMINAL RATCHET WRENCH No. 570-345

Fits all OEM Side Mount Terminals. Reversible ratchet wrench for easy terminal installation or removal. Also fits most brake bleeder screws. Compact size for easy access.

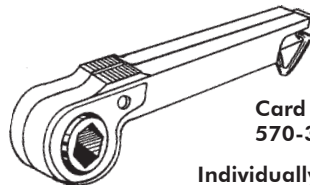

Card No.
570-345

Individually Carded

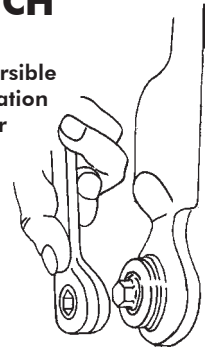

papeco BATTERY POST and TERMINAL CLEANERS NETTOIE-BORNES/ COSSES

No. 570-270

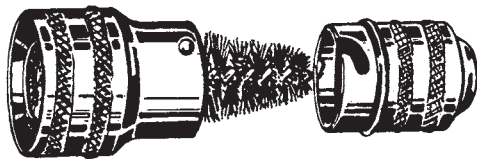

This tool quickly removes corrosion and scale from the terminal. Wire brush in base cleans the battery post. Helps maintain metal-to-metal contact. Individually Carded. Order by Card Number 570-270

No. 570-275

Professional type, heavy duty one piece tool. Quickly and easily removes corrosion and dirt build-up that causes grounding on battery posts and terminals. Specially designed and clearly marked for cleaning either positive or negative posts. Tapered reamer for cleaning all post type battery terminals.



570
Series

papeco

BATTERY HOLD DOWN BOLTS
BOULONS DE FIXE-BATTERIE

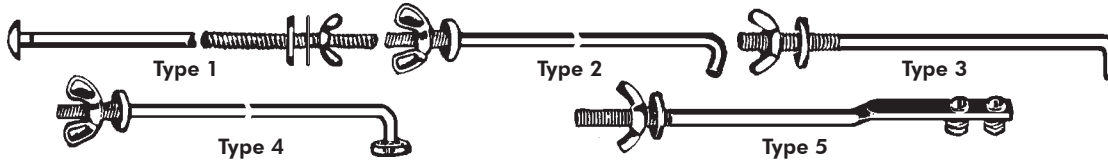

All Bolts are Plated and include Wing Nut and Washer. Convenient skin-packed cards contain two (2) complete Bolts. Order by Card Number.

Card No.	Type	Size	Description	Thread	Application	Factory No.
570-610	2	1/4-20 x 10-1/2	Round Hook	4"	Universal	
570-611	2	1/4-20 x 10	Round Hook	4"	Universal	
570-612	1	5/16-18 x 12	Carr. Head	5-1/2"	Universal	
570-613	2	5/16-18 x 12	Round Hook	5"	Universal	
570-614	3	1/4-20 x 10-1/4	Right Angle	4"	Universal	
570-615	2	5/16-18 x 7-1/2	Round Hook	4"	G.M. Products	3688699
570-616	5	3/8-16 x 6	Flat End with 2 mount. scrs.	2-1/4"	Chrysler Prod. (outer bolt)	
570-617	4	3/8-16 x 10-1/4	Spoke Hook	1-1/2"	Chrysler (inner)	1408918



MASTER ASSORTMENT No. 020-628

- Contains 34 Bolts, 130 pieces. 7 sizes complete with nuts and washers.
- All metal box - hinged lid.
- Handy carrying handle with safety snap lock.
- Illustrated label shows every part.

Garages - Super Service Stations - can replace any Battery Hold Down Bolt with the complete coverage of this assortment.

Metal Merchandiser

UNIVERSAL BATTERY HOLD DOWNS
FIXE-BATTERIE UNIVERSEL

These four styles fit most popular batteries. Made of vinyl coated steel or nylon*, highly resistant to rust and corrosion. Individually skin-packed* on an attractive three colour display card. Order by Card Number. Contains all necessary hardware.

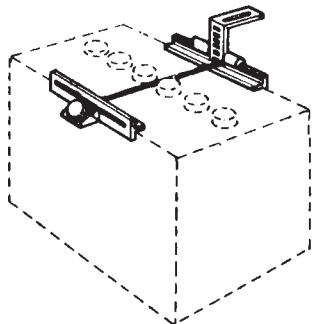

Card No. 570-508
Universal cross bar type fits battery groups 22F, 24, 27, 60.

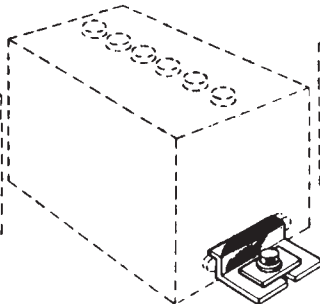

Card No. 570-509
Universal end type for base mount battery groups 22NF, 27F and 29NF.

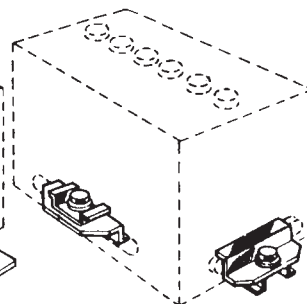

Card No. 570-510
Universal side type for side mount battery groups 22F and 24C also end mount group 22F.

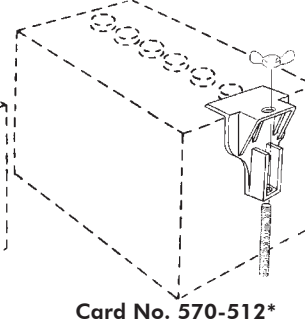

Card No. 570-512*
Contains two Univ. Battery Hold Down clamps. Holds all types of batteries securely. Strong, flexible nylon will not break or corrode.

papeco

BATTERY TERMINAL BOLTS and NUTS
BOULONS et ECROUS POUR COSSE DE BATTERIE

Stock No.
570-410



5/16 x 1-1/4
Bolt and Nut

Standard Package 100 Pieces

Stock No.
570-411



5/16-18
Nut

Stock No.
570-412



5/16 x 1-1/4
Shoulder Bolt
and Nut

Stock No.
570-413



5/16-18
Shoulder
Nut

Stock No.
570-415



3/8 x 7/16
Side Terminal Bolt



5000 Series



18.8 STAINLESS STEEL FASTENERS ATTACHES ACIER INOXYDABLE 18.8

Corrosion resistant Type 300 Series (18% chromium - 8% nickel). Used in Marine applications, food processing equipment and wherever resistance to most acids and chemicals is required. Non-magnetic. UNC thread.

Order by Stock Number



18.8 HEX CAP SCREWS and NUTS



	Dia.	1/4-20	Std. Pkg.	5/16-18	Std. Pkg.	3/8-16	Std. Pkg.	1/2-13	Std. Pkg.
Length	3/4	5000-307	100	5000-442	100	5000-487	100	—	—
	1	5000-309	100	5000-444	100	5000-489	100	5000-579	25
	1-1/2	5000-313	100	5000-448	100	5000-493	100	5000-583	25
	2	5000-316	100	5000-451	100	5000-496	100	5000-586	20
	2-1/2	5000-318	50	5000-453	50	5000-498	50	5000-588	20
	3	5000-320	25	5000-455	25	5000-500	25	5000-590	10
Hex Nuts		5026-014	100	5026-016	100	5026-018	100	5026-022	50



18.8 FLAT WASHERS

Standard Package 100 Pcs., *50 Pcs.

Stock No.	Bolt Size	I.D.	O.D.	Thick.
5055-206	#6	.147	3/8	.031
5055-208	#8	.172	3/8	.031
5055-210	#10	.200	7/16	.037
5055-214	1/4	.265	11/16	.050
5055-216	5/16	11/32	3/4	.050
5055-218	3/8	25/64	7/8	.062
5055-222*	1/2	9/16	1-1/4	.078



18.8 REGULAR LOCK WASHERS

Std. Package 100 Pcs.

Stock No.	Bolt Size
5058-014	1/4
5058-016	5/16
5058-018	3/8
5058-022	1/2



18.8 FINISHING WASHERS

Std. Package 100 Pcs.

Stock No.	Screw Size
5056-971	#6
5056-973	#8
5056-975	#10
5056-979	1/4



18.8 NYLON INSERT LOCK NUTS

Stock No.	Bolt Size	Std. Pkg.
5034-006	6-32	100
5034-008	8-32	100
5034-010	10-24	100
5034-011	10-32	100
5034-014	1/4-20	100
5034-016	5/16-18	100
5034-018	3/8-16	100
5034-022	1/2-13	50

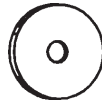

18.8 FENDER WASHERS

Stock No.	Bolt Size	Outside Diameter	Std. Pkg.
5057-394	No. 10	1"	100
5057-395	1/4	1-1/4	100
5057-396	5/16	1-1/2	100
5057-398	3/8	1-1/2	100
5057-400	1/2	2"	50



18.8 STAINLESS COTTER PINS

Stock No.	Size	Std. Pkg.
5080-091	3/32 x 1	100
5080-095	3/32 x 1-1/2	100
5080-141	1/8 x 1	100
5080-145	1/8 x 1-1/2	100
5080-148	1/8 x 2	100
5080-171	5/32 x 1-1/2	100
5080-174	5/32 x 2	100

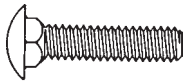

18.8 STAINLESS CARRIAGE BOLTS

Stock No.	Size	Std. Pkg.
5002-309	1/4 x 1	100
5002-313	1/4 x 1-1/2	100
5002-316	1/4 x 2	100
5002-318	1/4 x 2-1/2	50
5002-320	1/4 x 3	50
5002-444	5/16 x 1	50
5002-448	5/16 x 1-1/2	50
5002-451	5/16 x 2	50
5002-453	5/16 x 2-1/2	25
5002-455	5/16 x 3	25
5002-489	3/8 x 1	50
5002-493	3/8 x 1-1/2	50
5002-496	3/8 x 2	25
5002-498	3/8 x 2-1/2	25
5002-500	3/8 x 3	25
5002-504	3/8 x 4	10



18.8 STAINLESS LAG BOLTS

Stock No.	Size	Std. Pkg.
5003-309	1/4 x 1	50
5003-313	1/4 x 1-1/2	50
5003-316	1/4 x 2	50
5003-318	1/4 x 2-1/2	25
5003-320	1/4 x 3	25
5003-448	5/16 x 1-1/2	50
5003-451	5/16 x 2	50
5003-453	5/16 x 2-1/2	25
5003-455	5/16 x 3	25
5003-493	3/8 x 1-1/2	50
5003-496	3/8 x 2	50
5003-498	3/8 x 2-1/2	25
5003-500	3/8 x 3	25
5003-504	3/8 x 4	20
5003-586	1/2 x 2	50
5003-590	1/2 x 3	25
5003-594	1/2 x 4	20



18.8 STAINLESS SOCKET CAP SCREWS

Stock No.	Size	Std. Pkg.
5007-309	1/4 x 1	100
5007-313	1/4 x 1-1/2	100
5007-316	1/4 x 2	100
5007-444	5/16 x 1	100
5007-448	5/16 x 1-1/2	100
5007-451	5/16 x 2	100
5007-453	5/16 x 2-1/2	100
5007-489	3/8 x 1	100
5007-493	3/8 x 1-1/2	100
5007-496	3/8 x 2	50
5007-498	3/8 x 2-1/2	50
5007-500	3/8 x 3	50
5007-579	1/2 x 1	50
5007-583	1/2 x 1-1/2	50
5007-586	1/2 x 2	50
5007-588	1/2 x 2-1/2	25
5007-590	1/2 x 3	25

For a complete listing of non-ferrous and stainless fasteners see separate "Papco" Corrosion Resistant Catalogue.



5000
Series



18.8 STAINLESS STEEL FASTENERS ATTACHES ACIER INOXYDABLE 18.8

18.8 MACHINE SCREWS - PHILLIPS

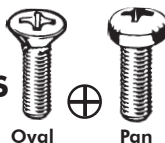

Std. Pkg. 100 Pcs.

Size	Stock No.'s	
	Oval	Pan
6-32 x 1/2	5113-087	5114-087
6-32 x 1	5113-091	5114-091
8-32 x 1	5113-141	5114-141
10-24 x 1	5113-193	5114-193
10-24 x 1-1/2	5113-197	5114-197
10-24 x 2	5113-200	5114-200
1/4-20 x 1-1/2	5113-313	5114-313
1/4-20 x 2	5113-316	5114-316

18.8 FLAT SOCKET TAPPING SCREWS



Std. Pkg. 100 Pcs. Flat Socket

Stock No.	Size
5162-089	6 x 3/4
5162-139	8 x 3/4
5162-141	8 x 1
5162-193	10 x 1
5162-195	10 x 1-1/4
5162-197	10 x 1-1/2
5162-254	12 x 1-1/2

18.8 TAPPING SCREWS TYPE A



Std. Package 100 Pcs. Pan Oval

Size	Stock No.'s	
	Pan	Oval
4 x 1/2	5163-043	5165-043
6 x 3/4	5163-089	5165-089
6 x 1	5163-091	5165-091
8 x 3/4	5163-139	5165-139
8 x 1	5163-141	5165-141
10 x 3/4	5163-191	5165-191
10 x 1	5163-193	5165-193



18.8 HEX MACHINE SCREW NUTS

Size	Stock No.	Std. Pkg.
6-32	5035-006	100
8-32	5035-008	100
10-24	5035-010	100
1/4-20	5035-014	100

For a complete listing of non-ferrous and stainless fasteners see separate 'Papco' Corrosion Resistant Catalogue.



18.8 STAINLESS STEEL THREADED RODS

Standard Package as Required.

Stock No.	Size	Stock No.	Size
5091-310	10-24 x 36"	5091-354	1/4-20 x 72"
5091-314	1/4-20 x 36"	5091-356	5/16-18 x 72"
5091-316	5/16-18 x 36"	5091-358	3/8-16 x 72"
5091-318	3/8-16 x 36"	5091-362	1/2-13 x 72"
5091-322	1/2-13 x 36"	5091-364	5/8-11 x 72"
5091-324	5/8-11 x 36"	5091-366	3/4-10 x 72"
5091-326	3/4-10 x 36"		

Note: Fine Thread 36" long Threaded Rods are available - price on application.

STAINLESS STEEL GARAGE ASSORTMENT

No. 020-212



Contains 110 pieces - 8 sizes of Pan and Oval Socket 18.8 Stainless Steel Tapping Screws and 2 sizes of 18.8 Stainless Finishing Washers packed in a transparent plastic box.

MARINE FASTENER ASSORTMENT

This Master Assortments is ideal for the boat owner for attaching railings, brackets, swivels, posts and other marine equipment and accessories. Each product is fully illustrated on the price coded lid label. Excellent for self-serve sales. Metal box with high strength, moulded plastic compartments and safety locking lid.

MASTER ASSORTMENT

No. 020-673

Contains 20 sizes of Stainless Steel Tapping Screws, Wood Screws, Machine Screws, Nuts and Finishing Washers.



263
Series



MARINE DRAIN PLUGS

BOUCHONS DE VIDANGE TYPE MARIN

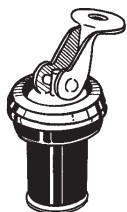

263-652
to
263-660

These reusable expandable neoprene plugs will seal openings during leak testing or painting and can be used as permanent stoppers. Marine applications include boat drain outlet stoppers, bait plugs etc. Plugs are adjustable to control seal pressure as brass cam handle expands rubber body. Metal parts are brass and stainless. Do not use to cap edible products.

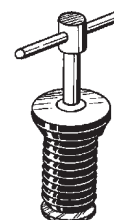

263-650

Order by Stock Number

Standard Package 5 Pieces

Stock No.	Fits Opening I.D.	Description	Stock No.	Fits Opening I.D.	Description
263-650	1"	Tee Handle, 1" long	263-656	5/8"	Cam Handle, 11/16" long
263-652	3/8"	Cam Handle, 11/16" long	263-658	11/16"	Cam Handle, 11/16" long
263-654	1/2"	Cam Handle, 11/16" long	263-660	7/8"	Cam Handle, 11/16" long



PERMA-THREAD® HELICALLY COILED INSERTS PERMA-THREAD® PIÈCES FILETÉES DE RECHANGE

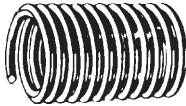

Repair defective, stripped or damaged threads quickly and permanently. These inserts are made of diamond shaped stainless steel wire formed into a spiral screw thread coil.

They form a thread which is stronger than the original tapped material. The resilient quality of the insert allows it to adjust to eliminate stress concentration. The Perma-Thread® insert restores the hole to its initial size - a bolt or screw of the original size can be used for reassembly.

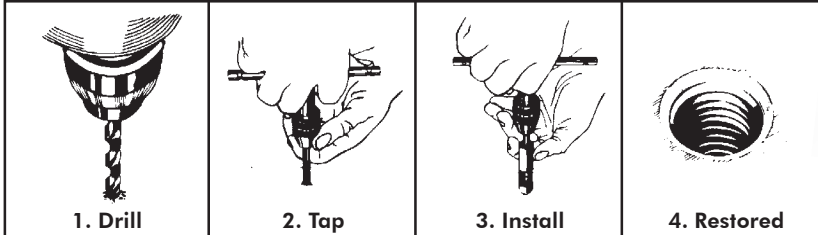

Full instructions for using the Perma-Thread® inserts are provided in each Repair Kit.



THREAD REPAIR MASTER ASST. No. 020-631

Includes contents of one Repair Kit of each 10-24, 1/4-20, 5/16-18, 3/8-16, 7/16-14, 1/2-13 and 14mm with 3/8", 7/16", 1/2" and 3/4" reach.



THREAD REPAIR CENTRE No. 1208-3

Stock the most popular Perma-Thread® inserts on this colourful, metal display. Five complete thread repair kits: 1/4-20, 5/16-18, 3/8-16, 7/16-14, 1/2-13 - plus five packs of inserts. Also one 14mm Spark Plug Kit (Tap and Tool) and three packs of plug inserts. Fourteen items plus rack.

METRIC THREAD REPAIR CENTRE No. 1212-3

Includes 4 Metric thread repair kits: M5x.8, M6x1.0, M8x1.25 and M10x1.5 - plus two Spark Plug Kits (Tap and Tool) for 12mm and 14mm plugs. Also four packs of plug inserts. Fourteen items plus rack.

PERMA-PLUG® 'PERMA-PLUG' SPARK PLUG REPAIR KIT No. 2200-14 TROUSSE DE REPARATION DE BOUGIE 'PERMA-PLUG'

INCLUDES ONE EACH OF THE ITEMS LISTED BELOW

Can be used with M14 x 1.25 taper seat or gasket type Spark Plugs in either aluminum or cast iron. Easily installed without drilling - becomes a permanent repair.



PILOTED TAP

2258-14

Tap

Lubricate tap. Start by hand then use socket to tap hole full depth. Clean chips from hole.



INSERTS

Short 2214-S Normal 2214-N Long 2214-L

Select Insert

Select insert length same as threads on spark plug. Coat outside threads with hi-temp RTV silicone. Knurled end of insert should be at top of hole.



Install

Using spark plug, screw insert in until flush with spark plug hole.



EXPANDING TOOL

2294-14



Repaired

Place tool into insert and strike several times to expand knurl and lock insert. Install plug to recommended torque. Run engine after sealant has set.



PERMA-PLUG
DISPLAY
CENTRE
No. 1400-1

Perma-Plug Display Centre No. 1400-1

Contents and Replacement Parts

Description	Part No.	Qty
M14 x 1.25 Perma-Plug Kit	2200-14	3
M14 x 1.25 x 3/8 Short Reach Insert	2214-S	4
M14 x 1.25 x 1/2 Normal Reach Insert	2214-N	4
M14 x 1.25 x 3/4 Long Reach Insert	2214-L	4



PERMA-THREAD® HELICALLY COILED INSERTS PERMA-THREAD® PIÈCES FILETÉES DE RECHANGE

Repair Kits contain inserts, tap and installation tools. Inserts also available in standard packages.
Order by Stock Number



Repair Kits

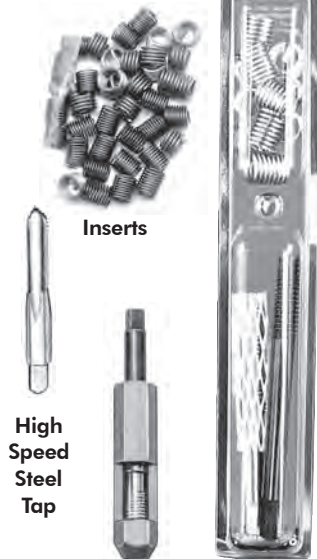

High Speed Steel Tap

Installation Tool

Repair Kits for field or shop use.

Complete Kits: Inserts-taps-tools.

SPARK PLUG SERIES

COMBINATION PILOTED REAMER/TAP

No drilling for spark plug port repair

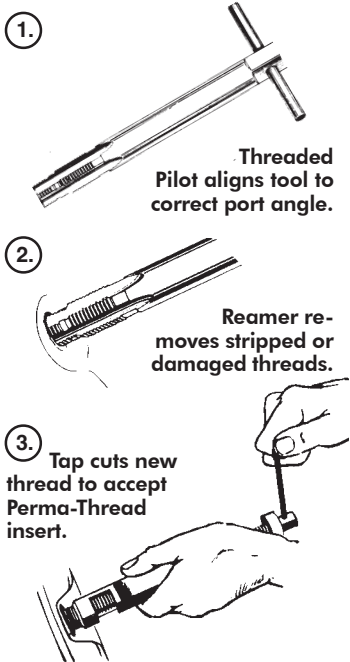

UNIFIED NATIONAL COARSE								
STANDARD PACKAGES					REPAIR KITS		TAPS	TOOLS
Size	Insert Pkg	Drill	Qty.		Kit	Inserts	Tap	Tool
Dia. x Length	Part No.	Size	Per Pack		Part No.	Per Kit	Part No.	Part No.
4-40	.168	P208-014	1/8	12	1208-014	12	1428-014	1182-014
5-40	.188	P208-015	9/64	12	1208-015	12	1428-015	1182-015
6-32	.207	P208-016	5/32	12	1208-016	12	1428-016	1182-016
8-32	.246	P208-018	11/64	12	1208-018	12	1428-018	1182-018
10-24	.285	P208-101	13/64	12	1208-101	12	1428-101	1182-101
12-24	.324	P208-102	15/64	12	1208-102	12	1428-102	1182-102
1/4-20	.375	P208-104	17/64	12	1208-104	12	1428-104	1182-104
5/16-18	.469	P208-105	21/64	12	1208-105	12	1428-105	1182-105
3/8-16	.562	P208-106	25/64	12	1208-106	12	1428-106	1182-106
7/16-14	.656	P208-107	29/64	6	1208-107	6	1428-107	1182-107
1/2-13	.750	P208-108	17/32	6	1208-108	6	1428-108	1182-108
9/16-12	.844	P208-109	19/32	6	1208-109	6	1428-109	1182-109
5/8-11	.938	P208-110	21/32	6	1208-110	6	1428-110	1182-110
3/4-10	1.125	P208-112	25/32	4	1208-112	4	1428-112	1182-112
7/8-9	1.312	P108-114	29/32	1	3208-C14	6	1043-14CP3	1182-114
1-8	1.500	P108-116	1-1/32	1	3208-C16	6	1043-16CP3	1182-116
1-1/8-7	1.688	P108-118	1-5/32	1	3208-C18	5	1043-18CP3	1182-118
1-1/4-7	1.875	P108-120	1-9/32	1	3208-C20	5	1043-20CP3	1182-120
1-3/8-6	2.062	P108-122	1-13/32	1	3208-C22	4	1043-22CP3	1182-122
1-1/2-6	2.250	P108-124	1-17/32	1	3208-C24	4	1043-24CP3	1182-124
UNIFIED NATIONAL FINE								
10-32	.285	P208-201	13/64	12	1208-201	12	1428-201	1172-201
1/4-28	.375	P208-204	17/64	12	1208-204	12	1428-204	1172-204
5/16-24	.469	P208-205	21/64	12	1208-205	12	1428-205	1172-205
3/8-24	.562	P208-206	25/64	12	1208-206	12	1428-206	1172-206
7/16-20	.656	P208-207	29/64	6	1208-207	6	1428-207	1172-207
1/2-20	.750	P208-208	33/64	6	1208-208	6	1428-208	1172-208
9/16-18	.844	P208-209	37/64	6	1208-209	6	1428-209	1172-209
5/8-18	.938	P208-210	41/64	6	1208-210	6	1428-210	1172-210
3/4-16	1.125	P208-212	49/64	4	1208-212	4	1428-212	1172-212
7/8-14	1.312	P108-214	57/64	1	3208-F14	6	1043-14FP3	1039-14F
1-14	1.500	P108-2164	1-1/64	1	3208-F164	6	1043-164FP3	1039-164F
1-1/8-12	1.688	P108-218	1-5/32	1	3208-F18	5	1043-18FP3	1039-18F
1-1/4-12	1.875	P108-220	1-9/32	1	3208-F20	5	1043-20FP3	1039-20F
1-3/8-12	2.062	P108-222	1-13/32	1	3208-F22	4	1043-22FP3	1039-22F
1-1/2-12	2.250	P108-224	1-17/32	1	3208-F24	4	1043-24FP3	1039-24F
STANDARD METRIC SERIES								
					Coarse Thread Series			
M5 x 0.8	7.5mm	P206-305	13/64	12	1221-305	12	1448-305	1287-305
M6 x 1.0	9.0mm	P206-306	1/4	12	1221-306	12	1448-306	1287-306
M7 x 1.0	10.5mm	P206-307	9/32	12	1221-307	12	1448-307	1289-307
M8 x 1.25	12.0mm	P206-308	21/64	12	1221-308	12	1448-308	1289-308
M9 x 1.25	13.5mm	P206-309	m9.4	12	1221-309	12	1448-309	1289-309
M10 x 1.5	15.0mm	P206-310	13/32	12	1221-310	12	1448-310	1289-310
M11 x 1.5	16.5mm	P106-311	29/64	6	1221-311	6	1448-311	1289-311
M12 x 1.7	18.0mm	P106-312	31/64	6	3221-M12C	6	5043-120CP4	1289-312
M14 x 2.0	21.0mm	P106-314	37/64	6	3221-M14C	6	5043-140CP4	1289-314
M16 x 2.0	24.0mm	P106-316	21/32	6	3221-M16C	6	5043-160CP4	1289-316
M18 x 2.5	27.0mm	P106-318	47/64	6	3221-M18C	6	5043-180CP4	1289-318
M20 x 2.5	30.0mm	P106-320	13/16	6	3221-M20C	6	5043-200CP4	1289-320
					Fine Thread Series			
M10 x 1.2	15.0mm	P106-610	13/32	6	3221-M10F	6	5043-100FP4	1287-610
M11 x 1.2	16.5mm	P106-61125	29/64	6	1221-M1125	6	1448-61125	1287-61125
M12 x 1.2	18.0mm	P106-612	31/64	6	3221-M12F	6	5043-120FP4	1287-612
M12 x 1.5	18.0mm	P106-61215	31/64	6	3221-M1215	6	5043-1215P4	1287-61215
M14 x 1.5	21.0mm	P106-614	9/16	6	3221-M14F	6	5043-140FP4	1287-614
M16 x 1.5	24.0mm	P106-616	21/32	6	3221-M16F	6	5043-160FP4	1287-616
SPARK PLUG SERIES								
					DO NOT USE THESE INSERTS TO REPAIR TAPER SEAT SPARK PLUG PORTS.			
M10 x 1.0	.500	P410-500		6	1210-410*	-	1458-100	1094-100
M12 x 1.2	.500	P412-500		6	1212-412*	-	1458-123	1094-123
M12 x 1.2	.750	P412-750		6	-	-	-	-
M14 x 1.2	.375	P414-375		6	1214-414*	-	1458-143	1094-143
M14 x 1.2	.438	P414-438		6	-	-	-	-
M14 x 1.2	.500	P414-500		6	-	-	-	-
M14 x 1.2	.750	P414-750		6	-	-	-	-
M18 x 1.5	.500	P418-500		6	1218-500	6	1458-185	1094-185
'PERMA-PLUG' SPARK PLUG SERIES								
					CAN BE USED WITH TAPER SEAT OR GASKET TYPE SPARK PLUGS.			
M14 x 1.2	.375	2214S		1	-	-	-	-
M14 x 1.2	.500	2214N		1	2200-14	-	2258-14	2294-14
M14 x 1.2	.750	2214L		1	-	-	-	-

* NOTE: 10mm, 12mm and 14mm spark plug kits contain combination piloted Reamer/Tap tool and NO inserts. Same tools are applicable regardless of insert length. Purchase packs of inserts separately. 'Perma-Thread' Repair Kits include: Inserts, Tap, Installation Tool, Instructions unless otherwise specified.



904
Series

Papco VACUUM CONNECTORS RACCORDS DE PLASTIQUE

"Papco" Plastic Fittings are designed for quick, easy, inexpensive installations of vacuum lines, windshield washer lines and any other low pressure systems using air or fluids. Can be used with all flexible plastic tubing. Not recommended for fuel line applications.

Order by Stock Number



Nylon
STRAIGHT CONNECTOR

Part No.	Tube Size	x	Tube Size
904-901	1/8	x	1/8
904-902	3/16	x	3/16
904-903	1/4	x	1/4
904-904	5/16	x	5/16
904-905	3/8	x	3/8



Nylon
REDUCING
STRAIGHT CONNECTOR

Part No.	Tube Size	x	Tube Size
904-911	1/8	x	3/16
904-912	1/8	x	1/4
904-913	3/16	x	1/4
904-914	1/4	x	3/8



Nylon
RESTRICTOR CONNECTOR

Part No.	Tube Size	x	Tube Size
904-920	3/16	x	3/16



Nylon
3 WAY TEE

Part No.	Tube Size
904-922	1/8 x 1/8 x 1/8
904-923	3/16 x 3/16 x 3/16
904-924	1/4 x 1/4 x 1/4
904-925	5/16 x 5/16 x 5/16
904-926	3/8 x 3/8 x 3/8

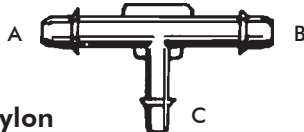

Nylon
3 WAY REDUCING TEE

Part No.	Tube Size 'A' x 'B' x 'C'
904-929	1/8 x 1/8 x 3/16
904-930	1/8 x 1/8 x 1/4
904-931	3/16 x 1/8 x 3/16
904-932	3/16 x 1/4 x 3/16
904-933	3/16 x 3/16 x 1/8
904-934	1/4 x 3/16 x 3/16
904-938*	1/4 x 3/8 x 3/8
904-939	3/8 x 3/8 x 1/4

*PCV Connector



Nylon
'Y' CONNECTOR

Part No.	Tube Size
904-940	1/8 x 1/8 x 1/8
904-941	3/16 x 3/16 x 3/16
904-942	1/4 x 1/4 x 1/4
904-943	5/16 x 5/16 x 5/16

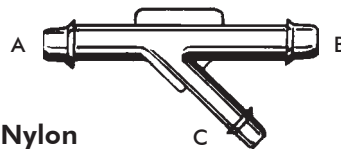

Nylon
REDUCING 'Y' CONNEC-

Part No.	Tube Size 'A' x 'B' x 'C'
904-944	1/4 x 1/4 x 3/16

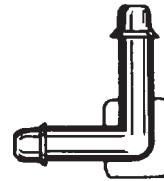

Nylon
90° ELBOW

Part No.	Tube Size	x	Pipe Size
904-950	1/8	x	1/8
904-951	3/16	x	3/16
904-952	1/4	x	1/4
904-953	5/16	x	5/16

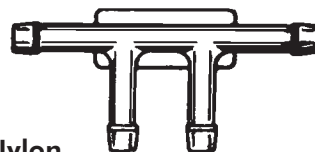

Nylon
FOUR WAY CONNECTOR

Part No.	Tube Size
904-960	3/16



Nylon
FIVE WAY CONNECTOR

Part No.	Tube Size
904-965	3/16

For 'Papco' Vacuum Connectors Master Assortment No. 020-605 see page 6.

Standard Package 25 Pieces

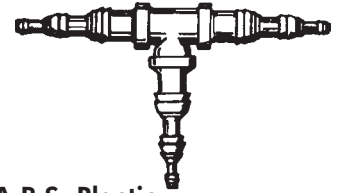

A.B.S. Plastic
UNIVERSAL TEE

Part No.	Tube Size
904-975	5/32 to 1/4 to 3/8



A.B.S. Plastic
UNIVERSAL STRAIGHT
CONNECTOR

Part No.	Tube Size
904-976	5/32 to 1/4 to 3/8



VACUUM CAPS

Part No.	Tube Size
904-990	1/8
904-991	3/16
904-992	1/4
904-993	5/16
904-994	3/8

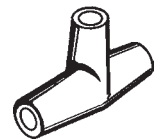

Soft Rubber
VACUUM TEE

Part No.	Hose Size
904-985	7/64 x 7/64 x 7/64

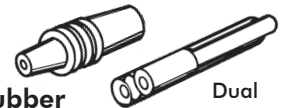

Soft Rubber
VACUUM CONNECTORS

Part No.	Hose Size
904-986	5/32 Dual
904-987	1/8 x 5/32

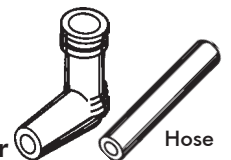

Soft Rubber
VACUUM ELBOW and HOSE

Part No.	Hose Size
904-988	5/32 x 3/16
904-989	5/32 x 2" Hose



papcoflex STEEL BRAKE LINE MERCHANDISERS PRESENTOIRS TUBULURE DE FREIN

"Papcoflex" Steel Brake Line floor merchandisers are available in 3 variations (see below) and may be linked together to form a master warehouse stock to cover almost every brake line requirement. Compact wire rack measures 9-1/2"w. x 20-1/2"d. x 28"h. and includes colour-coded, permanent PVC storage tubes for dispensing lines. Each "Papcoflex" Brake Line is labelled showing part number, O.D. and length - can be shaped by hand without crimping or collapsing.



No. 022-284
Empty Wire Rack
(With tubes and colour-coded labels to create your own mix of lines)

STEEL BRAKE LINE MERCHANDISER No. 022-285

Length	3/16 O.D. Part No.	1/4 O.D. Part No.	5/16 O.D. Part No.	3/8 O.D. Part No.
8"	S308	S408	S508	*S610
12"	S312	S412	S512	S612
20"	S320	S420	S520	S620
30"	S330	S430	S530	S630
40"	S340	S440	S540	S640
51"	S351	S451	S551	S651
60"	S360	S460	S560	S660

Contains 3 each of 28 sizes of "Papcoflex" Brake Lines for a total of 84 lines. Rack and tubes included.

*10" Lines

ARMOURD BRAKE LINE MERCHANDISER No. 022-286

Length	3/16 O.D. Part No.	1/4 O.D. Part No.	5/16 O.D. Part No.	3/8 O.D. Part No.
8"	AS308	AS408	AS508	*AS610
12"	AS312	AS412	AS512	AS612
20"	AS320	AS420	AS520	AS620
30"	AS330	AS430	AS530	AS630
40"	AS340	AS440	AS540	AS640
51"	AS351	AS451	AS551	AS651
60"	AS360	AS460	AS560	AS660

Contains 3 each of 28 sizes of "Papcoflex" Armoured Steel Brake Lines for a total of 84 lines. Rack and tubes included.

*10" Lines

METRIC BRAKE LINE MERCHANDISER No. 022-287

Length	Type A Japanese Part No.	Type B British Part No.	Type C European Part No.
8"	MA308	MB308	MC308
12"	MA312	MB312	MC312
20"	MA320	MB320	MC320
30"	MA330	MB330	MC330
40"	MA340	MB340	MC340
51"	MA351	MB351	MC351
60"	MA360	MB360	MC360

Contains 3 each of 21 sizes of "Papcoflex" Metric Brake Lines for a total of 63 lines. Rack and tubes included.

papcoflex BRAKE LINE MERCHANDISERS

Each merchandiser includes a colourful metal rack with measuring gauge. Can be hung on a wall, shelf end or post. When joining two or more lines use 'Papco' Inverted Flare Unions.

No. 022-080 STEEL BRAKE LINE MERCHANDISERS

Contains 56 lengths of the most popular 3/16" and 1/4" diameter Steel Brake Lines. Four each of 3/16" and 1/4"x 8", 12", 20", 30", 40", 51" and 60".

Contains 48 lengths of the most popular 5/16" and 3/8" diameter Steel Brake Lines. Four each of 5/16" and 3/8"x 12", 20", 30", 40", 51" and 60".

No. 022-081 ARMOURD STEEL BRAKE LINE MERCHANDISERS

Contains 56 lengths of the most popular 3/16" and 1/4" diameter Armoured Brake Lines. Four each of 3/16" and 1/4"x 8", 12", 20", 30", 40", 51" and 60".

Contains 48 lengths of the most popular 5/16" and 3/8" diameter Armoured Brake Lines. Four each of 5/16" and 3/8"x 12", 20", 30", 40", 51" and 60".

METRIC BRAKE LINE MERCHANDISER No. 022-083

Contains 42 lines - two each of the 21 listed lengths of Metric Brake Lines in Type 'A', 'B' and 'C'.

EMPTY BRAKE LINE RACKS

No. 022-077 For 3/16" and 1/4" dia. Brake Lines.
No. 022-078 For 5/16" and 3/8" dia. Brake Lines.
No. 022-078M For 3/16" dia. Metric Brake Lines.





papcoflex

**STEEL HYDRAULIC BRAKE LINES
TUBULURE DE FREIN ACIER**

STEEL BRAKE LINES

These ready to install "Papcoflex" Steel Hydraulic Brake Lines are required by every garage, service station, transmission specialist, fleet and farm equipment dealer. They are ideal replacements for hydraulic, gas, oil and vacuum lines used on all cars, trucks, buses and tractors. "Papcoflex" Lines are made of a single strip of copper coated steel, spiral wound for extra strength. This double-walled tube is then fused thereby providing a solid seamless, easy-to-bend tube. Tin coating is then applied to afford the highest degree of corrosion resistance. Flared fittings are included.



ARMoured STEEL BRAKE LINES

"Papcoflex" Armoured Steel Brake Lines feature the highest degree of protection against common road hazards. Each steel line is wound the entire length with a .046" diameter high carbon, galvanized wire and comes complete with flared fittings. Every line is O.E.M. approved and can be hand shaped to duplicate the original.



METRIC BRAKE LINES

All the proven features of the "Papcoflex" Steel Hydraulic Brake Line. Available in three types, all 3/16" diameter and in popular length as listed.

Type 'A': Metric Thread with standard flare. For Colt, Datsun, Honda, Mazda and Toyota.

Type 'B': U.S. Thread with bubble flare. For Austin, Cortina, Cricket, Fiat, Jaguar, M.G. and Triumph.

Type 'C': Metric Thread with bubble flare. For BMW, Citroen, Mercedes-Benz, Peugeot, Porsche, VW.

Order by Part Number

Standard Package contains 10 Lines

Overall Length	3/16" O.D.		1/4" O.D.		5/16" O.D.		3/8" O.D.		METRIC 3/16" O.D.		
	Steel	Armoured Steel	Steel	Armoured Steel	Steel	Armoured Steel	Steel	Armoured Steel	Type 'A'	Type 'B'	Type 'C'
6"	S306	AS306	-	-	-	-	-	-	-	-	-
8"	S308	AS308	S408	AS408	S508	AS508	-	-	MA308	MB308	MC308
10"	S310	AS310	-	-	S510	AS510	S610	AS610	-	-	-
12"	S312	AS312	S412	AS412	S512	AS512	S612	AS612	MA312	MB312	MC312
20"	S320	AS320	S420	AS420	S520	AS520	S620	AS620	MA320	MB320	MC320
30"	S330	AS330	S430	AS430	S530	AS530	S630	AS630	MA330	MB330	MC330
40"	S340	AS340	S440	AS440	S540	AS540	S640	AS640	MA340	MB340	MC340
51"	S351	AS351	S451	AS451	S551	AS551	S651	AS651	MA351	MB351	MC351
60"	S360	AS360	S460	AS460	S560	AS560	S660	AS660	MA360	MB360	MC360
72"	S372	AS372	S472	AS472	S572	AS572	S672	AS672	-	-	-
108"	-	-	-	-	-	-	S6108	AS6108	-	-	-
Unions	142-3		142-4		142-5		142-6		PC1192	PC1190	PC1191

papco

**STEEL HYDRAULIC BRAKE LINES
TUBULURE DE FREIN ACIER**



ADAPTOR BRAKE LINES

"Papco" Adaptor Brake Lines allow for quick and easy connections of Steel Brake Lines to either the Master Cylinder or the Proportioning Valve. Eliminates having to make up your own lines with adaptors and steel tubing. All adaptor lines are 8" in length.

Order by Part Number

Individually Skin-Packed

Card No.	Description
913-001	1/4" Inverted Brass Plated Nut - GM
913-002	3/16" Inverted 1/4" Inverted Red Nut - AMC, Chrysler, Ford, GM
913-003	3/16" Inverted to 5/16" Inverted Black Nut - Ford
913-004	3/16" Inverted to 5/16" Inverted Green Nut - Ford, GM
913-005	1/4" Inverted to 5/8-18 Blue Nut - GM
913-006	3/16" Inverted to 5/8-18 Olive Nut - Ford

papeo FUEL LINES TUYÈRE D'ESSENCE



'Papco' Fuel Lines are replacements for damaged, crimped or corroded lines from GM tank sending units or lines used with GM Fuel Filter No. 481. All lines come complete with Metric Flare Nut and a fuel rated 'O' Ring that ensures a reliable seal to the GM fuel filter. The 'bubble' end of the line is designed to provide an easy, leak-proof connection to the existing or replacement rubber fuel line. 5/16" lines have a M14x1.5 Nut and 3/8 lines have a M16x1.5 Nut.

Order by Stock Number

Individually Packaged

5/16" Diameter				3/8" Diameter			
Stock No.	Size	Stock No.	Size	Stock No.	Size	Stock No.	Size
905-506	5/16 x 6	905-524	5/16 x 24	905-606	3/8 x 6	905-624	3/8 x 24
905-509	5/16 x 9	905-536	5/16 x 36	905-609	3/8 x 9	905-636	3/8 x 36
905-512	5/16 x 12	905-548	5/16 x 48	905-612	3/8 x 12	905-648	3/8 x 48
905-518	5/16 x 18			905-618	3/8 x 18		

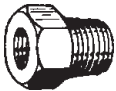

TRANSMISSION FITTINGS and BRAKE LINE ADAPTORS

Stock No.	Inverted Seat	Male Thread
P7818	3/16	1/4 (7/16-14)
P7897	3/16	5/16 (1/2-20)
P7817	3/16	(S)1/2-20*
P7909	3/16	1/2-20*
P7910	3/16	9/16-20*
P7911	3/16	9/16-18*
P7912	3/16 (9/16-18)	1/2-20*
P7913	3/16 (1/2-20)	9/16-18*
P7828	1/4	(S)3/16 (3/8-24)
P7829	1/4	5/16 (1/2-20)
P7908	1/4	9/16-18*
P1074	5/16	(S)1/2-20*

* Special Thread

(S) Sealing Surface on hex face

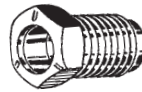

METRIC FLARE NUTS

Stock No.	Size	Std. Pkg.
905-101	M14 x 1.5	5
905-104	M16 x 1.5	5



FOREIGN CAR BRAKE LINE ADAPTORS

Stock No.	Female	Male
PC1176	Tube 3/16	3/16
Standard	Thrd. 3/8-24	10mmx1.0
PC1177	Tube 3/16	3/16
Bubble	Thrd. 3/8-24	3/8-24
PC1178	Tube 3/16	3/16
Bubble	Thrd. 3/8-24	10mmx1.0

INVERTED FLARE UNION

Stock No.	Tube Size
142-3	3/16
142-4	1/4
142-5	5/16
142-6	3/8



METRIC FLARE UNION Bubble Flare - U.S. and Metric Thread

Stock No.	Female Bubble	Female Bubble
PC1190	Tube 3/16 Thrd. 3/8-24	3/16 3/8-24
PC1191	Tube 3/16 10mmx1.0	3/16 10mmx1.0



METRIC FLARE UNION Standard Flare - Metric Thread

Stock No.	Inverted Flare	Inverted Flare
PC1192	Tube 3/16 10mmx1.0	3/16 10mmx1.0



BRAKE LINE FLARE NUTS

Stock No.	Size
MA300	10mmx1.0 SAE Flare
MC300	10mmx1.0 Bubble Flare

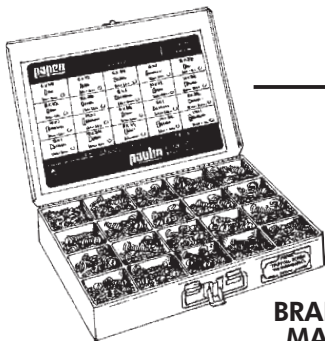

BRAKE BLEEDER SCREW MASTER ASSORTMENT No. 020-604

Contains 63 pieces of all listed Brake Bleeder Screws, Inverted Flare Nuts and Unions as well as Brake Line Adaptors and Metric Brake Line Flare Nuts.

papeo BRAKE BLEEDER SCREWS VIS DE PURGE DES FREINS

'Papco' Brake Bleeder Screws are made of zinc plated steel to resist rust. Replaces corroded, broken or stripped screws. Coverage for most domestic and import vehicles.



Type 1

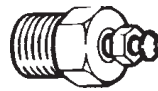

Type 2



Type 3

Order by Stock Number

Standard Package 5 Pieces

Stock No.	Description	Type	Stock No.	Description	Type
904-200	3/8-24 x 1.471 (Ford/Chrysler)	1	904-209	7mm x 1.0 x 32mm (Domestic/Imp.)	1
904-201	10mm x 1.5 x 28mm (GM)	3	904-212	10mm x 1.0 x 33mm (Domestic/Imp.)	1
904-203	3/8-24 x 1.110 (All Domestic)	1	904-213	5/16-24 x 1.060 (GM/Chrysler)	1
904-204	8mm x 1.25 x 33mm (GM/Honda)	3	904-218	Small Repair Insert	2
904-206	1/4-28 x .920 (AMC/Ford/Chrysler)	1	904-219	Large Repair Insert	2



papco® HYDRAULIC GREASE FITTINGS GRAISSEURS HYDRAULIQUES

"Papco" Hydraulic Grease Fittings are manufactured from high-quality, case hardened steel and are Yellow Zinc plated to resist corrosion. Each fitting is heat treated and tested to 8,000 p.s.i. Spring-loaded ball check valve ensures a dirt-free lubrication system. "Papco" Grease Fittings are available in all popular thread types including thread-forming and metric.



Order by Stock Number

Standard Package 25 Pieces

Part No.	Type	Description	Part No.	Type	Description
904-607	7	1/8 NPT Straight Long	904-691	5	1/4-28 90° Elbow
904-610	1	1/8 NPT Straight	904-692	1	5/16-24 Straight
904-611	2	1/8 NPT 30° Elbow	904-693	1	3/8-24 Straight
904-688	3	1/8 NPT 45° Elbow	904-690	6	1/4-28 Thread-Forming
904-612	4	1/8 NPT 65° Elbow	METRIC FITTINGS		
904-613	5	1/8 NPT 90° Elbow	904-701	1	6mm x 1.0 Straight
904-627	1	1/4 NPT Straight	904-745	3	6mm x 1.0 45° Elbow
904-629	4	1/4 NPT 65° Elbow	904-790	5	6mm x 1.0 90° Elbow
904-641	1	1/4-28 Straight	904-702	1	8mm x 1.0 Straight
904-652	7	1/4-28 Straight Long	904-746	3	8mm x 1.0 45° Elbow
904-636	3	1/4-28 45° Short	904-791	5	8mm x 1.0 90° Elbow
904-637	3	1/4-28 45° Long	904-703	1	10mm x 1.0 Straight

GREASE FITTINGS MASTER ASSORT.

No. 020-685

Contains 160 pieces of 17 popular sizes. Packed in a rigid all-metal lidded box.



GREASE FITTINGS ASSORTMENTS

No. 020-901 - Inch
No. 020-902 - Metric

Each assortment contains 100 Grease Fittings in six popular sizes.



020-901 Inch				020-902 Metric			
Part No.	Pcs.	Part No.	Pcs.	Part No.	Pcs.	Part No.	Pcs.
904-641	60	904-691	6	904-701	40	904-745	10
904-610	20	904-688	4	904-702	20	904-746	10
904-637	6	904-613	4	904-703	10	904-790	10

papco® COPPER TUBING TUYAU CUIVRE

Construction: Cold drawn to size, seamless and fully annealed alloy.

Advantages: Soft temper permits single and double flares as well as easy hand shaping.

Applications: Suitable for refrigeration, gasoline and oil lines on automobiles, trucks, marine and diesel engines, oil burners, water lines, industrial and general purpose use.

Available in 25*, 50 and 100 foot coils.

Order by Part Number

Part Number			Outside Diam.	Wall Thick.	Weight per 100 ft.	W/P psi @100°F
25 ft.	50 ft.	100 ft.				
901-221	901-222	901-223	1/8"	.030"	3.5 lbs.	3130
901-231	901-232	901-233	3/16"	.030"	5.8 lbs.	1990
901-241	901-242	901-243	1/4"	.030"	8.0 lbs.	1450
901-251	901-252	901-253	5/16"	.032"	11.0 lbs.	1230
901-261	901-262	901-263	3/8"	.032"	13.4 lbs.	900
901-271	901-272	901-273	1/2"	.032"	18.2 lbs.	740
901-281	901-282	901-283	5/8"	.035"	23.2 lbs.	640
901-291	901-292	901-293	3/4"	.035"	28.0 lbs.	640

* Individually Packaged up to 3/8" O.D.

W/P - Working Pressure

papco® STEEL TUBING TUYAU ACIER

TIN COATED and ANNEALED
.028 Wall Thickness

"Papco" Steel Tubing is ideal for special automotive line replacements that require unusually short or long lengths of tubing. Provides a more economical means of installing hydraulic systems in automotive and truck applications. Standard coil length - 25 ft.

Part No.	Tube Size O.D.
901-131	3/16
901-141	1/4
901-151	5/16
901-161	3/8





The Fastener System for the 'Walk-In' Trade

Turn everyday bolt-nut-screw sales into real profit makers.

- Rigid, reusable packages.
- Compact, space saver displays.
- Saves counterman's time.
- Display popular fasteners for self-serve customers.
- Novel package design - four vibrant colours.
- Label shows size, type, quantity and price code.

Pic-a-Pac dispensing racks can be used on gondolas, pylons or existing display space.

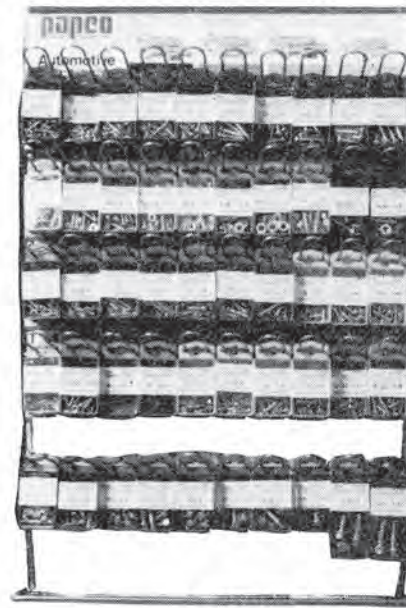

GRADE 5 FASTENERS MERCHANDISER No. 022-205

Includes Rack, Header Sign, Inventory Control Strips, Planogram and a 100 pac stock of the items listed below.

Pac No.	Size	Pcs/Pac	Pac No.	Size	Pcs/Pac	Pac No.	Size	Pcs/Pac	Pac No.	Size	Pcs/Pac
UNC Grade 5 Cap Screws			UNC Grade 5 Cap Screws			UNC Grade 5 Cap Screws			Flat Washers		
008-018	1/4 x 1/2	10	008-056	7/16 x 1	3	008-160	7/16 x 2	3	005-451	1/4	25
008-019	1/4 x 3/4	10	008-058	7/16 x 1-1/2	3	008-165	1/2 x 1-1/2	2	005-452	5/16	20
008-020	1/4 x 1	9	008-060	7/16 x 2	3	008-167	1/2 x 2	2	005-453	3/8	18
008-022	1/4 x 1-1/2	6	008-065	1/2 x 1-1/2	2	UNC Hex Nuts			005-454	7/16	10
008-024	1/4 x 2	4	008-067	1/2 x 2	2	005-651	1/4-20	15	005-455	1/2	8
008-031	5/16 x 3/4	7	UNF Grade 5 Cap Screws			005-652	5/16-18	12	Lock Washers		
008-032	5/16 x 1	6	008-120	1/4 x 1	9	005-653	3/8-16	9	005-551	1/4	25
008-033	5/16 x 1-1/4	5	008-122	1/4 x 1-1/2	6	005-654	7/16-14	5	005-552	5/16	20
008-034	5/16 x 1-1/2	4	008-132	5/16 x 1	6	05-655	1/2-13	3	005-553	3/8	18
008-036	5/16 x 2	3	008-134	5/16 x 1-1/2	4	UNF Hex Nuts			005-554	7/16	10
008-044	3/8 x 1	6	008-146	3/8 x 1-1/2	4	005-671	1/4-28	15	005-555	1/2	8
008-046	3/8 x 1-1/2	4	008-148	3/8 x 2	4	005-672	5/16-24	12			
008-048	3/8 x 2	3	008-158	7/16 x 1-1/2	4	005-673	3/8-24	9			
008-049	3/8 x 2-1/2	3				005-674	7/16-20	5			
008-050	3/8 x 3	2				005-675	1/2-20	3			

AUTOMOTIVE TAPPING and MACHINE SCREWS MERCHANDISER No. 022-206

Includes Rack, Header Sign, Inventory Control Strips, Planogram and a 100 pac stock of the items listed below.

Pac No.	Size	Pcs/Pac	Pac No.	Size	Pcs/Pac	Pac No.	Size	Pcs/Pac	Pac No.	Size	Pcs/Pac
Pan Slot Head Tapping Screws			Hex Washer Head Tapping Screws			Pan Phillips Head Tapping Screws			Round Slot Machine Screws with Nuts		
004-034	6 x 3/4	18	004-504	14 x 3/4	8	004-812	8 x 1/2	12	005-036	6-32 x 3/4	18
004-052	8 x 1/2	18	004-506	14 x 1	7	004-814	8 x 3/4	14	005-051	8-32 x 3/4	14
004-054	8 x 3/4	14	004-508	14 x 1-1/4	5	004-824	10 x 3/4	12	005-052	8-32 x 1	12
004-056	8 x 1/2	12	004-606	5/16 x 1	4	6-Lobe Drive Trim Screws			005-054	8-32 x 1-1/2	10
004-080	10 x 3/4	12	004-608	5/16 x 1-1/4	3	004-835	4.2x20mm Chrome	4	005-108	10-24 x 1	10
004-082	10 x 1	10	004-626	3/8 x 1	3	004-836	4.2x20mm Black	4	005-110	10-24 x 1-1/2	10
004-092	12 x 3/4	14	004-630	3/8 x 1-1/2	2	004-839	4.2x30mm Chrome	4	005-112	10-24 x 2	8
004-094	12 x 1	10	Oval Phillips Small Head			004-840	4.2x20mm Black	4	005-128	1/4-20 x 1	8
004-106	14 x 1	9	004-734	6 x 3/4	16	'Drill-X' Self-Drilling/Tapping Screws			005-130	1/4-20 x 1-1/2	7
004-108	14 x 1-1/2	7	004-754	8 x 3/4	12	004-882	8 x 1/2 Hex	9	005-132	1/4-20 x 2	5
Hex Washer Head Tapping Screws			004-756	8 x 1	10	004-884	8 x 3/4 Hex	7	Flat Slot Machine Screws with Nuts		
004-478	10 x 1/2	14	004-757	8 x 1-1/4	8	004-892	10 x 1/2 Hex	6	005-308	10-24 x 1	10
004-480	10 x 3/4	12	004-780	10 x 3/4	10	004-894	10 x 3/4 Hex	5	005-328	1/4-20 x 1	8
004-502	14 x 1/2	10	004-782	10 x 1	9						
			004-784	10 x 1-1/2	8						

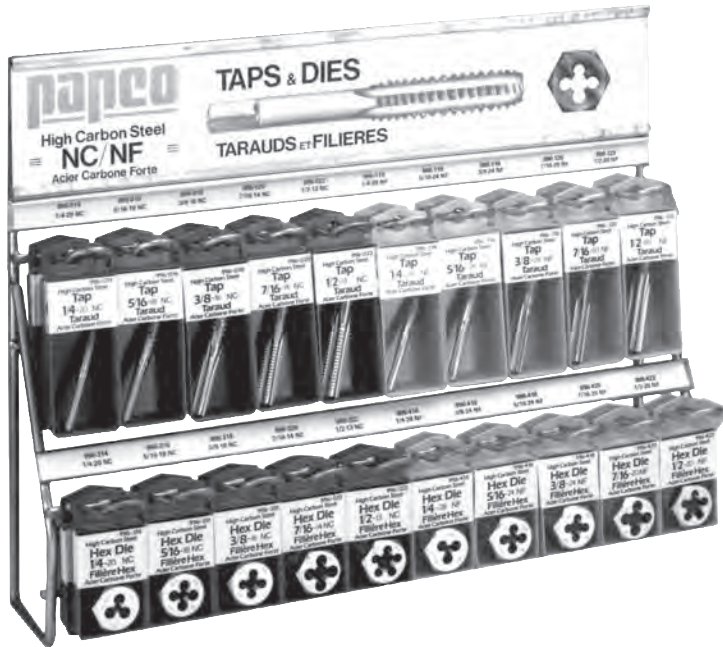

**Merchandisers No. 022-108, 109 and 110
(see next page)**

**Plug
Tap**



**Hex
Die**

'PAPCO' TAPS and DIES

'Papco' Taps and Dies are made of high carbon tool steel, heat treated to industrial specifications and packed in colour-coded, protective packs. Long-life, plug type taps are chamfered for easy starting and cut clean accurate threads. Hexagon dies in sizes to 1/2" and M12 are 1" across flats - larger sizes are 1-7/16" across flats. Use Die Stock No. 996-563 or wrench for driving dies. 'Papco' Taps and Dies are available in NC (National Coarse), NF (National Fine); Metric Standard, Fine and Extra Fine thread pitch - plus N.P.T. (National Pipe Thread) and B.S.P. (British Standard Pipe) for fittings on Import vehicles. Tap and drill sizes are engraved on each tap - starting side and size engraved on dies.

'Papco' HIGH CARBON STEEL, PLUG TYPE TAPS - Individually Packaged											
NC National Coarse			NF National Fine			Metric			Pipe		
Part No.	Size	Drill	Part No.	Size	Drill	Part No.	Size	Drill	Part No.	Size	Drill
996-006	6-32	7/64				996-204	M4x.7	1/8	996-250	1/8-27NPT	11/32
996-008	8-32	9/64				996-205	M5x.8	11/64	996-252	1/4-18NPT	7/16
996-010	10-24	5/32	996-110	10-32	5/32	996-206	M6x.1.0	13/64	996-254	3/8-18NPT	37/64
996-014	1/4-20	13/64	996-114	1/4-28	7/32	996-208	M8x1.25	17/64	996-256	1/2-14NPT	23/32
996-016	5/16-18	17/64	996-116	5/16-24	17/64	996-210	M10x1.5	11/32	996-257	1/8-28BS	5/16
996-018	3/8-16	5/16	996-118	3/8-24	21/64	996-212	M12x1.75	27/64			
996-020	7/16-14	3/8	996-120	7/16-20	25/64	996-230	M8x1.0F	9/32			
996-022	1/2-13	27/64	996-122	1/2-20	29/64	996-231	M10x1.25F	11/32			
996-023	9/16-12	31/64	996-123	9/16-18	33/64	996-232	M12x1.5F	13/32			
996-024	5/8-11	17/32	996-124	5/8-18	37/64	996-240	M10x1.0XF	23/64			
996-026	3/4-10	21/32	996-126	3/4-16	11/16						

F - Fine Thread Pitch
XF - Extra Fine Thread
(Spark Plug)

'Papco' HIGH CARBON STEEL, HEXAGON DIES (1" AF) - Individually Packaged							
NC National Coarse		NF National Fine		Metric		Pipe	
Part No.	Size	Part No.	Size	Part No.	Size	Part No.	Size
996-314	1/4-20	996-414	1/4-28	996-504	M4x.7	996-540	1/8-27 NPT
996-316	5/16-18	996-416	5/16-24	996-505	M5x.8	996-541	1/4-18 NPT
996-318	3/8-16	996-418	3/8-24	996-506	M6x1.0	996-547	1/8-28BS
996-320	7/16-14	996-420	7/16-20	996-508	M8x1.25		
996-322	1/2-13	996-422	1/2-20	996-510	M10x1.5		
996-323*	9/16-12	996-423*	9/16-18	996-512	M12x1.75		
996-324*	5/8-11	996-424*	5/8-18	996-530	M8x1.0 F		
996-326*	3/4-10	996-426*	3/4-16	996-531	M10x1.25 XF		(* 1-7/16" AF)
				996-532	M12x1.5 F		F - Fine Thread Pitch



papeo® THREAD CUTTING TOOLS and MERCHANDISERS PRÉSENTOIRS et OUTILS AUTO-TARAUDEUSES

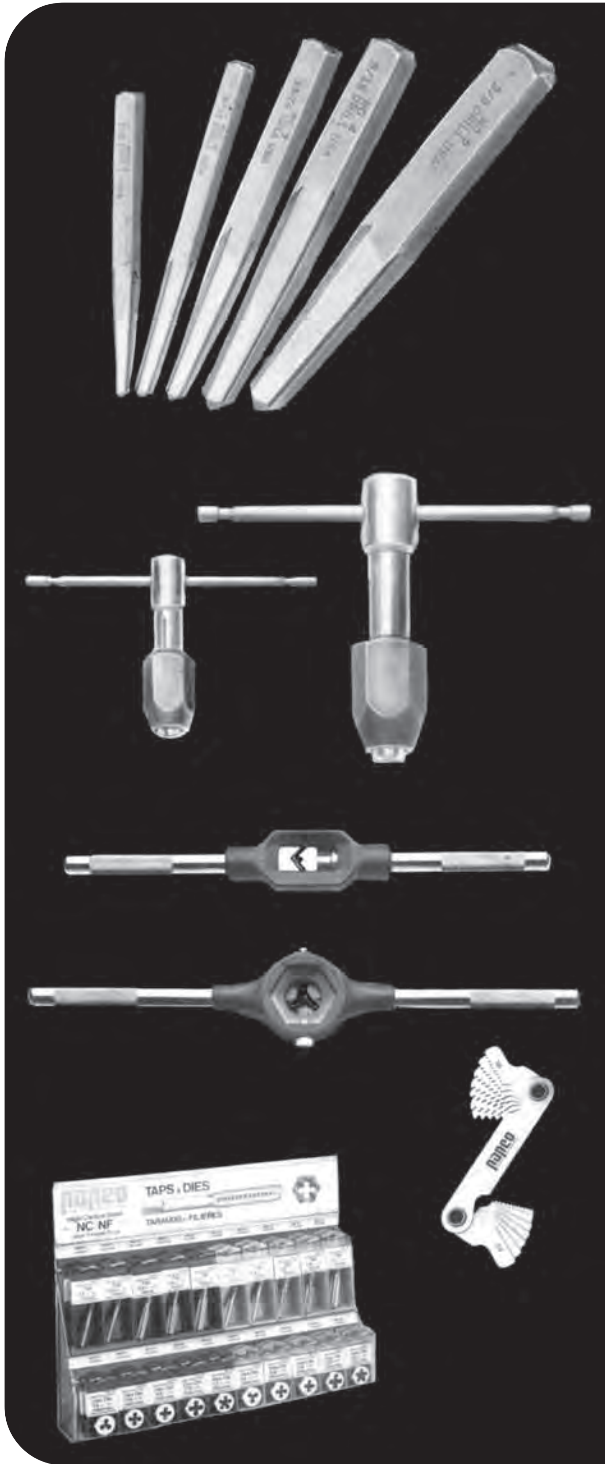

'A' SCREW EXTRACTORS

These chrome-vanadium straight flute extractors are heat treated to give the highest torque specification and may be used with any wrench. Straight tapered flute will not expand the screw or stud being removed. Drill size engraved on each individually packed extractor.

Part No.	Size	Fits Screw Dia.	Use Drill
996-551	No. 1	1/4, 5/16, M6, M8	1/8
996-552	No. 2	3/8, M10, 1/8-27, 1/8-28	3/16
996-553	No. 3*	7/16, M12	15/64
996-554	No. 4	1/2, 9/16, M14, 1/4-18	5/16
996-555	No. 5	5/8, M16, 3/8-18	3/8

*Use for broken Grease Fittings

SCREW EXTRACTOR SET No. 996-550

Consists of five extractors - One each of No. 1 to 5 as listed above.

TOOLS

'B' 'T' - HANDLE TAP WRENCH No. 996-560

Fits taps from No. 0 to 1/4" and features adjustable, self-equalizing wrench jaws. Handle is held in place by spring tension. Individually carded.

'C' 'T' - HANDLE TAP WRENCH No. 996-561

Fits 1/4" to 1/2" taps. Features a removable handle plus a 3/8" female square drive for extensions or ratchet drive. Individually carded.

'D' PROFESSIONAL TAP WRENCH No. 996-562

Fits taps from M4 to 1/2". Industrial quality tool is used for taps, reamers and screw extractors. Adjustable, hardened jaws tighten by turning handles. Individually carded.

'E' DIE STOCK No. 996-563

Professional Die Holder fits 1" hexagon or round dies up to 1/2" or M12. Has three jaw, self-centering, adjustable guides for easy starting and accurate threading. Chrome plated handles. Individually carded.

'F' SCREW PITCH GAUGES

INCH SCREW PITCH GAUGE No. 996-570

For inch threads. 14 blades for threads from 10 to 40 per inch. Individually packaged. (Inch 'pitch' is the number of threads per inch T.P.I.)

METRIC SCREW PITCH GAUGE No. 996-571

For metric threads. 14 blades for pitches from 0.45 to 2.50mm. Individually packaged. (Metric 'pitch' is the distance between threads.)

NC/NF MERCHANDISER No. 022-108 (as illustrated)

Contains one each of 1/4 to 1/2 Coarse and Fine Thread Taps and Dies - 20 sizes. Includes wire rack, header sign and label strips.

METRIC MERCHANDISER No. 022-109

Contains one each of all listed sizes of Metric Standard, Fine and Extra Fine thread pitch Taps and Dies - 19 sizes. Includes wire rack, header sign and label strips.

MERCHANDISER No. 022-110

Contains one each of NPT and BSP Taps and Dies, No. 1 to 5 Screw Extractors, Screw Extractor Set, Inch and Metric Thread Pitch Gauges and a professional Tap and Reamer Wrench. Includes pegboard hooks, header sign and planogram.



These jobber length high speed tool steel drill bits feature a ground body and polished flutes for fast chip removal. Suitable for drilling steel, wood and plastic. Bits are individually (* 2 bits) packaged on bar-coded hang-up cards. Order by Stock No.

Stock No.	Diameter	Length Overall	Stock No.	Diameter	Length Overall	Stock No.	Diameter	Length Overall
HIGH SPEED STEEL DRILLS			HIGH SPEED STEEL DRILLS (cont'd)			HIGH SPEED STEEL DRILLS (cont'd)		
997-104*	1/16"	1-7/8"	997-117	17/64"	4-1/8"	997-130†	15/32"	5-3/4"
997-105*	5/64	2	997-118	9/32	4-1/4	997-131†	31/64	5-7/8
997-106*	3/32	2-1/4	997-119	19/64	4-3/8	997-132†	1/2	6
997-107*	7/64	2-5/8	997-120	5/16	4-1/2	MASONRY DRILLS - Carbide Tip		
997-108*	1/8	2-3/4	997-121	21/64	4-5/8	997-586	3/16"	3-3/8"
997-109	9/64	2-7/8	997-122	11/32	4-3/4	997-587	1/4	4
997-110	5/32	3-1/8	997-123	23/64	4-7/8	997-588	5/16	4-3/4
997-111	11/64	3-1/4	997-124	3/8	5	997-589	3/8	4-3/4
997-112	3/16	3-1/2	997-125†	25/64	5-1/8	997-590†	1/2	5-7/8
997-113	13/64	3-5/8	997-126†	13/32	5-1/4	997-591†	5/8	6
997-114	7/32	3-3/4	997-127†	27/64	5-3/8	997-592†	3/4	6
997-115	15/64	3-7/8	997-128†	7/16	5-1/2			
997-116	1/4	4	997-129†	29/64	5-5/8			

* These sizes 2 bits per card.

† 3/8 Reduced Shank

'Papco' DRILL BIT MERCHANDISER No. 022-115 (As above)

Contains each of the 29 sizes of drill bits from 1/16" to 1/2" by 64ths., including 3/8" reduced shanks, 1/4" to 1/2" Masonry Bits - and 1/8" double-ended panel drills. A total of 82 cards including an attractive header sign and merchandising rack suitable for wall, pegboard, counter, or gondola display.



No. 997-594 1/8" DOUBLE ENDED PANEL DRILL

High speed ground steel with special 135° split point. Made for body panel work. Starts cutting on contact, won't wander, no centre punch required. 1/8" Dia. x 2" long double-ended. Packed 5 bits per pouch.



Papco DRILL SETS

High Speed Steel
Industrial Grade Drill Bits

5 **pic-a-drill** Sets will fill all your drill bit needs!

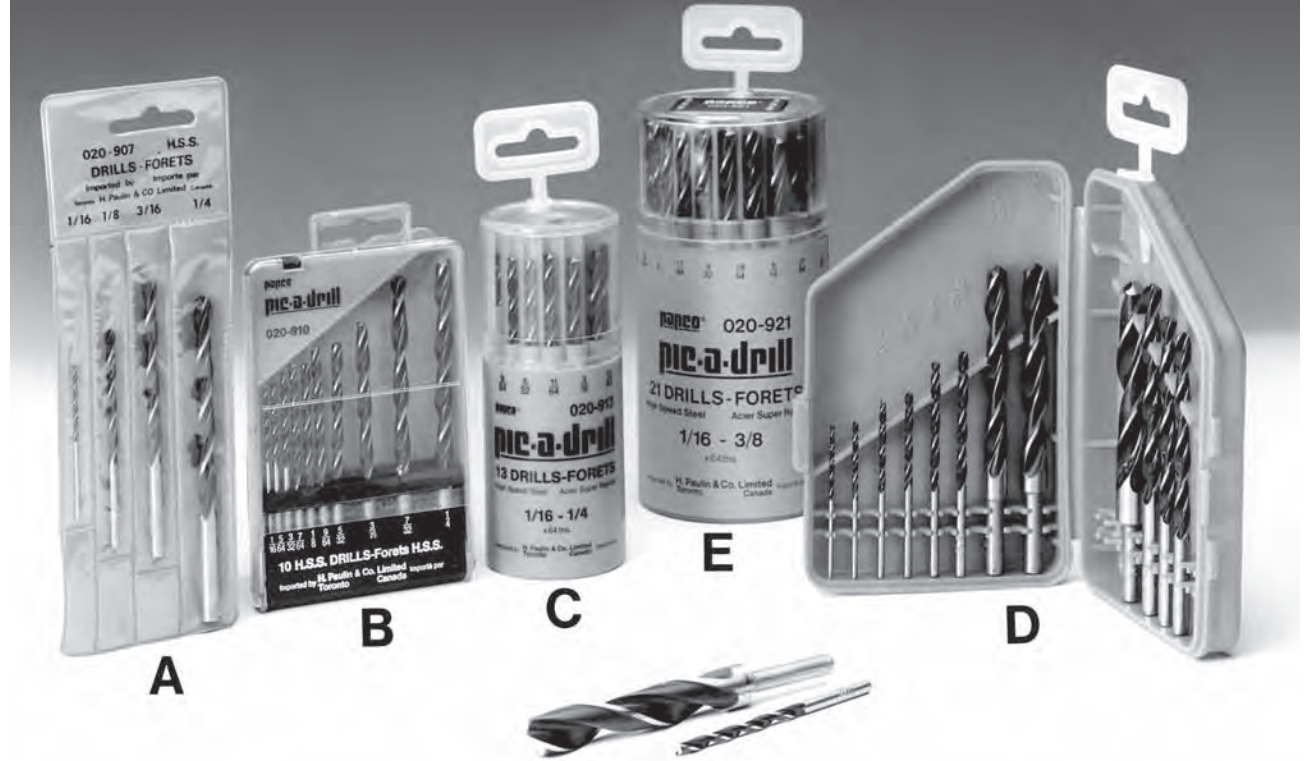

A 'Papco' DRILL BIT ASSORTMENT No. 020-907
4 Pieces – 1/16, 1/8, 3/16, 1/4 H.S.S. 'Pic-a-drill' clear vinyl pouch. The 4 most popular drill sizes. Ideal as a basic kit or to replace worn drills in larger sets.

B 'Papco' DRILL BIT ASSORTMENT No. 020-910
10 Pieces – 1/16 to 1/4 H.S.S.
'Pic-a-drill' rigid styrene case hangs or stands on workbench. Each drill in a separate compartment. Good size coverage in a handy box. 1/16, 5/64, 3/32, 7/64, 1/8, 9/64, 5/32, 3/16, 7/32, 1/4.

C 'Papco' DRILL BIT ASSORTMENT No. 020-913
13 Pieces – 1/16 to 1/4 H.S.S.
'Pic-a-drill' revolving case. 13 popular sizes in a new design rotating case. Dial each size as needed. 1/16, 5/64, 3/32, 7/64, 1/8, 9/64, 5/32, 11/64, 3/16, 13/64, 7/32, 15/64, 1/4.

D 'Papco' DRILL BIT ASSORTMENT No. 020-914
14 Pieces – 1/16 to 1/2 with shanks reduced to 3/8.
'Pic-a-drill' strong folding polypropylene case holds and protects this fine set. 1/16, 5/64, 3/32, 7/64, 1/8, 9/64, 5/32, 3/16, 7/32, 1/4, 5/16, 3/8, and 7/16, 1/2, with 3/8 reduced shanks.

E 'Papco' DRILL BIT ASSORTMENT No. 020-921
21 pieces – 1/16 to 3/8 by 64ths H.S.S.
A complete range of sizes for all requirements. 'Pic-a-drill' revolving case has clear rotating top for fast selection. Drill sizes clearly indexed.

F 'Papco' DRILL BIT MERCHANDISER No. 022-114
A balanced stock of 14 'Pic-a-drill' sets. 6 No. 020-907, 3 No. 020-910, 2 No. 020-913, 2 No. 020-914 and 1 No. 020-921. Includes header sign and merchandising rack. Suitable for wall, pegboard, counter or gondola display.
Size: 16" w. x 14" h. (Illustrated below.)





WOOD SCREWS
VIS A BOIS

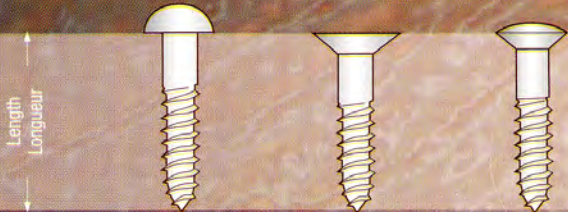

ROUND RONDE
FLAT FRAISEE
OVAL OVALE

TAPPING SCREWS
VIS TARAUDEUSES

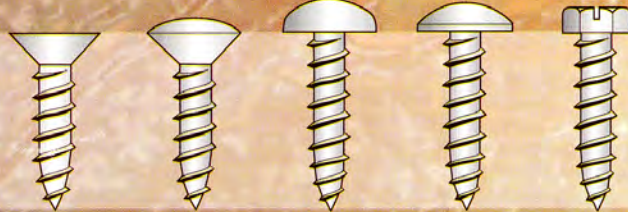

FLAT FRAISEE
OVAL OVALE
PAN DEPOUILLE
TRUSS BOMBEE
HEX HEX

MACHINE SCREWS
VIS DE MECANIQUE

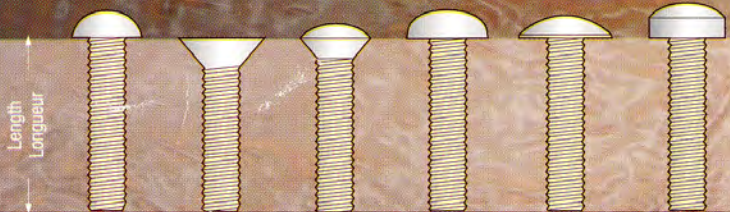

ROUND RONDE
FLAT FRAISEE
OVAL OVALE
PAN PAN
TRUSS BOMBEE
FILLISTER CYLINDRIQUE

CAP SCREWS and BOLTS
BOULONS ET BOULONS DE PRECISION

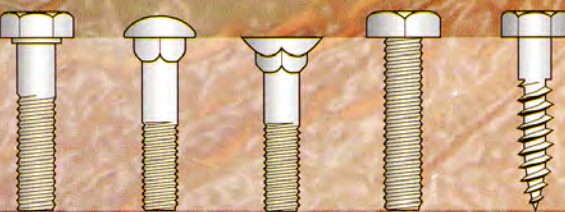

HEX HEX
CARRIAGE CARROSSE
PLOW CHARRUE
SQUARE CARREE
LAG TIRE-FOND

SET SCREWS and STUDS
VIS DE PRESSION et GOUJONS

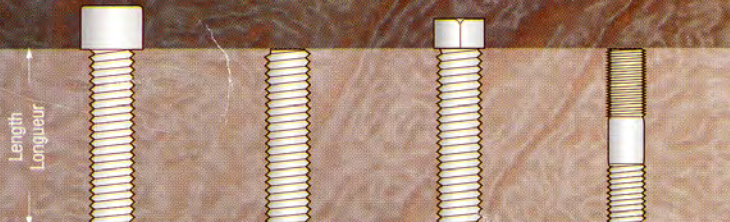

SOCKET CAP BOULONS DE PRESSION
SOCKET SET VIS DE PRESSION
SQUARE SET PRESSION CARREE
STUDS GOUJONS

STANDARD PINS
GOUPILLES REGULIERE



COTTER GOUPILLE
CLEVIS JOUG
TAPER CONIQUE
SPRING RESSORT

HEXAGON NUTS
ECROUS HEXAGON



WIDTH Largeur



Thick Epais

WASHERS
RONDELLES

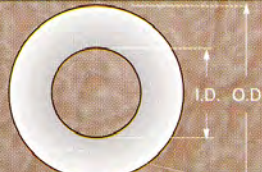

PLAIN STEEL WASHERS
RONDELLES ORDINAIRE



T

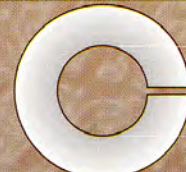

LOCK WASHERS
RONDELLES RESSORT



T