



2018

Residential Condensed Catalog



Table of Contents

- Industry Certifications 4
- Residential Model Nomenclatures 5
- Residential Air Conditioners..... 25
- Residential Heat Pumps 47
- 90% Condensing Gas Furnaces 63
- 80% Gas Furnaces 71
- Oil Furnaces..... 81
- Fan Coils, Evaporator Coils and Blower Coils 93
- Ductless Systems 119
- Small Packaged Products 125
- Controls and IAQ 145
- Geothermal 151

Certifications

ICP Products meet or exceed industry standards.



As an ENERGY STAR® partner, ICP has determined that qualifying models meet ENERGY STAR guidelines for energy efficiency. Visit www.energystar.gov.



Use of the AHRI Certified TM Mark indicates a manufacturer's participation in the program. For verification of certification for individual products, go to www.ahrirectory.org.



Wi-Fi® is a trademark of Wi-Fi Alliance Corporation.

Apple and iOS are trademarks of Apple Inc., registered in the U.S. and other countries.

Android is a trademark of Google Inc.



Residential Model Nomenclatures

90% Gas Furnace

GAS FURNACE MODEL NUMBER IDENTIFICATION GUIDE										
DIGIT POSITION	1	2	3	4	5	6, 7, 8	9, 10	11, 12	13	14
	*	9	M	A	E	060	17	14	A	1
F, G = Mainline N = Entry	BRANDING									
9 = 90% - 100%	EFFICIENCY									
M = Multiposition	FEATURE									
A = ECM Variable Speed V = ECM Variable Speed X = ECM (Speed Select) S = Single-stage T = Two-stage	FEATURE									
B = Base AFUE Efficiency E = Extra AFUE Efficiency C = Communicating D = Dual Certified 2-pipe or 1-pipe R = 2-pipe only S = Single-stage T = Two-stage N = Standard L = Low NOx	FEATURE									
040 = 40,000 BTU/hr 060 = 60,000 BTU/hr 080 = 80,000 BTU/hr 100 = 100,000 BTU/hr 120 = 120,000 BTU/hr 140 = 140,000 BTU/hr	INPUT HEAT									
14 = 14-3/16" 17 = 17-1/2" 21 = 21" 24 = 24-1/2"	CABINET WIDTH									
08 = 800 CFM (max) 10 = 1000 CFM (max) 12 = 1200 CFM (max) 14 = 1400 CFM (max) 16 = 1600 CFM (max) 20 = 2000 CFM (max) 22 = 2200 CFM (max)	NOMINAL MAX. COOLING AIRFLOW @ .5 IN.W.C									
SALES (MAJOR) REVISION DIGIT										
ENGINEERING (MINOR) REVISION DIGIT										

80% Gas Furnace

GAS FURNACE MODEL NUMBER IDENTIFICATION GUIDE										
DIGIT POSITION	1	2	3	4	5	6, 7, 8	9, 10	11, 12	13	14
	*	8	M	X	N	045	14	12	A	1
F, G = Mainline N = Entry		BRANDING								
80 = 80+		EFFICIENCY								
M = Multiposition			FEATURE							
V = ECM Variable Speed										
X = ECM (Speed Select)										
H = Horizontal										
S = Single-stage										
T = Two-stage			FEATURE							
A = Modulating										
D = Dual Certified 2-pipe or 1-pipe										
R = 2-pipe only										
N = Standard										
L = Low NOx			FEATURE							
045 = 44,000 BTU/hr										
070 = 66,000 BTU/hr										
090 = 88,000 BTU/hr										
110 = 110,000 BTU/hr										
135 = 132,000 BTU/hr										
155 = 154,000 BTU/hr			INPUT HEAT							
14 = 14-3/16"										
17 = 17-1/2"										
21 = 21"										
24 = 24-1/2"			CABINET WIDTH							
08 = 800 CFM (max)										
12 = 1200 CFM (max)										
14 = 1400 CFM (max)										
16 = 1600 CFM (max)										
20 = 2000 CFM (max)										
22 = 2200 CFM (max)			NOMINAL MAXIMUM COOLING AIRFLOW @ .5 IN.W.C.							
SALES (MAJOR) REVISION DIGIT										
ENGINEERING (MINOR) REVISION DIGIT										

Gas Furnace Accessories

ACCESSORIES MODEL NUMBER IDENTIFICATION GUIDE							
DIGIT POSITION	1	2	3	4	5, 6, 7	8, 9	10, 11
	N	A	H	A	001	01	DH
N = Non-Branded	BRANDING						
A = Accessory	PRODUCT GROUP						
H = Heating			KIT USAGE				
A = Original							
B = 2nd Generation				MAJOR SERIES			
Product Identifier Number							
Package Quantity							
Type of Kit (Example: DH = Draft Hood - Chimney Adapter)							

ACCESSORIES MODEL NUMBER IDENTIFICATION GUIDE – PRIOR TO 2010							
DIGIT POSITION	1	2	3	4	5, 6, 7	8, 9	
	N	A	H	A	001	DH	
N = Non-Branded	BRANDING						
A = Accessory	PRODUCT GROUP						
H = Heating			KIT USAGE				
A = Original							
B = 2nd Generation				MAJOR SERIES			
Product Identifier Number							
Type of Kit (Example: DH = Draft Hood - Chimney Adapter)							

ACCESSORY PRODUCT IDENTIFIER ASSIGNMENT

AL = ALTERNATE INPUT KIT
 BK = BLOWER KIT
 CV = CONCENTRIC VENT KIT
 DH = DRAFT HOOD
 DK = DRAIN KIT
 FB = WASHABLE FILTER BULK PACK
 FF = FILTER FRAME
 FK = FILTER KIT
 FP = 10 PACK FILTER KIT
 HL = HI ALTITUDE PROPANE KIT
 LP = NATURAL TO PROPANE KIT
 LV = LONG VENT KIT
 NG = PROPANE TO NATURAL GAS KIT
 NK = NEUTRALIZER KIT
 VC = VENT GUARD
 WK = TWINNING KIT
 WL = WARNING LABEL REPLACEMENT KIT

REFER TO PRODUCT SPECIFICATIONS FOR COMPLETE ACCESSORY INFORMATION.

Oil Furnace

OIL FURNACE MODEL NUMBER IDENTIFICATION GUIDE								
DIGIT POSITION	1	2	3	4	5, 6, 7	8	9, 10	11
	N	O	M	V	098	J	12	A
N = Burner included Blank = Burners and Accessories ordered separately								
O = Oil Furnace		FUEL						
C = Downflow/Horizontal D = Downflow/Horizontal H = Horizontal L = Lo-Boy M = Multiposition T = Upflow/Horizontal U = Upflow				FEATURE				
F = Front Breech R = Rear Breech V = Variable Motor				FEATURE				
098 = 98,000 BTU/hr 105 = 105,000 BTU/hr 106 = 106,000 BTU/hr 112 = 112,000 BTU/hr 154 = 154,000 BTU/hr 155 = 155,000 BTU/hr 156 = 156,000 BTU/hr 160 = 160,000 BTU/hr 210 = 210,000 BTU/hr 350 = 350,000 BTU/hr						INPUT HEAT		
A = 20 x 20 B = 24 x 24 C = 21-1/8 x 21-1/2 D = 19 x 20 E = 19 x 24 F = 20 x 24 G = 22 x 30 J = 16 x 19 K = 17-1/2 x 19						SUPPLY PLENUM SIZE		
08 = 800 CFM (max) 12 = 1200 CFM (max) 14 = 1400 CFM (max) 16 = 1600 CFM (max) 18 = 1800 CFM (max) 20 = 2000 CFM (max)						COOLING AIRFLOW		
SALES (MAJOR) REVISION DIGIT								

Air Conditioners and Heat Pumps

OUTDOOR UNIT MODEL NUMBER IDENTIFICATION GUIDE (single phase)											
DIGIT POSITION	1	2	3	4	5, 6	7	8	9	10	11	12
	*	4	A	3	18	A	K	A	1	0	0
C, H, or T = Mainline		BRANDING									
N = Entry											
R = Entry											
V = Variable											
4 = R-410A											
C = Communicating											
S = Single Stage Communicating											
X = R-410A		REFRIGERANT									
A = Air Conditioner											
H = Heat Pump		TYPE									
3 = 13 SEER											
4 = 14 SEER											
5 = 15 SEER											
6 = 16 SEER											
7 = 17 SEER											
8 = 18 SEER											
9 = 19 SEER		NOMINAL EFFICIENCY									
18 = 18,000 BTUH = 1½ tons											
19 = 18,000 BTUH = 1½ tons											
24 = 24,000 BTUH = 2 tons											
25 = 24,000 BTUH = 2 tons											
30 = 30,000 BTUH = 2½ tons											
31 = 30,000 BTUH = 2½ tons											
36 = 36,000 BTUH = 3 tons											
37 = 36,000 BTUH = 3 tons											
42 = 42,000 BTUH = 3½ tons											
43 = 42,000 BTUH = 3½ tons											
48 = 48,000 BTUH = 4 tons											
49 = 48,000 BTUH = 4 tons											
60 = 60,000 BTUH = 5 tons											
61 = 60,000 BTUH = 5 tons		NOMINAL CAPACITY									
A = Standard Grille											
G = Coil Guard Grille											
C = Coastal						FEATURES					
K = 208/230-1-60								VOLTAGE			
Sales Code											
Engineering Revision											
Extra Digit											
Extra Digit											

Ducted Horizontal Air Conditioner and Heat Pumps

OUTDOOR UNIT MODEL NUMBER IDENTIFICATION GUIDE											
Digit Position:	1,2	3	4	5	6,7	8	9	10	11	12	13
Example Part Number:	NH	4	A	4	18	A	K	A	1	0	0
Horizontal Condenser	UNIT										
4 = R-410A	REFRIGERANT										
A = Air Conditioner H = Heat Pump			TYPE								
4 = 14 SEER					NOMINAL EFFICIENCY						
18 = 18,000 BTUH = 1-1/2 tons 24 = 24,000 BTUH = 2 tons 30 = 30,000 BTUH = 2-1/2 tons 36 = 36,000 BTUH = 3 tons 42 = 42,000 BTUH = 3-1/2 tons 48 = 48,000 BTUH = 4 tons 60 = 60,000 BTUH = 5 tons											NOMINAL CAPACITY
A = Standard Grille											FEATURES
K = 208/230-1-60 H = 208/230-3-60 L = 460-3-60											VOLTAGE
Sales Code											
Engineering Revision											
Extra Digit											
Extra Digit											

Air Conditioner and Heat Pumps Accessories

ACCESSORIES PART NUMBER IDENTIFICATION GUIDE								
DIGIT POSITION	1	2	3	4	5	6, 7	8, 9	10, 11
	N	A	S	A	0	01	01	CH
N = Non-Branded	BRANDING							
A = Accessory	PRODUCT GROUP							
S = Split System (AC & HP)			KIT USAGE					
A = Original B = 2nd Generation					MAJOR SERIES			
0 = Generic or Not Applicable 2 = R-22 4 = R-410A							REFRIGERANT	
Product Identifier Number								
Package Quantity								
Type of Kit (Example: CH = Crankcase Heater)								

REFER TO PRODUCT SPECIFICATIONS FOR COMPLETE ACCESSORY INFORMATION.

High Wall Mini-Splits, R-410A

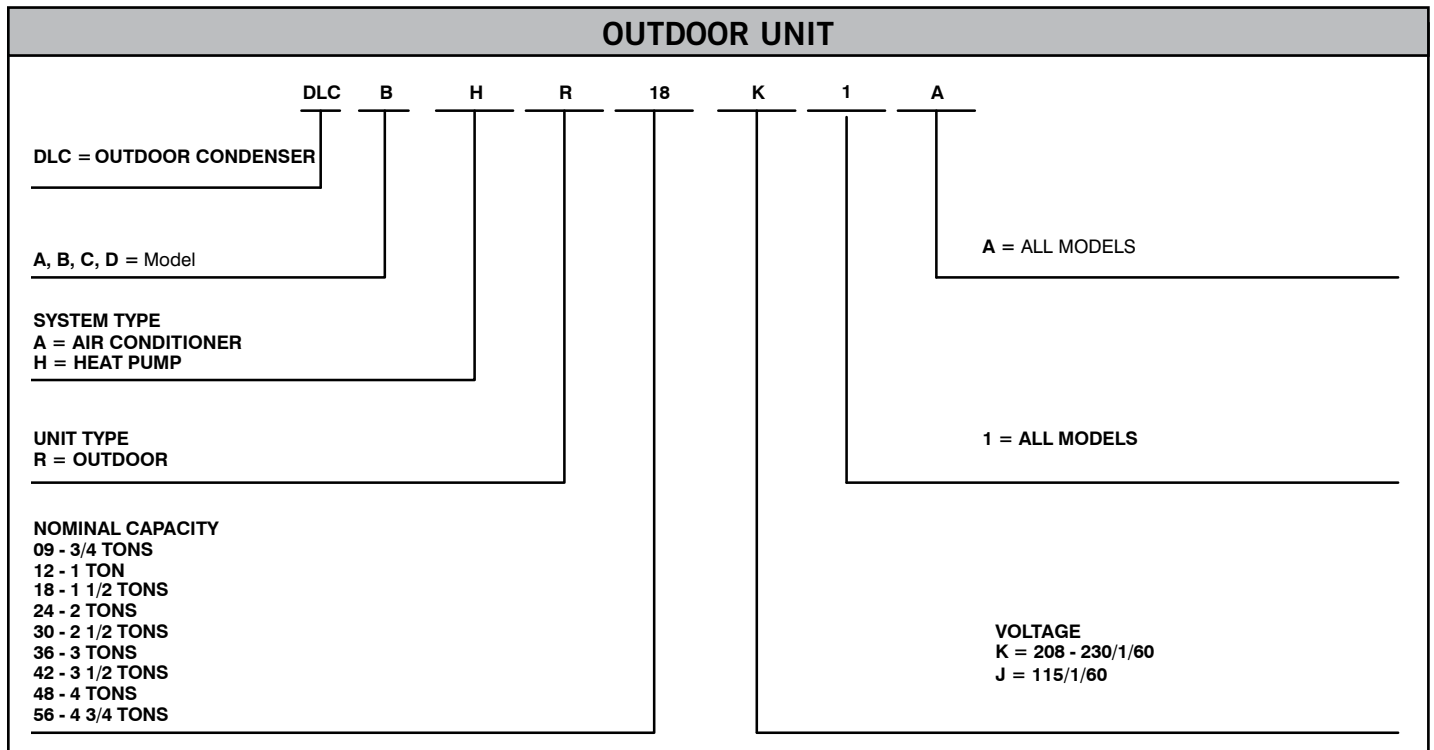
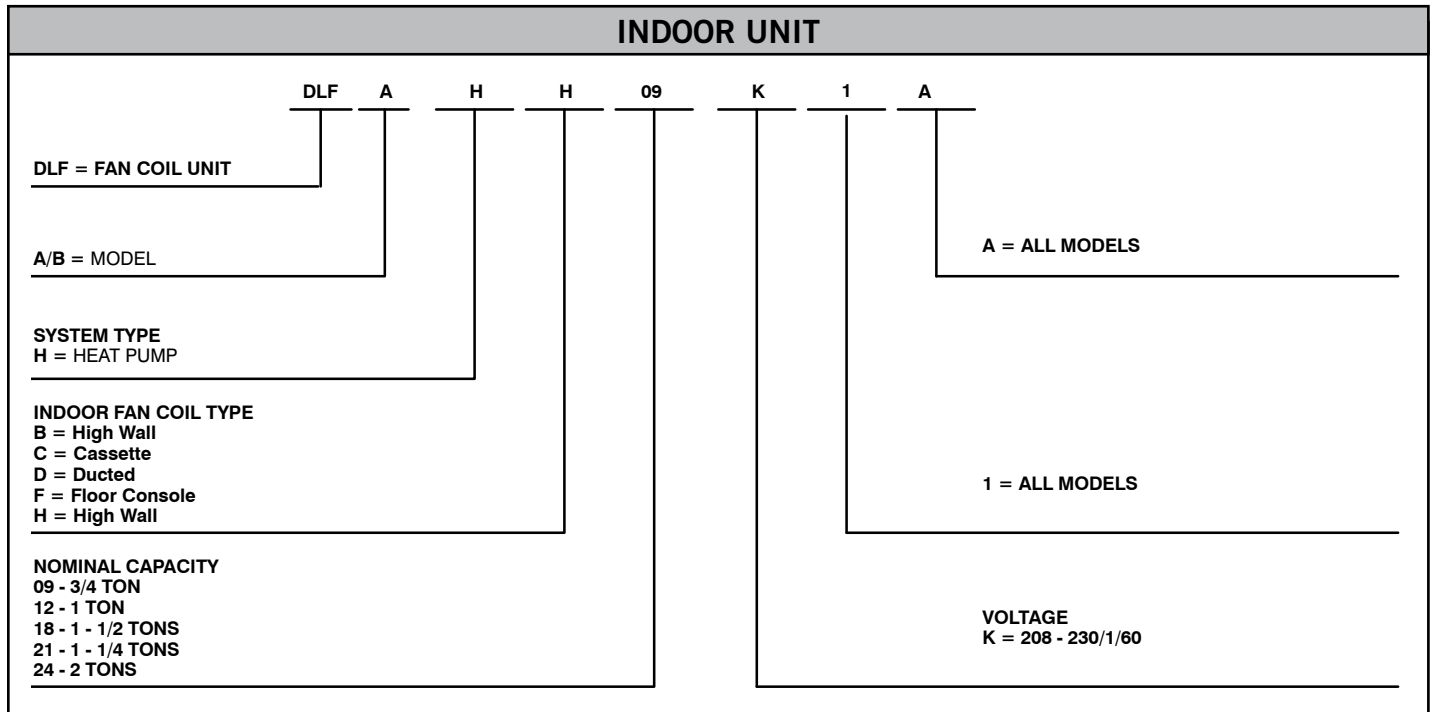

Fan Coils

FVM, FXM, FEM, FSM, FCM series FAN COIL MODEL NUMBER IDENTIFICATION								
DIGIT POSITION	1	2	3	4	5	6,7,8,9	10	11
	F	V	M	4	X	1800	A	T
F = Fan Coil	UNIT							
S = Standard PSC								
E = High efficiency ECM								
C = Communicating								
X = ECM								
V = Variable Speed		MOTOR TYPE						
U = Upflow								
M = Multiposition		INSTALLATION TYPE						
2 = R-22								
4 = Environmentally Sound R-410A				REFRIGERANT				
P = Piston Metering Device								
X = TXV					METERING DEVICE			
1800 = 18,000 BTUH = 1½ tons								
2400 = 24,000 BTUH = 2 tons								
3000 = 30,000 BTUH = 2½ tons								
3500 = 36,000 BTUH = 3 tons								
3600 = 36,000 BTUH = 3 tons								
4200 = 42,000 BTUH = 3½ tons								
4800 = 48,000 BTUH = 4 tons								
6000 = 60,000 BTUH = 5 tons						NOMINAL CAPACITY		
A = Copper Tube, Aluminum Fin Evaporator Coil								
AL = Aluminum Tube, Aluminum Fin Evaporator Coil								
AT = Tin Coated Copper Tubes, Aluminum Fin Evaporator Coil							SALES CODE / FEATURES	

Fan Coils

FMA4P & FMA4X series FAN COIL MODEL NUMBER IDENTIFICATION GUIDE							
FAN COIL MODEL NUMBER IDENTIFICATION GUIDE							
	F	M	A	4	P	2400	A
F = Fan Coil		TYPE		INSTALLATION TYPE		NOMINAL CAPACITY	
M = Multi-Family		TYPE		REFRIGERANT		NOMINAL CAPACITY	
A = Apartment Upflow		INSTALLATION TYPE		REFRIGERANT		NOMINAL CAPACITY	
4 = Environmentally Sound R-410A		INSTALLATION TYPE		REFRIGERANT		NOMINAL CAPACITY	
P = R-410A Piston		INSTALLATION TYPE		REFRIGERANT		NOMINAL CAPACITY	
X = R-410A TXV Standard		INSTALLATION TYPE		REFRIGERANT		NOMINAL CAPACITY	
1800 = 18,000 BTUH = 1-1/2 tons		INSTALLATION TYPE		REFRIGERANT		NOMINAL CAPACITY	
2400 = 24,000 BTUH = 2 tons		INSTALLATION TYPE		REFRIGERANT		NOMINAL CAPACITY	
3000 = 30,000 BTUH = 2-1/2 tons		INSTALLATION TYPE		REFRIGERANT		NOMINAL CAPACITY	
3600 = 36,000 BTUH = 3 tons		INSTALLATION TYPE		REFRIGERANT		NOMINAL CAPACITY	
A = Standard		INSTALLATION TYPE		REFRIGERANT		NOMINAL CAPACITY	
						SALES CODE / FEATURES	

FMU4P, FMU4X, FMC4P, FMC4X series FAN COIL MODEL NUMBER IDENTIFICATION GUIDE							
	F	M	U	4	P	2400	A
F = Fan Coil		TYPE		INSTALLATION TYPE		NOMINAL CAPACITY	
M = Multi-Family		TYPE		REFRIGERANT		NOMINAL CAPACITY	
U = Uncased		INSTALLATION TYPE		REFRIGERANT		NOMINAL CAPACITY	
C = Cased		INSTALLATION TYPE		REFRIGERANT		NOMINAL CAPACITY	
4 = Environmentally Sound R-410A		INSTALLATION TYPE		REFRIGERANT		NOMINAL CAPACITY	
P = R-410A piston		INSTALLATION TYPE		REFRIGERANT		NOMINAL CAPACITY	
1800 = 18,000 BTUH = 1-1/2 tons		INSTALLATION TYPE		REFRIGERANT		NOMINAL CAPACITY	
2400 = 24,000 BTUH = 2 tons		INSTALLATION TYPE		REFRIGERANT		NOMINAL CAPACITY	
3000 = 30,000 BTUH = 2-1/2 tons		INSTALLATION TYPE		REFRIGERANT		NOMINAL CAPACITY	
3600 = 36,000 BTUH = 3 tons		INSTALLATION TYPE		REFRIGERANT		NOMINAL CAPACITY	
A = Standard		INSTALLATION TYPE		REFRIGERANT		NOMINAL CAPACITY	
						SALES CODE / FEATURES	

Fan Coils – Accessories

FVM, FXM, FEM, FSM, EBV series					
FAN COIL ACCESSORY PART NUMBER IDENTIFICATION GUIDE					
DIGIT POSITION	1,2	3,4	5,6	7,8,9	10
	EB	AC	01	NCB	A
EB = Evaporator Blower		UNIT		ACCESSORY TYPE	
AC = Accessory		UNIT		ACCESSORY TYPE	
Product Identifier Number		UNIT		ACCESSORY TYPE	
NCB = Non-Combustible Base Kit		UNIT		ACCESSORY TYPE	
DFS = Down Flow Kit – Slope Coil		UNIT		ACCESSORY TYPE	
DFA = Down Flow Kit – A Coil		UNIT		ACCESSORY TYPE	
PLG = Power Plug (no heat kit)		UNIT		ACCESSORY TYPE	
SPK = Single Point Wiring Kit		UNIT		ACCESSORY TYPE	
FKS = Filter Kit Small		UNIT		ACCESSORY TYPE	
FKM = Filter Kit Medium		UNIT		ACCESSORY TYPE	
FKL = Filter Kit Large		UNIT		ACCESSORY TYPE	
FKX = Filter Kit Extra Large		UNIT		ACCESSORY TYPE	
CTK = Condensate Trap Kit (PVC pipe)		UNIT		ACCESSORY TYPE	
Sales Code		UNIT		ACCESSORY TYPE	

Fan Coil – Electric Heaters

FVM, FXM, FEM, FSM, EBV series FAN COIL ELECTRIC HEATER PART NUMBER IDENTIFICATION GUIDE						
DIGIT POSITION	1,2,3	4,5	6	7	8	9
EHK = Electric Heater Kit	EHK	05	A	K	N	1
05 = 5 kW 07 = 7 kW 09 = 9 kW 10 = 10 kW 15 = 15 kW 18 = 18 kW 20 = 20 kW 25 = 25 kW 30 = 30 kW						
NOMINAL HEAT VALUE						
Sales Code						
K = 208 / 230 single-phase						
H = 208 / 230, 3-phase						
KC = 208 / 230, supplied as single phase, field convertible to 3-phase						
HC = 208 / 230 supplied as 3-phase, field convertible to single phase						
VOLTAGE (60 Hz)						
Product Identifier						
Engineering Revision						

FMA4P, FMA4X series FAN COIL ELECTRIC HEATER PART NUMBER IDENTIFICATION GUIDE				
DIGIT POSITION	1,2,3	4	5,6	7
EHK = Electric Heat Kit	EHK	2	05	B
Sales Code				
05 = 5 kW				
08 = 7.5 kW				
10 = 11 kW				
NOMINAL HEAT VALUE				
Engineering Code				

FMU4P, FMU4X, FMC4P, FMC4X series FAN COIL ELECTRIC HEATER MODEL NUMBER IDENTIFICATION GUIDE				
DIGIT POSITION	1,2,3	4	5,6	7
EHK = Electric Heater Kit	EHK	3	05	B
Sales Code				
05 = 5 kW				
08 = 7.5 kW				
10 = 10 kW				
NOMINAL HEAT VALUE				
Engineering Code				

REFER TO PRODUCT SPECIFICATIONS FOR COMPLETE ACCESSORY INFORMATION.

Furnace Coils (Numerical Widths)

COIL MODEL NUMBER IDENTIFICATION GUIDE										
DIGIT POSITION	1	2	3	4	5	6,7	8	9,10	11	12
	E	N	D	4	X	18	L	14	A	1
E = Evaporator	UNIT									
A = A Coil N = N Coil	TYPE									
A = Uncased D = Cased Upflow/Downflow M = Cased Multiposition (Upflow/Downflow/Horizontal) W = Cased Upflow/Downflow for narrower furnaces H = Cased Horizontal	INSTALLATION									
4 = Environmentally Sound R-410A	REFRIGERANT									
P = Piston X = TXV	METERING DEVICE									
18 = 18,000 BTUH = 1½ tons 19 = 18,000 BTUH = 1½ tons 24 = 24,000 BTUH = 2 tons 30 = 30,000 BTUH = 2½ tons 31 = 30,000 BTUH = 2½ tons 36 = 36,000 BTUH = 3 tons 37 = 36,000 BTUH = 3 tons 42 = 42,000 BTUH = 3½ tons 43 = 42,000 BTUH = 3½ tons 48 = 48,000 BTUH = 4 tons 60 = 60,000 BTUH = 5 tons 61 = 60,000 BTUH = 5 tons	NOMINAL CAPACITY									
C = Copper Tube, Aluminum Fin Evaporator Coil L = Aluminum Tube, Aluminum Fin Evaporator Coil T = Tin Coated Copper Tubes, Aluminum Fin Evaporator Coil	HAIRPIN MATERIAL									
14 = 14-3/16" 17 = 17-1/2" 21 = 21" 24 = 24-1/2"	WIDTH									
Sales Digit (Major Revision)										
Engineering Digit (Minor Revision)										

Furnace Coils (B, F, J, L Widths)

COIL MODEL NUMBER IDENTIFICATION GUIDE									
DIGIT POSITION	1	2	3	4	5	6,7	8	9	10
	E	D	M	2	X	18	B	A	1
E = Evaporator	UNIT								
D = Deluxe		TYPE							
B = Builder (Value Line)									
M = Cased, Multiposition									
D = Cased Upflow / Downflow									
U = Cased Upflow Only									
A = Uncased			APPLICATION						
2 = R-22									
4 = Environmentally Sound R-410A				REFRIGERANT					
X = TXV					METERING DEVICE				
18 = 18,000 BTUH = 1½ tons									
24 = 24,000 BTUH = 2 tons									
30 = 30,000 BTUH = 2½ tons									
36 = 36,000 BTUH = 3 tons									
42 = 42,000 BTUH = 3½ tons									
48 = 48,000 BTUH = 4 tons									
60 = 60,000 BTUH = 5 tons						NOMINAL CAPACITY			
B = 15.5"									
F = 19.1"									
J = 22.8"									
L = 24.5"							WIDTH		
A = Copper Tube, Aluminum Fin Evaporator Coil									
AL = Aluminum Tube, Aluminum Fin Evaporator Coil									
AT = Tin Coated Copper Tubes, Aluminum Fin Evaporator Coil									
							SALES CODE / FEATURES		
Engineering Revision									

Modular Blowers and Electric Furnace

MODULAR BLOWERS and ELECTRIC FURNACE MODEL NUMBER IDENTIFICATION GUIDE							
DIGIT POSITION	1	2	3,4	5,6	7,8	9	10
M = Cased Modular Blower	M	V	08	00	14	C	1
V = Variable Speed ECM Motor 208/230-1-60 F = Electric Furnace 208/230-1-60 B = Blower Cabinet 115-1-60	UNIT						
08 = 800 (2 ton) 12 = 1200 (3 ton) 16 = 1600 (4 ton) 20 = 2000 (5 ton)			NOMINAL CFM				
00 = No Electric Heat			FACTORY INSTALLED ELECTRIC HEAT				
14 = 14-1/2" 17 = 17-1/2" 21 = 21" 24 = 24-1/2"			COIL WIDTH MATCH				
Sales Code							
Engineering Revision							

MODULAR BLOWERS and ELECTRIC FURNACE ACCESSORY PART NUMBER IDENTIFICATION GUIDE							
DIGIT POSITION	1	2	3	4,5,6	7,8	9	10
A = Accessory	A	M	F	001	DF	A	1
C = Cooling H = Heating M = Multi-use (heating and cooling) X = Special	PRODUCT TYPE						
Series							
Product Identifier Number							
DF = Downflow Kit NH= No Heat Kit OT = 2-stage Outdoor Thermostat SP = Single Point Wiring Kit			ACCESSORY TYPE				
Sales Code							
Engineering Revision							

Small Package Units

MODEL NUMBER IDENTIFICATION GUIDE										
DIGIT POSITION	1	2	3	4	5,6	7,8,9	10	11,12	13	14
	P	G	S	4	36	060	K	GP	0	D
P = Package	UNIT									
A = Air Conditioner										
H = Heat Pump										
D = Dual Fuel										
G = Gas/Electric		TYPE								
D = Standard										
J = Dedicated Horizontal (AC or HP only)										
S = Mainline with SS HX			TIER							
4 = 14										
5 = 15					SEER					
24 = 24,000 BTUH = 2 Tons										
30 = 30,000 BTUH = 2.5 Tons										
36 = 36,000 BTUH = 3 Tons										
42 = 42,000 BTUH = 3.5 Tons										
48 = 48,000 BTUH = 4 Tons										
60 = 60,000 BTUH = 5 Tons					NOMINAL COOLING BTUH					
000 = N/A										
040 = 40,000										
060 = 60,000										
090 = 90,000										
115 = 115,000										
120 = 120,000										
130 = 130,000					NOMINAL HEATING BTUH (input)*					
K = 208/230-1-60							VOLTAGE			
00 = No Options										
TP = Tin Plated Evap Main Tubes										
GP = Tin Plated Evap Main Tubes plus Stainless Steel Heat Exchanger *								FACTORY INSTALLED OPTIONS		
0 = Standard										
1 = Low NOx *										FEATURE CODE
Sales Model Digit										

* Gas/electric or Dual Fuel models only

Small Package Units

MODEL NOMENCLATURE										
	1	2	3,4	5,6	7,8,9	10	11,12	13	14	15
MODEL SERIES	P	G	R5	36	090	K	00	0	C	1
P = Package A = Air Conditioner H = Heat Pump G = Gas/Electric D = Dual Fuel TYPE										
R5 = Mainline TIER										
24 = 24,000 BTUH = 2 Tons 36 = 36,000 BTUH = 3 Tons 48 = 48,000 BTUH = 4 Tons 60 = 60,000 BTUH = 5 Tons NOMINAL CLG CAPACITY										
000 = no factory heat 040 = 40,000 BTU/hr 060 = 60,000 BTU/hr 090 = 90,000 BTU/hr 115 = 115,000 BTU/hr 130 = 130,000 BTU/hr NOMINAL HTG BTUH (input)										
K = 208/230-1-60 H = 208/230-3-60 VOLTAGE										
GP = Tin Coated Copper Evap Main Tubes plus Stainless Steel Heat Exchanger GS = Stainless Steel Heat Exchanger FACTORY INSTALLED OPTIONS										
0 = Standard 1 = Low NOx FEATURE CODE										
Sales Model Digit										
Engineering Digit										

MODEL NOMENCLATURE										
	1	2	3,4	5,6	7,8,9	10	11,12	13	14	15
MODEL SERIES	P	A	R5	36	000	K	00	0	C	1
P = Package A = Air Conditioner H = Heat Pump R5 = Mainline TIER										
24 = 24,000 BTUH = 2 Tons 36 = 36,000 BTUH = 3 Tons 42 = 42,000 BTUH = 3 1/2 Tons 48 = 48,000 BTUH = 4 Tons 60 = 60,000 BTUH = 5 Tons NOMINAL CLG CAPACITY										
000 = no factory heat NOMINAL HTG BTUH (input)										
K = 208/230-1-60 H = 208/230-3-60 VOLTAGE										
00 = No options TP – Tin Plated Evaporator Main Tubes FACTORY INSTALLED OPTIONS										
0 = Standard FEATURE CODE										
Sales Model Digit										
Engineering Digit										

Geothermal Heat Pump

UNIT MODEL NUMBER IDENTIFICATION GUIDE												
Digit Position:	1,2	3,4,5	6	7	8	9	10	11	12	13	14,15	16
Example Part Number:	HB	024	V	T	L	C	D	C	C	1	XX	1
HB = Geothermal Package MODEL												
018 = 18,000 BTUH = 1.5 tons 024 = 24,000 BTUH = 2 tons 030 = 30,000 BTUH = 2.5 tons 036 = 36,000 BTUH = 3 tons 042 = 42,000 BTUH = 3.5 tons 048 = 48,000 BTUH = 4 tons 060 = 60,000 BTUH = 5 tons NOMINAL CAPACITY												
V = Vertical H = Horizontal CABINET CONFIGURATION												
T = Top (vertical) E = End (Horizontal) S = Side (horizontal) DISCHARGE AIR CONFIGURATION												
L = Left R = Right RETURN AIR CONFIGURATION												
C = Copper (source) N = Cupronickel (source) COAX OPTIONS												
D = with Desuperheater X = without Desuperheater HOT WATER OPTION												
C = Constant Torque X-13 FAN/MOTOR OPTIONS												
C = Coated fins, Tin Plated Hair Pins AIR COIL COATING												
1 = 208-230/60/1 VOLTAGE												
XX FUTURE USE												
1 ENGINEERING DIGIT												

Geothermal Heat Pump

OUTDOOR UNIT MODEL NUMBER IDENTIFICATION GUIDE (single phase)												
Digit Position:	1,2	3,4,5	6	7	8	9	10	11	12	13	14,15	16
Example Part Number:	HP	024	V	T	L	C	D	E	T	1	XX	1
HP = Geothermal Package MODEL 024 = 24,000 BTUH = 2 tons 036 = 36,000 BTUH = 3 tons 048 = 48,000 BTUH = 4 tons 060 = 60,000 BTUH = 5 tons 072 = 72,000 BTUH = 6.5 tons <p style="text-align: right;">NOMINAL CAPACITY</p>												
V = Vertical H = Horizontal C = Counterflow <p style="text-align: right;">CABINET CONFIGURATION</p>												
T = Top (vertical) B = Bottom (vertical) E = End (Horizontal) S = Side (horizontal) <p style="text-align: right;">DISCHARGE AIR CONFIGURATION</p>												
L = Left R = Right <p style="text-align: right;">RETURN AIR CONFIGURATION</p>												
C = Copper (source) N = Cupronickel (source) <p style="text-align: right;">COAX OPTIONS</p>												
D = with Desuperheater X = without Desuperheater <p style="text-align: right;">HOT WATER OPTION</p>												
E = ECM <p style="text-align: right;">FAN/MOTOR OPTIONS</p>												
T = Tin Plated Hair Pins <p style="text-align: right;">AIR COIL COATING</p>												
1 = 208-230/60/1 <p style="text-align: right;">VOLTAGE</p>												
XX <p style="text-align: right;">FUTURE USE</p>												
1 <p style="text-align: right;">ENGINEERING DIGIT</p>												

Geothermal Split Heat Pump

UNIT MODEL NUMBER IDENTIFICATION GUIDE												
Digit Position:	1,2	3,4,5	6	7	8	9	10	11	12	13	14,15	16
Example Part Number:	HS	024	S	X	X	C	D	X	X	1	XX	1
HS = Geothermal Split MODEL												
024 = 24,000 BTUH = 2 tons 036 = 36,000 BTUH = 3 tons 048 = 48,000 BTUH = 4 tons 060 = 60,000 BTUH = 5 tons NOMINAL CAPACITY												
S = Split System CABINET CONFIGURATION												
X = None (split or water-to-water) DISCHARGE AIR CONFIGURATION												
X = None (split or water-to-water) RETURN AIR CONFIGURATION												
C = Copper (source) N = Cupronickel (source) COAX OPTIONS												
D = with Desuperheater X = without Desuperheater HOT WATER OPTION												
X = None FAN/MOTOR OPTIONS												
X = No air coil AIR COIL COATING												
1 = 208-230/60/1 VOLTAGE												
XX FUTURE USE												
1 ENGINEERING DIGIT												

Water-to-Water Geothermal Heat Pump

UNIT MODEL NUMBER IDENTIFICATION GUIDE												
Digit Position:	1,2	3,4,5	6	7	8	9	10	11	12	13	14,15	16
Example Part Number:	HW	024	W	X	X	D	D	X	X	1	XX	1
HW = Geothermal Water to Water MODEL												
024 = 24,000 BTUH = 2 tons 036 = 36,000 BTUH = 3 tons 048 = 48,000 BTUH = 4 tons 060 = 60,000 BTUH = 5 tons 072 = 72,000 BTUH = 6 tons NOMINAL CAPACITY												
W = Water-to-Water CABINET CONFIGURATION												
X = None (split or water-to-water) DISCHARGE AIR CONFIGURATION												
X = None (split or water-to-water) RETURN AIR CONFIGURATION												
D = Copper (source & load) E = Cupronickel (source & load) F = Copper (source), Cupronickel (load) G = Cupronickel (source), Copper (load) COAX OPTIONS												
D = with Desuperheater X = without Desuperheater HOT WATER OPTION												
X = None FAN/MOTOR OPTIONS												
X = No air coil AIR COIL COATING												
1 = 208-230/60/1 VOLTAGE												
XX FUTURE USE												
1 ENGINEERING DIGIT												

Residential Air Conditioners



CVA9

High-Efficiency up to 19.0 SEER Variable-Speed Air Conditioner with Observer® Communicating Control System

2 – 5 Tons Split System
208 / 230 Volt, Single-Phase, 60 Hz



Recommended
(Sold separately)



Refrigeration Circuit

- Variable-speed compressor operates at five stages with capacity range as wide as 25 - 100%
- High-pressure switch
- Suction pressure transducer
- Pressure equalizer valve for easy starting
- Compressor discharge temperature sensor
- Coil temperature sensor
- Copper tube/aluminum fin coil

Performance

- Up to 13.0 EER
- Integrated inverter control enables five-stage operation with complete Observer Communicating System
- Observer Wall Control with version 5.0 or newer software required for five-stage operation
- Also capable of two-stage operation with two-stage thermostat
- Self-configuring installation with Observer Communicating Wall Control
- Compact ECM fan motor driven by integrated inverter control
- Outdoor temperature sensor factory installed
- High performance compressor sound shield standard
- Isolation compressor grommets
- Enhanced dehumidification

Easy-to-Install and Service

- Text based diagnostics with Observer Communicating Wall Control
- Only two control wires required from communicating indoor unit to condenser
- External high- and low-refrigerant service ports
- Factory charged with R-410A refrigerant
- Adjustments for min and max staging with Observer Communicating Wall Control

Built to Last

- High-gloss, baked-on powder coat finish over galvanized steel
- Post-painted (black) coil fins
- Coated inlet grille with 3/8" (10mm) spacing for extra protection (hail guard)
- Corner posts for extra strength and style

Warranty*

- 10-year No Hassle Replacement™ limited warranty
- Five-year parts limited warranty (including compressor and coil)
 - With timely registration, an additional five-year parts limited warranty (including compressor and coil)

* For residential applications only.
See warranty certificate for complete details and restrictions, including warranty coverage for other applications.



Qualifying models only.

Unit Performance Data

Model Number	Size (tons)	Nominal Btu/hr	Min. Circuit Ampacity	Max. Fuse or Breaker	Operating Dimensions H x W x D (sq) in (mm)	Ship/Operating Weight lbs (kg)
CVA924GKA	2	24,000	13.5	20	31-13/16 x 23-1/8 x 23-1/8 (807 x 587 x 587)	150 /128 (68/58)
CVA925GKA†	2	24,000	23.6	40	38-1/2 x 23-1/8 x 23-1/8 (980 x 587 x 587)	177/152 (80/69)
CVA936GKA	3	36,000	24.2	40	38-1/2 x 23-1/8 x 23-1/8 (980 x 587 x 587)	177/152 (80/69)
CVA937GKA†	3	36,000	26.0	40	38-15/16 x 31-3/16 x 31-3/16 (989 x 242 x 242)	242/205 (110/93)
CVA948GKA	4	48,000	27.3	40	38-15/16 x 31-3/16 x 31-3/16 (989 x 242 x 242)	242/205 (110/93)
CVA949GKA†	4	48,000	26.0	40	43-11/16 x 35 x 35 (1111 x 889 x 889)	285/249 (129/113)
CVA960GKA	5	60,000	40.0	60	42-5/16 x 31-3/16 x 31-3/16 (1075 x 792 x 792)	268/229 (121/104)

† Meets ENERGY STAR® criteria when matched with appropriate coil.

CCA7

High-Efficiency up to 17.0 SEER Two-Stage Air Conditioner with Observer® Communicating Control System



Recommended
(Sold separately)

2 – 5 Tons Split System
208 / 230 Volt, Single-Phase, 60 Hz

Refrigeration Circuit

- Copeland Scroll™ UltraTech™ compressors on all models
- Filter drier supplied with every unit for field installation
- External high- and low-refrigerant service ports
- High- and low-pressure switches
- Copper tube/aluminum fin coil

Performance

- Communicating, self-configuring operation when used with Observer Communicating Wall Control
- Outdoor temperature sensor factory installed
- Ball bearing PSC fan motors on all models
- High performance compressor sound shield standard
- Isolation compressor grommets

Easy-to-Install and Service

- Text based diagnostics with Observer Communicating Wall Control
- Only two control wires required from communicating indoor unit to condenser
- Easy access service valves on all models
- Innovative control box design
- Only two screws to access control panel
- Factory charged with R-410A refrigerant

Built to Last

- High-gloss, baked-on powder coat finish over galvanized steel
- Post-painted (black) coil fins
- Coated, weather-resistant cabinet screws
- Coated inlet grille with 3/8" (10mm) spacing for extra protection (hail guard)
- Corner posts for extra strength and style

Warranty*

- 10-year No Hassle Replacement™ limited warranty
- Five-year parts limited warranty (including compressor and coil)
 - With timely registration, an additional five-year parts limited warranty (including compressor and coil)

* For residential applications only. See warranty certificate for complete details and restrictions, including warranty coverage for other applications.



Unit Performance Data

Model Number	Size (tons)	Nominal Btu/hr	Min. Circuit Ampacity	Max. Fuse or Breaker	Operating Dimensions H x W x D (sq) in (mm)	Ship/Operating Weight lbs (kg)
CCA724GKA	2	24,000	14.5	20	35-7/16 x 31-3/16 x 31-3/16 (900 x 792 x 792)	222/183 (101/83)
CCA736GKA	3	36,000	19.8	25	35-7/16 x 31-3/16 x 31-3/16 (900 x 792 x 792)	256/217 (116/98)
CCA748GKA	4	48,000	27.8	40	40-1/8 x 35 x 35 (1019 x 889 x 889)	326/283 (148/128)
CCA760GKB	5	60,000	37.3	60	40-1/8 x 35 x 35 (1019 x 889 x 889)	327/284 (148/129)

CSA6

Up to 16.0 SEER Single-Stage Air Conditioner with Observer® Communicating Control System

1-1/2 – 5 Tons Split System
208 / 230 Volt, Single-Phase, 60 Hz



Recommended
(Sold separately)



Refrigeration Circuit

- Scroll compressors on all models
- Filter drier supplied with every unit for field installation
- External high- and low-refrigerant service ports
- Copper tube/aluminum fin coil

Performance

- Communicating, self-configuring operation when used with Observer Communicating Wall Control
- Outdoor temperature sensor factory installed
- Compressor sound blanket standard
- Isolation compressor grommets

Easy-to-Install and Service

- Text based diagnostics with Observer Communicating Wall Control
- Easy access service valves on all models
- Innovative control box design
- High- and low-pressure switches
- Fan motor in-line disconnect plug
- Only two screws to access control panel
- Factory charged with R-410A refrigerant

Built to Last

- High-gloss, baked-on powder coat finish over galvanized steel
- Post-painted (black) coil fins
- Coated, weather-resistant cabinet screws
- Coated inlet grille with 3/8" (10mm) spacing for extra protection (hail guard)
- Corner posts for extra strength and style

Warranty*

- Five-year No Hassle Replacement™ limited warranty
- Five-year parts limited warranty (including compressor and coil)
 - With timely registration, an additional five-year parts limited warranty (including compressor and coil)

* For residential applications only. See warranty certificate for complete details and restrictions, including warranty coverage for other applications.

Unit Performance Data

Model Number	Size (tons)	Nominal Btu/hr	Min. Circuit Ampacity	Max. Fuse or Breaker	Operating Dimensions H x W x D (sq) in (mm)	Ship/Operating Weight lbs (kg)
CSA618GKA	1-1/2	18,000	11.8	20	28-9/16 x 31-3/16 x 31-3/16 (726 x 792 x 792)	213/176 (96/80)
CSA624GKA	2	24,000	17.6	25	28-9/16 x 31-3/16 x 31-3/16 (726 x 792 x 792)	212/176 (96/80)
CSA630GKA	2-1/2	30,000	16.7	25	32 x 31-3/16 x 31-3/16 (813 x 792 x 792)	223/187 (101/85)
CSA636GKA	3	36,000	18.1	30	29-7/8 x 35 x 35 (760 x 889 x 889)	243/200 (110/91)
CSA642GKA	3-1/2	42,000	23.6	40	40-1/8 x 35 x 35 (1019 x 889 x 889)	297/253 (135/115)
CSA648GKA	4	48,000	26.1	40	40-1/8 x 35 x 35 (1019 x 889 x 889)	340/295 (155/114)
CSA660GKA	5	60,000	28.0	40	46-7/8 x 35 x 35 (1191 x 889 x 889)	374/327 (169/148)

14.0 SEER Single-Stage Air Conditioner with Observer® Communicating Control System

1-1/2 – 5 Tons Split System
208 / 230 Volt, Single-Phase, 60 Hz



Recommended
(Sold separately)

Refrigeration Circuit

- Copeland Scroll™ compressors on all models
- Filter drier supplied with every unit for field installation
- External high- and low-refrigerant service ports
- Copper tube/aluminum fin coil

Performance

- Communicating, self-configuring operation when used with Observer Communicating Wall Control
- Outdoor temperature sensor factory installed
- Compressor sound blanket standard
- Isolation compressor grommets

Easy-to-Install and Service

- Text based diagnostics with Observer Communicating Wall Control
- Easy access service valves on all models
- Innovative control box design
- High- and low-pressure switches
- Fan motor in-line disconnect plug
- Only two screws to access control panel
- Factory charged with R-410A refrigerant

Built to Last

- High-gloss, baked-on powder coat finish over galvanized steel
- Post-painted (black) coil fins
- Coated, weather-resistant cabinet screws
- Coated inlet grille with 3/8" (10mm) spacing for extra protection (hail guard)
- Corner posts for extra strength and style

Warranty*

- Three-year No Hassle Replacement™ limited warranty
- Five-year parts limited warranty (including compressor and coil)
 - With timely registration, an additional five-year parts limited warranty (including compressor and coil)

* For residential applications only. See warranty certificate for complete details and restrictions, including warranty coverage for other applications.

Unit Performance Data

Model Number	Size (tons)	Nominal Btu/hr	Min. Circuit Ampacity	Max. Fuse or Breaker	Operating Dimensions H x W x D (sq) in (mm)	Ship/Operating Weight lbs (kg)
CSA518GKA	1-1/2	18,000	11.8	20	28-11/16 x 31-3/16 x 31-3/16 (729 x 793 x 793)	213/176 (97/80)
CSA524GKA	2	24,000	17.6	25	28-11/16 x 31-3/16 x 31-3/16 (729 x 793 x 793)	213/176 (97/80)
CSA530GKA	2-1/2	30,000	16.8	25	32-1/8 x 31-3/16 x 31-3/16 (816 x 793 x 793)	199/135 (90/75)
CSA536GKA	3	36,000	18.1	30	35-1/2 x 31-3/16 x 31-3/16 (902 x 793 x 793)	211/177 (96/80)
CSA542GKA	3-1/2	42,000	22.3	35	28-11/16 x 31-3/16 x 31-3/16 (729 x 793 x 793)	237/203 (108/92)
CSA548GKA	4	48,000	20.8	35	28-11/16 x 31-3/16 x 31-3/16 (729 x 793 x 793)	238/204 (108/93)
CSA560GKA	5	60,000	27.5	40	32-1/8 x 31-3/16 x 31-3/16 (816 x 793 x 793)	257/225 (117/102)

C4A3

Efficient 13.0 SEER Air Conditioner Environmentally Balanced R-410A Refrigerant

2 – 5 Tons Split System
208 / 230 Volt, Single-Phase, 60 Hz



Refrigeration Circuit

- Copeland Scroll™ compressors on all models
- Filter drier supplied with every unit for field installation
- External high- and low-refrigerant service ports
- Copper tube/aluminum fin coil

Performance

- Two-speed fan motors factory wired on all models
- Compressor Sound Jacket standard

Easy-to-Install and Service

- Comfort Alert™ diagnostics device on all models
- Easy access service valves on all models
- Innovative control box design
- High- and low-pressure switches
- Fan motor in-line disconnect plug
- Only two screws to access control panel
- Factory charged with R-410A refrigerant

Built to Last

- High-gloss, baked-on powder coat finish over galvanized steel
- Post-painted (black) coil fins
- Coated, weather-resistant cabinet screws
- Coated inlet grille with 3/8" (10mm) spacing for extra protection (hail guard)
- Corner posts for extra strength and style

Warranty*

- One-year No Hassle Replacement™ limited warranty
- Five-year compressor limited warranty
- Five-year parts limited warranty (including compressor and coil)
 - With timely registration, an additional five-year parts limited warranty (including compressor and coil)

* For residential applications only. See warranty certificate for complete details and restrictions, including warranty coverage for other applications.

Unit Performance Data

Model Number	Size (tons)	Nominal Btu/hr	Min. Circuit Ampacity	Max. Fuse or Breaker	Operating Dimensions H x W x D (sq) in (mm)	Ship/Operating Weight lbs (kg)
C4A318GKF	1-1/2	18,000	11.8	20	25-3/16 x 23-1/8 x 23-1/8 (640 x 587 x 587)	143/117 (65/53)
C4A324GKF	2	24,000	17.6	25	28-11/16 x 31-3/16 x 31-3/16 (729 x 793 x 793)	213/176 (97/80)
C4A330GKF	2-1/2	30,000	16.8	25	32-1/8 x 31-3/16 x 31-3/16 (816 x 793 x 793)	199/165 (90/75)
C4A336GKN	3	36,000	21.9	35	25-3/16 x 31-3/16 x 31-3/16 (640 x 793 x 793)	196/160 (89/73)
C4A342GKN	3-1/2	42,000	23.5	40	32-1/8 x 31-3/16 x 31-3/16 (816 x 793 x 793)	230/195 (104/89)
C4A348GKN	4	48,000	26.0	40	35-1/2 x 31-3/16 x 31-3/16 (902 x 793 x 793)	243/203 (110/92)
C4A360GKN	5	60,000	34.2	50	28-11/16 x 31-3/16 x 31-3/16 (729 x 793 x 793)	250/215 (113/98)



N4A7

**Efficient up to 17.0 SEER/12.0-12.5 EER Air Conditioner
Environmentally Balanced R-410A Refrigerant**

**2 – 5 Tons Split System
208 / 230 Volt, Single-Phase, 60 Hz**

Refrigeration Circuit

- Two-stage scroll compressors on all models
- Filter drier supplied with every unit for field installation
- Copper tube/aluminum fin coil

Easy-to-Install and Service

- Easy access service valves on all models
- External high- and low-refrigerant service ports
- Only two screws to access control panel
- Factory charged with R-410A refrigerant

Built to Last

- Baked-on powder coat finish over galvanized steel
- Post-painted (black) coil fins
- Coated, weather-resistant cabinet screws
- Coated inlet grille with 3/8" (10mm) spacing for extra protection (hail guard)

Warranty*

- Five-year parts limited warranty (including compressor and coil)
 - With timely registration, an additional five-year parts limited warranty (including compressor and coil)

* For residential applications only. See warranty certificate for complete details and restrictions, including warranty coverage for other applications.

Unit Performance Data

Model Number	Size (tons)	Nominal Btu/hr	Min. Circuit Ampacity	Max. Fuse or Breaker	Operating Dimensions H x W x D (sq) in (mm)	Ship/Operating Weight lbs (kg)
N4A724GKA	2	24,000	14.5	25	32-1/2 x 31-3/16 x 31-3/16 (901 x 792 x 792)	206/167 (93/76)
N4A736GKA	3	36,000	19.8	30	32-1/2 x 31-3/16 x 31-3/16 (901 x 792 x 792)	230/191 (104/87)
N4A748GKA	4	48,000	27.8	40	38-7/8 x 35 x 35 (988 x 889 x 889)	295/253 (134/115)
N4A760GKA	5	60,000	37.3	60	38-7/8 x 35 x 35 (988 x 889 x 889)	299/258 (136/117)

NXA6

High-Efficiency up to 16.0 SEER Air Conditioner Environmentally Balanced R-410A Refrigerant

1-1/2 – 5 Tons Split System
208 / 230 Volt, Single-Phase, 60 Hz



Refrigeration Circuit

- Scroll compressors on all models
- Filter drier supplied with every unit for field installation
- Copper tube/aluminum fin coil
- 48 and 60 models for higher SEER, lower capacity
- 49 and 61 models for higher capacity, lower SEER

Easy-to-Install and Service

- Easy access service valves on all models
- External high- and low-refrigerant service ports
- Only two screws to access control panel
- Factory charged with R-410A refrigerant

Built to Last

- Baked-on powder coat finish over galvanized steel
- Post-painted (black) coil fins
- Coated, weather-resistant cabinet screws
- Coated inlet grille with 3/8" (10mm) spacing for extra protection (hail guard)

Warranty*

- Five-year parts limited warranty (including compressor and coil)
 - With timely registration, an additional five-year parts limited warranty (including compressor and coil)

* For residential applications only. See warranty certificate for complete details and restrictions, including warranty coverage for other applications.



Unit Performance Data

Model Number	Size (tons)	Nominal Btu/hr	Min. Circuit Ampacity	Max. Fuse or Breaker	Operating Dimensions H x W x D (sq) in (mm)	Ship/Operating Weight lbs (kg)
NXA618GKA	1-1/2	18,000	11.8	20	28-11/16 x 25-3/4 x 25-3/4 (729 x 654 x 654)	154/125 (70/57)
NXA624GKA	2	24,000	17.7	30	28-5/16 x 31-3/16 x 31-3/16 (719 x 792 x 792)	183/147 (85/67)
NXA630GKA	2-1/2	30,000	16.8	25	32-5/16 x 31-3/16 x 31-3/16 (821 x 792 x 792)	188/153 (85/69)
NXA636GKA	3	36,000	18.1	30	28-5/16 x 35 x 35 (719 x 889 x 889)	204/165 (93/75)
NXA642GKA	3-1/2	42,000	23.6	40	39-1/8 x 35 x 35 (994 x 889 x 889)	254/213 (115/96)
NXA648GKA	4	48,000	26.1	40	39-1/8 x 35 x 35 (994 x 889 x 889)	317/264 (144/120)
NXA649GKA	4	48,000	38.4	40	39-1/8 x 35 x 35 (994 x 889 x 889)	269/231 (122/105)
NXA660GKA	5	60,000	28.0	40	45-15/16 x 35 x 35 (1167 x 889 x 889)	310/272 (141/123)



N4A6

**Efficient up to 16.5 SEER/12.2-13.0 EER Air Conditioner
Environmentally Balanced R-410A Refrigerant**

**1-1/2 – 5 Tons Split System
208 / 230 Volt, Single-Phase, 60 Hz**

Refrigeration Circuit

- Scroll compressors on all models
- Filter drier supplied with every unit for field installation
- Copper tube/aluminum fin coil

Easy-to-Install and Service

- Easy access service valves on all models
- External high- and low-refrigerant service ports
- Only two screws to access control panel
- Factory charged with R-410A refrigerant

Built to Last

- Baked-on powder coat finish over galvanized steel
- Post-painted (black) coil fins
- Coated, weather-resistant cabinet screws
- Coated inlet grille with 3/8" (10mm) spacing for extra protection (hail guard)

Warranty*

- Five-year parts limited warranty (including compressor and coil)
 - With timely registration, an additional five-year parts limited warranty (including compressor and coil)

* For residential applications only. See warranty certificate for complete details and restrictions, including warranty coverage for other applications.

Unit Performance Data

Model Number	Size (tons)	Nominal Btu/hr	Min. Circuit Ampacity	Max. Fuse or Breaker	Operating Dimensions H x W x D (sq) in (mm)	Ship/Operating Weight lbs (kg)
N4A618GKA	1-1/2	18,000	11.7	20	25 x 25-3/4 x 25-3/4 (635 x 654 x 654)	145/122 (66/55)
N4A624GKA	2	24,000	14.4	25	32-5/16 x 25-3/4 x 25-3/4 (821 x 654 x 654)	148/123 (67/56)
N4A630GKA	2-1/2	30,000	16.8	25	39-1/8 x 31-3/16 x 31-3/16 (994 x 792 x 792)	201/164 (91/74)
N4A636GKA	3	36,000	18.2	30	28-5/16 x 35 x 35 (719 x 889 x 889)	204/165 (93/75)
N4A642GKA	3-1/2	42,000	21.8	35	28-5/16 x 35 x 35 (719 x 889 x 889)	247/210 (112/95)
N4A648GKA	4	48,000	26.1	40	39-1/8 x 35 x 35 (993 x 889 x 889)	317/264 (144/120)
N4A660GKA	5	60,000	28.0	40	45-15/16 x 35 x 35 (1167 x 889 x 889)	310/272 (141/123)

NXA4

Efficient 14.0 SEER Air Conditioner Environmentally Balanced R-410A Refrigerant

1-1/2 – 5 Tons Split System
208 / 230 Volt, Single-Phase, 60 Hz



Refrigeration Circuit

- Scroll compressors on all models
- Filter drier supplied with every unit for field installation
- Copper tube/aluminum fin coil

Easy-to-Install and Service

- Easy access service valves on all models
- External high- and low-refrigerant service ports
- Only two screws to access control panel
- Factory charged with R-410A refrigerant

Built to Last

- Baked-on powder coat finish over galvanized steel
- Post-painted (black) coil fins
- Coated, weather-resistant cabinet screws
- Coated inlet grille with 2" (51mm) spacing standard, alternate models available with 3/8" (10mm) spacing for extra protection (hail guard)

Warranty*

- Five-year parts limited warranty (including compressor and coil)
 - With timely registration, an additional five-year parts limited warranty (including compressor and coil)

* For residential applications only. See warranty certificate for complete details and restrictions, including warranty coverage for other applications.

Unit Performance Data

Model Number	Size (tons)	Nominal Btu/hr	Min. Circuit Ampacity	Max. Fuse or Breaker	Operating Dimensions H x W x D (sq) in (mm)	Ship/Operating Weight lbs (kg)
NXA418GKC	1-1/2	18,000	11.7	20	24-13/16 x 23-1/8 x 23-1/8 (630 x 587 x 587)	134/123 (61/56)
NXA424GKC	2	24,000	14.1	20	25 x 25-3/4 x 25-3/4 (635 x 654 x 654)	140/119 (84/54)
NXA430GKC	2-1/2	30,000	16.8	25	31-13/16 x 31-3/16 x 31-3/16 (808 x 792 x 792)	186/151 (84/68)
NXA436GKC	3	36,000	18.7	30	24-13/16 x 31-3/16 x 31-3/16 (630 x 792 x 792)	151/134 (87/68)
NXA442GKC	3-1/2	42,000	22.3	35	39-1/8 x 31-3/16 x 31-3/16 (994 x 792 x 792)	232/192 (105/87)
NXA448GKC	4	48,000	20.9	35	28-7/16 x 31-3/16 x 31-3/16 (722 x 792 x 792)	200/182 (91/82)
NXA460GKC	5	60,000	27.5	40	31-13/16 x 31-3/16 x 31-3/16 (808 x 792 x 792)	218/197 (99/89)



N4A5

Efficient 14.0 SEER/11.7-12.2 EER Air Conditioner Environmentally Balanced R-410A Refrigerant

1-1/2 – 5 Tons Split System
208 / 230 Volt, Single-Phase, 60 Hz

Refrigeration Circuit

- Scroll compressors on all models
- Copper tube/aluminum fin coil

Easy-to-Install and Service

- Easy access service valves on all models
- External high- and low-refrigerant service ports
- Only two screws to access control panel
- Factory charged with R-410A refrigerant

Built to Last

- Baked-on powder coat finish over galvanized steel
- Post-painted (black) coil fins
- Coated, weather-resistant cabinet screws
- Coated inlet grille with 3/8" (10mm) spacing for extra protection (hail guard)

Warranty*

- Five-year parts limited warranty (including compressor and coil)
 - With timely registration, an additional five-year parts limited warranty (including compressor and coil)

* For residential applications only. See warranty certificate for complete details and restrictions, including warranty coverage for other applications.

Unit Performance Data

Model Number	Size (tons)	Nominal Btu/hr	Min. Circuit Ampacity	Max. Fuse or Breaker	Operating Dimensions H x W x D (sq) in (mm)	Ship/Operating Weight lbs (kg)
N4A518GKC	1-1/2	18,000	11.7	20	25 x 25-3/4 x 25-3/4 (635 x 654 x 654)	145/122 (66/55)
N4A524GKC	2	24,000	14.1	20	32-5/16 x 25-3/4 x 25-3/4 (821 x 654 x 654)	148/123 (67/56)
N4A530GKC	2-1/2	30,000	16.8	25	31-13/16 x 31-3/16 x 31-3/16 (808 x 792 x 792)	186/151 (84/69)
N4A536GKC	3	36,000	18.1	30	35-3/16 x 31-3/16 x 31-3/16 (894 x 792 x 792)	171/151 (78/69)
N4A542GKC	3-1/2	42,000	22.3	35	31-3/16 x 28-7/16 x 28-7/16 (792 x 722 x 722)	226/191 (103/87)
N4A548GKC	4	48,000	20.9	35	28-7/16 x 31-3/16 x 31-3/16 (722 x 792 x 792)	200/182 (91/83)
N4A560GKC	5	60,000	27.5	40	31-13/16 x 31-3/16 x 31-3/16 (808 x 792 x 792)	218/197 (99/89)

N4A4-C

Coastal 14.0 SEER Air Conditioner R-410A Refrigerant

1-1/2 – 5 Tons Split System
208 / 230 Volt, Single-Phase, 60 Hz



Refrigeration Circuit

- Scroll compressors on all models
- Filter drier supplied with every unit for field installation
- Copper tube/aluminum fin coil

Easy-to-Install and Service

- Easy access service valves on all models
- External high- and low-refrigerant service ports
- Only two screws to access control panel
- Factory charged with R-410A refrigerant

Built to Last

- Baked-on powder coat finish on all sides
- Corrosion protection epoxy phenolic coated aluminum fins
- Coated, weather-resistant cabinet screws
- Coastal coated inlet grille with 3/8" (10mm) grill spacing for extra protection

Warranty*

- Five-year parts limited warranty (including compressor and coil)
 - With timely registration, an additional five-year parts limited warranty (including compressor and coil)

* For residential applications only.
See warranty certificate for complete details and restrictions, including warranty coverage for other applications.

Unit Performance Data

Model Number	Size (tons)	Nominal Btu/hr	Min. Circuit Ampacity	Max. Fuse or Breaker	Operating Dimensions H x W x D (sq) in (mm)	Ship/Operating Weight lbs (kg)
N4A418CKA	1-1/2	18,000	11.7	20	28-7/16 x 23-1/8 x 23-1/8 (722 x 587 x 587)	133/111 (60/50)
N4A424CKA	2	24,000	14.1	25	28-7/16 x 31-3/16 x 31-3/16 (722 x 792 x 792)	170/136 (77/62)
N4A430CKA	2-1/2	30,000	16.8	25	24-13/16 x 31-3/16 x 31-3/16 (630 x 792 x 792)	183/152 (83/69)
N4A436CKA	3	36,000	17.8	30	24-13/16 x 31-3/16 x 31-3/16 (630 x 792 x 792)	185/155 (84/70)
N4A442CKA	3-1/2	42,000	22.3	35	28-7/16 x 31-3/16 x 31-3/16 (722 x 792 x 792)	220/189 (100/86)
N4A448CKA	4	48,000	24.5	40	35-3/4 x 31-3/16 x 31-3/16 (908 x 792 x 792)	233/233 (106/90)
N4A460CKA	5	60,000	31.7	50	39-1/8 x 35 x 35 (993 x 889 x 889)	289/248 (131/113)



NH4A4

14.0 SEER Horizontal Discharge Air Conditioner For Use with Ducted Indoor Units Environmentally Balanced R-410A Refrigerant 1-1/2 – 5 Tons Split System, 208 / 230 Volt, Single-Phase

Refrigeration Circuit

- 14.0 SEER/11.7 - 12.2 EER
- Scroll compressors on all models
- Factory supplied filter drier
- High-pressure switch
- Line lengths up to 250 feet (76.2m)

Easy-to-Install and Service

- Small footprint
- Easy access service valves on all models
- Factory charged with R-410A refrigerant

Built to Last

- Low-ambient operation (down to 0°F/-17.8°C)
- Ball bearing fan motor

Warranty*

- Five-year parts limited warranty (including compressor and coil)
 - With timely registration, an additional five-year parts limited warranty (including compressor and coil)

* For residential applications only.
See warranty certificate for complete details and restrictions, including warranty coverage for other applications.

Unit Performance Data

Model Number	Size (tons)	Nominal Btu/hr	Min. Circuit Ampacity	Max. Fuse or Breaker	Operating Dimensions H x W x D (sq) in (mm)	Ship/Operating Weight lbs (kg)
208/230-1-60						
NH4A418AKA	1-1/2	18,000	11.8	20	31-1/8 x 36-15/16 x 14-9/16 (790 x 938 x 370)	166/146 (75/66)
NH4A424AKA	2	24,000	14.1	25	31-1/8 x 36-15/16 x 14-9/16 (790 x 938 x 370)	168/148 (76/67)
NH4A430AKA	2-1/2	30,000	18.3	30	37-1/8 x 44-1/2 x 17-1/16 (943 x 1130 x 433)	213/183 (97/83)
NH4A436AKA	3	36,000	18.8	30	37-1/8 x 44-1/2 x 17-1/16 (943 x 1130 x 433)	214/184 (97/84)
NH4A448AKA	4	48,000	24.3	40	37-1/8 x 44-1/2 x 17-1/16 (943 x 1130 x 433)	243/213 (110/97)
NH4A460AKA	5	60,000	31.1	50	43-1/8 x 44-1/2 x 17-1/16 (1095 x 1130 x 433)	275/245 (125/111)

N4A3

Efficient 13.0 SEER Air Conditioner Environmentally Balanced R-410A Refrigerant

2 – 5 Tons Split System
208 / 230 Volt, Single-Phase, 60 Hz



Refrigeration Circuit

- Scroll compressors on all models
- Filter drier supplied with every unit for field installation
- Copper tube/aluminum fin coil

Easy-to-Install and Service

- Easy access service valves on all models
- External high- and low-refrigerant service ports
- Only two screws to access control panel
- Factory charged with R-410A refrigerant

Built to Last

- Baked-on powder coat finish over galvanized steel
- Post-painted (black) coil fins
- Coated, weather-resistant cabinet screws
- Coated inlet grille with 2" (51mm) spacing standard, alternate models available with 3/8" (10mm) spacing for extra protection (hail guard)

Warranty*

- Five-year compressor limited warranty
- Five-year parts limited warranty (including compressor and coil)
 - With timely registration, an additional five-year parts limited warranty (including compressor and coil)

* For residential applications only.
See warranty certificate for complete details and restrictions, including warranty coverage for other applications.

Unit Performance Data

Model Number	Size (tons)	Nominal Btu/hr	Min. Circuit Ampacity	Max. Fuse or Breaker	Operating Dimensions H x W x D (sq) in (mm)	Ship/Operating Weight lbs (kg)
N4A318AKF	1-1/2	18,000	11.8	20	25-5/16 x 23-1/8 x 23-1/8 (643 x 587 x 587)	130/107 (59/49)
N4A318GKF	1-1/2	18,000	11.8	20		
N4A324AKG	2	24,000	14.3	25	25-5/16 x 23-1/8 x 23-1/8 (643 x 587 x 587)	127/107 (58/49)
N4A324GKG	2	24,000	14.3	25		
N4A330AKG	2-1/2	30,000	16.6	25	28-11/16 x 25-3/4 x 25-3/4 (729 x 654 x 654)	149/126 (68/57)
N4A330GKG	2-1/2	30,000	16.6	25		
N4A336AKF	3	36,000	18.1	30	25-5/16 x 31-3/16 x 31-3/16 (642 x 792 x 792)	151/134 (68/61)
N4A336GKF	3	36,000	18.1	30		
N4A342AKN	3-1/2	42,000	23.5	40	32-5/16 x 31-3/16 x 31-3/16 (821 x 792 x 792)	218/190 (99/86)
N4A342GKN	3-1/2	42,000	23.5	40		
N4A348AKG	4	48,000	24.3	40	35-1/2 x 31-3/16 x 31-3/16 (901 x 792 x 792)	205/175 (93/79)
N4A348GKG	4	48,000	24.3	40		
N4A360AKN	5	60,000	29.0	50	28-11/16 x 31-3/16 x 31-3/16 (729 x 792 x 792)	232/199 (106/91)
N4A360GKN	5	60,000	29.0	50		

A = 2" (51 mm) spacing inlet grille
G = 3/8" (10 mm) spacing inlet grille



R4A5

Efficient 14.0 SEER/11.7 -12.2 EER Air Conditioner Environmentally Balanced R-410A Refrigerant

1-1/2 – 5 Tons Split System
208 / 230 Volt, Single-Phase 60 Hz

Refrigeration Circuit

- Scroll compressors on all models
- Copper tube/aluminum fin coil

Easy-to-Install and Service

- Easy access service valves on all models
- External high- and low-refrigerant service ports
- Only two screws to access control panel
- Factory charged with R-410A refrigerant

Built to Last

- Pre-painted cabinet finish over galvanized steel
- Coated inlet grille with 2" (51mm) spacing or 3/8" (10mm) spacing for extra protection

Warranty*

- Five-year parts limited warranty (including compressor and coil)
 - With timely registration, an additional five-year parts limited warranty (including compressor and coil)

* For residential applications only. See warranty certificate for complete details and restrictions, including warranty coverage for other applications.

Unit Performance Data

Model Number	Size (tons)	Nominal Btu/hr	Min. Circuit Ampacity	Max. Fuse or Breaker	Operating Dimensions H x W x D (sq) in (mm)	Ship/Operating Weight lbs (kg)
R4A518*KB	1-1/2	18,000	11.7	20	25-5/16 x 25-3/4 x 25-3/4 (642 x 654 x 654)	145/122 (66/55)
R4A524*KB	2	24,000	14.1	20	32-1/16 x 25-3/4 x 25-3/4 (815 x 654 x 654)	148/123 (67/56)
R4A530*KB	2-1/2	30,000	16.8	25	31-11/16 x 31-3/16 x 31-3/16 (804 x 792 x 792)	186/151 (84/69)
R4A536*KB	3	36,000	18.1	30	35-1/16 x 31-3/16 x 31-3/16 (891 x 792 x 792)	171/151 (78/69)
R4A542*KB	3-1/2	42,000	22.3	35	28-1/4 x 31-3/16 x 31-3/16 (718 x 792 x 792)	226/191 (103/87)
R4A548*KB	4	48,000	20.9	35	28-1/4 x 31-3/16 x 31-3/16 (718 x 792 x 792)	200/182 (91/83)
R4A560*KB	5	60,000	27.5	40	31-11/16 x 31-3/16 x 31-3/16 (804 x 792 x 792)	218/197 (99/89)

* A= 2" (51 mm) spacing inlet grille
G = 3/8" (10 mm) spacing inlet grille

R4A4

Efficient 14.0 SEER Air Conditioner Environmentally Balanced R-410A Refrigerant

1-1/2 – 5 Tons Split System
208 / 230 Volt, Single-Phase, 60 Hz



Refrigeration Circuit

- Scroll compressors on all models
- Filter drier supplied with every unit for field installation
- Copper tube/aluminum fin coil

Easy-to-Install and Service

- Easy access service valves on all models
- External high- and low-refrigerant service ports
- Only two screws to access control panel
- Factory charged with R-410A refrigerant

Built to Last

- Pre-painted cabinet finish over galvanized steel
- Coated inlet grille with 2" (51mm) spacing or 3/8" (10mm) spacing for extra protection

Warranty*

- Five-year parts limited warranty (including compressor and coil)
 - With timely registration, an additional five-year parts limited warranty (including compressor and coil)

* For residential applications only. See warranty certificate for complete details and restrictions, including warranty coverage for other applications.

Unit Performance Data

Model Number	Size (tons)	Nominal Btu/hr	Min. Circuit Ampacity	Max. Fuse or Breaker	Operating Dimensions H x W x D (sq) in (mm)	Ship/Operating Weight lbs (kg)
R4A418AKB	1-1/2	18,000	11.7	20	23-7/8 x 23-1/8 x 23-1/8 (632 x 587 x 587)	134/123 (61/56)
R4A418GKB						
R4A424AKB	2	24,000	14.1	20	25-5/16 x 25-3/4 x 25-3/4 (642 x 654 x 654)	140/119 (84/54)
R4A424GKB						
R4A430AKB	2-1/2	30,000	16.8	25	31-11/16 x 31-3/16 x 31-3/16 (804 x 792 x 792)	186/151 (84/68)
R4A430GKB						
R4A436AKB	3	36,000	18.1	30	24-7/8 x 31-3/16 x 31-3/16 (632 x 792 x 792)	151/134 (87/87)
R4A436GKB						
R4A442AKB	3-1/2	42,000	22.3	35	38-7/16 x 31-3/16 x 31-3/16 (977 x 792 x 792)	232/192 (105/87)
R4A442GKB						
R4A448AKB	4	48,000	20.8	35	28-1/4 x 31-3/16 x 31-3/16 (718 x 792 x 792)	200/182 (91/82)
R4A448GKB						
R4A460AKB	5	60,000	27.5	40	31-11/16 x 31-3/16 x 31-3/16 (804 x 792 x 792)	218/197 (99/89)
R4A460GKB						

A = 2" (51 mm) spacing inlet grille
G = 3/8" (10 mm) spacing inlet grille



R4A3

Efficient 13.0 SEER Air Conditioner Environmentally Balanced R-410A Refrigerant

2 – 5 Tons Split System
208 / 230 Volt, Single-Phase, 60 Hz

Refrigeration Circuit

- Scroll compressors on all models
- Copper tube/aluminum fin coil

Easy-to-Install and Service

- Easy access service valves on all models
- External high- and low-refrigerant service ports
- Only two screws to access control panel
- Factory charged with R-410A refrigerant

Built to Last

- Pre-painted cabinet finish over galvanized steel
- Coated inlet grille with 2" (51mm) spacing or 3/8" (10mm) spacing for extra protection

Warranty*

- Five-year parts limited warranty (including compressor and coil)
 - With timely registration, an additional five-year parts limited warranty (including compressor and coil)

* For residential applications only.

See warranty certificate for complete details and restrictions, including warranty coverage for other applications.

Unit Performance Data

Model Number	Size (tons)	Nominal Btu/hr	Min. Circuit Ampacity	Max. Fuse or Breaker	Operating Dimensions H x W x D (sq) in (mm)	Ship/Operating Weight lbs (kg)
R4A318AKH	1-1/2	18,000	11.8	20	24-7/8 x 23-1/8 x 23-1/8 (630 x 587 x 587)	124/108 (56/49)
R4A318GKH	1-1/2	18,000	11.8	20	24-7/8 x 23-1/8 x 23-1/8 (630 x 587 x 587)	124/108 (56/49)
R4A324AKH	2	24,000	14.3	25	24-7/8 x 23-1/8 x 23-1/8 (630 x 587 x 587)	127/107 (58/49)
R4A324GKH	2	24,000	14.3	25	24-7/8 x 23-1/8 x 23-1/8 (630 x 587 x 587)	127/107 (58/49)
R4A330AKH	2-1/2	30,000	16.6	25	28-11/16 x 25-3/4 x 25-3/4 (729 x 654 x 654)	149/126 (68/57)
R4A330GKH	2-1/2	30,000	16.6	25	28-11/16 x 25-3/4 x 25-3/4 (729 x 654 x 654)	149/126 (68/57)
R4A336AKH	3	36,000	18.1	30	24-7/8 x 31-3/16 x 31-3/16 (630 x 792 x 792)	151/134 (68/61)
R4A336GKH	3	36,000	18.1	30	24-7/8 x 31-3/16 x 31-3/16 (630 x 792 x 792)	151/134 (68/61)
R4A342AKH	3-1/2	42,000	23.5	40	31-11/16 x 31-3/16 x 31-3/16 (804 x 792 x 792)	186/172 (85/78)
R4A342GKH	3-1/2	42,000	23.5	40	31-11/16 x 31-3/16 x 31-3/16 (804 x 792 x 792)	186/172 (85/78)
R4A348AKH	4	48,000	24.3	40	35-1/16 x 31-3/16 x 31-3/16 (891 x 792 x 792)	205/175 (93/79)
R4A348GKH	4	48,000	24.3	40	35-1/16 x 31-3/16 x 31-3/16 (891 x 792 x 792)	205/175 (93/79)
R4A360AKH	5	60,000	34.4	50	28-1/4 x 31-3/16 x 31-3/16 (718 x 792 x 792)	218/203 (99/92)
R4A360GKH	5	60,000	34.4	50	28-1/4 x 31-3/16 x 31-3/16 (718 x 792 x 792)	218/203 (99/92)

A = 2" (51 mm) spacing inlet grille
G = 3/8" (10 mm) spacing inlet grille

Accessories

Residential Air Conditioners

CSA6, CSA5, C4A3, NXA4, NXA6, N4A3, N4A4, N4A5, N4A6, R4A5, R4A4, R4A3 (R-410A Air Conditioner)			
Part Number	Description	Used on Model Size	
NASA001CH	Crankcase Heater for Scroll Compressor (208/230 V)	C4A3	42, 48, 60
		CSA5	42
		CSA6	42, 48, 60
		N4A3	36, 42, 48, 60
		N4A4	42, 48
		N4A5	42, 48, 60
		N4A6	42, 48, 60
		NXA4	42, 48, 60
		NXA6	42, 48, 49, 60, 61
		R4A5	42, 48, 60
		R4A4	42, 48, 60
		R4A3	36, 42, 48, 60
NASA003CH	Crankcase Heater for Scroll Compressor (208/230 V) (factory installed on some models)	C4A3	18, 24, 30, 36
		CSA6	18, 24, 30, 36
		CSA5	24, 30, 36
		N4A5	24, 30, 36
		N4A3	ALL
		C4A3	ALL
		N4A4	18, 24, 30, 36
		N4A6	18, 24, 30, 36
		NXA4	18, 24, 30, 36
		NXA6	18, 24, 30, 36
		R4A4	18, 24, 30
		R4A5	18, 24, 30, 36
NASA00501CH	Crankcase Heater for Scroll Compressor (208/230 V)	CSA5	48, 60
NASA003SC	Hard Start Kit	C4A3	ALL
		N4A3	ALL
		N4A4	42
		R4A3	ALL
NASA005SC	Hard Start Kit	N4A5	ALL
		N4A4	18, 24, 36, 48, 60
NASA014SC	Hard Start Kit	CSA6	ALL
		CSA5	ALL
TSTAT0201CW	Observer® Self-Configuring Communication Wall Control	CSA6	ALL
		CSA5	ALL
NASA001SJ	Sound Jacket, Compressor (factory installed on some models)	N4A3	18, 24, 30, 36, 42, 48
		N4A4	18, 24, 30, 36, 42, 48
		N4A6	18, 24, 30, 36, 42, 48
		N4A5	18, 24, 30, 36, 42, 48
		NXA4	42, 48
		NXA6	18, 24, 30, 36, 42, 48, 49
		R4A3	18, 24, 30, 36, 42, 48
		R4A4	42, 48
R4A5	18, 24, 30, 36, 42, 48		

Accessories

Residential Air Conditioners

CSA6, CSA5, C4A3, CXA4, CXA6, N4A3, N4A4, N4A5, N4A6, R4A5, R4A4, R4A3 (R-410A Air Conditioner)			
Part Number	Description	Used on Model Size	
NASA003SJ	Sound Jacket, Compressor (factory installed on some models)	N4A3	60
		N4A4	60
		N4A6	60
		N4A5	60
		NXA4	60
		NXA6	60, 61
		R4A3	60
		R4A4	60
		R4A5	60
NASA002SJ	Sound Jacket, Compressor	NXA4	18, 24, 30
		R4A4	18, 24, 30
NAEA40501TX	TXV Kit, R-410A – for use with copper or tin fan coils	ALL	18, 24, 30
NAEA40601TX	TXV Kit, R-410A – for use with copper or tin fan coils	ALL	36, 42
NAEA40701TX	TXV Kit, R-410A – for use with copper or tin fan coils	ALL	48, 49, 60, 61
NAEB40501TX	TXV Kit, R-410A – for use with aluminum fan coils	ALL	18, 24, 30
NAEB40601TX	TXV Kit, R-410A – for use with aluminum fan coils	CSA5	36
		ALL	36, 42
NAEB40701TX	TXV Kit, R-410A – for use with aluminum fan coils	CSA5	42, 48, 60
		ALL	48, 49, 60, 61
NASA001SC	Start Component – PTC Deluxe	ALL	
NASA00201FS	Evaporator Freeze Thermostat	ALL	
NASA403PS	Low-Pressure Switch, AC, R-410A (factory installed on some models)	ALL	
NASA404PS	High-Pressure Switch, AC or HP, R-410A (factory installed on some models)	ALL	
NASA401LS	Liquid Line Solenoid Valve, R-410A	ALL	
NASA001TD	Time Delay Relay, Indoor Blower	ALL	
NASA00201WS	Winter Start Control	ALL	
NASA001WS	Winter Start Control	ALL	
NASA001AC	Anti-Cycle Timer (5-minute delay)	ALL	
NASA401LA	Low-Ambient Pressure Switch	ALL	
NASA001SF	Support Feet, 4" (102 mm) tall (4 blocks)	N4A3	42, 48, 60
		N4A4	24, 30, 42, 48, 60
		N4A6	30, 42, 48, 60
		N4A5	42, 48, 60
		H4A3	30, 42, 48, 60
		R4A5	42, 48, 60
		N4A3	30, 36
NASA00201SF	Support Feet, 4" (102 mm) tall (5 blocks)	N4A4	18
		N4A6	18, 30, 36
		N4A5	18, 30, 36
		NXA4	ALL
		CSA5	ALL
		H4A3	18, 24, 36
		R4A5	18, 24, 36
		R4A5	18, 24, 36

Accessories Residential Air Conditioners

N4A7 (Two-Stage Air Conditioner)		
Part Number	Description	Used on Model Size
NASA00601CH	Crankhouse Heater for Scroll Compressor	24, 36
NASA001SC	Start Component - PTC Device	ALL
NASA00201FS	Evaporator Freeze Thermostat	ALL
NASA401LS	Liquid Line Solenoid Valve, R-410A	ALL
NASA001TD	Time Delay Relay, Indoor Blower	ALL
NASA00201WS	Winter Start Control	ALL
NASA001AC	Anti-Cycle Timer (5-minute delay)	ALL
NASA012SC	Hard Start Kit (capacitor and relay)	ALL
NASA401LA	Low-Ambient Kit (pressure switch), R-410A	ALL
NASA001SF	Support Feet, 4" (102 mm) tall	42
NASA00201SJ	Sound Jacket Compressor	24, 36
NASA00101SJ	Sound Jacket Compressor	48, 60
NAEA40501TX	TXV Kit, R-410A - for use with copper or tin fan coils	24
NAEA40601TX	TXV Kit, R-410A - for use with copper or tin fan coils	36
NAEA40701TX	TXV Kit, R-410A - for use with copper or tin fan coils	48, 60
NAEB40501TX	TXV Kit, R-410A - for use with aluminum fan coils	24
NAEB40601TX	TXV Kit, R-410A - for use with aluminum fan coils	36
NAEB40701TX	TXV Kit, R-410A - for use with aluminum fan coils	48, 60
HCA724-60GKA2/B1 (R-410A Two-Stage Communicating Air Conditioner)		
Part Number	Description	Used on Model Size
TSTAT0201CW	Observer® Self-Configuring Communicating Wall Control	ALL
NASA401LS	Liquid Line Solenoid Valve, R-410A	ALL
NASA001TD	Time Delay Relay, Indoor Blower	ALL
NASA001SF	Support Feet, 4" (102 mm) tall (4 blocks)	
NASA00201SF	Support Feet, 4" (102 mm) tall (5 blocks)	ALL
NASA012SC	Hard Start Kit	24, 36
NASA013SC	Hard Start Kit	48, 60
NASA00201FS	Evaporator Freeze Thermostat	ALL
NASA00201WS	Winter Start Control	ALL
NASA401LA	Low-Ambient Pressure Kit	ALL
NASA01001CH	Crankcase Heater for Scroll Compressor (208/230 V) (factory installed on 48 and 60)	24, 36
HVA9 (R-410A Five-Stage Communicating Air Conditioner)		
Part Number	Description	Used on Model Size
TSTAT0201CW	Observer® Self-Configuring Communicating Wall Control	ALL
NASA00106SS	Snow Stand Kit	60
NASA001SF	Support Feet, 4" (102 mm) tall (4 blocks)	ALL
NASA00201SF	Support Feet, 4" (102 mm) tall (5 blocks)	ALL
NAEA40501TX	TXV Kit, R-410A for use on copper or tin fin coils	24, 25
NAEA40601TX	TXV Kit, R-410A for use on copper or tin fin coils	36, 37
NAEA40701TX	TXV Kit, R-410A for use on copper or tin fin coils	48, 49, 60
NAEB40501TX	TXV Kit, R-410A for use on aluminum fin coils	24, 25
NAEB40601TX	TXV Kit, R-410A for use on aluminum fin coils	36, 37
NAEB40701TX	TXV Kit, R-410A for use on aluminum fin coils	48, 49, 60
1187979	Vapor Line Muffler (FAST Parts)	ALL

Some accessories may be factory installed. Refer to product specifications for exact accessory match.

Accessories

Residential Ducted Horizontal Air Conditioner – NH4A4

Kit Number	Description	Unit Size (Voltage/Series)											
		18	24	30	36	36	36	48	48	48	60	60	60
		AKA	AKA	AKA	AKA	AHA	ALA	AKA	AHA	ALA	AKA	AHA	ALA
NASA003CH	Crankcase Heater	X	X	X	X	X							
NASA001CH	Crankcase Heater							X	X		X	X	
NASA004CH	Crankcase Heater						X						
NASA00301CH	Crankcase Heater									X			X
NASA00201FS	Evaporator Freeze Stat	X	X	X	X	X	X	X	X	X	X	X	X
NASA001TD	Time Delay Relay	X	X	X	X	X	X	X	X	X	X	X	X
NASA00201WS	Winter Start Control	X	X	X	X	X	X	X	X	X	X	X	X
NASA401LA	Low-Ambient Kit	X	X	X	X	X	X	X	X	X	X	X	X
NASA00201WB	Wind Baffle	X	X										
NASA00301WB	Wind Baffle			X	X	X	X	X	X	X			
NASA00401WB	Wind Baffle										X	X	X
NASA00101SG	Stacking Kit	X	X										
NASA00201SG	Stacking Kit			X	X	X	X	X	X	X	X	X	X
NASA00101WM	Wall Mounting Kit	X	X										
NASA00201WM	Wall Mounting Kit			X	X	X	X	X	X	X	X	X	X
NASA404PS	Low-Pressure Switch Kit	X	X	X	X	X	X	X	X	X	X	X	X
1177810	Sound Blanket Kit							X	X	X	X	X	X
NASA401LS	Solenoid Valve Kit	X	X	X	X	X	X	X	X	X	X	X	X
NASA003SC	Capacitor Relay Start Assist	X	X	X	X			X			X		

Residential Heat Pumps



CVH8

High-Efficiency up to 19.0 SEER Variable-Speed Heat Pump with Observer® Communicating Control System

2 – 5 Tons Split System
208 / 230 Volt, Single-Phase, 60 Hz



Recommended
(Sold separately)



Refrigeration Circuit

- Variable-speed compressor operates at five stages with capacity range as wide as 25 - 100%
- Electronic expansion valve (EXV) for precise heating control
- High-pressure switch
- Suction pressure transducer
- Pressure equalizer valve for easy starting
- Compressor discharge temperature sensor
- Coil temperature sensor
- Copper tube/aluminum fin coil
- Internal crankcase heater standard
- Suction line accumulator factory installed

Built to Last

- High-gloss, baked-on powder coat finish over galvanized steel
- Post-painted (black) coil fins
- Coated inlet grille with 3/8" (10mm) spacing for extra protection (hail guard)
- Corner posts for extra strength and style

Performance

- Up to 13.0 EER and 11.0 HSPF
- Integrated inverter control enables five-stage operation with Observer Communicating System with version 5.0 or newer software required for five-stage operation
- Also capable of two-stage operation with two-stage thermostat
- Self-configuring installation with Observer Communicating Wall Control
- Compact ECM fan motor driven by integrated inverter control
- Outdoor temperature sensor factory installed
- High performance compressor sound shield standard
- Isolation compressor grommets
- Enhanced dehumidification

Warranty*

- 10-year No Hassle Replacement™ limited warranty
- Five-year parts limited warranty (including compressor and coil)
 - With timely registration, an additional five-year parts limited warranty (including compressor and coil)

* For residential applications only. See warranty certificate for complete details and restrictions, including warranty coverage for other applications.

Easy-to-Install and Service

- Text based diagnostics with Observer Communicating Wall Control
- Only two control wires required from communicating indoor unit to condenser
- External high- and low-refrigerant service ports
- Factory charged with R-410A refrigerant
- Adjustments for min. and max. staging with Observer Communicating Wall Control



Qualifying models only.

Unit Performance Data

Model Number	Size (tons)	Nominal Btu/hr	Min. Circuit Ampacity	Max. Fuse or Breaker	Operating Dimensions H x L x W (sq) in (mm)	Ship/Operating Weight lbs (kg)
CVH824GKA	2	24,000	13.5	20	31-13/16 x 23-1/8 x 23-1/8 (807 x 587 x 587)	154/132 (70/60)
CVH825GKA†	2	24,000	23.6	40	38-1/2 x 23-1/8 x 23-1/8 (980 x 587 x 587)	181/156 (82/71)
CVH836GKA	3	36,000	24.4	40	38-1/2 x 23-1/8 x 23-1/8 (980 x 587 x 587)	181/156 (82/71)
CVH837GKA†	3	36,000	26.0	40	38-15/16 x 31-3/16 x 31-3/16 (989 x 242 x 242)	244/207 (111/94)
CVH848GKA	4	48,000	31.4	50	38-15/16 x 31-3/16 x 31-3/16 (989 x 792 x 792)	244/207 (111/94)
CVH860GKA	5	60,000	40.8	60	42-5/16 x 31-3/16 x 31-3/16 (1075 x 792 x 792)	272/233 (123/106)

† Meets ENERGY STAR® criteria when matched with appropriate coil.



Recommended
(Sold separately)

CCH6

High-Efficiency up to 16.0 SEER Two-Stage Heat Pump with Observer® Communicating Control System

2 – 5 Tons Split System
208 / 230 Volt, Single-Phase, 60 Hz

Refrigeration Circuit

- Copeland Scroll™ UltraTech™ compressors on all models
- Crankcase heater factory installed
- Suction line accumulator factory installed
- Bi-flow filter drier supplied with every unit for field installation
- Integrated solid-state control with Time-Temperature Defrost
- High- and low-pressure switches
- Discharge gas thermostat
- Copper tube/aluminum fin coil

Built to Last

- High-gloss, baked-on powder coat finish over galvanized steel
- Post-painted (black) coil fins
- Coated, weather-resistant cabinet screws
- Coated inlet grille with 3/8" (10mm) spacing for extra protection (hail guard)
- Corner posts for extra strength and style

Performance

- Communicating, self-configuring operation when used with Observer Communicating Wall Control
- Outdoor temperature sensor factory installed
- Ball bearing PSC fan motors on all models
- High performance compressor sound shield standard
- Isolation compressor grommets

Warranty*

- 10-year No Hassle Replacement™ limited warranty
- Five-year parts limited warranty (including compressor and coil)
 - With timely registration, an additional five-year parts limited warranty (including compressor and coil)

* For residential applications only. See warranty certificate for complete details and restrictions, including warranty coverage for other applications.

Easy-to-Install and Service

- Text based diagnostics with Observer Communicating Wall Control
- Only two control wires required from communicating indoor unit to condenser
- Easy access service valves on all models
- Innovative control box design
- External high- and low-refrigerant service ports
- Only two screws to access control panel
- Factory charged with R-410A refrigerant



Unit Performance Data

Model Number	Size (tons)	Nominal Btu/hr	Min. Circuit Ampacity	Max. Fuse or Breaker	Operating Dimensions H x W x D (sq) in (mm)	Ship/Operating Weight lbs (kg)
CCH624GKA1	2	24,000	16.4	25	40-1/8 x 35 x 35 (1019 x 889 x 889)	292/249 (132/113)
CCH624GKA3	2	24,000	16.2	25	40-1/8 x 35 x 35 (1019 x 889 x 889)	292/249 (132/113)
CCH636GKA1	3	36,000	21.8	35	43-1/2 x 35 x 35 (1105 x 889 x 889)	313/270 (142/123)
CCH636GKA2	3	36,000	23.7	40	40-1/8 x 35 x 35 (1019 x 889 x 889)	313/270 (142/123)
CCH648GKA1	4	48,000	34.8	50	46-7/8 x 35 x 35 (1191 x 889 x 889)	345/302 (157/137)
CCH648GKA2	4	48,000	29.8	50	40-1/8 x 35 x 35 (1019 x 889 x 889)	345/302 (157/137)
CCH660GKA1	5	60,000	30.1	50	46-7/8 x 35 x 35 (1191 x 889 x 889)	369/323 (167/147)
CCH660GKA2	5	60,000	37.5	60	46-7/8 x 35 x 35 (1191 x 889 x 889)	369/323 (167/147)

CSH6

16.0 SEER Single-Stage Heat Pump with Observer® Communicating Control System

1-1/2 – 5 Tons Split System
208 / 230 Volt, Single-Phase, 60 Hz



Recommended
(Sold separately)



Refrigeration Circuit

- Scroll compressors on all models
- Suction line accumulator factory installed
- Bi-flow filter drier supplied with every unit for field installation
- Integrated solid-state control with Time-Temperature Defrost
- External high- and low-refrigerant service ports
- Copper tube/aluminum fin coil

Performance

- Communicating, self-configuring operation when used with Observer Communicating Wall Control
- Outdoor temperature sensor factory installed
- Compressor sound blanket standard
- Isolation compressor grommets

Easy-to-Install and Service

- Text based diagnostics with Observer Communicating Wall Control
- Easy access service valves on all models
- Innovative control box design
- High- and low-pressure switches
- Only two screws to access control panel
- Factory charged with R-410A refrigerant

Built to Last

- High-gloss, baked-on powder coat finish over galvanized steel
- Post-painted (black) coil fins
- Coated, weather-resistant cabinet screws
- Coated inlet grille with 3/8" (10mm) spacing for extra protection (hail guard)
- Corner posts for extra strength and style

Warranty*

- Five-year No Hassle Replacement™ limited warranty (when installed with Observer Wall Control)
- Five-year parts limited warranty (including compressor and coil)
 - With timely registration, an additional five-year parts limited warranty (including compressor and coil)

* For residential applications only. See warranty certificate for complete details and restrictions, including warranty coverage for other applications.



Unit Performance Data

Model Number	Size (tons)	Nominal Btu/hr	Min. Circuit Ampacity	Max. Fuse or Breaker	Operating Dimensions H x W x D (sq) in (mm)	Ship/Operating Weight lbs (kg)
CSH618GKA	1-1/2	18,000	13.6	20	31-3/16 x 31-3/16 x 35-1/2 (793 x 793 x 902)	213/181 (97/82)
CSH624GKA	2	24,000	15.5	25	35 x 35 x 33-5/8 (889 x 889 x 854)	232/194 (105/88)
CSH630GKA	2-1/2	30,000	19.9	30	35 x 35 x 33-5/8 (889 x 889 x 854)	267/229 (121/104)
CSH636GKA	3	36,000	21.6	35	35 x 35 x 33-5/8 (889 x 889 x 854)	275/237 (125/108)
CSH642GKA	3-1/2	42,000	27.8	40	35 x 35 x 33-5/8 (889 x 889 x 854)	293/255 (133/116)
CSH648GKA	4	48,000	31.8	45	35 x 35 x 33-5/8 (889 x 889 x 854)	298/260 (135/118)
CSH660GKA	5	60,000	33.9	50	35 x 35 x 47-3/16 (889 x 889 x 1199)	363/317 (165/144)



Recommended
(Sold separately)

CSH5

Up to 15.0 SEER Single-Stage Heat Pump with Observer® Communicating Control System

1-1/2 – 5 Tons Split System
208 / 230 Volt, Single-Phase, 60 Hz

Refrigeration Circuit

- Scroll compressors on all models
- Suction line accumulator factory installed
- Bi-flow filter drier supplied with every unit for field installation
- Integrated solid-state control with Time-Temperature Defrost
- External high- and low-refrigerant service ports
- Copper tube/aluminum fin coil

Performance

- Communicating, self-configuring operation when used with Observer Communicating Wall Control
- Outdoor temperature sensor factory installed
- Compressor sound blanket standard
- Isolation compressor grommets

Easy-to-Install and Service

- Text based diagnostics with Observer Communicating Wall Control
- Easy access service valves on all models
- Innovative control box design
- High- and low-pressure switches
- Only two screws to access control panel
- Factory charged with R-410A refrigerant

Built to Last

- High-gloss, baked-on powder coat finish over galvanized steel
- Post-painted (black) coil fins
- Coated, weather-resistant cabinet screws
- Coated inlet grille with 3/8" (10mm) spacing for extra protection (hail guard)
- Corner posts for extra strength and style

Warranty*

- Five-year No Hassle Replacement™ limited warranty
- Five-year parts limited warranty (including compressor and coil)
 - With timely registration, an additional five-year parts limited warranty (including compressor and coil)

* For residential applications only. See warranty certificate for complete details and restrictions, including warranty coverage for other applications.



Unit Performance Data

Model Number	Size (tons)	Nominal Btu/hr	Min. Circuit Ampacity	Max. Fuse or Breaker	Operating Dimensions H x W x D (sq) in (mm)	Ship/Operating Weight lbs (kg)
CSH518GKA	1-1/2	18,000	11.8	20	28-9/16 x 31-3/16 x 31-3/16 (726 x 792 x 792)	219/184 (99/83)
CSH524GKA	2	24,000	16.5	25	33-5/16 x 35 x 35 (846 x 889 x 889)	257/215 (117/98)
CSH530GKA	2-1/2	30,000	18.1	30	33-5/16 x 35 x 35 (846 x 889 x 889)	259/218 (117/99)
CSH536GKA	3	36,000	22.1	35	36-11/16 x 35 x 35 (932 x 889 x 889)	273/230 (124/104)
CSH542GKA	3-1/2	42,000	27.6	40	29-7/8 x 35 x 35 (760 x 889 x 889)	305/263 (135/119)
CSH548GKA	4	48,000	28.5	40	33-5/16 x 35 x 35 (846 x 889 x 889)	323/279 (146/126)
CSH560GKA	5	60,000	34.2	50	40-1/8 x 35 x 35 (1019 x 889 x 889)	357/314 (162/142)

CSH4

14.0 SEER Single-Stage Heat Pump with Observer® Communicating Control System

1-1/2 – 5 Tons Split System
208 / 230 Volt, Single-Phase, 60 Hz



Recommended
(Sold separately)



Refrigeration Circuit

- Copeland Scroll™ UltraTech™ compressors on all models
- Suction line accumulator factory installed
- Bi-flow filter drier supplied with every unit for field installation
- Integrated solid-state control with Time-Temperature Defrost
- External high- and low-refrigerant service ports
- Copper tube/aluminum fin coil

Built to Last

- High-gloss, baked-on powder coat finish over galvanized steel
- Post-painted (black) coil fins
- Coated, weather-resistant cabinet screws
- Coated inlet grille with 3/8" (10mm) spacing for extra protection (hail guard)
- Corner posts for extra strength and style

Performance

- Communicating, self-configuring operation when used with Observer Communicating Wall Control
- Outdoor temperature sensor factory installed
- Compressor sound blanket standard
- Isolation compressor grommets

Warranty*

- Three-year No Hassle Replacement™ limited warranty
- Five-year parts limited warranty (including compressor and coil) – With timely registration, an additional five-year parts limited warranty (including compressor and coil)

* For residential applications only. See warranty certificate for complete details and restrictions, including warranty coverage for other applications.

Easy-to-Install and Service

- Text based diagnostics with Observer Communicating Wall Control
- Easy access service valves on all models
- Innovative control box design
- High- and low-pressure switches
- Only two screws to access control panel
- Factory charged with R-410A refrigerant



Unit Performance Data

Model Number	Size (tons)	Nominal Btu/hr	Min. Circuit Ampacity	Max. Fuse or Breaker	Operating Dimensions H x W x D (sq) in (mm)	Ship/Operating Weight lbs (kg)
CSH418GKA	1-1/2	18,000	11.8	20	28-11/16 x 31-3/16 x 31-3/16 (729 x 793 x 793)	219/184 (99/84)
CSH424GKA	2	24,000	17.6	25	28-11/16 x 31-3/16 x 31-3/16 (729 x 793 x 793)	195/164 (89/73)
CSH430GKA	2-1/2	30,000	18.3	30	28-11/16 x 31-3/16 x 31-3/16 (729 x 793 x 793)	216/182 (98/83)
CSH436GKA	3	36,000	20.0	30	28-11/16 x 31-3/16 x 31-3/16 (729 x 793 x 793)	228/194 (103/88)
CSH442GKA	3-1/2	42,000	24.0	40	28-11/16 x 31-3/16 x 31-3/16 (729 x 793 x 793)	252/221 (114/100)
CSH448GKA	4	48,000	25.2	40	28-11/16 x 31-3/16 x 31-3/16 (729 x 793 x 793)	252/221 (114/100)
CSH460GKA	5	60,000	32.0	50	28-11/16 x 31-3/16 x 31-3/16 (729 x 793 x 793)	267/236 (121/107)



N4H6

**Efficient Up to 17.5 SEER Heat Pump
Environmentally Balanced R-410A Refrigerant**

**2 – 5 Tons Split System
208 / 230 Volt, Single-Phase**

Refrigeration Circuit

- Two-stage scroll compressors on all models
- Suction line accumulator factory installed
- Bi-flow filter drier included for field installation
- Integrated solid state control with Time-Temperature Defrost
- High- and low-pressure switches
- Copper tube/aluminum fin coil

Built to Last

- Baked-on powder coat finish over galvanized steel
- Post-painted (black) coil fins
- Coated, weather-resistant cabinet screws
- Coated inlet grille with 3/8" (10mm) spacing for extra protection

Easy-to-Install and Service

- Easy access service valves on all models
- External high- and low-refrigerant service ports
- Only two screws to access control panel
- Factory charged with R-410A refrigerant

Warranty*

- Five-year compressor limited warranty (including compressor and coil)
 - With timely registration, an additional five-year parts limited warranty (including compressor and coil)

* For residential applications only. See warranty certificate for complete details and restrictions, including warranty coverage for other applications.

Unit Performance Data

Model Number	Size (tons)	Nominal Btu/hr	Min. Circuit Ampacity	Max. Fuse or Breaker	Operating Dimensions H x W x D (sq) in (mm)	Ship/Operating Weight lbs (kg)
N4H624GKA	2	24,000	16.2	25	38-7/8 x 35 x 35 (988 x 889 x 889)	277/233 (126/106)
N4H636GKA	3	36,000	23.7	40	38-7/8 x 35 x 35 (988 x 889 x 889)	289/245 (131/111)
N4H648GKA	4	48,000	29.5	50	38-7/8 x 35 x 35 (988 x 889 x 889)	315/271 (143/123)
N4H660GKA	5	60,000	37.5	60	45-11/16 x 35 x 35 (1161 x 889 x 889)	340/294 (154/133)

NXH6

High-Efficiency 16.0 SEER Heat Pump Environmentally Balanced R-410A Refrigerant

1-1/2 – 5 Tons Split System
208 / 230 Volt, Single-Phase, 60 Hz



Refrigeration Circuit

- Scroll compressors on all models
- Suction line accumulator factory installed
- Bi-flow filter drier included for field installation
- Integrated solid-state control with Time-Temperature Defrost
- High- and low-pressure switches
- Copper tube/aluminum fin coil

Easy-to-Install and Service

- Easy access service valves on all models
- External high- and low-refrigerant service ports
- Only two screws to access control panel
- Factory charged with R-410A refrigerant

Built to Last

- Baked-on powder coat finish over galvanized steel
- Post-painted (black) coil fins
- Coated, weather-resistant cabinet screws
- Coated inlet grille with 3/8" (10mm) spacing for extra protection (hail guard)

Warranty*

- Five-year parts limited warranty (including compressor and coil)
 - With timely registration, an additional five-year parts limited warranty (including compressor and coil)

* For residential applications only. See warranty certificate for complete details and restrictions, including warranty coverage for other applications.



Unit Performance Data

Model Number	Size (tons)	Nominal Btu/hr	Min. Circuit Ampacity	Max. Fuse or Breaker	Operating Dimensions H x W x D (sq) in (mm)	Ship/Operating Weight lbs (kg)
NXH618GKA	1-1/2	18,000	13.6	20	35-1/2 x 31-3/16 x 31-3/16 (901 x 793 x 793)	199/167 (90/76)
NXH624GKA	2	24,000	15.5	25	32-1/16 x 35 x 35 (815 x 889 x 889)	210/172 (95/78)
NXH630GKA	2-1/2	30,000	19.9	30	32-1/16 x 35 x 35 (815 x 889 x 889)	245/207 (111/94)
NXH636GKA	3	36,000	21.6	35	32-1/16 x 35 x 35 (815 x 889 x 889)	253/215 (115/98)
NXH642GKA	3-1/2	42,000	27.8	40	32-1/16 x 35 x 35 (815 x 889 x 889)	271/233 (123/106)
NXH648GKA	4	48,000	31.8	45	32-1/16 x 35 x 35 (815 x 889 x 889)	276/238 (125/108)
NXH660GKA	5	60,000	33.9	50	45-11/16 x 35 x 35 (1161 x 889 x 889)	334/288 (152/131)



NXH5

High-Efficiency Up to 15.0 SEER Heat Pump Environmentally Balanced R-410A Refrigerant

1-1/2 – 5 Tons Split System
208 / 230 Volt, Single-Phase, 60 Hz

Refrigeration Circuit

- Scroll compressors on all models
- Suction line accumulator factory installed
- Bi-flow filter drier included for field installation
- Integrated solid-state control with Time-Temperature Defrost
- High- and low-pressure switches
- Copper tube/aluminum fin coil

Easy-to-Install and Service

- Easy access service valves on all models
- External high- and low-refrigerant service ports
- Only two screws to access control panel
- Factory charged with R-410A refrigerant

Built to Last

- Baked-on powder coat finish over galvanized steel
- Post-painted (black) coil fins
- Coated, weather-resistant cabinet screws
- Coated inlet grille with 3/8" (10mm) spacing for extra protection (hail guard)

Warranty*

- Five-year parts limited warranty (including compressor and coil)
 - With timely registration, an additional five-year parts limited warranty (including compressor and coil)

* For residential applications only. See warranty certificate for complete details and restrictions, including warranty coverage for other applications.



Unit Performance Data

Model Number	Size (tons)	Nominal Btu/hr	Min. Circuit Ampacity	Max. Fuse or Breaker	Operating Dimensions H x W x D (sq) in (mm)	Ship/Operating Weight lbs (kg)
NXH518GKA	1-1/2	18,000	11.8	20	28-15/16 x 31-3/16 x 31-3/16 (735 x 792 x 792)	207/169 (94/77)
NXH524GKA	2	24,000	16.5	25	32-5/16 x 35 x 35 (821 x 889 x 889)	233/200 (106/91)
NXH530GKA	2-1/2	30,000	18.1	30	32-5/16 x 35 x 35 (821 x 889 x 889)	242/196 (110/89)
NXH536GKA	3	36,000	22.1	35	35-3/4 x 35 x 35 (908 x 889 x 889)	257/215 (117/98)
NXH537GKA	3	36,000	22.1	35	35-3/4 x 35 x 35 (908 x 889 x 889)	297/255 (135/116)
NXH542GKA	3-1/2	42,000	27.6	40	28-15/16 x 35 x 35 (735 x 889 x 889)	290/245 (132/111)
NXH548GKA	4	48,000	28.5	40	28-15/16 x 35 x 35 (735 x 889 x 889)	303/260 (137/118)
NXH560GKA	5	60,000	34.2	50	39-1/8 x 35 x 35 (994 x 889 x 889)	345/294 (157/133)

N4H4

Efficiency 14.0 SEER Heat Pump Environmentally Sound R-410A Refrigerant



1-1/2 – 5 Tons Split System
208 / 230 Volt, Single-Phase, 60 Hz

Refrigeration Circuit

- Scroll compressors on all models
- Suction line accumulator factory installed
- Integrated solid state control with Time-Temperature Defrost
- High- and low-pressure switches
- Copper tube/aluminum fin coil

Easy-to-Install and Service

- Easy access service valves on all models
- External high- and low-refrigerant service ports
- Only two screws to access control panel
- Factory charged with R-410A refrigerant

Built to Last

- Painted cabinet finish over galvanized steel
- Models available with coated inlet grille with 3/8" (10mm) spacing grille

Warranty*

- Five-year compressor limited warranty (including compressor and coil)
 - With timely registration, an additional five-year parts limited warranty (including compressor and coil)

* For residential applications only. See warranty certificate for complete details and restrictions, including warranty coverage for other applications.

Unit Performance Data

Model Number	Size (tons)	Nominal Btu/hr	Min. Circuit Ampacity	Max. Fuse or Breaker	Operating Dimensions H x W x D (sq) in (mm)	Ship/Operating Weight lbs (kg)
N4H418GKG	1-1/2	18,000	11.8	20	35-1/4 x 23-1/8 x 23-1/8 (899 x 587 x 587)	166/136 (75/61)
N4H424GKG	2	24,000	14.2	25	35-1/4 x 25-3/4 x 25-3/4 (895 x 654 x 654)	175/144 (79/65)
N4H430GKG	2-1/2	30,000	16.9	30	31-13/16 x 31-3/16 x 31-3/16 (808 x 792 x 792)	180/158 (82/72)
N4H436GKG	3	36,000	20.0	30	28-7/16 x 31-3/16 x 31-3/16 (722 x 792 x 792)	201/170 (91/77)
N4H442GKG	3-1/2	42,000	24.0	40	39-1/8 x 31-3/16 x 31-3/16 (994 x 792 x 792)	235/201 (107/91)
N4H448GKG	4	48,000	25.2	40	28-7/16 x 31-3/16 x 31-3/16 (722 x 792 x 792)	232/197 (105/89)
N4H460GKG	5	60,000	32.0	50	31-13/16 x 31-3/16 x 31-3/16 (808 x 792 x 792)	248/212 (113/96)



N4H4-C

**Coastal 14.0 SEER Heat Pump
14.0 SEER/11.5-11.7 EER/8.2 HSPF R-410A Refrigerant**

**2 – 5 Tons Split System
208 / 230 Volt, Single-Phase, 60 Hz**

Refrigeration Circuit

- Scroll compressors on all models
- Suction line accumulator factory installed
- Bi-flow filter drier included for field installation
- Integrated solid-state control with Time-Temperature Defrost
- High- and low-pressure switches
- Copper tube/aluminum fin coil

Built to Last

- Baked-on powder coat finish on all sides
- Corrosion protection epoxy phenolic coated aluminum fins
- Coated, weather-resistant cabinet screws
- Coated inlet grille with 3/8" (10mm) spacing for extra protection (hail guard)

Easy-to-Install and Service

- Easy access service valves on all models
- External high- and low-refrigerant service ports
- Only two screws to access control panel
- Factory charged with R-410A refrigerant

Warranty*

- Five-year compressor limited warranty (including compressor and coil)
 - With timely registration, an additional five-year parts limited warranty (including compressor and coil)

* For residential applications only. See warranty certificate for complete details and restrictions, including warranty coverage for other applications.

Unit Performance Data

Model Number	Size (tons)	Nominal Btu/hr	Min. Circuit Ampacity	Max. Fuse or Breaker	Operating Dimensions H x W x D (sq) in (mm)	Ship/Operating Weight lbs (kg)
N4H418CKG	1-1/2	18,000	12.4	20	35-3/4 x 25-3/4 x 25-3/4 (895 x 654 x 654)	162/136 (73/61)
N4H424CKG	2	24,000	14.7	25	38-7/8 x 31-3/16 x 31-3/16 (988 x 792 x 792)	195/160 (89/72)
N4H430CKG	2-1/2	30,000	18.3	30	28-7/16 x 31-3/16 x 31-3/16 (722 x 792 x 792)	196/162 (89/73)
N4H436CKG	3	36,000	21.5	35	32-1/16 x 31-3/16 x 31-3/16 (815 x 792 x 792)	225/189 (102/86)
N4H442CKG	3-1/2	42,000	31.2	50	28-7/16 x 31-3/16 x 31-3/16 (722 x 792 x 792)	237/203 (108/92)
N4H448CKG	4	48,000	28.0	40	35-1/2 x 31-3/16 x 31-3/16 (901 x 792 x 792)	259/223 (117/101)
N4H460CKG	5	60,000	32.5	50	38-7/8 x 31-3/16 x 31-3/16 (988 x 792 x 792)	269/233 (122/106)

NH4H4

**14.0 SEER Horizontal Discharge Heat Pump
For Use with Ducted Indoor Units
Environmentally Sound R-410A Refrigerant
1-1/2 – 5 Tons Split System, 208 / 230 Volt, Single-Phase**



Refrigeration Circuit

- 14.0-16.0 SEER/11.0-13.0 EER/8.2-9.0 HSPF
- Scroll compressors on all models
- Factory-supplied filter-drier
- High- and low-pressure switches
- Line lengths up to 250 feet (76.2m)
- Accumulator

Easy-to-Install and Service

- Small footprint
- Easy access service valves on all models
- Factory charged with R-410A refrigerant

Built to Last

- Low-ambient operation (down to 0°F/-17.8°C)
- Ball bearing fan motor

Warranty*

- Five-year compressor limited warranty (including compressor and coil)
 - With timely registration, an additional five-year parts limited warranty (including compressor and coil)

* For residential applications only.
See warranty certificate for complete details and restrictions, including warranty coverage for other applications.

Unit Performance Data

Model Number	Size (tons)	Nominal Btu/hr	Min. Circuit Ampacity	Max. Fuse or Breaker	Operating Dimensions H x W x D (sq) in (mm)	Ship/Operating Weight lbs (kg)
208/230-1-60						
NH4H418AKA	1-1/2	18,000	11.8	20	25-1/8 x 36-15/16 x 14-9/16 (638 x 938 x 370)	170/150 (77/68)
NH4H424AKA	2	24,000	16.5	25	31-1/8 x 36-15/16 x 14-9/16 (790 x 938 x 370)	181/161 (82/73)
NH4H430AKA	2-1/2	30,000	17.2	30	37-1/8 x 44-1/2 x 17-1/16 (943 x 1130 x 433)	226/196 (89/103)
NH4H436AKA	3	36,000	19.0	30	37-1/8 x 44-1/2 x 17-1/16 (943 x 1130 x 433)	197/227 (103/89)
NH4H448AKA	4	48,000	28.8	50	43-1/8 x 44-1/2 x 17-1/16 (1095 x 1130 x 433)	276/246 (125/112)
NH4H460AKA	5	60,000	33.4	50	43-1/8 x 44-1/2 x 17-1/16 (1095 x 1130 x 433)	288/258 (131/117)



R4H4

High-Efficiency 14.0 SEER Heat Pump Environmentally Balanced R-410A Refrigerant

1-1/2 – 5 Tons Split System
208 / 230 Volt, Single-Phase, 60 Hz

Refrigeration Circuit

- Scroll compressors on all models
- Suction line accumulator factory installed
- Integrated solid-state control with Time-Temperature Defrost
- High- and low-pressure switches
- Copper tube/aluminum fin coil

Easy-to-Install and Service

- Easy access service valves on all models
- External high- and low-refrigerant service ports
- Only two screws to access control panel
- Factory charged with R-410A refrigerant

Built to Last

- Painted cabinet finish over galvanized steel
- Coated inlet grille with 3/8" (10mm) spacing for extra protection

Warranty*

- Five-year compressor limited warranty
- Five-year compressor limited warranty (including compressor and coil)
 - With timely registration, an additional five-year parts limited warranty (including compressor and coil)

* For residential applications only.

See warranty certificate for complete details and restrictions, including warranty coverage for other applications.

Unit Performance Data

Model Number	Size (tons)	Nominal Btu/hr	Min. Circuit Ampacity	Max. Fuse or Breaker	Operating Dimensions H x W x D (sq) in (mm)	Ship/Operating Weight lbs (kg)
R4H418AKC	1-1/2	18,000	11.8	20	35-1/16 x 23-1/8 x 23-1/8 (891 x 587 x 587)	166/136 (75/61)
R4H418GKC	1-1/2	18,000	11.8	20	35-1/16 x 23-1/8 x 23-1/8 (891 x 587 x 587)	166/136 (75/61)
R4H424AKC	2	24,000	14.2	25	35-1/2 x 25-3/4 x 25-3/4 (901 x 654 x 654)	175/144 (79/65)
R4H424GKC	2	24,000	14.2	25	35-1/2 x 25-3/4 x 25-3/4 (901 x 654 x 654)	175/144 (79/65)
R4H430AKC	2-1/2	30,000	18.3	30	31-11/16 x 31-3/16 x 31-3/16 (804 x 792 x 792)	180/158 (82/72)
R4H430GKC	2-1/2	30,000	18.3	30	31-11/16 x 31-3/16 x 31-3/16 (804 x 792 x 792)	180/158 (82/72)
R4H436AKC	3	36,000	20.0	30	28-1/4 x 31-3/16 x 31-3/16 (630 x 792 x 792)	201/170 (91/77)
R4H436GKC	3	36,000	20.0	30	28-1/4 x 31-3/16 x 31-3/16 (630 x 792 x 792)	201/170 (91/77)
R4H442AKC	3-1/2	42,000	24.0	40	38-7/16 x 31-3/16 x 31-3/16 (977 x 792 x 792)	235/201 (107/91)
R4H442GKC	3-1/2	42,000	24.0	40	38-7/16 x 31-3/16 x 31-3/16 (977 x 792 x 792)	235/201 (107/91)
R4H448AKC	4	48,000	25.2	40	28-1/4 x 31-3/16 x 31-3/16 (718 x 792 x 792)	232/197 (105/89)
R4H448GKC	4	48,000	25.2	40	28-1/4 x 31-3/16 x 31-3/16 (718 x 792 x 792)	232/197 (105/89)
R4H460AKC	5	60,000	32.0	50	31-11/16 x 31-3/16 x 31-3/16 (804 x 792 x 792)	248/212 (113/96)
R4H460GKC	5	60,000	32.0	50	31-11/16 x 31-3/16 x 31-3/16 (804 x 792 x 792)	248/212 (113/96)

A = 2" (51 mm) spacing inlet grille G = 3/8" (10 mm) spacing inlet grille

Specifications subject to change without notice.

Accessories

Residential Heat Pumps

CSH6, CSH5, CSH4, N4H6, NXH6, NXH5, N4H4, R4H4			
Part Number	Description	Model	Used on Size
NASA00501CH	Crankhouse Heater for Scroll Compressor (208/230 V) (factory installed on some models)	CSH6	42, 48
		CSH5	36, 42
		CSH4	42, 60
		NXH5	42
NASA00601CH	Crankhouse Heater for Scroll Compressor (208/230 V) (factory installed on some models)	N4H4-C	24, 30, 36, 42
		CSH6	18, 24, 30
		CSH5	18, 24, 30
		CSH4	18, 24, 30
		NXH5	24
NASA001CH	Crankhouse Heater for Scroll Compressor (single-phase, 208/230 V)	N4H4-C	48, 60
		N4H4-G	42, 48, 60
		R4H4	42, 48, 60
		NXH6, NXH5	48, 60
NASA003CH	Crankhouse Heater for Scroll Compressor (single-phase, 208/230 V)	N4H4-C	18
		N4H4-G	18, 24, 30, 36
		R4H4	18, 24, 30, 36
		N4H6	24, 36
		NXH5	18, 30, 36
NASA003SC	Hard Start Kit (single-phase units only)	CSH6	36, 60
		N4H4-C	18
		N4H4-G	ALL
		R4H4	ALL
		N4H6	ALL
		NXH6	36, 60
		NXH5	18, 30, 36
NASA005SC	Hard Start Kit	N4H4-C	24, 30, 36, 42, 48, 60
		CSH4	42, 48, 60
NASA007SC	Hard Start Kit	CSH6, NXH6	18, 24, 30, 42, 48
NASA014SC	Hard Start Kit (Capacitor & Relay)	CSH4	18, 24, 30, 36
NASA001SJ	Sound Jacket, Compressor (factory installed on some models)	N4H4-C	18, 24, 30, 36, 42, 48
		CSH4	48
		N4H6	36, 48
		NXH5	ALL
		N4H4-G, R4H4	36, 42, 48
NASA002SJ	Sound Jacket, Compressor (factory installed on some models)	N4H6	24
		N4H4-G, R4H4	18, 24, 30
NASA003SJ	Sound Jacket, Compressor (factory installed on some models)	N4H4-C, N4H4-G R4H4, N4H6	60
		CSH4	42, 60
NASA00201SJ	Sound Jacket, Compressor	NXH6	18, 24, 30, 36
NASA00101SJ	Sound Jacket, Compressor	NXH6	42, 48, 60

Some accessories may be factory installed. Refer to product specifications for exact accessory match.

Accessories

Residential Heat Pumps

CSH6, CSH5, CSH4, N4H6, NXH6, NXH5, N4H4, R4H4 – Continued			
Part Number	Description	Model	Used on Size
TSTAT0201CW	Observer® Self-Configuring Communicating Wi-Fi® Wall Control	CSH6	ALL
		CSH5, CSH4	
NAEB40501TX	TXV Kit, R-410A - for use with aluminum piston coils	ALL	18, 24, 30
		N4H7	24
NAEB40601TX	TXV Kit, R-410A - for use with aluminum piston coils	ALL	36, 42
		CSH4, N4H7	36
NAEB40701TX	TXV Kit, R-410A - for use with aluminum piston coils	CSH4	42, 48, 60
		ALL	48, 60
NAEA40501TX	TXV Kit, R-410A - for use with copper or tin piston coils	ALL	18, 24, 30
NAEA40601TX		ALL	36, 42
NAEA40701TX		ALL	48, 60
NASA00201FS	Evaporator Freeze Thermostat		ALL
NASA001LS	Liquid Line Solenoid Valve, HP, R-22 or R-410A		ALL
NASA401LS	Liquid Line Solenoid Valve, HP, R-22 or R-410A		ALL CSH4
NASA001TD	Time Delay Relay, Indoor Blower		ALL
NASA001AC	Anti-Cycle Timer (5-minute delay)		ALL
NASA001SC	Start Component - PTC Device		ALL
NASA401LA	Low-Ambient Pressure Switch		ALL
NASA00101IK	Low-Ambient Isolation Relay Kit		ALL
NASA001SF	Support Feet, 4" (102 mm) tall (4 blocks)		31-1/4" and 35" Width Units
NASA00201SF	Support Feet, 4" (102 mm) tall (5 blocks)		23-1/8" and 25-3/4" Width Units
CCH624-60GKA1 (R-410A Two-Stage Communicating Heat Pump)			
Part Number	Description	Used on Model Size	
NASA001LS	Liquid Line Solenoid Valve, R-410A	ALL	
NASA001TD	Time Delay Relay, Indoor Blower	ALL	
NASA001SF	Support Feet, 4" (102 mm) tall (4 blocks)	31-1/4" and 35" Width Units	
NASA00201SF	Support Feet, 4" (102 mm) tall (5 blocks)	23-1/8" and 25-3/4" Width Units	
NASA010SC	Hard Start Kit	24	
NASA011SC	Hard Start Kit	36	
NASA012SC	Hard Start Kit	48	
NASA013SC	Hard Start Kit	60	
TSTAT0201CW	Observer® Self-Configuring Communicating Wi-Fi® Wall Control	ALL	
CCH624-60GKA2/3 (R-410A Two-Stage Communicating Heat Pump)			
NASA401LS	Liquid Line Solenoid Valve, R-410A	ALL	
NASA001TD	Time Delay Relay, Indoor Blower	ALL	
NASA001SF	Support Feet, 4" (102 mm) tall (4 blocks)	31-1/4" and 35" Width Units	
NASA00201SF	Support Feet, 4" (102 mm) tall (5 blocks)	23-1/8" and 25-3/4" Width Units	
NASA012SC	Hard Start Kit	24, 36	
NASA015SC	Hard Start Kit	48, 60	
TSTAT0201CW	Observer® Self-Configuring Communicating Wi-Fi® Wall Control	ALL	

Some accessories may be factory installed. Refer to product specifications for exact accessory match.

Accessories

Residential Heat Pumps

CVH8 (R-410A, Five-Stage Communicating Heat Pump)		
Part Number	Description	Used on Model Size
TSTAT0201CW	Observer® Self-Configuring Communicating Wi-Fi® Wall Control	ALL
NASA00201SF	Support Feet, 4" (102 mm) tall	24, 25, 36, 37, 48, 60
NASA00201FS*	Freeze Thermostat Kit	ALL
NAEA40501TX	TXV Kit, R-410A - for use with copper or tin piston coils	24, 25
NAEA40601TX		36, 37
NAEA40701TX		48, 60
NAEB40501TX	TXV Kit, R-410A - for use with aluminum piston coils	24, 25
NAEB40601TX		36, 37
NAEB40701TX		48, 60
1187979	Vapor Line Muffler	ALL

* Non-communicating

Residential Ducted Horizontal Heat Pumps – NH4H4

Kit Number	Description	Unit Size (Voltage/Series)											
		18	24	30	36	36	36	48	48	48	60	60	60
		AKA	AKA	AKA	AKA	AHA	ALA	AKA	AHA	ALA	AKA	AHA	ALA
NASA00601CH	Crankcase Heater	X	X	S	S	S	S						
NASA00501CH	Crankcase Heater							X	X		X	X	
NASA00301CH	Crankcase Heater									X			X
NASA001SC	PTC Start Assist	X	X	X	X			X			X		
NASA00201FS	Evaporator Freeze Stat	X	X	X	X	X	X	X	X	X	X	X	X
NASA001TD	Time Delay Relay	X	X	X	X	X	X	X	X	X	X	X	X
NASA00101IK	Isolation Relay	X	X	X	X	X	X	X	X	X	X	X	X
NASA401LA	Low-Ambient Kit	X	X	X	X	X	X	X	X	X	X	X	X
NASA00101WB	Wind Baffle	X											
NASA00201WB	Wind Baffle		X										
NASA00301WB	Wind Baffle			X	X	X	X						
NASA00401WB	Wind Baffle							X	X	X	X	X	X
NASA00101WM	Wall Mounting Kit	X	X										
NASA00201WM	Wall Mounting Kit			X	X	X	X	X	X	X	X	X	X
1177810	Sound Blanket Kit	X	X	X	X	X	X						
NASA001LS	Solenoid Valve Kit	X	X	X	X	X	X	X	X	X	X	X	X
NASA003SC	Capacitor Relay Start Assist	X	X	X	X			X			X		
NASA001AC	Cycle Protector	X	X	X	X	X	X	X	X	X	X	X	X

X = Accessory
S = Standard

90% Condensing Gas Furnaces



G9MAE

Up to 98% AFUE Communicating, Modulating Gas Furnace



Recommended
(Sold separately)



Easier to Sell

- Up to 98% AFUE in upflow and horizontal positions
- Up to 96.7% AFUE in downflow
- Modulating heating operation (40% - 100% capacity)
- Observer® Communicating Control System
- Xtra SEER variable-speed ECM blower motor
- Supports single- and two-stage cooling units
- Dehumidification feature in cooling
- California NOx approved
- Certified to leak 2% or less of nominal air conditioning CFM delivered when pressurized to 1-inch water column with all present air inlets, air outlets, and condensate drain port(s) sealed

Tougher

- Flame roll-out sensors standard
- Adjustable heating blower OFF delay
- Factory set blower ON delay
- RPJ® primary heat exchanger
- Stainless steel secondary heat exchanger
- High temperature limit control prevents overheating
- Direct ignition with Silicon Nitride ignitor

Quieter

- Operates at quieter, lower heating rates
- Variable-speed induced draft combustion blower
- Variable-speed ECM blower motor
- Insulated steel cabinet

Easy-to-Install and Service

- Direct vent (two-pipe) or ventilated combustion air
- 24 VAC humidifier terminal
- Electronic air cleaner terminal
- 35" (889 mm) high, for ease of installation and room for service
- Innovative knobs for easy door removal and secure attachment
- Factory shipped for natural gas with propane gas conversion kits available
- Four position – upflow/downflow/horizontal (left/right) installation
- At least 12 different venting configurations
- Through the casing flue pipe for counterflow or horizontal applications with accessory kit (order separately)
- Concentric vent available
- Simple troubleshooting of gas valve
- Self-configuring and communicating control
- Slide out heat exchanger assembly and blower assembly

Warranty*

- 10-year No Hassle Replacement™ limited warranty
- Lifetime heat exchanger limited warranty with timely registration
- Five-year parts limited warranty
 - With timely registration, an additional five-year parts limited warranty

* For residential applications only.
See warranty certificate for complete details and restrictions, including warranty coverage for other applications.



Qualifying models only.

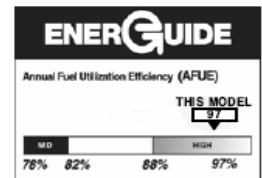

Unit Performance Data

Model Number	Heating Input (MBTUH)	Efficiency Range AFUE		Cooling Capacity CFM range @ .5 in wc (125 PA)	Operating Dimensions H x W x D (sq) in (mm)	Shipping Weight lbs (kg)
		Upflow/Hz	Downflow			
G9MAE0601714A	60,000	97.0%	95.0%	510-1335	35 x 17-1/2 x 29-1/2 (889 x 445 x 750)	154 (69)
G9MAE0602120A	60,600	98.0%	96.7%	510-1905	35 x 21 x 29-1/2 (889 x 533 x 750)	159 (70)
G9MAE0801714A	80,000	97.0%	95.0%	490-1375	35 x 17-1/2 x 29-1/2 (889 x 445 x 750)	164 (74)
G9MAE0802120A	80,000	97.0%	95.0%	750-1945	35 x 21 x 29-1/2 (889 x 533 x 750)	169 (77)
G9MAE1002122A	100,000	97.0%	95.0%	715-2160	35 x 21 x 29-1/2 (889 x 533 x 750)	179 (80)
G9MA1002422A	120,000	97.0%	95.0%	885-2185	35 x 24-1/2 x 29-1/2 (889 x 622 x 750)	203 (91)

G9MVE

Up to 96% AFUE, Communicating, Two-Stage Gas Furnace



Recommended
(Sold separately)

Easier to Sell

- Up to 96% AFUE, all models, all positions
- All models earn the ENERGY STAR®
- Series 'A2' approved for Twinning applications (0601714, 0801716, 1002120, and 1202422) with accessory (order separately)
- Series 'A4' (or greater) allow 15 Amp breaker (0802120, 1002120 and 1202422) with accessory (order separately)
- Two-stage heating operation
- Observer® Communicating Control System
- Xtra SEER variable-speed ECM blower motor
- Supports single- and two-stage cooling units
- Dehumidification feature in cooling
- California NOx approved
- Certified 2% or less leakage of nominal air conditioning CFM delivered when pressurized to 1-inch water column with all present air inlets, air outlets, and condensate drain port(s) sealed

Tougher

- Flame roll-out sensors standard
- Adjustable heating blower OFF delay
- Factory set blower ON delay
- RPJ® primary heat exchanger
- Stainless steel secondary heat exchanger
- High temperature limit control prevents overheating
- Direct ignition with Silicon Nitride ignitor

Quieter

- Operates at quieter, lower heating rates
- Two-speed induced draft combustion blower
- Variable-speed ECM blower motor
- Fully insulated steel cabinet

Easy-to-Install and Service

- Direct vent (two-pipe), single-pipe venting or ventilated combustion air
- 24 VAC humidifier terminal
- Electronic air cleaner terminal
- 35" (889 mm) high, for ease of installation
- Innovative knobs for easy door removal and secure attachment
- Factory shipped for natural gas with propane gas conversion kits available
- Four position – upflow/downflow/horizontal (left/right) installation
- At least twelve different venting configurations
- Through the casing flue pipe for counterflow or horizontal applications with accessory kit (order separately)
- Self-configuring and communicating control
- Concentric vent available
- Slide out heat exchanger assembly and blower assembly

Warranty*

- 10-year No Hassle Replacement™ limited warranty
- Lifetime heat exchanger limited warranty with timely registration
- Five-year parts limited warranty
 - With timely registration, an additional five-year parts limited warranty

* For residential applications only.

See warranty certificate for complete details and restrictions, including warranty coverage for other applications.

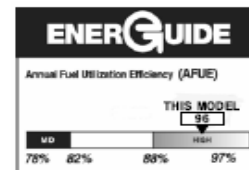

Unit Performance Data

Model Number	Heating Input (MBTUH)	Efficiency Range AFUE		Cooling Capacity CFM range @ .5 in wc (125 PA)	Operating Dimensions H x W x D (sq) in (mm)	Shipping Weight lbs (kg)
		Upflow/Hz	Downflow			
G9MVE0401410A	40,000	96.0%	95.0%	440-905	35 x 14-3/16 x 29-1/2 (889 x 361 x 750)	121 (54)
G9MVE0401712A	40,000	96.0%	95.0%	385-1065	35 x 17-1/2 x 29-1/2 (889 x 445 x 750)	131 (59)
G9MVE0601412A	60,000	95.0%	95.0%	420-1065	35 x 14-3/16 x 29-1/2 (889 x 361 x 750)	132 (60)
G9MVE0601714A	60,000	96.0%	95.0%	435-1475	35 x 17-1/2 x 29-1/2 (889 x 445 x 750)	142 (64)
G9MVE0801716A	80,000	96.0%	95.0%	555-1610	35 x 17-1/2 x 29-1/2 (889 x 445 x 750)	152 (68)
G9MVE0802120A	80,000	96.0%	95.0%	440-2005	35 x 21 x 29-1/2 (889 x 533 x 750)	156 (71)
G9MVE1002120A	100,000	96.0%	95.0%	405-2005	35 x 21 x 29-1/2 (889 x 533 x 750)	166 (75)
G9MVE1202422A	120,000	96.0%	95.0%	480-2115	35 x 24-1/2 x 29-1/2 (889 x 622 x 750)	190 (86)

G9MXT

Up to 96% AFUE Two-Stage, ECM Gas Furnace



Easier to Sell

- Up to 96% AFUE in upflow and horizontal positions
- 95.0% AFUE in downflow
- California NOx approved
- Xtra SEER ECM blower motor
- Supports single- and two-stage cooling units
- Approved for twinning applications (0601412 through 1202422) with accessory (order accessory)
- Dehumidification feature in cooling
- Electronic air cleaner terminal
- Certified to leak 2% or less of nominal air conditioning CFM delivered when pressurized to 1-inch water column with all present air inlets, air outlets, and condensate drain port(s) sealed

Tougher

- Flame roll-out sensors standard
- Adjustable heating blower OFF delay
- Factory set blower ON delay
- Stainless steel secondary heat exchanger
- High temperature limit control prevents overheating
- Direct ignition with Silicon Nitride ignitor
- High-quality, corrosion-resistant, one-piece steel cabinet

Quieter

- Operates at quieter, lower heating rates
- Two-speed induced draft combustion blower
- Insulated steel cabinet

Easy-to-Install and Service

- Direct vent (two-pipe), single-pipe venting or ventilated combustion air
- 24 VAC humidifier terminal
- 35" (889 mm) high, for ease of installation
- Innovative knobs for easy door removal and secure attachment
- Factory shipped for natural gas with propane gas conversion kits available
- Four position – upflow/downflow/horizontal (left/right) installation
- At least 12 different venting configurations
- Through the casing flue pipe for counterflow or horizontal applications with accessory kit (order separately)
- Concentric vent available
- Self diagnostics with super bright LED
- Slide out heat exchanger assembly and blower assembly

Warranty*

- Five-year No Hassle Replacement™ limited warranty
- Lifetime heat exchanger limited warranty with timely registration
- Five-year parts limited warranty
 - With timely registration, an additional five-year parts limited warranty

* For residential applications only. See warranty certificate for complete details and restrictions, including warranty coverage for other applications.

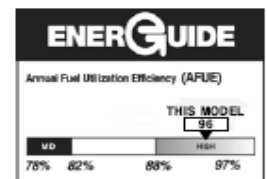

Unit Performance Data

Model Number	Heating Input (MBTUH)	Efficiency Range AFUE		Cooling Capacity CFM range @ .5 in wc (125 PA)	Operating Dimensions H x W x D (sq) in (mm)	Shipping Weight lbs (kg)
		Upflow/Hz	Downflow			
G9MXT0401410A	40,000	96.0%	95.0%	385-925	35 x 14-3/16 x 29-1/2 (889 x 361 x 750)	125 (56)
G9MXT0401712A	40,000	96.0%	95.0%	330-1085	35 x 17-1/2 x 29-1/2 (889 x 445 x 750)	135 (61)
G9MXT0601412A	60,000	96.0%	95.0%	620-1090	35 x 14-3/16 x 29-1/2 (889 x 361 x 750)	136 (62)
G9MXT0601714A	60,000	96.0%	95.0%	530-1505	35 x 17-1/2 x 29-1/2 (889 x 445 x 750)	146 (66)
G9MXT0801716A	80,000	96.0%	95.0%	920-1610	35 x 17-1/2 x 29-1/2 (889 x 445 x 750)	156 (70)
G9MXT0802120A	80,000	96.0%	95.0%	795-2015	35 x 21 x 29-1/2 (889 x 533 x 750)	161 (73)
G9MXT1002120A	100,000	96.0%	95.0%	1105-2110	35 x 21 x 29-1/2 (889 x 533 x 750)	171 (77)
G9MXT1202422A	120,000	96.0%	95.0%	1215-2055	35 x 24-1/2 x 29-1/2 (889 x 622 x 750)	195 (88)



G9MXE

Up to 96% AFUE, Single-Stage ECM Gas Furnace

Easier to Sell

- Up to 96% AFUE in upflow and horizontal positions
- 95% AFUE in downflow position
- Xtra SEER ECM blower motor
- Supports single- and two-stage cooling units
- Approved for twinning applications (0601714 through 1202422) with accessory (order separately)
- Approved for manufactured housing/mobile home applications with accessory (order separately)
- Dehumidification feature in cooling
- California NOx approved
- Certified 2% or less leakage of nominal air conditioning CFM delivered when pressurized to 1-inch water column with all present air inlets, air outlets, and condensate drain port(s) sealed

Warranty*

- One-year No Hassle Replacement™ limited warranty
- Lifetime heat exchanger limited warranty with timely registration
- Five-year parts limited warranty
 - With timely registration, an additional five-year parts limited warranty

* For residential applications only.

See warranty certificate for complete details and restrictions, including warranty coverage for other applications.

Tougher

- Flame roll-out sensors standard
- Adjustable heating blower OFF delay
- Factory set blower ON delay
- Stainless steel secondary heat exchanger
- High temperature limit control prevents overheating
- Direct ignition with Silicon Nitride ignitor
- High-quality, corrosion-resistant, one-piece steel cabinet

Quieter

- Insulated blower compartment

Easy-to-Install and Service

- Direct vent (two-pipe), single-pipe venting or ventilated combustion air
- 24 VAC humidifier terminal
- Electronic air cleaner terminal
- 35" (889 mm) high, for ease of installation
- Innovative knobs for easy door removal and secure attachment
- Factory shipped for natural gas with propane gas conversion kits available
- Four position – upflow/downflow/horizontal (left/right) installation
- At least 12 different venting configurations
- Through the casing flue pipe for counterflow or horizontal applications with accessory kit (order separately)
- Concentric vent available
- Self diagnostics with super bright LED
- Slide out heat exchanger assembly and blower assembly

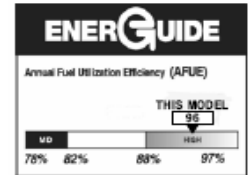

Unit Performance Data

Model Number	Heating Input (MBTUH)	Efficiency Range AFUE		Cooling Capacity CFM range @ .5 in wc (125 PA)	Operating Dimensions H x W x D (sq) in (mm)	Shipping Weight lbs (kg)
		Upflow/Hz	Downflow			
G9MXE0261410A	26,000	96.0%	95.0%	375-895	35 x 14-3/16 x 29-1/2 (889 x 361 x 750)	118 (54)
G9MXE0401410A	40,000	96.0%	95.0%	385-925	35 x 14-3/16 x 29-1/2 (889 x 361 x 750)	120 (54)
G9MXE0401712A	40,000	96.0%	95.0%	330-1085	35 x 17-1/2 x 29-1/2 (889 x 445 x 750)	135 (61)
G9MXE0601412A	60,000	95.5%	95.0%	620-1090	35 x 14-3/16 x 29-1/2 (889 x 361 x 750)	136 (62)
G9MXE0601714A	60,000	96.0%	95.0%	530-1505	35 x 17-1/2 x 29-1/2 (889 x 445 x 750)	141 (63)
G9MXE0801716A	80,000	96.0%	95.0%	920-1610	35 x 17-1/2 x 29-1/2 (889 x 445 x 750)	151 (98)
G9MXE0802120A	80,000	96.0%	95.0%	796-2015	35 x 21 x 29-1/2 (889 x 533 x 750)	156 (71)
G9MXE102120A	100,000	96.0%	95.0%	1105-2110	35 x 21 x 29-1/2 (889 x 533 x 750)	166 (75)
G9MXE120422A	120,000	96.0%	95.0%	1215-2055	35 x 24-1/2 x 29-1/2 (889 x 622 x 750)	190 (85)

N9MSE

Up to 95.5% AFUE Single-Stage Gas Furnace

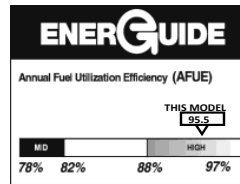

Easier to Sell

- Up to 95.5% AFUE in upflow and horizontal positions
- Up to 95.0% AFUE in downflow position
- California NOx approved
- Certified to leak 2% or less of nominal air conditioning CFM delivered when pressurized to 1-inch water column with all present air inlets, air outlets, and condensate drain port(s) sealed
- Approved for twinning applications (0601410 through 1202420) with accessory (order separately)
- Approved for manufactured housing/mobile home applications with accessory (order separately)

Tougher

- Flame roll-out sensors standard
- Adjustable heating blower OFF delay
- Factory set blower ON delay
- RPJ® primary heat exchanger
- Stainless steel secondary heat exchanger
- High temperature limit control prevents overheating
- Direct ignition with Silicon Nitride ignitor
- High-quality, corrosion-resistant, one-piece steel cabinet

Warranty*

- 20-year heat exchanger limited warranty
- Five-year parts limited warranty – With timely registration, an additional five-year parts limited warranty

* For residential applications only. See warranty certificate for complete details and restrictions, including warranty coverage for other applications.

Easy-to-Install and Service

- Direct vent (two-pipe), single-pipe venting or ventilated combustion air
- 24 VAC humidifier terminal and electronic air cleaner terminal
- 35" (889 mm) high, for ease of installation
- Simplified, factory installed internal condensate drain system
- Innovative knobs for easy door removal and secure attachment
- Factory shipped for natural gas with propane gas conversion kits available
- Four position – upflow/downflow/horizontal (left/right) installation
- At least 12 different venting configurations
- Through the casing flue pipe for counterflow or horizontal applications with accessory kit (order separately)
- Concentric vent available
- Self diagnostics with super bright LED
- Slide out heat exchanger assembly and blower assembly

Unit Performance Data

Model Number	Heating Input (MBTUH)	Efficiency Range AFUE		Cooling Capacity CFM range @ .5 in wc (125 PA)	Operating Dimensions H x W x D (sq) in (mm)	Shipping Weight lbs (kg)
		Upflow/Hz	Downflow			
N9MSE0261408A	26,000	95.5%	95.0%	440-775	35 x 14-3/16 x 29-1/2 (889 x 361 x 750)	120 (54)
N9MSE0401410A	40,000	95.5%	95.0%	625-905	35 x 14-3/16 x 29-1/2 (889 x 361 x 750)	123 (55)
N9MSE0401712A	40,000	95.5%	95.0%	620-1050	35 x 17-1/2 x 29-1/2 (889 x 445 x 750)	134 (61)
N9MSE0601410A	60,000	95.5%	95.0%	675-1130	35 x 14-3/16 x 29-1/2 (889 x 361 x 750)	127 (57)
N9MSE0601714A	60,000	95.5%	95.0%	650-1420	35 x 17-1/2 x 29-1/2 (889 x 445 x 750)	144 (65)
N9MSE0801716A	80,000	95.5%	95.0%	810-1600	35 x 17-1/2 x 29-1/2 (889 x 445 x 750)	154 (69)
N9MSE0802120A	80,000	95.5%	95.0%	1335-1970	35 x 21 x 29-1/2 (889 x 533 x 750)	162 (73)
N9MSE1002114A	100,000	95.5%	95.0%	915-1545	35 x 21 x 29-1/2 (889 x 533 x 750)	169 (76)
N9MSE1002120A	100,000	95.5%	95.0%	1345-2065	35 x 21 x 29-1/2 (889 x 533 x 750)	169 (76)
N9MSE1202420A	120,000	95.5%	95.0%	1320-2105	35 x 24-1/2 x 29-1/2 (889 x 622 x 750)	186 (84)
N9MSE1402420A	140,000	95.5%	94.4%	1290-2035	35 x 24-1/2 x 29-1/2 (889 x 622 x 750)	190 (86)



N9MSB

92.1% AFUE, Single-Stage Gas Furnace

Easier to Sell

- 92.1% AFUE, all models, all positions
- Approved for twinning applications (0601412 through 1202420) with accessory (order separately)
- Approved for manufactured housing/mobile home applications (0401410 through 1202420) with accessory (order separately)
- California NOx approved
- Certified 2% or less leakage of nominal air conditioning CFM delivered when pressurized to 1-inch water column with all present air inlets, air outlets, and condensate drain port(s) sealed

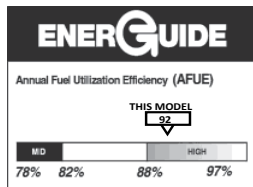

Tougher

- Flame roll-out sensors standard
- Adjustable heating blower OFF delay
- Factory set blower ON delay
- RPJ® primary heat exchanger
- Stainless steel secondary heat exchanger
- High temperature limit control prevents overheating
- Direct ignition with Silicon Nitride ignitor
- High-quality, corrosion-resistant, one-piece steel cabinet

Warranty*

- 20-year heat exchanger limited warranty
- Five-year parts limited warranty – With timely registration, an additional five-year parts limited warranty

* For residential applications only. See warranty certificate for complete details and restrictions, including warranty coverage for other applications.

Easy-to-Install and Service

- Direct vent (two-pipe), single-pipe venting or ventilated combustion air
- 24 VAC humidifier terminal
- Electronic air cleaner terminal
- 35" (889 mm) high, for ease of installation
- Simplified, factory installed internal condensate drain system
- Innovative knobs for easy door removal and secure attachment
- Factory shipped for natural gas with propane gas conversion kits available
- Four position – upflow/downflow/horizontal (left/right) installation
- At least 12 different venting configurations
- Through the casing flue pipe for counterflow or horizontal applications with accessory kit (order separately)
- Concentric vent available
- Self diagnostics with super bright LED
- Slide out heat exchanger assembly and blower assembly

Unit Performance Data

Model Number	Heating Input (MBTUH)	Efficiency Range AFUE		Cooling Capacity CFM range @ .5 in wc (125 PA)	Operating Dimensions H x W x D (sq) in (mm)	Shipping Weight lbs (kg)
		Upflow/Hz	Downflow			
N9MSB0401410C	40,000	92.1%	92.1%	595-970	35 x 14-3/16 x 29-1/2 (889 x 361 x 750)	121 (55)
N9MSB0401712C	40,000	92.1%	92.1%	655-1140	35 x 17-1/2 x 29-1/2 (889 x 445 x 750)	125 (57)
N9MSB0601412C	60,000	92.1%	92.1%	645-1155	35 x 14-3/16 x 29-1/2 (889 x 361 x 750)	127 (57)
N9MSB0601716C	60,000	92.1%	92.1%	985-1505	35 x 17-1/2 x 29-1/2 (889 x 445 x 750)	142 (65)
N9MSB0801716B	80,000	92.1%	92.1%	760-1555	35 x 17-1/2 x 29-1/2 (889 x 445 x 750)	151 (69)
N9MSB0802120C	80,000	92.1%	92.1%	865-1885	35 x 21 x 29-1/2 (889 x 533 x 750)	159 (72)
N9MSB1002116C	100,000	92.1%	92.1%	890-1490	35 x 21 x 29-1/2 (889 x 533 x 750)	166 (76)
N9MSB1002120C	100,000	92.1%	92.1%	1475-1970	35 x 21 x 29-1/2 (889 x 533 x 750)	166 (76)
N9MSB1202420C	120,000	92.1%	92.1%	1450-2050	35 x 24-1/2 x 29-1/2 (889 x 622 x 750)	184 (84)

R9MSB

92.1% AFUE Single-Stage Gas Furnace



Easier to Sell

- 92.1% AFUE, all models, all positions
- Approved for manufactured housing/mobile home applications with accessory (order separately)
- California NOx approved
- Certified 2% or less leakage of nominal air conditioning CFM delivered when pressurized to 1-inch water column with all present air inlets, air outlets, and condensate drain port(s) sealed

Tougher

- Flame roll-out sensors standard
- Adjustable heating blower OFF delay
- Factory set blower ON delay
- RPJ® primary heat exchanger
- Stainless steel secondary heat exchanger
- High temperature limit control prevents overheating
- Direct ignition with Silicon Nitride ignitor
- High-quality, corrosion-resistant, one-piece steel cabinet

Easy-to-Install and Service

- Direct vent (two-pipe), single-pipe venting or ventilated combustion air
- 24 VAC humidifier terminal and electronic air cleaner terminal
- 35" (889 mm) high, for ease of installation
- Simplified, factory installed internal condensate drain system
- Innovative knobs for easy door removal and secure attachment
- Factory shipped for natural gas with propane gas conversion kits available
- Four position – upflow/downflow/horizontal (left/right) installation
- At least 12 different venting configurations
- Through the casing flue pipe for counterflow or horizontal applications with accessory kit (order separately)
- Concentric vent available
- Self diagnostics with super bright LED
- Slide out heat exchanger assembly and blower assembly

Warranty*

- 20-year heat exchanger limited warranty
- Five-year parts limited warranty
 - With timely registration, an additional five-year parts limited warranty

* For residential applications only. See warranty certificate for complete details and restrictions, including warranty coverage for other applications.

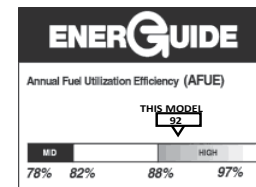

Unit Performance Data

Model Number	Heating Input (MBTUH)	Efficiency Range AFUE		Cooling Capacity CFM range @ .5 in wc (125 PA)	Operating Dimensions H x W x D (sq) in (mm)	Shipping Weight lbs (kg)
		Upflow/Hz	Downflow			
R9MSB0601716B	60,000	92.1%	92.1%	985-1505	35 x 17-1/2 x 29-1/2 (889 x 445 x 750)	142 (65)
R9MSB0801716A	80,000	92.1%	92.1%	760-1555	35 x 17-1/2 x 29-1/2 (889 x 445 x 750)	151 (69)
R9MSB1002120B	100,000	92.1%	92.1%	1475-1970	35 x 21 x 29-1/2 (889 x 533 x 750)	166 (76)
R9MSB1202420B	120,000	92.1%	92.1%	1450-2050	35 x 24-1/2 x 29-1/2 (889 x 622 x 750)	184 (84)

80% Gas Furnaces



G8MVL

80% AFUE Variable-Speed, Two-Stage Gas Furnace



Recommended
(Sold separately)



Easier to Sell

- 80% AFUE
- Series 'B' approved for Twinning applications (0902116, 1002122, and 1352422) with accessory (order separately)
- Supports two-stage cooling units
- Observer® Communicating Control System
- Flame roll-out sensors standard
- Category I venting
- Blocked vent switch
- Dehumidification feature in cooling
- 24 VAC humidifier terminal
- Electronic air cleaner terminal
- California NOx approved

Tougher

- Variable-speed ECM blower motor
- Adjustable heating blower OFF delay
- Factory set blower ON delay
- RPJ® aluminized steel heat exchanger
- High temperature limit control prevents overheating
- Direct ignition with Silicon Nitride ignitor
- One piece pre-painted steel cabinet

Quieter

- Two-stage operation
- Two-stage induced draft blower
- In-shot burners
- Insulated blower compartment

Easy-to-Install and Service

- 33-1/3" (847mm) high, for ease of installation
- Innovative knobs for easy door removal and secure attachment
- Factory shipped for natural gas with propane gas conversion kits available
- Four position – upflow/downflow/horizontal (left/right) installation
- Three position vent elbow capability
- Through the casing flue pipe for counterflow applications
- Common venting with other Category I appliances
- Masonry chimney adapter available
- Self diagnostics
- Slide out blower assembly

Warranty*

- 10-year No Hassle Replacement™ limited warranty
- 20-year heat exchanger limited warranty
- Five-year parts limited warranty
 - With timely registration, an additional five-year parts limited warranty

* For residential applications only.
See warranty certificate for complete details and restrictions, including warranty coverage for other applications.

Unit Performance Data

Model Number	Heating Input (MBTUH)	Upflow/Hz	Cooling Capacity CFM range @ .5 in wc (125 PA)	Operating Dimensions H x W x D (sq) in (mm)	Operating Weight lbs (kg)
G8MVL0451412B	44,000	80.0%	410-1175	33-1/3 x 14-3/16 x 29 (847 x 360 x 737)	107 (49)
G8MVL0701716B	66,000	80.0%	805-1685	33-1/3 x 17-1/2 x 29 (847 x 445 x 737)	126 (57)
G8MVL0902116B	88,000	80.0%	725-1770	33-1/3 x 21 x 29 (847 x 533 x 737)	146 (66)
G8MVL1102122B	110,000	80.0%	700-2230	33-1/3 x 21 x 29 (847 x 533 x 737)	152 (69)
G8MVL1352422B	132,000	80.0%	920-2290	33-1/3 x 24-1/2 x 29 (847 x 622 x 737)	163 (74)



G8MTL

80% AFUE Two-Stage Gas Furnace

Easier to Sell

- 80% AFUE
- Supports two-stage cooling units
- Flame roll-out sensors standard
- Category I venting
- Blocked vent switch
- Dehumidification feature in cooling
- 24 VAC humidifier terminal
- Electronic air cleaner terminal
- Twinning furnaces of same heating and cooling sizes
- California NOx approved
- Certified 2% or less leakage of nominal air conditioning CFM delivered when pressurized to 1-inch water gauge with all present air inlets, air outlets, and condensate drain port(s) sealed

Tougher

- PSC blower motor
- Adjustable heating blower OFF delay
- Factory set blower ON delay
- RPJ® aluminized steel heat exchanger
- High temperature limit control prevents overheating
- Direct ignition with Silicon Nitride ignitor
- One piece pre-painted steel cabinet

Quieter

- Two-stage operation
- Two-stage induced draft blower
- In-shot burners
- Blower compartment insulated

Easy-to-Install and Service

- 33-1/3" (847mm) high, for ease of installation
- Innovative knobs for easy door removal and secure attachment
- Factory shipped for natural gas with propane gas conversion kits available
- Four position – upflow/downflow/horizontal (left/right) installation
- Three position vent elbow capability
- Through the casing flue pipe for counterflow applications
- Common venting with other Category I appliances
- Masonry chimney adapter available
- Self diagnostics
- Slide out blower assembly

Warranty*

- Five-year No Hassle Replacement™ limited warranty
- 20-year heat exchanger limited warranty
- Five-year parts limited warranty
 - With timely registration, an additional five-year parts limited warranty

* For residential applications only.
See warranty certificate for complete details and restrictions, including warranty coverage for other applications.

Unit Performance Data

Model Number	Heating Input (MBTUH)	Upflow/Hz	Cooling Capacity CFM range @ .5 in wc (125 PA)	Operating Dimensions H x W x D (sq) in (mm)	Operating Weight lbs (kg)
G8MTL0451412A	44,000	80.0%	745-1175	33-1/3 x 14-3/16 x 29 (847 x 360 x 737)	107 (49)
G8MTL0701412A	66,000	80.0%	670-1240	33-1/3 x 14-3/16 x 29 (847 x 360 x 737)	115 (52)
G8MTL0901714A	88,000	80.0%	1065-1385	33-1/3 x 17-1/2 x 29 (847 x 445 x 737)	127 (58)
G8MTL1102122A	110,000	80.0%	1180-2235	33-1/3 x 21 x 29 (847 x 533 x 737)	152 (69)

N8MXL

80% AFUE Single-Stage Gas Furnace



Easier to Sell

- 80% AFUE
- Flame roll-out sensors standard
- Category I venting
- Blocked vent switch
- Louvered door
- 24 VAC humidifier terminal
- Electronic air cleaner terminal
- California NOx approved
- Cabinet air leakage less than 2.0% at 1.0 in. water column and cabinet air leakage less than 1.4% at 0.5 in. water column when tested in accordance with ASHRAE standard 193

Tougher

- ECM blower motor
- Adjustable heating blower OFF delay
- Factory set blower ON delay
- RPJ® aluminized steel heat exchanger
- High temperature limit control prevents overheating
- Direct ignition with Silicon Nitride ignitor
- One piece pre-painted steel cabinet

Quieter

- In-shot burners

Easy-to-Install and Service

- 33-1/3" (847mm) high, for ease of installation
- Innovative knobs for easy door removal and secure attachment
- Factory shipped for natural gas with propane gas conversion kits available
- Four position – upflow/downflow/horizontal (left/right) installation
- Three position vent elbow capability
- Through the casing flue pipe for counterflow applications
- Common venting with other Category I appliances
- Masonry chimney adapter available
- Self diagnostics
- Slide out blower assembly

Warranty*

- 20-year heat exchanger limited warranty
- 10-year parts limited warranty with timely registration
- Five-year parts limited warranty if not registered within 90 days of original installation

* For residential applications only.
See warranty certificate for complete details and restrictions, including warranty coverage for other applications.

Unit Performance Data

Model Number	Heating Input (MBTUH)	Efficiency AFUE	Cooling Capacity CFM range @ .5 in wc (125 PA)	Operating Dimensions H x W x D (sq) in (mm)	Operating Weight lbs (kg)
N8MXL0451412A	44,000	80.0%	415-1080	33-1/3 x 14-3/16 x 29 (847 x 360 x 737)	104 (47)
N8MXL0701712A	66,000	80.0%	385-1005	33-1/3 x 17-1/2 x 29 (847 x 445 x 737)	126 (57)
N8MXL0701716A	66,000	80.0%	875-1435	33-1/3 x 17-1/2 x 29 (847 x 445 x 737)	126 (57)
N8MXL0901714A	88,000	80.0%	750-1210	33-1/3 x 17-1/2 x 29 (847 x 445 x 737)	127 (58)
N8MXL0902116A	88,000	80.0%	845-1445	33-1/3 x 21 x 29 (847 x 533 x 737)	140 (64)
N8MXL0902120A	88,000	80.0%	915-1980	33-1/3 x 21 x 29 (847 x 533 x 737)	140 (64)
N8MXL1102120A	110,000	80.0%	990-2040	33-1/3 x 21 x 29 (847 x 533 x 737)	152 (69)
N8MXL1352420A	132,000	80.0%	1025-1810	33-1/3 x 24-1/2 x 29 (847 x 622 x 737)	163 (74)



N8MSN, N8MSL

80% AFUE Single-Stage Gas Furnace

Easier to Sell

- 80% AFUE
- Flame roll-out sensors standard
- Category I venting
- Blocked vent switch
- 24 VAC humidifier terminal
- Electronic air cleaner terminal
- Twinning furnaces of same heating and cooling sizes
- California NOx approved
- Certified 2% or less leakage of nominal air conditioning CFM delivered when pressurized to 1-inch water gauge with all present air inlets, air outlets, and condensate drain port(s) sealed

Warranty*

- 20-year heat exchanger limited warranty with timely registration
- Five-year parts limited warranty
 - With timely registration, an additional five-year parts limited warranty

* For residential applications only.

See warranty certificate for complete details and restrictions, including warranty coverage for other applications.

Tougher

- PSC blower motor
- Adjustable heating blower OFF delay
- Factory set blower ON delay
- RPJ® aluminized steel heat exchanger
- High temperature limit control prevents overheating
- Direct ignition with Silicon Nitride ignitor
- One piece pre-painted steel cabinet

Quieter

- In-shot burners

Easy-to-Install and Service

- 33-1/3" (847mm) high, for ease of installation
- Innovative knobs for easy door removal and secure attachment
- Factory shipped for natural gas with propane gas conversion kits available
- Four position – upflow/downflow/horizontal (left/right) installation
- Three position inducer elbow capability
- Through the casing flue pipe for counterflow applications
- Common venting with other Category I appliances
- Masonry chimney adapter available
- Self diagnostics
- Slide out blower assembly

Unit Performance Data

Model Number	Heating Input (MBTUH)	Efficiency AFUE	Cooling Capacity CFM range @ .5 in wc (125 PA)	Operating Dimensions H x W x D (sq) in (mm)	Operating Weight lbs (kg)
N8MSN0451408A	44,000	80.0%	580-835	33-1/3 x 14-3/16 x 29 (847 x 360 x 737)	107 (49)
N8MSN0451412A	44,000	80.0%	1040-1160	33-1/3 x 14-3/16 x 29 (847 x 360 x 737)	107 (49)
N8MSN0701408A	66,000	80.0%	595-870	33-1/3 x 14-3/16 x 29 (847 x 360 x 737)	111 (50)
N8MSN0701412A	66,000	80.0%	1050-1200	33-1/3 x 14-3/16 x 29 (847 x 360 x 737)	115 (52)
N8MSN0701716A	66,000	80.0%	1240-1505	33-1/3 x 17-1/2 x 29 (847 x 445 x 737)	126 (57)
N8MSN0901714B	88,000	80.0%	1065-1385	33-1/3 x 17-1/2 x 29 (847 x 445 x 737)	127 (58)
N8MSN0902116A	88,000	80.0%	1375-1635	33-1/3 x 21 x 29 (847 x 533 x 737)	140 (64)
N8MSN0902120A	88,000	80.0%	1715-2025	33-1/3 x 21 x 29 (847 x 533 x 737)	146 (66)
N8MSN1101712A	110,000	80.0%	1155-1355	33-1/3 x 17-1/2 x 29 (847 x 445 x 737)	135 (61)
N8MSN1102116A	110,000	80.0%	1310-1655	33-1/3 x 21 x 29 (847 x 533 x 737)	146 (66)
N8MSN1102122A	110,000	80.0%	1650-2205	33-1/3 x 21 x 29 (847 x 533 x 737)	152 (69)
N8MSN1352116A	132,000	80.0%	1380-1710	33-1/3 x 21 x 29 (847 x 533 x 737)	149 (68)
N8MSN1352422A	132,000	80.0%	1705-2160	33-1/3 x 24-1/2 x 29 (847 x 622 x 737)	163 (74)
N8MSN1552420A	154,000	80.0%	1695-2215	33-1/3 x 24-1/2 x 29 (847 x 622 x 737)	170 (77)

N8MSN, N8MSL con't

80% AFUE Single-Stage Gas Furnace

Unit Performance Data

Model Number	Heating Input (MBTUH)	Efficiency AFUE	Cooling Capacity CFM range @ .5 in wc (125 PA)	Operating Dimensions H x W x D (sq) in (mm)	Operating Weight lbs (kg)
Low NOx Models					
N8MSL0451408A	44,000	80.0%	580-835	33-1/3 x 14-3/16 x 29 (847 x 360 x 737)	107 (49)
N8MSL0451412A	44,000	80.0%	1040-1160	33-1/3 x 14-3/16 x 29 (847 x 360 x 737)	107 (49)
N8MSL0701408A	66,000	80.0%	595-870	33-1/3 x 14-3/16 x 29 (847 x 360 x 737)	111 (50)
N8MSL0701412A	66,000	80.0%	1050-1200	33-1/3 x 14-3/16 x 29 (847 x 360 x 737)	115 (52)
N8MSL0701716A	66,000	80.0%	1240-1505	33-1/3 x 17-1/2 x 29 (847 x 445 x 737)	126 (57)
N8MSL0901714B	88,000	80.0%	1065-1385	33-1/3 x 17-1/2 x 29 (847 x 445 x 737)	127 (58)
N8MSL0902116A	88,000	80.0%	1375-1635	33-1/3 x 21 x 29 (847 x 533 x 737)	140 (64)
N8MSL0902120A	88,000	80.0%	1715-2025	33-1/3 x 21 x 29 (847 x 533 x 737)	146 (66)
N8MSL1101712A	110,000	80.0%	1155-1355	33-1/3 x 17-1/2 x 29 (847 x 445 x 737)	135 (61)
N8MSL1102116A	110,000	80.0%	1310-1655	33-1/3 x 21 x 29 (847 x 533 x 737)	146 (66)
N8MSL1102122A	110,000	80.0%	1650-2205	33-1/3 x 21 x 29 (847 x 533 x 737)	152 (69)
N8MSL1352116A	132,000	80.0%	1380-1710	33-1/3 x 21 x 29 (847 x 533 x 737)	149 (68)
N8MSL1352422A	132,000	80.0%	1705-2160	33-1/3 x 24-1/2 x 29 (847 x 622 x 737)	163 (74)
N8MSL1552420A	154,000	80.0%	1695-2215	33-1/3 x 24-1/2 x 29 (847 x 622 x 737)	170 (77)



R8MXL

80% AFUE Single-Stage Gas Furnace

Easier to Sell

- 80% AFUE
- Flame roll-out sensors standard
- Category I venting
- Blocked vent switch
- Louvered door
- 24 VAC humidifier terminal
- Electronic air cleaner terminal
- California NOx approved
- Cabinet air leakage less than 2.0% at 1.0 in. water column and cabinet air leakage less than 1.4% at 0.5 in. water column when tested in accordance with ASHRAE standard 193

Tougher

- ECM blower motor
- Adjustable heating blower OFF delay
- Factory set blower ON delay
- RPJ® aluminized steel heat exchanger
- High temperature limit control prevents overheating
- Direct ignition with Silicon Nitride ignitor
- One piece pre-painted steel cabinet

Quieter

- In-shot burners

Easy-to-Install and Service

- 33-1/3" (847mm) high, for ease of installation
- Innovative knobs for easy door removal and secure attachment
- Factory shipped for natural gas with propane gas conversion kits available
- Four position – upflow/downflow/horizontal (left/right) installation
- Three position vent elbow capability
- Through the casing flue pipe for counterflow applications
- Common venting with other Category I appliances
- Masonry chimney adapter available
- Self diagnostics
- Slide out blower assembly

Warranty*

- 20-year heat exchanger limited warranty
- 10-year parts limited warranty with timely registration
- Five-year parts limited warranty if not registered within 90 days of original installation

* For residential applications only.

See warranty certificate for complete details and restrictions, including warranty coverage for other applications.

Unit Performance Data

Model Number	Heating Input (MBTUH)	Efficiency AFUE	Cooling Capacity CFM range @ .5 in wc (125 PA)	Operating Dimensions H x W x D (sq) in (mm)	Operating Weight lbs (kg)
R8MXL0451412A	44,000	80.0%	415-1080	33-1/3 x 14-3/16 x 29 (847 x 360 x 737)	104 (47)
R8MXL0701712A	66,000	80.0%	385-1005	33-1/3 x 17-1/2 x 29 (847 x 445 x 737)	126 (57)
R8MXL0701716A	66,000	80.0%	875-1435	33-1/3 x 17-1/2 x 29 (847 x 445 x 737)	126 (57)
R8MXL0901714A	88,000	80.0%	750-1210	33-1/3 x 17-1/2 x 29 (847 x 445 x 737)	127 (58)
R8MXL0902116A	88,000	80.0%	845-1445	33-1/3 x 21 x 29 (847 x 553 x 737)	140 (64)
R8MXL0902120A	88,000	80.0%	915-1980	33-1/3 x 21 x 29 (847 x 553 x 737)	140 (64)
R8MXL1102120A	110,000	80.0%	990-2040	33-1/3 x 21 x 29 (847 x 553 x 737)	152 (69)
R8MXL1352420A	132,000	80.0%	1025-1810	33-1/3 x 24-1/2 x 29 (847 x 622 x 737)	163 (74)

R8MSN, R8MSL

80% AFUE Single-Stage Gas Furnace



Easier to Sell

- 80% AFUE
- Flame roll-out sensors standard
- Category I venting
- Blocked vent switch
- 24 VAC humidifier terminal
- Electronic air cleaner terminal
- Twinning furnaces of same heating and cooling sizes
- California NOx approved
- Certified 2% or less leakage of nominal air conditioning CFM delivered when pressurized to 1-inch water gauge with all present air inlets, air outlets, and condensate drain port(s) sealed

Tougher

- PSC blower motor
- Adjustable heating blower OFF delay
- Factory set blower ON delay
- RPJ® aluminized steel heat exchanger
- High temperature limit control prevents overheating
- Direct ignition with Silicon Nitride ignitor
- One piece prepainted steel cabinet

Quieter

- In-shot burners

Easy-to-Install and Service

- 33-1/3" (847mm) high, for ease of installation
- Innovative knobs for easy door removal and secure attachment
- Factory shipped for natural gas with propane gas conversion kits available
- Four position – upflow/downflow/horizontal (left/right) installation
- Three position inducer elbow capability
- Through the casing flue pipe for counterflow applications
- Common venting with other Category I appliances
- Masonry chimney adapter available
- Self diagnostics
- Slide out blower assembly

Warranty*

- 20-year heat exchanger limited warranty with timely registration
- Five-year parts limited warranty
 - With timely registration, an additional five-year parts limited warranty

* For residential applications only.

See warranty certificate for complete details and restrictions, including warranty coverage for other applications.

Unit Performance Data

Model Number	Heating Input (MBTUH)	Efficiency AFUE	Cooling Capacity CFM range @ .5 in wc (125 PA)	Operating Dimensions H x W x D (sq) in (mm)	Operating Weight lbs (kg)
R8MSN0451412A	44,000	80.0%	1040-1160	33-1/3 x 14-3/16 x 29 (847 x 360 x 737)	107 (49)
R8MSN0701412A	66,000	80.0%	1050-1200	33-1/3 x 14-3/16 x 29 (847 x 360 x 737)	115 (52)
R8MSN0902120A	88,000	80.0%	1715-2025	33-1/3 x 21 x 29 (847 x 533 x 737)	146 (66)
R8MSN1102122A	110,000	80.0%	1650-2205	33-1/3 x 21 x 29 (847 x 533 x 737)	152 (69)
Low NOx					
R8MSL0451412A	44,000	80.0%	1040-1160	33-1/3 x 14-3/16 x 29 (847 x 360 x 737)	107 (49)
R8MSL0701412A	66,000	80.0%	1050-1200	33-1/3 x 14-3/16 x 29 (847 x 360 x 737)	115 (52)
R8MSL0902120A	88,000	80.0%	1715-2025	33-1/3 x 21 x 29 (847 x 533 x 737)	146 (66)
R8MSL1102122A	110,000	80.0%	1650-2205	33-1/3 x 21 x 29 (847 x 533 x 737)	152 (69)

Accessories

Gas Furnaces

Model Number	Description	Used with Models
Twinning Kit		
NAHA00601WK	Allows operation of two identical size model furnaces.	All G8MT and N8MS Models
NAHA00701WK	Allows operation of two identical size model furnaces.	G9MXT, G9MXE, N9MSB, N9MSE 060/080/100/120k Models
NAHA00801WK	Allows operation of two identical size model furnaces.	G9MVE (A2 Series), G8MVL (B Series) 060/080/90/100/110/120/135k Models
Gas Conversion Kits		
Natural Gas to Propane Gas		
NAHD00901LP	Natural gas to propane conversion kit. Allows field conversion to propane gas.	All N8MX, N8MS, G9MXE, N9MSE, N9MSB Models
NAHB01001LP	Natural gas to propane conversion kit. Allows field conversion to propane gas.	All G8MVL, G8MTL, G9MAE, G9MVE, G9MXT Models
NAHA01201LP	Natural gas to propane conversion kit. Allows field conversion to propane gas.	All 26K G9MXE, N9MSE Models
Mobile Home Conversion Kit		
NAHB0101MH	Single-stage conversion kit	G9MXE, N9MS 40,000 to 120,000 Models
Propane Gas to Natural Gas		
NAHD00901NG	Propane to natural gas conversion kit. Allows field conversion to natural gas.	All N8MX, N8MS, G9MXE, N9MSE, N9MSB Models
NAHB01001NG	Propane to natural gas conversion kit. Allows field conversion to natural gas.	All G8MVL, G8MTL, G9MAE, G9MVE, G9MXT Models
NAHA01201NG	Natural gas to propane conversion kit. Allows field conversion to natural gas.	All 26K G9MXE, N9MSE Models
Neutralizer Kit		
NAHA001NK 612833+	Condensate neutralizer kit for condensing gas furnaces.	All 90+ furnaces if required
Coil Adapter		
NAHB00101CA	Coil Adapter Kit with no offset	All G9MAE, G9MVE, G9MXT, G9MXE, N9MSB, N9MSE
NAHB00201CA	Coil Adapter Kit with single offset	All G9MAE, G9MVE, G9MXT, G9MXE, N9MSB, N9MSE
NAHB00301CA	Coil Adapter Kit with double offset	All G9MAE, G9MVE, G9MXT, G9MXE, N9MSB, N9MSE
Return Air Base (Upflow Applications)		
NAHA01401RA	Return Air Kit 14.2" Wide	All G9MAE, G9MVE, G9MXT, G9MXE, N9MSB, N9MSE
NAHA01701RA	Return Air Kit 17.5" Wide	All G9MAE, G9MVE, G9MXT, G9MXE, N9MSB, N9MSE
NAHA02101RA	Return Air Kit 21" Wide	All G9MAE, G9MVE, G9MXT, G9MXE, N9MSB, N9MSE
NAHA02401RA	Return Air Kit 24.5" Wide	All G9MAE, G9MVE, G9MXT, G9MXE, N9MSB, N9MSE

+ Must be ordered from Service Parts

(A)=Series A, (B)=Series B, (C)=Series D and (D)=Series D

Accessories

Gas Furnaces

Model Number	Description	Used with Models
Filter Kits		
NAHB00501FF*	Bottom return filter rack 14"	All 14" G8M, N8MX, N8MS, G9M, N9MS
NAHB00601FF*	Bottom return filter rack 17"	All 17" G8M, N8MX, N8MS, G9M, N9MS
NAHA00506FB†	Washable filter, 1-inch 16 x 25" (6 pack)	All 17" and 14" G8M, N8MX, N8MS, G9M, N9MS
NAHB00701FF*	Bottom return filter rack 21"	All 21" G8M, N8MX, N8MS, G9M, N9MS
NAHB00801FF*	Bottom return filter rack 24"	All 24" G8M, N8MX, N8MS, G9M, N9MS
NAHA00706FB	Washable filter, 1-inch 24 x 25" (6 pack)	All 21" and 24" G8M, N8MX, N8MS, G9M, N9MS
NAHB00501FF	External side return filter rack 16 x 25"	All G8M, N8MX, N8MS, G9M, N9MS

* Washable filter included with rack † Suitable for side return filter rack and 17" external bottom filter rack

Model Number	Description	Used with Models
Combustible Floor Subbases		
NAHA01101SB	Combustible Floor Subbase (not required when evaporator coil case is use)	Counterflow G8M, N8MX, N8MS, G9M, N9MS
High Altitude Kit and Pressure Switch		
NAHA00201HL	High Altitude Kit	G8MVL and G8MTL
Warning Label Replacement Kit		
NAHB00301WL	To replace warning and operating labels	All G8M, N8MX, N8MS furnace
Vent Kits		
NAHB00301VC	Downflow vent guard (not required when vent is routed through cabinet)	All G8M, N8MX, N8MS furnaces in the downflow applications
NAHA00101VC	Internal Vent Kit (through the cabinet)	All G9M, N9MS furnaces
NAHA00301VT	2" Direct Vent Termination Bracket	All G9M, N9MS furnaces
NAHA00401VT	3" Direct Vent Termination Bracket	All G9M, N9MS furnaces
NAHA00401CV 1011129+	3" (76.2 mm) Concentric Vent Kit allows single wall penetration for two pipe direct vent applications (90+)	G9M, N9MS (see vent tables)
NAHA002CV	2" (50.8 mm) Concentric Vent Kit allows single wall penetration for two pipe direct vent applications (90+)	G9M, N9MS (see vent tables)
1188419 (Fast No.)	Inlet Air Pipe Coupling for polypropylene vent systems	All G9M, N9MS furnaces
Masonry Chimney Adapter		
NAHA00301DH	Chimney Adapter Kit 5"	G8M, N8MX, N8MS Greater than or equal to 135,000 Btuh
NAHA00401DH	Chimney Adapter Kit 4"	G8M, N8MX, N8MS - Less than 135,000 Btuh
Freeze Protection		
NAHA00101HH	Condensate drain line protection	All G9M, N9MS furnaces
NAHA00201HH	Condensate freeze protection	All G9M, N9MS furnaces
Horizontal Installation Kit		
NAHA00101HV	Trap Grommet (direct vent application only)	All G9M, N9MS furnaces
Drain Accessory Kit		
NAHA00110DA	1/2" CPVC to 3/4" PVC (10 pack)	All G9M, N9MS furnaces
NAHA00101CT	External Drain Kit	All G9M, N9MS furnaces
Motor Simulator Kit		
NAHA00101MS	Motor Simulation Kit	All G9MAE furnaces
Lower Amp Kit		
NAHA00101PC	Lower Amp/Power Choke Kit for 5T and 5.5T ECM-PWM	G9MVE 802120A4, 1002120A4, 1202422A4

+ Must be ordered from Service Parts

Oil Furnaces



OUF

Hi-Boy Upflow Oil Furnace



Available in Canada Only

Features

- Fan control switch for continuous low speed
- Accessory terminals pre-wired for easy add-on electronic air cleaner and power humidifier
- Air conditioning ready for easy add-on
- Large external front clean out for easy cleaning
- Clean out sealed from blower compartment (no soot to spread)
- Easy access control panel
- Sight glass/view port
- Furnaces available with your choice of high-efficiency Riello or Beckett burners (Burners ordered and shipped separately)
- Test ports factory installed to provide efficient access for set-up and service
- Easy access heat exchanger manufactured from heavy gauge steel
- Multi-speed direct drive motors permanently lubricated for long life performance
- Heavy-duty insulated cabinet for quiet operation
- Approved for 1" (25mm) clearance to combustibles for tight installations
- Ceramic combustion chamber withstands temperature of 2600° F (1427° C) with unique self aligning design
- Precision balanced blower ensures quiet, efficient air distribution
- Raised cabinet base allows air to circulate under the cabinet, eliminates dampness
- Approved chimney or direct vent applications
- Efficient AFUE up to 86.1% Canada, 84.8% US
- Front flue (breach)

Warranty*

- Lifetime heat exchanger limited warranty with timely registration
- Five-year parts limited warranty
 - With timely registration, an additional five-year parts limited warranty

* Applies to original purchaser/homeowner, some limitations may apply. See warranty certificate for complete details.

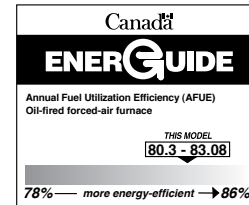

ONLY applies to applications in Canada where the furnace is installed in the conditioned space, per sections 5.35.1.2 and 4.7.1.1 of CSA standard B212 dated October 2000.

Unit Performance Data

Model Number	Input (MBTUH)	Efficiency AFUE		Cooling Capacity @ .5 in wc (125 Pa)	Dimensions H x W x D* (sq) in (mm)	Operating Weight lbs (kg)
		Canada	US			
OUF105A12C	70,000 - 105,000	80.9 - 86.1	79.4 - 84.8	2 - 3 ton	48 x 21 x 23.4 (1219 x 533 x 594)	200 (91)
OUF160B18C	119,000 - 159,600	81.3 - 85.4	80.0 - 84.3	3.5 - 5 ton	58-1/4 x 25 x 27.4 (1480 x 635 x 696)	248 (112)

*Depth without the burner.

OLF, OLR

Lo-Boy Upflow Oil Furnace

Available in Canada Only



Features

- Fan control switch for continuous fan operation
- Accessory terminals pre-wired for easy add-on electronic air cleaner and power humidifier
- Air conditioning ready for easy add-on
- Large external front clean out for easy cleaning
- Clean out sealed from blower compartment (no soot to spread)
- Easy access control panel
- Sight glass/view port (some models only)
- Furnaces available with your choice of high-efficiency Riello or Beckett burners (Burners ordered and shipped separately)
- Easy access heat exchanger manufactured from heavy gauge steel
- Multi-speed direct drive motors permanently lubricated for long life performance
- Heavy-duty insulated cabinet for quiet operation
- Approved for 1" (25mm) clearance to combustibles for tight installations
- Ceramic combustion chamber withstands temperature of 2600° F (1427° C) with unique self aligning design
- Precision balanced blower ensures quiet, efficient air distribution
- Raised cabinet base allows air to circulate under the cabinet, eliminates dampness
- Approved chimney or some direct vent applications with accessories
- Efficient AFUE up to 85.7% Canada, 85.1% US
- OLF - Front flue (breach)
- OLR - Rear flue (breach)

Warranty*

- Lifetime heat exchanger limited warranty with timely registration
- Five-year parts limited warranty
 - With timely registration, an additional five-year parts limited warranty

* For residential applications only. See warranty certificate for complete details and restrictions, including warranty coverage for other applications.

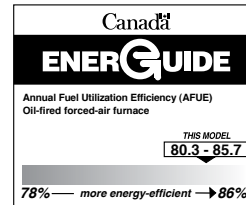

ONLY applies to applications in Canada where the furnace is installed in the conditioned space, per sections 5.35.1.2 and 4.7.1.1 of CSA standard B212 dated October 2000.

Unit Performance Data

Model Number	Input (MBTUH)	Efficiency AFUE		Cooling Capacity @ .5 in wc (125 Pa)	Dimensions H x W x D* (sq) in (mm)	Operating Weight lbs (kg)
		Canada	US			
OLR105A12D	70,000 - 105,000	83.7 - 86.8	80.5 - 85.7	1.5 - 3 ton	32 x 21 x 43.4 (813 x 533 x 1102)	200 (91)
OLF105A12C	70,000 - 105,000	81.9 - 85.9	78.7 - 86.0	1.5 - 3 ton	32 x 21 x 43.4 (813 x 533 x 1102)	207 (94)
OLR160B20C	119,000 - 159,600	80.4 - 85.1	78.7 - 83.1	1.5 - 5 ton	40 x 25 x 51.4 (1016 x 635 x 1306)	235 (107)

*Depth without the burner.

OMF

Hi-Boy Multi-Position Oil Furnace

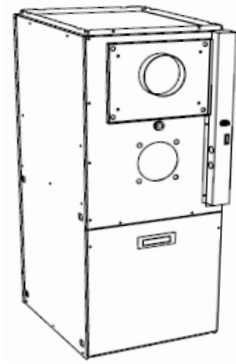

Features

- Stainless steel, heavy gauge heat exchanger quickly transfers heat to the ambient air
- Multi-position, four-way multi-poise unit that opens up installation possibilities
- Low profile – OMF098 is 40-3/4" (1035mm) high, OMF112 is 41-1/2" (1054 mm) high, OMF 154 is 47-7/8" (1216 mm) high
- Sound attenuator, integrated inside secondary heat exchanger
- High density acoustic wool dampens combustion sound
- Choice of high static pressure oil burners: Beckett AFG and NX, Riello 40 (burners must be ordered separately)
- Inspection port external for easy access and sealed, adjust combustion parameters and simplify inspections
- Approved for chimney vent and sealed combustion installations
- High quality, high-gloss baked finish
- Efficient AFUE up to 87.0% Canada, 86.4% US
- Front flue (breach)

Warranty*

- Lifetime heat exchanger limited warranty with timely registration
- Five-year parts limited warranty
 - With timely registration, an additional five-year parts limited warranty

* For residential applications only. See warranty certificate for complete details and restrictions, including warranty coverage for other applications.

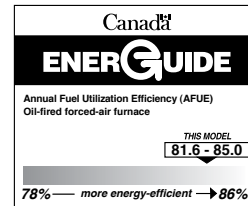

ONLY applies to applications in Canada where the furnace is installed in the conditioned space, per sections 5.35.1.2 and 4.7.1.1 of CSA standard B212 dated October 2000.

Unit Performance Data

Model Number	Input (MBTUH)	Efficiency AFUE		Cooling Capacity @ .5 in wc (125 Pa)	Dimensions H x W x D* (sq) in (mm)	Operating Weight lbs (kg)
		Canada	US			
OMF098J10B	70,000 - 98,000	84.0 - 87.0	83.3 - 86.4	2.5 ton	40-3/4 x 16-7/8 x 21-1/2 (1035 x 429 x 546)	125 (57)
OMF112K14A	95,200 - 112,000	85.5 - 87.1	85.3 - 85.8	3.5 ton	41-1/2 x 21-3/4 x 25-3/4 (1054 x 553 x 654)	153 (70)
OMF154L20A	126,000 - 154,000	85.3† - 87.0†	85.0† - 86.1†	5 ton	47-7/8 x 28-1/2 x 25 (1216 x 724 x 635)	200 (90)

* Depth without the burner

† Meets ENERGY STAR® Guidelines (Only specific firing rates meet the ENERGY STAR guidelines).

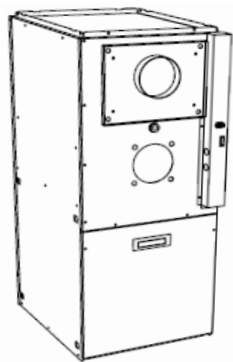

OMV

Hi-Boy Multi-Position, Variable-Speed Oil Furnace

Features

- Stainless steel, heavy gauge heat exchanger quickly transfers heat to the ambient air
- Multi-position, four way multi-poise unit that opens-up installation possibilities
- Low profile - OMV098 is 40-3/4" (1035 mm) high, OMV112 is 41-1/2" (1054 mm) high, OMF154 is 47-7/8" (1216 mm) high
- Sound attenuator, integrated inside secondary heat exchanger
- High density acoustic wool dampens combustion sound
- Variable-speed blower ECM motor that provides true constant CFM capabilities
- Dehumidification with variable-speed ECM motor allows modulation of blower speed to better extract humidity
- Choice of high static pressure oil burners: Beckett AFG and NX, Riello 40 (Burners must be ordered separately)
- Inspection port/clean outs external for easy access and sealed, adjust combustion parameters and simplify inspections parameters and perform inspections easily with this sealed, spring-loaded access port
- Approved for chimney vent and sealed combustion installations
- High quality, high-gloss baked finish
- Efficient AFUE up to 86.7% Canada, 86.3% US
- Front flue (breach)

Warranty*

- 10-year No Hassle Replacement™ limited warranty
- Lifetime heat exchanger limited warranty with timely registration
- Five-year parts limited warranty
 - With timely registration, an additional five-year parts limited warranty

* For residential applications only.
See warranty certificate for complete details and restrictions, including warranty coverage for other applications.

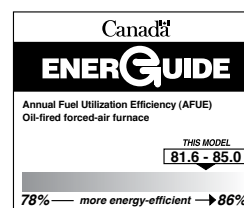

ONLY applies to applications in Canada where the furnace is installed in the conditioned space, per sections 5.35.1.2 and 4.7.1.1 of CSA standard B212 dated October 2000.

Unit Performance Data

Model Number	Input (MBTUH)	Efficiency AFUE		Cooling Capacity @ .5 in wc (125 Pa)	Dimensions H x W x D* (sq) in (mm)	Operating Weight lbs (kg)
		Canada	US			
OMV098J12B	70,000 - 98,000	87.0†	85.0† - 86.4†	3 ton	40-3/4 x 16-7/8 x 21-1/2 (1035 x 429 x 546)	125 (57)
OMV112K14A	95,200 - 112,000	85.5† - 87.1†	85.3† - 85.8†	3.5 ton	41-1/2 x 21-3/4 x 25-3/4 (1054 x 553 x 654)	153 (70)
OMV154L20A	126,000 - 154,000	85.3† - 87.0†	85.0† - 86.3	5 ton	47-7/8 x 28-1/2 x 25 (1216 x 724 x 635)	200 (90)

* Depth without the burner

† Meets ENERGY STAR® Guidelines (Only specific firing rates meet the ENERGY STAR guidelines).

OLR

Lo-Boy Upflow Oil Furnace

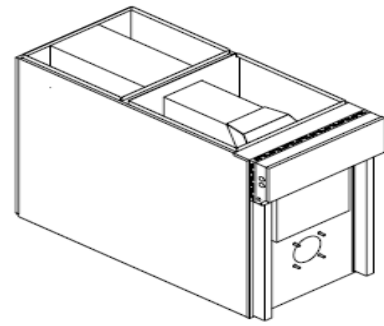

Features

- Stainless steel, heavy gauge heat exchanger quickly transfers heat to the ambient air
- Multi-speed direct drive motors permanently lubricated for long life performance
- Easy access control panel
- Low profile OLR098 is 33-3/4" (857mm) high, OLR112 is 33-3/4" (857mm) high, OLR154 is 39-1/4" (997mm) high
- Sound attenuator, high density acoustic wool dampens combustion sound
- Choice of high static pressure oil burners: Beckett AFG and NX, Riello 40 (burners must be ordered separately)
- Inspection port external for easy access and sealed, adjust combustion parameters and simplify inspections
- Accessories included, barometric draft regulator, internal filter rack and air filter
- High quality, high-gloss baked finish
- Efficient AFUE up to 87.0% Canada, 86.4% US
- Approved for chimney vent and sealed combustion installations

Warranty*

- Lifetime heat exchanger limited warranty with timely registration
- Five-year parts limited warranty
 - With timely registration, an additional five-year parts limited warranty

* For residential applications only. See warranty certificate for complete details and restrictions, including warranty coverage for other applications.

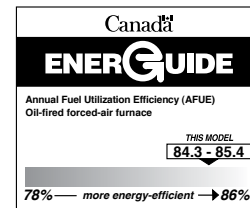

ONLY applies to applications in Canada where the furnace is installed in the conditioned space, per sections 5.35.1.2 and 4.7.1.1 of CSA standard B212 dated October 2000.

Unit Performance Data

Model Number	Input (MBTUH)	Efficiency AFUE		Cooling Capacity @ .5 in wc (125 Pa)	Dimensions H x W x D* (sq) in (mm)	Operating Weight lbs (kg)
		Canada	US			
OLR098A12A	77,000 - 98,000	85.4 - 87.9	85.0 - 86.9	3 ton	33-3/4 x 21 x 47 (857 x 533 x 1194)	175 (79)
OLR112A16A	95,200 - 112,000	86.4 - 88.1	85.9 - 87.2	4 ton	33-3/4 x 21 x 48 (857 x 533 x 1219)	195 (89)
OLR154F20A	126,000 - 154,000	86.1 - 87.7	85.5 - 87.5	5 ton	39-1/4 x 24-7/8 x 52 (997 x 632 x 1320)	270 (123)

* Depth without the burner



OLR 210

Lo-Boy Oil Furnace

Available in Canada Only

Features

- Fan control switch for continuous low speed
- Large external front clean out for easy cleaning
- Clean out sealed from blower compartment (no soot to spread)
- Easy access control panel
- Sight glass/view port
- Furnaces are available with your choice of high-efficiency Riello or Beckett burners (burners ordered and shipped separately)
- Easy access heat exchanger manufactured from heavy gauge steel
- Multi-speed direct drive motors permanently lubricated for long life performance
- Heavy-duty insulated cabinet for quiet operation
- Precision balanced blower ensures quiet, efficient air distribution
- Raised cabinet base allows air to circulate under the cabinet, eliminates dampness
- Efficient AFUE up to 86.7% Canada, 85.4% US
- OLR - Rear flue (breach)

Warranty*

- Lifetime heat exchanger limited warranty with timely registration
- Five-year parts limited warranty
 - With timely registration, an additional five-year parts limited warranty

* For residential applications only. See warranty certificate for complete details and restrictions, including warranty coverage for other applications.

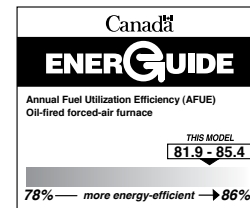

ONLY applies to applications in Canada where the furnace is installed in the conditioned space, per sections 5.35.1.2 and 4.7.1.1 of CSA standard B212 dated October 2000.

Unit Performance Data

Model Number	Input (MBTUH)	Efficiency AFUE		Cooling Capacity @ .5 in wc (125 Pa)	Dimensions H x W x D* (sq) in (mm)	Operating Weight lbs (kg)
		Canada	US			
OLR210F19C	168,000 - 210,000	84.6 - 86.7	83.1 - 85.4	5 ton	36-1/2 x 20-1/4 x 50-5/8 (918 x 533 x 1286)	240 (109)

* Depth without the burner

OLR350

Lo-Boy Upflow Oil Furnace



Features

- Fan control switch for continuous speed
- Large external rear clean out for easy cleaning
- Clean out sealed from blower compartment (no soot to spread)
- Easy access control panel
- Sight glass/view port
- Furnaces are available with your choice of high-efficiency Riello or Beckett burners (burners ordered and shipped separately)
- Easy access heat exchanger manufactured from heavy gauge steel
- Multi-speed direct drive motors permanently lubricated for long life performance
- Heavy-duty insulated cabinet for quiet operation
- Precision balanced blower ensures quiet, efficient air distribution
- Raised cabinet base allows air to circulate under the cabinet, eliminates dampness
- Efficient AFUE up to 81.5%
- Not air conditioning ready
- Rear flue (breach)

Warranty*

- Lifetime heat exchanger limited warranty with timely registration
- Five-year parts limited warranty
 - With timely registration, an additional five-year parts limited warranty

* For residential applications only. See warranty certificate for complete details and restrictions, including warranty coverage for other applications.

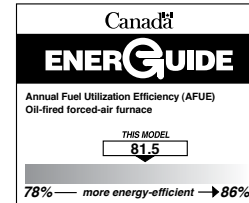

Unit Performance Data

Model Number	Input (MBTUH)	Efficiency AFUE		Dimensions H x W x D* (sq) in (mm)	Operating Weight lbs (kg)
		Canada	US		
OLR350H28B	245,000 - 350,800	81.5	81.5	46-7/8 x 26 x 66-7/8 (1191 x 660 x 1699)	400 (181)

* Depth without the burner.

Build to Order Only

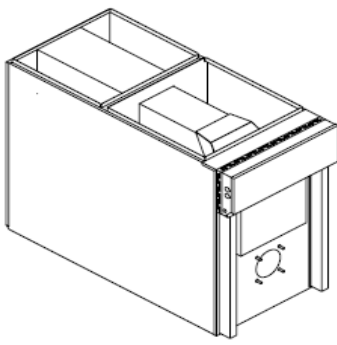

Features

- Stainless steel, heavy gauge heat exchanger quickly transfers heat to the ambient air
- Variable-speed ECM motor that provides true constant CFM capabilities
- Fan control switch for continuous operation
- Easy access control panel
- Low profile OLV098 is 33-3/4" (857 mm) high, OLV112 is 33-3/4" (857 mm) high, OLV154 is 39-1/4" (997mm) high
- Sound attenuator, high density acoustic wool dampens combustion sound
- Choice of high-efficiency, high-static pressure oil burners Riello or Beckett AFG and NX burners (burners ordered and shipped separately)
- Inspection port external for easy access and sealed, adjust combustion parameters and simplify inspections
- Accessories included, barometric draft regulator, internal filter rack and air filter
- High quality, high-gloss baked finish
- Efficient AFUE up to 88.1% Canada, 87.5% US
- Approved for chimney vent and sealed combustion installations

Warranty*

- 10-year No Hassle Replacement™ limited warranty
- Lifetime heat exchanger limited warranty with timely registration
- Five-year parts limited warranty
 - With timely registration, an additional five-year parts limited warranty

* Applies to original purchaser/homeowner, some limitations may apply. See warranty certificate for complete details.

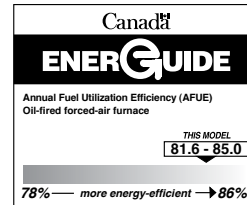

ONLY applies to applications in Canada where the furnace is installed in the conditioned space, per sections 5.35.1.2 and 4.7.1.1 of CSA standard B212 dated October 2000.

Unit Performance Data

Model Number	Input (MBTUH)	Efficiency AFUE		Cooling Capacity @ .5 in wc (125 Pa)	Dimensions H x W x D* (sq) in (mm)	Operating Weight lbs (kg)
		Canada	US			
OLV098A12A	70,000 - 98,000	85.4† - 87.0†	85.0† - 86.9†	3 ton	33-3/4 x 21 x 47 (857 x 533 x 1194)	175 (80)
OLV112A16A	81,100 - 112,000	86.4† - 88.1†	85.9† - 87.2†	4 ton	33-3/4 x 21 x 48 (857 x 533 x 1219)	195 (89)
OLV154F20A	107,700 - 154,000	86.1† - 87.7†	85.5† - 87.5†	5 ton	39-1/4 x 27-7/8 x 52 (997 x 632 x 1320)	270 (123)

* Depth without the burner.

† Meets ENERGY STAR® Guidelines

OTF210

Upflow/Horizontal Oil Furnace



Features

- Fan control switch for continuous speed
- Large external rear clean out for easy cleaning
- Clean out sealed from blower compartment (no soot to spread)
- Easy access control panel
- Sight glass/view port
- Furnaces are available with your choice of high-efficiency Riello or Beckett burners (burners ordered and shipped separately)
- Easy access heat exchanger manufactured from heavy gauge steel
- Multi-speed direct drive motors permanently lubricated for long life performance
- Heavy-duty insulated cabinet for quiet operation
- Precision balanced blower ensures quiet, efficient air distribution
- Raised cabinet base allows air to circulate under the cabinet, eliminates dampness
- Approved chimney vent applications
- Efficient AFUE up to 86.3% Canada, 85.0% US
- Air conditioning ready
- Front flue (breach)

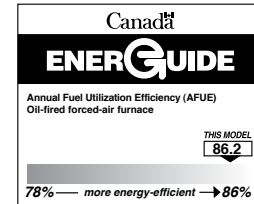

ONLY applies to applications in Canada where the furnace is installed in the conditioned space, per sections 5.35.1.2 and 4.7.1.1 of CSA standard B212 dated October 2000.

Unit Performance Data

Model Number	Input (MBTUH)	Efficiency AFUE		Cooling Capacity @ .5 in wc (125 Pa)	Dimensions H x W x D* (sq) in (mm)	Operating Weight lbs (kg)
		Canada	US			
OTF210G21B	68,000 - 210,000	84.4 - 86.3	82.9 - 85.0	5 ton	52-3/4 x 24-1/4 x 34 (1340 x 616 x 864)	250 (113)

* Depth without the burner

Accessories

Oil Furnaces

Model Number	Description	Used with Models
Oil Burners		
N01F034	Riello 40-BF3 Oil Burner for 5" Breech Models (Direct)	OLF105, OLR105, OUF105
N01F035	Riello 40-BF5 Oil Burner (Direct)	OLR160
N01F040	Riello 40-F5 Oil Burner	OTF210
N01F041	Riello 40 Oil Burner	OLR350
N01F049	Riello 40-F3 Oil Burner for 5" Breech Models (Chimney)	OLF105, OLR105, OUF105
N01F050	Riello 40-F5 Oil Burner for 6" Breech Models (Chimney)	OLR160
N01F051	Riello Oil Burner (Chimney)	OMF112, OMV112, OLR112, OLV112
N01F052	Riello Oil Burner (Direct)	OMF112, OMV112, OLR112, OLV112
N01F053	Riello Oil Burner (Chimney)	OLR154, OLV154
N01F054	Riello (Chimney Venting)	OMF098, OMV098, OLR098, OLV098
N01F055	Riello Oil Burner (Direct)	OMF098, OMV098, OLR098, OLV098
N01F056	Riello Oil Burner (Direct)	OLR154, OLV154
N01J038	Beckett AF11-85 Oil Burner for 5" Breech Models (Direct Vent)	OLF105, OLR105, OUF105
N01J039	Beckett AFG-F3 Oil Burner for 6" Breech Models (Chimney)	OLR160
N01J040	Beckett AFG-F0 Oil Burner for 5" Breech Models (Chimney)	OLF105, OLR105, OUF105
N01J041	Beckett AF11-150 Oil Burner for 6" Breech Models (Direct Vent)	OLR160
N01J045	Beckett AFG-F6 Oil Burner (Shipped with Nozzle 1.25 - 70W)	OTF210
N01J046	Riello 40 Oil Burner	OLR350
N01J050	Beckett NX Oil Burner	OMF098, OLR098, OLV098, OMV098
N01J052	Beckett NX Oil Burner	OMF112, OLR112, OLV112, OMV112
N01J053	Beckett Oil Burner (Chimney or Direct)	OLR154, OLV154, OMF154, OMV154
Nozzles		
N03F014	Nozzle, Oil Burner, Delavan, 0.50 GPH/60° A (w/burner)	OLR105, OLF105, OUF105, OMF098, OMV098, OLR098, OLV098
N03F015	Nozzle, Oil Burner, Delavan, 0.50 GPH/70° A Riello (w/burner)	OLR105, OLF105, OUF105, OMF098, OMV098, OLR098, OLV098, OMF112, OMV112
N03F018	Nozzle, Oil Burner, Delavan, 0.40 GPH/70° A Riello	OMF098, OMV098
N03F027	Nozzle, Oil Burner, Delavan, 0.40 GPH/70° A Beckett	OMF098, OMV098, OLF105, OLR105
N03G010	Nozzle, Oil Burner, Delavan, 0.50 GPH/60° W	OLF105, OLR105, OUF105
N03G011	Nozzle, Oil Burner, Delavan, 0.60 GPH/60° W	OLF105, OLR105, OUF105, OLF140
N03G012	Nozzle, Oil Burner, Delavan, 1.00 GPH/70° W	OLR350, OTF210, OLF140, OLR210
N03G013	Nozzle, Oil Burner, Delavan, 1.10 GPH/70° W	OTF210, OLR210
N03H001	Nozzle, Oil Burner, Delavan, 1.00 GPH/70° B	OLR160
N03H008	Nozzle, Oil Burner, Delavan, 0.85 GPH/70° B	OLR160
N03H013	Nozzle, Oil Burner, Delavan, 0.75 GPH/70° B	OLR160
N03H014	Nozzle, Oil Burner, Delavan, 0.60 GPH/70° B	OUF105, OLR105, OLF105

Accessories

Oil Furnaces

Model Number	Description	Used with Models
Vestibule Kits		
LBVEST1M	Vestibule Kit for 5" Breech Low Boy Models	OLF105, OLR105, NOLF105
LBVEST2M	Vestibule Kit for 6" Breech Low Boy Models	OLR160
HBVEST1M	Vestibule Kit for 5" Breech High Boy Models	OUR105
Vent Terminal Kits		
VTK1	Vent Terminal Kit for 5" Breech Models	OLF105, OLR105, OUF105
VTK2	Vent Terminal Kit for 6" Breech Models	OLR160
IFV323	3" Ø x 20' (76 mm x 7 m) Insulated Flex Vent for 5" Breech Models	OLF105, OLR105, OUF105
IFV415	4" Ø x 15' (102 mm x 4.6 m) Insulated Flex Vent for 6" Breech Models	OLR160
IFV423	4" Ø x 20' (102 mm x 7 m) Insulated Flex Vent for 6" Breech Models	OLR160
IFV508	5" Ø x 10' (127 mm x 2.4 m) Insulated Flex Vent for 8' Breech Models	OLR154, OLV154, OMF154, OMV154
IFV520	5" Ø x 20' (127 mm x 6 m) Insulated Flex Vent for 20' Breech Models	OLR154, OLV154, OMF154, OMV154
IFV09820	4" Ø x 20' (102 mm x 6 m) Insulated Flex Vent for 4" Breech Models	OMF098, OMV098, OLR098, OLV098, OLR112, OLV112, OMF112, OMV112
Floor Base		
DFB102	Downflow Subbase	OMF098, OMV098
DFB103	Downflow Subbase	OMF112, OMV112
DFB104	Downflow Subbase	OMF154, OMV154
FRB101	Floor Return Base	OMF098, OMV098
Coil Adapter		
OCA20	Oil Coil Adapter (Cased Coil Adapter, (20" x 20"))	OLR105, OLF105, OUF105, NOLF105
OCA24	Oil Coil Adapter (Cased Coil Adapter, (24" x 24"))	OLR160
Additional Accessories		
B30083	External Filter Rack 20" x 20"	OUF105
CAS2B	Outside Air Intake for NO1J040	OLF105, OLR105, OUF105, OLR160
CAD1	25' Flexible Air Duct for CAS2B	OLF105, OLR105, OUF105, OLR160
Z06F007	Draft Regulator	OTF210
C7001025	Riello Two-Pipe Change Over Kit	OLF105, OLR105
Z08F001+	7 Micron Media Filter and Head	OLF, OLR, OCF, OUF
Z08F004+	7 Micron Media Filter	OLF, OLR, OCF, OUF

+ Must be ordered from Service Parts

Fan Coils, Evaporator Coils and Blower Coils



FCM4X

Fan Coils with Observer® Communicating Control System

2 – 5 Tons



Recommended
(Sold separately)



Features

- Easier troubleshooting, providing faster service and repair
- Multi-position installation
- Communicating, self configuring when used with Observer Communicating Wall Control
- Aluminum tube, aluminum fin evaporator coil
- Bi-flow hard-shutoff R-410A TXV metering device
- HUD approved for manufactured housing
- Sweat connections
- Primary and secondary brass drain connections
- Energy-efficient variable-speed ECM Motor
- Ultra-low power consumption during fan only operation
- High duct static capability
- Pre-painted galvanized sheet metal cabinet insulation with vapor barrier
- Cabinet construction designed to prevent cabinet sweating
- Meets requirements of a 2% cabinet leakage rate when tested at 1-inch water column of static pressure
- Modular cabinet on 5-ton model
- 208/230-1-60 supply voltage
- Multiple electrical entry for application flexibility
- Low voltage terminal strip
- Easy plug connection provided for quick installation of accessory heater packages
- Factory supplied washable filter easily removed
- no tools required

Warranty*

- 10-year No Hassle Replacement™ limited warranty
- Five-year parts limited warranty
 - With timely registration, an additional five-year parts limited warranty

* For residential applications only.
See warranty certificate for complete details and restrictions, including warranty coverage for other applications.

Unit Performance Data

Model Number	Size (tons)	Nominal Btu/hr	CFM (L/s)	Operating Dimensions H x W x D (sq) in (mm)	Filter Size in (mm)	Shipping Weight lbs (kg)
FCM4X2400AL	2	24,000	800 (378)	42-11/16 x 17-5/8 x 22-1/16 (1084 x 448 x 560)	16-3/8 x 21-1/2 (416 x 546)	135 (61)
FCM4X3600AL	3	36,000	1200 (566)	53-7/16 x 21-1/8 x 22-1/16 (1357 x 537 x 560)	19-7/8 x 21-1/2 (505 x 546)	150 (68)
FCM4X4800AL	4	48,000	1600 (755)	53-7/16 x 21-1/8 x 22-1/16 (1357 x 537 x 560)	19-7/8 x 21-1/2 (505 x 546)	172 (78)
FCM4X6000AL	5	60,000	1750 (826)	59-3/16 x 24-11/16 x 22-1/16 (1503 x 627 x 560)	23-5/16 x 21-1/2 (592 x 546)	207 (94)



FVM4X

Variable-Speed Fan Coils

2 – 5 Tons

Features

- Supports two-stage outdoor units
- Available for Environmentally Sound R-410A systems
- Bolt-on, hard shut-off TXV metering device factory installed on all models
- Aluminum tube, aluminum fin evaporator coil
- Sweat connections
- Primary and secondary drain fittings with brass inserts
- Time delay relay (TDR)
- Field installed heater packages from 5 kW - 30 kW available separately
- HUD approved for manufactured housing
- 208/230-1-60 supply voltage
- Multi-position installation – upflow or horizontal left standard, horizontal right with minor modification (field convertible to downflow with accessory kits)
- Filter (washable) factory supplied
- Heat staging option
- Dehumidification function with standardized logic
- One-inch (25 mm) thick insulation with R value of 4.2

Performance

- Variable-speed ECM motor on all models
- Adjustable cooling and heating on/off delay
- Heat Pump Comfort option to provide higher than normal heating air delivery temperature
- Units tested and certified by manufacturer to achieve a 2% or less leakage rate of 1-inch water column

Easy-to-Install and Service

- Multiple electrical entry locations
- TXV and manifold positioned to the side for easier cleaning
- Zero clearance without heaters

Warranty*

- 10-year No Hassle Replacement™ limited warranty
- Five-year parts limited warranty – With timely registration, an additional five-year parts limited warranty

* For residential applications only. See warranty certificate for complete details and restrictions, including warranty coverage for other applications.

Unit Performance Data

Model Number	Size (tons)	Nominal Btu/hr	CFM (L/s) Range		Operating Dimensions H x W x D (sq) in (mm)	Filter Size in (mm)	Shipping Weight lbs (kg)
			Low	High			
FVM4X2400BL	2	24,000	350 (165)	1200 (566)	42-11/16 x 17-5/8 x 22-1/16 (1084 x 448 x 560)	16-3/8 x 21-1/2 (416 x 546)	135 (61)
FVM4X3600BL	3	36,000	415 (196)	1400 (661)	53-7/16 x 21-1/8 x 22-1/16 (1357 x 537 x 560)	19-7/8 x 21-1/2 (505 x 546)	150 (68)
FVM4X4800BL	4	48,000	425 (201)	1600 (755)	53-7/16 x 21-1/8 x 22-1/16 (1357 x 537 x 560)	19-7/8 x 21-1/2 (505 x 546)	172 (78)
FVM4X6000BL	5	60,000	540 (255)	2000 (944)	59-3/16 x 24-11/16 x 22-1/16 (1503 x 627 x 560)	23-5/16 x 21-1/2 (592 x 546)	207 (94)

FXM4X

Fan Coils

1-1/2 – 5 Tons
Environmentally Sound R-410A Systems



Features

- TXV metering device factory installed
- ECM five-speed motor
- Sweat connections
- Primary and secondary drain fittings with brass inserts
- Three amp automotive type fuse in wire harness
- Multiple electrical entry locations
- Time delay relay (TDR) programmed in motor
- Field installed heater packages from 5 kW – 30 kW available separately
- HUD approved for manufactured housing
- 208/230-1-60 supply voltage
- Units tested and certified by manufacturer to achieve a 2% or less leakage rate at 1-inch water column
- One-inch thick insulation with R value of 4.2
- Multi-position installation – upflow or horizontal left standard, horizontal right with minor modification (field convertible to downflow with available accessory kits)
- No Heat (Plug) Kit factory installed
- Filter (washable) factory supplied

Warranty*

- Five-year No Hassle Replacement™ limited warranty
- Five-year parts limited warranty
 - With timely registration, an additional five-year parts limited warranty

* For residential applications only.
See warranty certificate for complete details and restrictions, including warranty coverage for other applications.

Unit Performance Data

Model Number	Size (tons)	Nominal Btu/hr	CFM (L/s)	Operating Dimensions H x W x D (sq) in (mm)	Filter Size in (mm)	Shipping Weight lbs (kg)
FXM4X1800A	1-1/2	18,000	600 (283)	49-5/8 x 17-5/8 x 22-1/16 (1261 x 448 x 560)	16-3/8 x 21-1/2 (416 x 546)	122 (55)
FXM4X1800AL	1-1/2	18,000	600 (283)	49-5/8 x 17-5/8 x 22-1/16 (1261 x 448 x 560)	16-3/8 x 21-1/2 (416 x 546)	122 (55)
FXM4X2400AL	2	24,000	800 (378)	49-5/8 x 17-5/8 x 22-1/16 (1261 x 448 x 560)	19-7/8 x 21-1/2 (505 x 546)	122 (55)
FXM4X3000AL	2-1/2	30,000	1000 (472)	53-7/16 x 21-1/8 x 22-1/16 (1357 x 537 x 560)	19-7/8 x 21-1/2 (505 x 546)	146 (66)
FXM4X3600AL	3	36,000	1200 (566)	49-5/8 x 21-1/8 x 22-1/16 (1261 x 537 x 560)	19-7/8 x 21-1/2 (505 x 546)	157 (71)
FXM4X4200AL	3-1/2	42,000	1400 (661)	49-5/8 x 21-1/8 x 22-1/16 (1261 x 537 x 560)	23-5/16 x 21-1/2 (592 x 546)	157 (71)
FXM4X4800AL	4	48,000	1600 (755)	53-7/16 x 24-11/16 x 22-1/16 (1357 x 627 x 560)	23-5/16 x 21-1/2 (592 x 546)	185 (84)
FXM4X6000AL	5	60,000	2000 (944)	59-3/16 x 24-11/16 x 22-1/16 (1503 x 627 x 560)	23-5/16 x 21-1/2 (592 x 546)	201 (91)

A = Coppertube, Aluminum Fin Evaporator Coil
AL = Aluminum Tube, Aluminum Fin Evaporator Coil



FEM4P

Fan Coils

1-1/2 – 4 tons
Environmentally Sound R-410A Systems

Features

- Factory installed piston metering device with Teflon® ring
- ECM five-speed motor
- Sweat connections
- Aluminum tube, aluminum fin evaporator
- Primary and secondary drain fittings with brass inserts
- Low voltage circuit protective fuse (3 amp) inline on wire harness
- Multiple electrical entry locations
- Time delay relay (TDR)
- Field installed heater packages from 5 kW – 30 kW available separately
- HUD approved for manufactured housing
- 208/230-1-60 supply voltage
- Units tested and certified by manufacturer to achieve a 2% or less leakage rate at 1-inch water column
- One-inch thick insulation with R value of 4.2
- Multi-position installation – upflow or horizontal left standard, horizontal right with minor modification (field convertible to downflow with available accessory kits)
- No Heat (Plug) Kit factory installed
- Filter (washable) factory supplied

Warranty*

- One-year No Hassle Replacement™ limited warranty
- Five-year parts limited warranty
 - With timely registration, an additional five-year parts limited warranty

* For residential applications only.
See warranty certificate for complete details and restrictions, including warranty coverage for other applications.

Unit Performance Data

Model Number	Size (tons)	CFM (L/s)	Operating Dimensions H x W x D (sq) in (mm)	Filter Size in (mm)	Shipping Weight lbs (kg)
FEM4P1800AL	1-1/2	600 (283)	42-11/16 x 14-5/16 x 22-1/16 (1084 x 364 x 560)	13 x 21-1/2 (330 x 546)	112 (51)
FEM4P2400AL	2	800 (378)	42-11/16 x 14-5/16 x 22-1/16 (1084 x 364 x 560)	13 x 21-1/2 (330 x 546)	112 (51)
FEM4P3000AL	2-1/2	1000 (472)	49-5/8 x 17-5/8 x 22-1/16 (1261 x 448 x 560)	16-3/8 x 21-1/2 (416 x 546)	122 (55)
FEM4P3600AL	3	1200 (566)	49-5/8 x 17-5/8 x 22-1/16 (1261 x 448 x 560)	16-3/8 x 21-1/2 (416 x 546)	122 (55)
FEM4P4200AL	3-1/2	1400 (661)	49-5/8 x 21-1/8 x 22-1/16 (1261 x 537 x 560)	19-7/8 x 21-1/2 (505 x 546)	157 (71)
FEM4P4800AL	4	1600 (755)	49-5/8 x 21-1/8 x 22-1/16 (1261 x 537 x 560)	19-7/8 x 21-1/2 (505 x 546)	157 (71)

FEM4X

Fan Coils



1-1/2 – 5 Tons Environmentally Sound R-410A Systems

Features

- Available for environmentally sound R-410A systems
- Factory installed TXV metering device
- Sweat connections
- Aluminum tube, aluminum fin evaporator
- Primary and secondary drain fittings with brass inserts
- Multiple electrical entry locations
- Time delay relay (TDR)
- Field installed heater packages from 5 kW – 30 kW available separately
- HUD approved for manufactured housing
- 208/230-1-60 supply voltage
- Units tested and certified by manufacturer to achieve a 2% or less leakage rate at 1-inch water column
- One-inch thick insulation with R value of 4.2
- ECM five-speed motor
- Multi-position installation – upflow or horizontal left standard, horizontal right with minor modification (field convertible to downflow with available accessory kit)
- Low voltage circuit protective fuse (3 amp) inline on wire harness
- No Heat (Plug) Kit factory installed
- Filter (washable) available as accessory

Warranty*

- One-year No Hassle Replacement™ limited warranty
- Five-year parts limited warranty
 - With timely registration, an additional five-year parts limited warranty

* For residential applications only.
See warranty certificate for complete details and restrictions, including warranty coverage for other applications.

Unit Performance Data

Model Number	Size (tons)	Nominal CFM (L/s)	Operating Dimensions H x W x D (sq) in (mm)	Filter Size in (mm)	Shipping Weight lbs (kg)
FEM4X1800BL	1-1/2	600 (283)	42-11/16 x 14-5/16 x 22-1/16 (1084 x 364 x 560)	13 x 21-1/2 (330 x 546)	112 (51)
FEM4X2400CL	2	800 (378)	49-5/8 x 17-5/8 x 22-1/16 (1261 x 448 x 560)	16-3/8 x 21-1/2 (416 x 546)	122 (55)
FEM4X3000BL	2-1/2	1000 (472)	49-5/8 x 17-5/8 x 22-1/16 (1261 x 448 x 560)	16-3/8 x 21-1/2 (416 x 546)	122 (55)
FEM4X3600BL	3	1200 (566)	49-5/8 x 17-5/8 x 22-1/16 (1261 x 448 x 560)	16-3/8 x 21-1/2 (416 x 546)	122 (55)
FEM4X4200BL	3-1/2	1400 (661)	49-5/8 x 21-1/8 x 22-1/16 (1261 x 537 x 560)	19-7/8 x 21-1/2 (505 x 546)	157 (71)
FEM4X4800BL	4	1600 (755)	49-5/8 x 21-1/8 x 22-1/16 (1261 x 537 x 560)	19-7/8 x 21-1/2 (505 x 546)	157 (71)
FEM4X6000BL	5	1750 (826)	53-7/16 X 21-1/8 X 22-1/16 (1357 X 537 X 560)	19-7/8 x 21-1/2 (505 x 546)	175 (79)



FMA4X, FMA4P

Apartment Fan Coils

1-1/2 – 3 Tons

All Models

- Upflow application only
- Accessory field installed electric heat kits available in 5, 7.5, or 10 kW
- 208/230-1-60 supply voltage
- Front return convertible to bottom return
- Cabinet exterior is galvanized sheet metal
- Sealed to meet 2% cabinet leakage when tested at 1.0 in water column of static pressure
- Fully insulated for conditioned space (not to be installed in unconditioned spaces)

FMA4P

- For use with R-410A refrigerant or R-22 with accessory R-22 TXV

FMA4X

- R-410A refrigerant TXV standard or for use with R-22 with accessory R-22 TXV

Performance

- PSC motor on all FMA4P
- ECM motor on all FMA4X
- Motor suspended on rubber grommets for quieter operation
- Fresh air intake holes (capped from factory)

Warranty*

- Five-year parts limited warranty – With timely registration, an additional five-year parts limited warranty

* For residential applications only. See warranty certificate for complete details and restrictions, including warranty coverage for other applications.

Easy-to-Install and Service

- Units fit between standard stud spacings
- All service access is located in the front
- Primary and secondary drain connections exit from the bottom
- No return air ductwork required in specific applications
- Wall hanging brackets included with the unit

Unit Performance Data

Model Number	Size (tons)	Nominal BTU	Nominal CFM (L/s)		Operating Dimensions H x W x D (sq) in (mm)	Filter Size in (mm)	Shipping Weight lbs (kg)
FMA4P1800AT	1-1/2	18,000	450 (212)	675 (319)	36-1/2 x 20-1/2 x 15 (928 x 521 x 381)	16 x 20 (406 x 508)	99 (45)
FMA4P2400AT	2	24,000	600 (283)	900 (425)	36-1/2 x 20-1/2 x 15 (928 x 521 x 381)	16 x 20 (406 x 508)	99 (45)
FMA4P3000AT	2-1/2	30,000	750 (354)	1125 (531)	39-1/2 x 22 x 19 (1004 x 559 x 483)	20 x 20 (508 x 508)	121 (55)
FMA4P3600AT	3	36,000	900 (425)	1350 (637)	39-1/2 x 22 x 19 (1004 x 559 x 483)	20 x 20 (508 x 508)	121 (55)
FMA4X1800AT	1-1/2	18,000	450 (212)	675 (319)	36-1/2 x 20-1/2 x 15 (928 x 521 x 381)	16 x 20 (406 x 508)	99 (45)
FMA4X2400AT	2	24,000	600 (283)	900 (425)	36-1/2 x 20-1/2 x 15 (928 x 521 x 381)	16 x 20 (406 x 508)	99 (45)
FMA4X3000AT	2-1/2	30,000	750 (354)	1125 (531)	39-1/2 x 22 x 19 (1004 x 559 x 483)	20 x 20 (508 x 508)	121 (55)
FMA4X3600AT	3	36,000	900 (425)	1350 (637)	39-1/2 x 22 x 19 (1004 x 559 x 483)	20 x 20 (508 x 508)	121 (55)

AT = Tin-Plated Copper Tube, Aluminum Fin

Specifications subject to change without notice.

FMU4X, FMU4P, FMC4X, FMC4P

Horizontal Fan Coils

1-1/2 – 3 Tons

FMU4P and FMC4P – 1-1/2, 2, 2-1/2, and 3 Tons

FMU4X and FMC4X – 1-1/2, 2, and 2-1/2 Tons

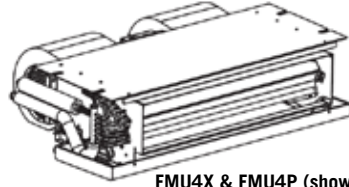

FMU4X & FMU4P (shown) –
Uncased Horizontal Fan Coil

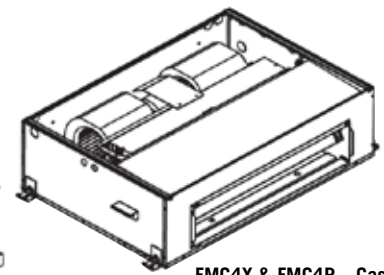

FMC4X & FMC4P – Cased
Horizontal Fan Coil (unit
pictured upside down)

All Models

- Horizontal application only
- For use with R-410A refrigerant or R-22 with accessory TXV
- Accessory field installed electric heat kits available in 3, 5, 6, 7.5, or 10 kW
- 40 VA 208/230-1-60 supply voltage
- FMU4P and FMC4P use R-410A piston metering device
- FMU4X and FMC4X use R-410A TXV metering device
- R-22 capable with accessory R-22 TXV

FMC4X and FMC4P

- Horizontal return applications require field fabricated bottom cover
- Cabinets meet the requirement of 2% cabinet leakage rate at 1-inch water column of static pressure
- Cabinets constructed to prevent cabinet sweating
- Refrigerant lines and electrical connections can be run out the back or side of casing
- Primary and secondary drain connections exit from the back or side of the cabinet

Performance

- PSC motor on all models

Easy-to-Install and Service

- A-coil design for maximum surface area
- Multiple electrical, refrigerant lineset and drain line entry for application flexibility
- Primary and secondary drain connections exit from the back or side of the cabinet
- Supports furred-down ceiling open return and ducted return applications
- Sweat connections for long term reliability
- Grooved copper tube/aluminum fin coils

Warranty*

- Five-year parts limited warranty – With timely registration, an additional five-year parts limited warranty

* For residential applications only. See warranty certificate for complete details and restrictions, including warranty coverage for other applications.

Unit Performance Data

Model Number	Size (tons)	Nominal CFM (L/s)	Operating Dimensions H x W x D (sq) in (mm)	Shipping Weight lbs (kg)
Uncased				
FMU4P1800AT	1-1/2	600 (283)	10-1/4 x 37-1/4 x 26-3/8 (260 x 946 x 670)	75 (34)
FMU4P2400AT	2	800 (378)	10-1/4 x 37-1/4 x 26-3/8 (260 x 946 x 670)	75 (34)
FMU4P3000AT	2-1/2	1000 (472)	10-1/4 x 49-1/4 x 26-3/8 (260 x 1251 x 670)	93 (42)
FMU4P3600AT	3	1200 (566)	10-1/4 x 49-1/4 x 26-3/8 (260 x 1251 x 670)	93 (42)
FMU4X1800AT	1-1/2	600 (283)	10-1/4 x 37-1/4 x 26-3/8 (260 x 946 x 670)	75 (34)
FMU4X2400AT	2	800 (378)	10-1/4 x 37-1/4 x 26-3/8 (260 x 946 x 670)	75 (34)
FMU4X3000AT	2-1/2	1000 (472)	10-1/4 x 49-1/4 x 26-3/8 (260 x 1251 x 670)	93 (42)
Cased				
FMC4P1800AT	1-1/2	600 (283)	11 x 39-3/4 x 27-3/4 (282 x 1010 x 704)	109 (49)
FMC4P2400AT	2	800 (378)	11 x 39-3/4 x 27-3/4 (282 x 1010 x 704)	109 (49)
FMC4P3000AT	2-1/2	1000 (472)	11 x 51-3/4 x 27-3/4 (282 x 1315 x 704)	135 (61)
FMC4P3600AT	3	1200 (566)	11 x 51-3/4 x 27-3/4 (282 x 1315 x 704)	135 (61)
FMC4X1800AT	1-1/2	600 (283)	11 x 39-3/4 x 27-3/4 (282 x 1010 x 704)	109 (49)
FMC4X2400AT	2	800 (378)	11 x 39-3/4 x 27-3/4 (282 x 1010 x 704)	109 (49)
FMC4X3000AT	2-1/2	1000 (472)	11 x 51-3/4 x 27-3/4 (282 x 1315 x 704)	135 (61)

AT = Tin-Plated Copper Tube, Aluminum Fin

Accessories

Fan Coil (Piston)

Part Number	Description	Use With FEM4P
EBAC01DSC	Disconnect Kit	Use with All Single-Phase Heaters 5kW – 10kW
EBAC01NCB	Downflow Base Kit	1800, 2400
EBAC02NCB	Downflow Base Kit	3000, 3600
EBAC03NCB	Downflow Base Kit	4200, 4800
EBAC01DFS	Downflow Conversion Kit – Slope Coil	1800, 2400, 3000, 3600
EBAC02DFA	Downflow Conversion Kit – “A” Coil	4200, 4800
EBAC01SPK	Single Point Wiring Kit	Only for use with 15kW and 20kW Fused Heaters
EBAC01FKS	Filter Kit (washable, box of 12)	1800, 2400
EBAC01FKM	Filter Kit (washable, box of 12)	3000, 3600
EBAC01FKL	Filter Kit (washable, box of 12)	4200, 4800
EBAC01PLG	No Heat (Plug) Kit (box of six)	FEM4P – ALL (Factory Installed)
EBAC01GSK	Downflow Gasket Kit	ALL (required for horizontal right and downflow)
NAEA20101TX	TXV Kit, R-22, Copper and Tin Coils Only	1800, 2400, 3000, 3600, 4200
NAEA20201TX	TXV Kit, R-22, Copper and Tin Coils Only	4800
NAEA40501TX	TXV Kit, R-410A, Copper and Tin Coils Only	1800, 2400, 3000
NAEA40601TX	TXV Kit, R-410A, Copper and Tin Coils Only	3600, 4200
NAEA40701TX	TXV Kit, R-410A, Copper and Tin Coils Only	4800
NAEB40501TX	TXV Kit, R-410A, Aluminum Coils Only	1800AL, 2400AL, 3000AL
NAEB40601TX	TXV Kit, R-410A, Aluminum Coils Only	3600AL, 4200AL
NAEB40701TX	TXV Kit, R-410A, Aluminum Coils Only	4800AL
NAEB20101TX	TXV Kit, R-22, Aluminum Coils Only	1800AL, 2400AL, 3000AL, 3600AL, 4200AL
NAEB20201TX	TXV Kit, R-22, Aluminum Coils Only	4800AL
NASA00201FR	16" X 20" X 1" (406 X 508 X 250 mm)	3000, 3600
NASA00301FR	20" X 20" X 1" (508 X 508 X 250 mm)	4200, 4800
Electric Heaters for FEM4P		
EHK05AKN	5 kW, Single-Phase, No Internal Circuit Protection	ALL
EHK05AKB	5 kW, Single-Phase with Circuit Breakers	ALL
EHK07AKN	8 kW, Single-Phase, No Internal Circuit Protection	ALL
EHK07AKB	8 kW, Single-Phase with Circuit Breakers	ALL
EHK09AKCN	9 kW, Supplied as Single-Phase, Field Convertible to Three-Phase, No Internal Circuit Protection	3600, 4200, 4800
EHK10AKN	10 kW, Single-Phase, No Internal Circuit Protection	ALL
EHK10AKB	10 kW, Single-Phase with Circuit Breakers	ALL
EHK15AKF	15 kW, Single-Phase with Fuses	2400, 3000, 3600, 4200, 4800
EHK15AKB	15 kW, Single-Phase with Circuit Breakers	2400, 3000, 3600, 4200, 4800
EHK15AHN	15 kW, Three-Phase, No Internal Circuit Protection	3600, 4200, 4800

Accessories

Fan Coil (Piston)

Electric Heaters for FEM4P		
Part Number	Description	Use With
EHK18AHN	18kW, Three-Phase, No Internal Circuit Protection	4200, 4800
EHK20AKF	20 kW, Single-Phase with Fuses	3000, 3600, 4200, 4800
EHK20AKB	20 kW, Single-Phase with Circuit Breakers	3000, 3600, 4200, 4800
EHK25AHCF	24 kW, Supplied as Three-Phase, Field Convertible to Single-Phase with Fuses	4800
EHK30AHCF	30 kW, Supplied as Three-Phase, Field Convertible to Single-Phase with Fuses	4800
Accessories for use with FMA4P		
AMWK001WG	Louvered Wall Panel with Frame (6 Pack)	18, 24
AMWK002WG	Louvered Wall Panel with Frame (6 Pack)	30, 36
NAEA20101TX	TXV Kit, R-22	18, 24, 30, 36
NAEA40501TX	TXV Kit, R-410A	18, 24, 30
NAEA40601TX	TXV Kit, R-410A	36
Electric Heaters for FMA4P		
EHK205B	5 kW, Single-Phase	ALL
EHK208B	7.5 kW, Single-Phase	ALL
EHK210B	10 kW, Single-phase	ALL
Accessories for use with FMU4P and FMC4P		
NASA00101GF	Louvered Wall Panel with Filter Rack – Small	18, 24
NASA00201GF	Louvered Wall Panel with Filter Rack – Large	30, 36
NASA00101CC	Access Panel – Small	18, 24
NASA00201CC	Access Panel – Large	30, 36
NAEA20101TX	TXV Kit, R-22	18, 24, 30, 36
NAEA40501TX	TXV Kit, R-410A	18, 24, 30
NAEA40601TX	TXV Kit, R-410A	36
Electric Heaters for use with FMU4P and FMC4P		
EHK305B	5 kW, Single-Phase	ALL
EHK308B	7.5 kW, Single-Phase	ALL
EHK310B	10 kW, Single-phase	ALL

Accessories

Fan Coil (TXV)

Part Number	Description	FCM4X	FVM4X	FXM4X	FEM4X
EBAC01DSC	Disconnect Kit	Use with all single-phase heaters 5 kW – 10kW			
EBAC01NCB	Downflow Base Kit	2400, 3600, 4800	–	–	1800B, 2400B
EBAC02NCB	Downflow Base Kit	–	2400	1800, 2400	2400C, 3000B, 3600B
EBAC03NCB	Downflow Base Kit	–	3600, 4800	3000, 3600, 4200	4200B, 4800B, 6000B
EBAC04NCB	Downflow Base Kit	6000B	6000B	4800, 6000	–
EBAC01DFS	Downflow Conversion Kit – Slope Coil	3600	3600	1800, 2400, 3000	1800B, 2400C, 3000B, 3600B
EBAC02DFA	Downflow Conversion Kit – A-Coil	2400, 4800, 6000	2400, 4800, 6000	3600, 4200, 4800, 6000	4200B, 4800B, 6000B
EBAC01SPK	Single Point Wiring Kit	Only for use with 15 kW and 20 kW fused heaters			
QOU14100JBAF	Single Point Wiring Kit – Square D® – Jumper Bar Assembly	Only for use with EHK15AKB and EHK20AKB breaker heaters			
EBAC01FKS	Filter Kit (Washable, Box of 12)	–	–	–	1800B
EBAC01FKM		2400*	2400*	1800*, 2400*	2400C, 3000B, 3600B
EBAC01FKL		3600*, 4800*	3600*, 4800*	3000*, 3600*, 4200*	4200B*, 4800B*, 6000B
EBAC01FKX		6000B	6000B	4800, 6000	–
NASA00101FR	12" X 20" x 1" (306 x 508 x 250 mm)	–	–	–	1800B
NASA00201FR	16" X 20" x 1" (406 x 508 x 250 mm)	2400	2400	1800, 2400	2400C, 3000B, 3600B
NASA00301FR	20" X 20" x 1" (508 x 508 x 250 mm)	3600, 4800	3600, 4800	3000, 3600, 4200	4200B, 4800B, 6000B
NASA00401FR	Standard Filter Rack (qty 2) (12" x 20" x 1" filter required)	6000B	6000B	4800, 6000	–
EBAC01PLG	No Heat (Plug) Kit (Box of 6)	ALL (factory installed)			
EBAC01GSK	Horizontal and Downflow Gasket Kit	ALL (required for horizontal right only)		ALL (required for horizontal right and downflow)	
NAEA20101TX	TXV Kit, R-22, Copper and Tin Coils Only	2400, 3600	2400, 3600	1800, 2400, 3000, 3600, 4200	1800, 2400, 3000, 3600, 4200
NAEA20201TX		4800	4800	4800	4800, 6000
NAEA20301TX		6000	6000	6000	–
NAEB20101TX	TXV Kit, R-22, Aluminum Coils Only	2400AL, 3600AL	2400AL, 3600AL	1800AL, 2400AL, 3000AL, 3600AL, 4200AL	1800BL, 2400CL, 3000BL, 3600BL, 4200BL
NAEB20201TX		4800AL	4800AL	4800AL	4800AL
NAEB20301TX		6000AL	6000AL	6000AL	6000BL

*Factory Supplied

Accessories

Fan Coil (TXV)

EHC Electric Heaters for FCM4X		
Part Number	Description	Use with
EHC09AKCN	9 kW, Supplied as Single-Phase, No Internal Circuit Protection	ALL
EHC15AKF	15 kW, Single-Phase with Fuses	ALL
EHC15AKB	15 kW, Single-Phase with Circuit Breakers	ALL
EHC20AKF	20 kW, Single-Phase with Fuses	ALL
EHC20AKB	20 kW, Single-Phase with Circuit Breakers	ALL
EHC25AHCF	25 kW, Supplied as Three-Phase, Field Convertible to Single-Phase with Fuses	ALL
EHC30AHCF	30 kW, Supplied as Three-Phase, Field Convertible to Single-Phase with Circuit Breakers	4800, 6000
EHK Electric Heaters for FCM4X		
EHK05AKN	5 kW, Single-Phase, No Internal Circuit Protection	ALL
EHK05AKB	5 kW, Single-Phase with Circuit Breakers	ALL
EHK07AKN	8 kW, Single-Phase, No Internal Circuit Protection	ALL
EHK07AKB	8 kW, Single-Phase with Circuit Breakers	ALL
EHK09AKCN	9 kW, Supplied as Single-Phase, Field Convertible to three-phase, No Internal Circuit Protection	3600, 4800, 6000
EHK10AKN	10 kW, Single-Phase, No Internal Circuit Protection	ALL
EHK10AKB	10 kW, Single-Phase with Circuit Breakers	ALL
EHK15AKF	15 kW, Single-phase with Fuses	ALL
EHK15AKB	15 kW, Single-Phase with Circuit Breakers	ALL
EHK15AHN	15 kW, Three-Phase, No Internal Circuit Protection	ALL
EHK18AHN	18 kW, Three-phase, No Internal Circuit Protection	4800, 6000
EHK20AKF	20 kW, Single-Phase with Fuses	ALL
EHK20AKB	20 kW, Single-Phase with Circuit Breakers	ALL
EHK25AHCF	24 kW, Supplied as Three-Phase, Field Convertible to Single-Phase with Fuses	4800, 6000
EHK30AHCF	30 kW, Supplied as Three-Phase, Field Convertible to Single-Phase with Fuses	4800, 6000
EHK Electric Heaters for FVM, FXM4X, FEM, FSM		
EHK05AKN	5 kW, Single-Phase, No Internal Circuit Protection	ALL
EHK05AKB	5 kW, Single-Phase with Circuit Breakers	ALL
EHK07AKN	8 kW, Single-Phase, No Internal Circuit Protection	ALL
EHK07AKB	8 kW, Single-Phase with Circuit Breakers	ALL
EHK09AKCN	9 kW, Supplied as Single-Phase, Field Convertible to Three-Phase, No Internal Circuit Protection	3600B, 4200B, 4800B, 6000B
EHK10AKN	10 kW, Single-Phase, No Internal Circuit Protection	ALL
EHK10AKB	10 kW, Single-Phase with Circuit Breakers	ALL
EHK14AKF	15 kW, Single-Phase with Fuses	2400C, 3000B, 3600B, 4200B, 4800B, 6000B
EHK15AKB	15 kW, Single-Phase with Circuit Breakers	2400C, 3000B, 3600B, 4200B, 4800B, 6000B
EHK15AHN	15 kW, Three-Phase, No Internal Circuit Protection	3600, 4200, 4800, 6000
EHK18AHN	18 kW, Three-Phase, No Internal Circuit Protection	4200, 4800, 6000
EHK20AKF	20 kW, Single-Phase with Fuses	3000, 3600, 4200, 4800, 6000
EHK20AKB	20 kW, Single-Phase with Circuit Breakers	3000, 3600, 4200, 4800, 6000

Accessories

Fan Coil (TXV)

EHK Electric Heaters for FVM, FXM4X, FEM		
Part Number	Description	Use with
EHK25AHCF	24 kW, Supplied as Three-Phase, Field Convertible to Single-Phase with Fuses	4800B, 6000B
EHK30AHCF	30 kW, Supplied as Three-Phase, Field Convertible to Single-phase with Fuses	4800B, 6000B
MV and MF		
AMF016DFB1	Downflow Kit	16
Electric Heaters for MV and MF Series		
EHIA00KN10	No Heat Kit	08, 12, 16, 20
EHIA05KB10	5 kW, Single-Phase with C.B.	08, 12, 16, 20
EHIA05KN10	5 kW, Single-Phase with T.B.	08, 12, 16, 20
EHIA07KB10	7.5 kW, Single-Phase with C.B.	08, 12, 16, 20
EHIA07KN10	7.5 kW, Single-Phase with T.B.	08, 12, 16, 20
EHIA10KB10	10 kW, Single-Phase with C.B.	08, 12, 16, 20
EHIA10KN10	10 kW, Single-Phase with T.B.	08, 12, 16, 20
EHIA15KB10	15 kW, Single-Phase with C.B.	08, 12, 16, 20
EHIA20KB10	20 kW, Single-Phase with C.B.	12, 16, 20
EHIA25KB10	25 kW, Single-Phase with C.B.	16, 20
EHIA10HB10	10 kW, Three-Phase with C.B.	12, 16, 20
EHIA15HB10	15 kW, Three-Phase with C.B.	12, 16, 20
EHIA20HB10	20 kW, Three-Phase with C.B.	16, 20
EHIA25HB10	25 kW, Three-Phase with C.B.	16, 20
Accessories for FMA4X		
EHK205B	5 kW, Single-Phase	ALL
EHK208B	7.5 kW, Single-Phase	ALL
EHK210B	10 kW, Single-Phase	ALL
AMWK001WG	Louvered Wall Panel with Frame (6 pack)	18, 24
AMWK002WG	Louvered Wall Panel with Frame (6 pack)	30, 36
NAEA20101TX	TXV Kit, R-22	18, 24, 30, 36
NAEA40501TX	TXV Kit, R-410A	18, 24, 30
NAEA40601TX	TXV Kit, R-410A	36
Accessories for FMU4X and FMC4X		
EHK305B	5 kW, Single-Phase	ALL
EHK308B	7.5 kW, Single-Phase	ALL
EHK310B	10 kW, Single-Phase	ALL
NASA00101GF	Louvered Wall Panel with Filter Rack – Small	18, 24
NASA00201GF	Louvered Wall Panel with Filter Rack – Large	30, 36
NASA00101CC	Access Panel – Small	18, 24
NASA00201CC	Access Panel – Large	30, 36
NAEA20101TX	TXV Kit, R-22	18, 24, 30, 36
NAEA40501TX	TXV Kit, R410A	18, 24, 30
NAEA40601TX	TXV Kit, R410A	36

EAM4X

Multi-Position Evaporator Coils Cased A-Coils

1-1/2 – 5 Tons



Features

- Bolt-on R-410A TXV metering device factory installed on all models (equalizer tube brazed in)
- TXV and manifold positioned to the side for easier cleaning
- Innovative drain pan design for complete water removal
- Two condensate drain connections (additional two for horizontal installation)
- Two-piece delta plate for easier removal and cleaning
- Cabinet widths match flush with ICP gas furnaces
- Hemmed flanges for safer handling
- Foil faced insulation
- Non-sweat cabinet, even at extreme conditions
- Cabinets meet or exceed 2% air leakage codes
- Sturdy, 22-gauge, pre-painted steel cabinet
- Multi-position installation - upflow, downflow, or horizontal
- One or two UV light knock-outs provided on cabinet (depending on size)
- Aluminum main tubing and aluminum fins (copper stubs for field connection)

Warranty*

- Five-year parts limited warranty
 - With timely registration, an additional five-year parts limited warranty

* For residential applications only. See warranty certificate for complete details and restrictions, including warranty coverage for other applications.

Unit Performance Data

Model Number	Size (tons)	Operating Dimensions H x W x D (sq) in (mm)
EAMA4X18L14A	1-1/2	25-13/16 x 14-3/16 x 20-5/8 (659 x 361 x 524)
EAMA4X19L17A	1-1/2	25-13/16 x 17-1/2 x 20-5/8 (659 x 445 x 524)
EAMA4X24L14A	2	25-13/16 x 14-3/16 x 20-5/8 (659 x 361 x 524)
EAMA4X24L17A	2	25-13/16 x 17-1/2 x 20-5/8 (659 x 445 x 524)
EAMA4X25L17A	2	29-3/4 x 17-1/2 x 20-5/8 (757 x 445 x 524)
EAMA4X30L14A	2-1/2	25-13/16 x 14-3/16 x 20-5/8 (659 x 361 x 524)
EAMA4X30L17A	2-1/2	25-13/16 x 17-1/2 x 20-5/8 (659 x 445 x 524)
EAMA4X36L17A	3	25-13/16 x 17-1/2 x 20-5/8 (659 x 445 x 524)
EAMA4X36L21A	3	29-3/4 x 21 x 20-5/8 (757 x 533 x 524)
EAMA4X37L17A	3	25-13/16 x 17-1/2 x 20-5/8 (659 x 445 x 524)
EAMA4X37L21A	3	29-3/4 x 21 x 20-5/8 (757 x 533 x 524)
EAMA4X42L21A	3-1/2	29-3/4 x 21 x 20-5/8 (757 x 533 x 524)
EAMA4X42L24A	3-1/2	29-3/4 x 24-1/2 x 20-5/8 (757 x 622 x 524)
EAMA4X43L21A	3-1/2	29-3/4 x 21 x 20-5/8 (757 x 533 x 524)
EAMA4X48L21A	4	29-3/4 x 21 x 20-5/8 (757 x 533 x 524)
EAMA4X48L24A	4	29-3/4 x 21 x 20-5/8 (757 x 533 x 524)
EAMA4X60L21A	5	35 x 21 x 20-5/8 (889 x 533 x 524)
EAMA4X60L24A	5	35 x 24-1/2 x 20-5/8 (889 x 622 x 524)
EAMA4X61L24A	5	35 x 24-1/2 x 20-5/8 (889 x 622 x 524)



EAD4X

Upflow or Downflow Evaporator Coils Cased A-Coils

1-1/2 – 5 Tons

Features

- Bolt-on R-410A TXV metering device factory installed on all models (equalizer tube brazed in)
- TXV and manifold positioned to the side for easier cleaning
- Innovative drain pan design for complete water removal
- Two condensate drain connections (additional two for horizontal installation)
- Two-piece delta plate for easier removal and cleaning
- Cabinet widths match flush with ICP gas furnaces
- Hemmed flanges for safer handling
- Foil faced insulation
- Non-sweat cabinet, even at extreme conditions
- Cabinets meet or exceed 2% air leakage codes
- Sturdy, 22-gauge, pre-painted steel cabinet
- Vertical installation – upflow or downflow
- One or two UV light knock-outs provided on cabinet (depending on size)
- Aluminum main tubing and aluminum fins (copper stubs for field connection)

Warranty*

- Five-year parts limited warranty
 - With timely registration, an additional five-year parts limited warranty

* For residential applications only. See warranty certificate for complete details and restrictions, including warranty coverage for other applications.

Unit Performance Data

Model Number	Size (tons)	Operating Dimensions H x W x D (sq) in (mm)
EAD4X19L17A	1-1/2	25-13/16 x 17-1/2 x 20-5/8 (659 x 445 x 524)
EAD4X25L17A	2	29-3/4 x 17-1/2 x 20-5/8 (757 x 445 x 524)
EAD4X37L17A	3	25-13/16 x 17-1/2 x 20-5/8 (659 x 445 x 524)
EAD4X37L21A	3	29-3/4 x 21 x 20-5/8 (757 x 533 x 524)
EAD4X43L21A	3-1/2	29-3/4 x 21 x 20-5/8 (757 x 533 x 524)
EAD4X61L24A	5	35 x 24-1/2 x 20-5/8 (889 x 622 x 524)

EAA4X

Upflow and Downflow Evaporator Coils Uncased A-Coils

1-1/2 – 5 Tons



Features

- Bolt-on R-410A TXV metering device factory installed on all models (equalizer tube brazed in)
- TXV and manifold positioned to the side for easier cleaning
- Innovative drain pan design for complete water removal
- Two-piece delta plate for easier removal and cleaning
- Hemmed flanges for safer handling
- Vertical installation – upflow or downflow
- Aluminum main tubing and aluminum fins (copper stubs for field connection)

Warranty*

- Five-year parts limited warranty
 - With timely registration, an additional five-year parts limited warranty

* For residential applications only.
See warranty certificate for complete details and restrictions, including warranty coverage for other applications.

Unit Performance Data

Model Number	Size (tons)	Operating Dimensions H x W x D (sq) in. (mm)
EAA4X18L14A	1-1/2	13-5/8 x 13 x 20-1/8 (346 x 330 x 511)
EAA4X24L14A	2	17-3/4 x 13 x 20-1/8 (451 x 330 x 511)
EAA4X24L17A	2	21-7/8 x 13 x 20-1/8 (556 x 330 x 511)
EAA4X30L14A	2-1/2	17-1/4 x 16-5/16 x 20-1/8 (451 x 414 x 511)
EAA4X30L17A	2-1/2	21-7/8 x 16-5/16 x 20-1/8 (545 x 414 x 511)
EAA4X36L17A	3	23-9/16 x 16-5/16 x 20-1/8 (598 x 414 x 511)
EAA4X36L21A	3	23 x 19-13/16 x 20-1/8 (584 x 503 x 511)
EAA4X42L21A	3-1/2	25-1/16 x 19-13/16 x 20-1/8 (637 x 503 x 511)
EAA4X48L21A	4	25-5/16 x 19-13/16 x 20-1/8 (643 x 503 x 511)
EAA4X48L24A	4	24-13/16 x 23-5/16 x 20-1/8 (630 x 592 x 511)
EAA4X60L24A	5	31-1/16 x 23-5/16 x 20-1/8 (789 x 592 x 511)



END4X

Vertical Evaporator Coils Cased N-Coils

1-1/2 – 5 Tons
Environmentally Sound R-410A Systems

Features

- Bolt-on TXV metering device factory installed on all models (equalizer tube brazed in)
- Two condensate drain connections
- Cabinet widths match flush with ICP 14-3/16", 17-1/2", 21" and 24-1/2" gas furnace cabinets (field fabricated transitions required to match other ICP furnace models)
- Removable front access panel
- Hemmed flanges for safer handling
- Foil faced insulation
- Non-sweat cabinet, even at extreme conditions
- Cabinets meet or exceed 2% air leakage codes
- Sturdy, pre-painted steel cabinet
- Upflow or downflow installation (cased use only)
- Compact design
- Aluminum main tubing and aluminum fins (copper stubs for field connection)

Warranty*

- Five-year parts limited warranty
 - With timely registration, an additional five-year parts limited warranty

* For residential applications only.
See warranty certificate for complete details and restrictions, including warranty coverage for other applications.

Unit Performance Data

Model Number	Size (tons)	Operating Dimensions H x W x D (sq) in. (mm)
END4X18L14A	1-1/2	12-5/8 x 14-3/16 x 21 (321 x 360 x 533)
END4X19L17A	1-1/2	17 x 17-1/2 x 21 (432 x 445 x 533)
END4X24L14A	2	14-5/8 x 14-3/16 x 21 (372 x 360 x 533)
END4X24L17A	2	14-5/8 x 17-1/2 x 21 (372 x 445 x 533)
END4X30L14A	2-1/2	17 x 14-3/16 x 21 (432 x 360 x 533)
END4X30L17A	2-1/2	17 x 17-1/2 x 21 (432 x 445 x 533)
END4X31L17A	2-1/2	23-1/4 x 17-1/2 x 21 (591 x 445 x 533)
END4X36L17A	3	17 x 17-1/2 x 21 (432 x 445 x 533)
END4X36L21A	3	17 x 21 x 21 (432 x 533x 533)
END4X37L17A	3	27-3/16 x 17-1/2 x 21 (691 x 445 x 533)
END4X42L17A	3-1/2	21-1/8 x 17-1/2 x 21 (537 x 445 x 533)
END4X42L21A	3-1/2	19 x 21 x 21 (483 x 533 x 533)
END4X43L24A	3-1/2	26-5/16 x 24-1/2 x 21 (669 x 622 x 533)
END4X48L21A	4	22-1/16 x 21 x 21 (560 x 533 x 533)
END4X48L24A	4	22-1/16 x 24-1/2 x 21 (560 x 622 x 533)
END4X60L24A	5	26-7/8 x 24-1/2 x 21 (683 x 622 x 533)
END4X61L24A	5	32-7/16 x 24-1/2 x 21 (824 x 622 x 533)

ENW4X

Vertical Evaporator Coils Cased N-Coils

3 – 5 Tons
Environmentally Sound R-410A Systems



Features

- Drain pan raised 2" (51 mm) and block-off plate factory installed – for installing wider coil on narrower furnace
- Bolt-on TXV metering device factory installed on all models (equalizer tube brazed in)
- Two condensate drain connections
- Removable front access panel
- Hemmed flanges for safer handling
- Foil faced insulation
- Non-sweat cabinet, even at extreme conditions
- Cabinets meet or exceed 2% air leakage codes
- Sturdy, pre-painted steel cabinet
- Upflow or downflow installation (cased use only)
- Aluminum main tubing and aluminum fins (copper stubs for field connection)

Warranty*

- Five-year parts limited warranty
 - With timely registration, an additional five-year parts limited warranty

* For residential applications only.
See warranty certificate for complete details and restrictions, including warranty coverage for other applications.

Unit Performance Data

Model Number	Size (tons)	Operating Dimensions H x W x D (sq) in. (mm)
ENW4X36L17A	3	19-13/16 x 17-1/2 x 21 (503 x 445 x 533)
ENW4X42L21A	3-1/2	21-13/16 x 21 x 21 (432 x 533 x 533)
ENW4X48L21A	4	24-7/8 x 21 x 21 (632 x 533 x 533)
ENW4X60L24A	5	29-1/8 x 24-1/2 x 21 (740 x 622 x 533)



ENH4X

Horizontal Evaporator Coils Cased N-Coils

2 – 5 Tons
Environmentally Sound R-410A Systems

Features

- Bolt-on TXV metering device factory installed on all models (equalizer tube brazed in)
- Two condensate drain connections
- Cabinet widths match flush with ICP 17-1/2", 21" and 24-1/2" gas furnace cabinets (field fabricated transitions required to match other ICP furnace models)
- Removable front access panel
- Hemmed flanges for safer handling
- Foil faced insulation
- Non-sweat cabinet, even at extreme conditions
- Cabinets meet or exceed 2% air leakage codes
- Sturdy, pre-painted steel cabinet
- Horizontal installation
- Aluminum main tubing and aluminum fins (copper stubs for field connection)

Warranty*

- Five-year parts limited warranty
 - With timely registration, an additional five-year parts limited warranty

* For residential applications only. See warranty certificate for complete details and restrictions, including warranty coverage for other applications.

Unit Performance Data

Model Number	Size (tons)	Operating Dimensions H x W x D (sq) in. (mm)
ENH4X24L17A	2	19 x 17-1/2 x 20-3/4 (483 x 445 x 527)
ENH4X30L17A	2-1/2	22-1/16 x 17-1/2 x 20-3/4 (560 x 445 x 527)
ENH4X31L17A	2-1/2	27-1/2 x 17-1/2 x 20-3/4 (699 x 445 x 527)
ENH4X36L17A	3	22-1/16 x 17-1/2 x 20-3/4 (560 x 445 x 527)
ENH4X42L21A	3-1/2	22-1/16 x 21 x 20-3/4 (560 x 533 x 527)
ENH4X43L21A	3-1/2	30-1/8 x 21 x 20-3/4 (766 x 533 x 527)
ENH4X48L21A	4	28-1/16 x 21 x 20-3/4 (713 x 533 x 527)
ENH4X60L24A	5	29 x 24-1/2 x 20-3/4 (737 x 622 x 527)
ENH4X61L24A	5	29-1/16 x 24-1/2 x 20-3/4 (737 x 622 x 527)

EDM4X

Cased Multi-Position A-Coils



1-1/2 – 5 Tons

Environmentally Sound R-410A Systems

Widths Match 15-1/2, 19-1/4, 22-3/4, 24-1/2 ICP Gas Furnaces

Features

- Removable front access panel
- Easy slide-out coil for inspection
- Two UV light knock-outs provided on cabinet
- Hemmed flanges for safer handling
- Foil faced insulation
- Non-sweat cabinet, even at extreme conditions
- Cabinets meet or exceed 2% air leakage codes
- Multi-position installation – upflow, downflow or horizontal
- Sturdy, 22-gauge, pre-painted steel cabinet
- Upflow or downflow installation (cased use only)
- Aluminum main tubing and aluminum fins (copper stubs for field connection)

Coil Features

- Bolt-on TXV metering device factory installed on all models (equalizer tube brazed in)
- TXV and manifold positioned to the side for easier cleaning
- Innovative drain pan design for complete water removal
- Two condensate drain connections
- Two-piece delta plate for easier removal and cleaning

Warranty*

- Five-year parts limited warranty
 - With timely registration, an additional five-year parts limited warranty

* For residential applications only.

See warranty certificate for complete details and restrictions, including warranty coverage for other applications.

Unit Performance Data

Model Number	Size (tons)	Operating Dimensions H x W x D (sq) in. (mm)
EDM4X18BAL	1-1/2	25-7/8 x 15-5/8 x 20-5/8 (657 x 397 x 524)
EDM4X24BAL	2	25-7/8 x 15-5/8 x 20-5/8 (657 x 397 x 524)
EDM4X24FAL	2	25-7/8 x 19-1/4 x 20-5/8 (657 x 489 x 524)
EDM4X30BAL	2-1/2	25-7/8 x 15-5/8 x 20-5/8 (657 x 397 x 524)
EDM4X30FAL	2-1/2	25-7/8 x 19-1/4 x 20-5/8 (657 x 489 x 524)
EDM4X36BAL	3	29-3/4 x 15-5/8 x 20-5/8 (756 x 397 x 524)
EDM4X36FAL	3	29-3/4 x 19-1/4 x 20-5/8 (756 x 489 x 524)
EDM4X36JAL	3	29-3/4 x 22-7/8 x 20-5/8 (756 x 581 x 524)
EDM4X42FAL	3-1/2	29-3/4 x 19-1/4 x 20-5/8 (756 x 489 x 524)
EDM4X42JAL	3-1/2	29-3/4 x 19-1/4 x 20-5/8 (756 x 489 x 524)
EDM4X42LAL	3-1/2	29-3/4 x 22-7/8 x 20-5/8 (756 x 581 x 524)
EDM4X48FAL	4	35 x 19-1/4 x 20-5/8 (889 x 489 x 524)
EDM4X48JAL	4	29-3/4 x 22-7/8 x 20-5/8 (756 x 581 x 524)
EDM4X48LAL	4	29-3/4 x 24-1/2 x 20-5/8 (756 x 622 x 524)
EDM4X60JAL	5	35 x 22-7/8 x 20-5/8 (889 x 581 x 524)
EDM4X60LAL	5	35 x 24-1/2 x 20-5/8 (881 x 622 x 524)

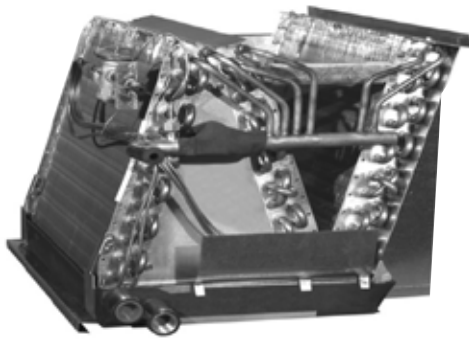

ENA4X

Vertical Evaporator Coils Uncased N-Coils

1-1/2 – 5 Tons
Environmentally Sound R-410A Systems

Features

- Bolt-on TXV metering device factory installed on all models (equalizer tube brazed in)
- Two condensate drain connections
- Upflow or downflow installation (plenum use only)
- Aluminum main tubing and aluminum fins (copper stubs for field connection)

Warranty*

- Five-year parts limited warranty
 - With timely registration, an additional five-year parts limited warranty

* For residential applications only.
See warranty certificate for complete details and restrictions, including warranty coverage for other applications.

Unit Performance Data

Model Number	Size (tons)	Operating Dimensions H x W x D (sq) in. (mm)
ENA4X18L14A	1-1/2	10-7/8 x 12-7/8 x 19-3/8 (276 x 327 x 492)
ENA4X19L17A	1-1/2	14-11/16 x 16-1/4 x 19-3/8 (373 x 413 x 492)
ENA4X24L14A	2	12-7/8 x 12-7/8 x 19-3/8 (327 x 327 x 492)
ENA4X24L17A	2	12-11/16 x 16-1/4 x 19-3/8 (322 x 413 x 492)
ENA4X30L14A	2-1/2	14-7/8 x 12-7/8 x 19-3/8 (378 x 327 x 492)
ENA4X30L17A	2-1/2	14-11/16 x 16-1/4 x 19-3/8 (373 x 413 x 492)
ENA4X31L17A	2-1/2	20-3/4 x 16-1/4 x 19-3/8 (527 x 413 x 492)
ENA4X36L17A	3	14-11/16 x 16-1/4 x 19-3/8 (373 x 413 x 492)
ENA4X36L21A	3	14-7/16 x 19-5/8 x 19-3/8 (367 x 499 x 492)
ENA4X37L17A	3	24-3/4 x 16-1/4 x 19-3/8 (629 x 413 x 492)
ENA4X42L21A	3-1/2	16-1/2 x 19-5/8 x 19-3/8 (419 x 499 x 492)
ENA4X43L24A	3-1/2	24-3/8 x 23-1/8 x 19-3/8 (619 x 587 x 492)
ENA4X48L21A	4	20-9/16 x 19-5/8 x 19-3/8 (522 x 499 x 492)
ENA4X48L24A	4	20-5/16 x 23-1/8 x 19-3/8 (516 x 587 x 492)
ENA4X60L24A	5	24-3/8 x 23-1/8 x 19-3/8 (619 x 587 x 492)
ENA4X61L24A	5	30-1/2 x 23-1/8 x 19-3/8 (774 x 587 x 492)

EMA4X

Coils for Manufactured Housing

2, 3 and 4 Tons Environmentally Sound R-410A Systems

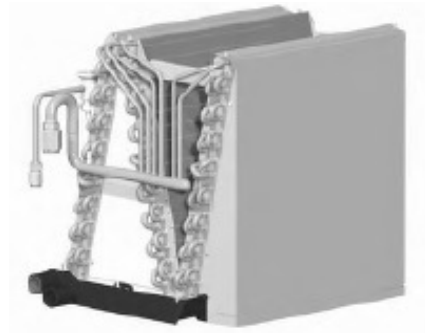

Features

- Designed for mobile home downflow gas furnaces
- Bolt-on TXV metering device factory installed on all models (equalizer tube brazed in)
- Two condensate drain connections
- “N” evaporator design to keep height at a minimum
- Shipped with condensate drain hose and trap
- Shipped with fittings and adapter plates
- Aluminum main tubing and aluminum fins (copper stubs for field connection)

Warranty*

- Five-year parts limited warranty
 - With timely registration, an additional five-year parts limited warranty

* For residential applications only.
See warranty certificate for complete details and restrictions, including warranty coverage for other applications.

Unit Performance Data

Model Number	Size (tons)	Operating Dimensions H x W x D (sq) in. (mm)
EMA4X24DAL	2	12-5/8 x 17-7/8 x 19-9/16 (321 x 454 x 497)
EMA4X36DAL	3	14-11/16 x 17-7/8 x 19-9/16 (373 x 454 x 497)
EMA4X48DAL	4	18-3/4 x 17-7/8 x 19-9/16 (476 x 454 x 497)



EHD4X

Cased Horizontal Duct Coils

2 – 5 Tons
Environmentally Sound R-410A Systems

Features

- Horizontal, bi-directional airflow
- Bolt-on TXV metering device factory installed on all models (equalizer tube brazed in)
- Slide-out feature for easy cleaning
- Pre-painted steel cabinet
- Aluminum main tubing and aluminum fins (copper stubs for field connection)

Warranty*

- Five-year parts limited warranty
 - With timely registration, an additional five-year parts limited warranty

* For residential applications only.
See warranty certificate for complete details and restrictions, including warranty coverage for other applications.

Unit Performance Data

Model Number	Size (tons)	Operating Dimensions H x W x D (sq) in. (mm)
EHD4X24AAL	2	28-3/8 x 11-3/4 x 24-1/16 (721 x 298 x 637)
EHD4X30AAL	2-1/2	28-3/8 x 11-3/4 x 24-1/16 (721 x 298 x 637)
EHD4X36AAL	3	28-3/8 x 11-3/4 x 28-13/16 (721 x 298 x 732)
EHD4X42AAL	3-1/2	28-3/8 x 11-3/4 x 28-13/16 (721 x 298 x 732)
EHD4X48AAL	4	30-3/8 x 11-3/4 x 28-13/16 (772 x 298 x 732)
EHD4X60AAL	5	30-3/8 x 11-3/4 x 38-15/16 (772 x 298 x 989)

MB

Modular Blower Cabinet



2, 3 and 4 Tons

Features

- Air conditioning ready
- Heat pump ready (no electric heat)
- Upflow, downflow, horizontal right or left applications
- Three speed PSC motor on all models
- Thermosetting powder coated steel cabinet
- 115V-1-60 supply voltage
- Matches with AC and HP cased coils

Service

- Direct drive slide-out blower assembly

Quality

- Internally lined with 1/2" (12.7 mm) insulation

Warranty*

- Five-year parts limited warranty

* For residential applications only.
See warranty certificate for complete details and restrictions,
including warranty coverage for other applications.

Unit Performance Data

Model Number	Nominal Tons	Nominal CFM	Motor HP	Operating Dimensions H x W x D (sq) in. (mm)	Unit Wt. lbs (kg)	Ship Wt. lbs (kg)
MB080014C	2	800	1/3	24 x 14-1/2 x 20-1/2 (610 x 360 x 521)	54 (25)	58 (26)
MB120017C	3	1200	1/2	24 x 17-1/2 x 20-1/2 (610 x 445 x 521)	58 (26)	62 (28)
MB160021C	4	1600	1/2	25 x 21 x 20-1/2 (635 x 533 x 521)	70 (32)	75 (34)
MB200024C	5	2000	3/4	25 x 24-1/2 x 20-1/2 (635 x 622 x 521)	73 (33)	79 (36)



MF

Modular Electric Furnace

2, 3, 4 and 5 Tons

Features

- Modular blower cabinet, air conditioning or heat pump ready
- Upflow, horizontal right or left applications
- Downflow requires sub-base accessory
- Electronic fan control board
- Three speed PSC motor on all models
- Matches with AC and HP cased coils (hot water coil may be used, but doesn't match case size)
- Accepts accessory two-stage outdoor thermostats
- 208/230-1-60 supply voltage
- Requires a "NO HEAT KIT" if installed without electric heat
- Field installed electric heater packages from 5kW-25kW, single- or three-phase available separately

Service

- Direct drive slide-out blower assembly

Quality

- Internally lined with 1/2" (12.7 mm) insulation
- Thermosetting powder coated steel cabinet

Warranty*

- Five-year parts limited warranty

* For residential applications only.

See warranty certificate for complete details and restrictions, including warranty coverage for other applications.

Unit Performance Data

Model Number	Nominal Tons	Nominal CFM	Motor HP	Operating Dimensions H x W x D (sq) in. (mm)	Unit Wt. lbs (kg)	Ship Wt. lbs (kg)
MF080014C	2	800	1/3	24 x 14-1/2 x 20-1/2 (610 x 360 x 521)	54 (25)	58 (26)
MF120017C	3	1200	1/2	24 x 17-1/2 x 20-1/2 (610 x 445 x 521)	58 (26)	62 (28)
MF160021C	4	1600	1/2	25 x 21 x 20-1/2 (635 x 533 x 521)	70 (32)	75 (34)
MF200024C	5	2000	3/4	25 x 24-1/2 x 20-1/2 (635 x 622 x 521)	73 (33)	79 (36)

MV

Modular Variable-Speed Blower Cabinet

2, 3, 4 and 5 Tons



Features

- Variable-speed modular blower
- Supports two-stage outdoor units
- Dehumidification speed: 80% airflow
- Efficient low continuous fan selection: 50% airflow
- Upflow, horizontal right or left applications
- Downflow requires sub-base accessory
- Electronic fan control board
- Adjustable blower time delay
- Accepts accessory two-stage outdoor thermostats
- Matches with AC and HP cased coils
- 208/230-1-60 supply voltage
- Requires a "NO HEAT KIT" if installed without electric heat
- Field installed electric heater packages from 5kW-25kW, single- or three-phase available separately

Service

- Direct drive slide-out blower assembly

Quality

- Internally lined with 1/2" (12.7 mm) insulation
- Thermosetting powder coated steel cabinet

Warranty*

- Five-year parts limited warranty

* For residential applications only.
See warranty certificate for complete details and restrictions, including warranty coverage for other applications.

Unit Performance Data

Model Number	Nominal Tons	Nominal CFM	Motor HP	Operating Dimensions H x W x D (sq) in. (mm)	Unit Wt. lbs (kg)	Ship Wt. lbs (kg)
MV080014C	2	800	1/2	24 x 14-1/2 x 20-1/2 (610 x 360 x 521)	54 (25)	58 (26)
MV120017C	3	1200	1/2	24 x 17-1/2 x 20-1/2 (610 x 445 x 521)	58 (26)	62 (28)
MV0160021C	4	1600	3/4	25 x 21 x 20-1/2 (635 x 533 x 521)	70 (32)	75 (34)
MV200024C	5	2000	3/4	25 x 24-1/2 x 20-1/2 (635 x 622 x 521)	73 (33)	79 (36)

Ductless Systems



DLCDAR, DLCDHR, DLFDA B, DLFDHB

Outdoor Cooling Only, Outdoor Heat Pump,
Indoor Cooling Only, Indoor Heat Pump
High Wall Ductless Split System
Sizes 09-36



High Wall Standard Features

- Variable-speed (Inverter)
- Modes: Cool, Heat, Dry, Fan, Auto
- Auto louver mode
- X-Fan mode
- Dehumidifying mode
- Four fan speeds
- Sleep mode
- Quiet operation
- 46° F heating mode (heating setback)
- I FEEL function

Control Features

- Wireless remote control (standard)
- Wired remote control (optional)

Unit Performance Data

Cooling Only – Variable-Speed System

System Tons	System Btuh	Volt-PH @ 60Hz	SEER	EER	Indoor Model Number	Outdoor Model Number
0.75	9,000	115-1	16.0	9.6	DLFDAB09J1A	DLCDAR09J1A
1	12,000	115-1	16.0	10.6	DLFDAB12J1A	DLCDAR12J1A
0.75	9,000	208/230-1	16.0	10.0	DLFDAB09K1A	DLCDAR09K1A
1	12,000	208/230-1	16.0	9.3	DLFDAB12K1A	DLCDAR12K1A
1.5	18,000	208/230-1	16.0	10.0	DLFDAB18K1A	DLCDAR18K1A
1.83	22,000	208/230-1	16.0	9.8	DLFDAB24K1A	DLCDAR24K1A

Heating Only with Factory Installed Base Pan Heater – Variable-Speed System

System Tons	System Btuh	Volt-PH @ 60Hz	SEER	EER	HSPF	Indoor Model Number	Outdoor Model Number
0.75	9,000	115-1	16.0	9.6	9.0	DLFDHB09J1A	DLCDHR09J1A
1	12,000	115-1	16.0	10.6	9.0	DLFDHB12J1A	DLCDHR12J1A
0.75	9,000	208/230-1	16.0	10.0	9.0	DLFDHB09K1A	DLCDHR09K1A
1	12,000	208/230-1	16.0	9.3	9.0	DLFDHB12K1A	DLCDHR12K1A
1.5	18,000	208/230-1	16.0	9.0	9.0	DLFDHB18K1A	DLCDHR18K1A
1.83	22,000	208/230-1	16.0	9.8	9.0	DLFDHB24K1A	DLCDHR24K1A
2.33	28,000	208/230-1	18.0	10.4	8.2	DLFDHB30K1A	DLCDHR30K1A
2.8	33,600	208/230-1	18.0	8.6	8.2	DLFDHB36K1A	DLCDHR36K1A

Accessories

Ordering Number	Description	For Models
KSACN0201AAA	Wired Remote Control	All Systems



DLCAHB-Outdoor, DLFAHH-Indoor

High Wall Ductless Split System

Sizes 09-18

High Wall Standard Features

- Variable-speed (Inverter), two-stage compressor
- Modes: Cool, Heat, Dry, Fan, Auto
- 80% heating capacity at -22° F
- Auto louver mode
- 180° vertical air supply
- X-Fan mode
- Dehumidifying mode
- Seven fan speeds
- Sleep mode
- Quiet operation
- 46° F heating mode (heating setback)
- I FEEL function

Control Features

- Wireless remote control (standard)

Unit Performance Data

Heat Pump with Factory Installed Base Pan Heater – Variable-Speed System

System Tons	System Btuh	Volt-PH @ 60Hz	SEER	EER	HSPF	Indoor Model Number	Outdoor Model Number
0.75	9,000	208/230-1	30.5	15.8	10.3	DLFAHH09K1A	DLCAHB09K1A
1	12,000	208/230-1	23.0	12.8	10.3	DLFAHH12K1A	DLCAHB12K1A
1.5	18,000	208/230-1	21.0	12.5	10.3	DLFAHH18K1A	DLCAHB18K1A

Wireless remote control included with indoor unit. Wired remote control not available.

DLCBHR-Outdoor DLFAAH, DLFDHB, DLFBHC, DLFBHD, DLFBHF

Multi-Zone Ductless Split System

Sizes 18-56

High Wall Standard Features

- Variable-speed (Inverter)
- Built-in base pan heater
- Quiet operation
- Connect up to nine multiple style indoor units
 - High wall (DLFAHH and DLFBHB)
 - Cassette (DLFBHC)
 - Ducted (DLFBHD)
 - Floor Console (DLFBHF)



DLFBHB



DLFAHH



DLFBHD



DLFBHC



DLFBHF



Control Features

- Wireless remote controller included with each indoor unit
- Wired remote controller included with ducted and cassette indoor unit (optional DLFBHB high wall)



Branch Box



18k / 24k / 30k



36k / 42k



18k / 24k / 30k

Unit Performance Data

Outdoor Unit – Heat Pump with Factory Installed Base Pan Heater – Variable-Speed System

System Tons	System Btuh	Volt-PH @ 60Hz	Min # of Indoor Units	Max # of Indoor Units	SEER	EER	HSPF	Outdoor Model Number
1.5	18,000	208/230-1	2	2	22.0	10.9	9.0	DLCBHR18K1A
2	24,000	208/230-1	2	3	20.5	10.2	11.0	DLCBHR24K1A
2.5	30,000	208/230-1	2	4	21.0	12.0	10.2	DLCBHR30K1A
3	36,000	208/230-1	2	4	21.0	12.1	10.2	DLCBHR36K1A
3.5	42,000	208/230-1	2	5	21.0	10.4	10.2	DLCBHR42K1A
4	48,000	208/230-1	2	8	16.0	9.5	8.2	DLCBHR48K1A
4.67	56,000	208/230-1	2	9	16.0	9.4	8.2	DLCBHR56K1A

Note: All ports do not need to be used at time of the original installation. Future system expansion is possible.
Branch Box is required on sizes 48 and 56; sold separately.

High Wall DLFAHH Indoor Unit

Unit Tons	Unit Btuh	Volt-PH @ 60Hz	Indoor Model Number
0.75	9,000	208/230-1	DLFAHH09K1A
1	12,000	208/230-1	DLFAHH12K1A
1.5	18,000	208/230-1	DLFAHH18K1A

Note: Wireless remote controller included with each indoor unit. Wired remote control not available.

DLCBHR-Outdoor DLFAAH, DLFDHB, DLFBHC, DLFBHD, DLFBHF con't Multi-Zone Ductless Split System

Sizes 18-56

Unit Performance Data

High Wall DLFBHB Indoor Unit

Unit Tons	Unit Btuh	Volt-PH @ 60Hz	Indoor Model Number
0.75	9,000	208/230-1	DLFBHB09K1A
1	12,000	208/230-1	DLFBHB12K1A
1.5	18,000	208/230-1	DLFBHB18K1A
2	24,000	208/230-1	DLFBHB24K1A

Note: Wireless remote controller included with each indoor unit. Wired remote control not available.

Cassette Indoor Unit

Unit Tons	Unit Btuh	Volt-PH @ 60Hz	Indoor Model Number	Grille Model Number
1	12,000	208/230-1	DLFBHC12K1A	DLFBHC01K1A
1.5	18,000	208/230-1	DLFBHC18K1A	DLFBHC01K1A
2	24,000	208/230-1	DLFBHC24K1A	DLFBHC02K1A

Note: Wireless and wired remote controller included with each indoor unit. Condensate pump factory installed on indoor unit.
Grille is required; sold separately.

Ducted Indoor Unit

Unit Tons	Unit Btuh	Volt-PH @ 60Hz	Indoor Model Number
0.75	9,000	208/230-1	DLFBHD09K1A
1	12,000	208/230-1	DLFBHD12K1A
1.5	18,000	208/230-1	DLFBHD18K1A
1.75	21,000	208/230-1	DLFBHD21K1A
2	24,000	208/230-1	DLFBHD24K1A

Note: Wireless and wired remote controller included with each indoor unit.
Condensate pump factory installed on indoor unit.

Floor Console Indoor Unit

Unit Tons	Unit Btuh	Volt-PH @ 60Hz	Indoor Model Number
0.75	9,000	208/230-1	DLFBHF09K1A
1	12,000	208/230-1	DLFBHF12K1A
1.5	18,000	208/230-1	DLFBHF18K1A

Note: Wireless remote controller included with each indoor unit. Wired remote control not available.

Accessories

Ordering Number	Description	For Models
KSACN0201AAA	Wired Remote Control	DLFBHB Indoor Unit Only
DLFBHC01K1A	Grille/Ceiling Panel	Cassette Indoor Units 12, 18
DLFBHC02K1A	Grille/Ceiling Panel	Cassette Indoor Units 24
KSAUI0201AAA	Multi Two-Port Branch Box	Multi-Zone 48, 56 (230v)
KASUI0401AAA	Multi Three-Port Branch Box	Multi-Zone 48, 56 (230v)
KSAUI0501AAA	Y-Type Branch Tube	Multi-Zone 48, 56 (230v)

DLCCAR, DLCCHR, DLFCAB, DLFCHB

Outdoor Cooling Only, Outdoor Heat Pump,
Indoor Cooling Only, Indoor Heat Pump
High Wall Ductless Split System
Sizes 09-36



High Wall Standard Features

- Variable-speed (Inverter)
- Modes: Cool, Heat, Dry, Fan, Auto
- Auto louver mode
- X-Fan mode
- Dehumidifying mode
- Four fan speeds
- Sleep mode
- Quiet operation
- 46° F heating mode (heating setback)
- I FEEL function

Control Features

- Wireless remote control (standard)
- Wired remote control (optional)

Unit Performance Data

Cooling Only – Variable-Speed System

System Tons	System Btuh	Volt-PH @ 60Hz	SEER	EER	Indoor Model Number	Outdoor Model Number
0.75	9,000	115-1	23.0	13.0	DLFCAB09J1A	DLCCAR09J1A
1	12,000	115-1	22.0	13.0	DLFCAB12J1A	DLCCAR12J1A
0.75	9,000	208/230-1	23.0	14.0	DLFCAB09K1A	DLCCAR09K1A
1	12,000	208/230-1	22.0	13.0	DLFCAB12K1A	DLCCAR12K1A
1.5	18,000	208/230-1	20.0	13.0	DLFCAB18K1A	DLCCAR18K1A
1.83	22,000	208/230-1	20.0	13.3	DLFCAB24K1A	DLCCAR24K1A
2.33	28,000	208/230-1	18.0	10.4	DLFCAB30K1A	DLCCAR30K1A
2.8	33,600	208/230-1	18.0	8.2	DLFCAB36K1A	DLCCAR36K1A

Wireless remote control included with indoor unit.

Heat Pump with Factory Installed Base Pan Heater – Variable-Speed System

System Tons	System Btuh	Volt-PH @ 60Hz	SEER	EER	HSPF	Indoor Model Number	Outdoor Model Number
0.75	9,000	115-1	23.0	12.9	10.5	DLFCHB09J1A	DLCCHR09J1A
1	12,000	115-1	22.0	12.5	10.2	DLFCHB12J1A	DLCCHR12J1A
0.75	9,000	208/230-1	23.0	14.3	10.5	DLFCHB09K1A	DLCCHR09K1A
1	12,000	208/230-1	22.0	12.5	10.1	DLFCHB12K1A	DLCCHR12K1A
1.5	18,000	208/230-1	20.0	12.5	10.0	DLFCHB18K1A	DLCCHR18K1A
1.83	22,000	208/230-1	20.0	12.5	10.0	DLFCHB24K1A	DLCCHR24K1A
2.33	28,000	208/230-1	18.0	10.4	9.0	DLFCHB30K1A	DLCCHR30K1A
2.8	33,600	208/230-1	18.0	8.2	9.0	DLFCHB36K1A	DLCCHR36K1A

Wireless remote control included with indoor unit.

Small Packaged Products



PGR5

Up to 16.0 SEER, Up to 12.5 EER Package Gas/Electric

2 – 5 Tons

208 / 230 Volt, Single-Phase, 60 Hz



Refrigeration Circuit

- Environmentally balanced R-410A refrigerant
- Copper tube/aluminum fin condenser and evaporator coils
- Tin-coated copper evaporator coil standard
- Two-stage scroll compressors standard on all models
- Two-stage gas valve and two-speed inducer motor on all models

Built to Last

- Hail guard (3/8" spacing) wire grilles standard
- Induced-draft combustion and venting
- High-efficiency ECM indoor blower motor on all models
- Pre-painted steel cabinet
- Direct spark ignition
- Stainless steel tubular heat exchanger standard
- Vertical condenser fan discharge
- Full perimeter steel base rails
- Crankcase heaters on select models
- High- and low-pressure switches provide added reliability for the compressor

Easy-to-Install and Service

- Installs easily on a rooftop or at ground level
- Easy three-panel accessibility for maintenance and installation
- Easily converts to down discharge applications
- Combination gas heating and electric cooling
- Low NOx units available

Warranty*

- Five-year No Hassle Replacement™ limited warranty
- 10-year parts limited warranty (including compressor and coils) and lifetime heat exchanger limited warranty with timely registration
- Five-year parts limited warranty and 20-year heat exchanger limited warranty if not registered within 90 days of original installation

* See warranty certificate for complete details and restrictions.

Unit Performance Data

Model Number	Net Capacity BTU/h High/Low	SEER	EER	Input BTU/h	Efficiency AFUE %	Unit Dimensions H x W x D Inches (mm)	Operating Weight lbs (kg)
PGR524040KGP*B	23,000	15.0	12.0	40,000/26,000	81.0	44-1/8 x 48-3/16 x 32-5/8 (1121 x 1224 x 829)	344 (156)
PGR524060KGP*B	23,000	15.0	12.0	60,000/39,000	81.0	44-1/8 x 48-3/16 x 32-5/8 (1121 x 1224 x 829)	344 (156)
PGR530040KGP*B	29,000	15.0	12.0	40,000/26,000	81.0	44-1/8 x 48-3/16 x 32-5/8 (1121 x 1224 x 829)	351 (159)
PGR530060KGP*B	29,000	15.0	12.0	60,000/39,000	81.0	44-1/8 x 48-3/16 x 32-5/8 (1121 x 1224 x 829)	351 (159)
PGR536060KGP*B	35,400	16.0	12.5	60,000/39,000	81.0	44-3/4 x 48-3/16 x 44-1/8 (1137 x 1224 x 1122)	447 (203)
PGR536090KGP*B	35,400	16.0	12.5	90,000/58,500	81.0	44-3/4 x 48-3/16 x 44-1/8 (1137 x 1224 x 1122)	447 (203)
PGR542060KGP*B	42,000	16.0	12.5	60,000/39,000	81.0	44-3/4 x 48-3/16 x 44-1/8 (1137 x 1224 x 1122)	447 (203)
PGR542090KGP*B	42,000	16.0	12.5	90,000/58,500	81.0	44-3/4 x 48-3/16 x 44-1/8 (1137 x 1224 x 1122)	447 (203)
PGR548090KGP*B	47,500	16.0	12.3	90,000/58,500	81.0	50-3/4 x 48-3/16 x 44-1/8 (1289 x 1224 x 1122)	492 (223)
PGR548115KGP*B	47,500	16.0	12.3	115,000/75,000	81.0	50-3/4 x 48-3/16 x 44-1/8 (1289 x 1224 x 1122)	492 (223)
PGR548130KGP*B	47,500	16.0	12.3	127,000/84,500	81.0	50-3/4 x 48-3/16 x 44-1/8 (1289 x 1224 x 1122)	492 (223)
PGR560090KGP*B	57,000	16.0	12.3	90,000/58,500	81.0	52-3/4 x 48-3/16 x 44-1/8 (1340 x 1224 x 1122)	512 (232)
PGR560115KGP*B	57,000	16.0	12.3	115,000/75,000	81.0	52-3/4 x 48-3/16 x 44-1/8 (1340 x 1224 x 1122)	512 (232)
PGR560130KGP*B	57,000	16.0	12.3	127,000/84,500	81.0	52-3/4 x 48-3/16 x 44-1/8 (1340 x 1224 x 1122)	512 (232)

* 0 = Standard, 1 = Low NOx



PGS4

Up to 14.5 SEER Package Gas/Electric

2 – 5 Tons
208 / 230 Volt, Single-Phase, 60 Hz

Refrigeration Circuit

- Environmentally balanced R-410A refrigerant
- Tin-coated copper evaporator coil standard
- Dehumidification mode (airflow reduction) on all models

Built to Last

- Stainless steel tubular heat exchanger
- Factory installed option for low cabinet air leakage and tin-coated copper evaporator main tubes (GC) (Models with factory installed options are identified with letters in the 11th and 12th positions in the model number)
- Hail guard (3/8" spacing) wire grilles on all models
- Induced-draft combustion and venting
- Direct spark ignition
- High-efficiency ECM indoor blower motor on all models
- Vertical condenser fan discharge
- Full perimeter steel base rails
- High-pressure switch provides added reliability for the compressor

Easy-to-Install and Service

- Installs easily on a rooftop or at ground level
- Easy three-panel accessibility for maintenance and installation
- Easily converts to down discharge applications
- Combination gas heating and electric cooling
- Low NOx units available

Warranty*

- Three-year No Hassle Replacement™ limited warranty
- 10-year parts limited warranty (including compressor and coils) with timely registration
- Five-year parts limited warranty and 20-year heat exchanger limited warranty if not registered within 90 days of original installation

* See warranty certificate for complete details and restrictions.

Unit Performance Data

Model Number	Cooling			Heating		Unit Dimensions H x W x D Inches (mm)	Operating Weight lbs (kg)
	Net Capacity BTU/h	SEER	EER	Input BTU/h	Efficiency AFUE %		
PGS424040KGP*E	23,600	14.0	11.5	40,000	81.0	43-3/4 x 48-3/16 x 32-5/8 (1111 x 1224 x 829)	304 (138)
PGS424060KGP*E	23,600	14.0	11.5	60,000	81.0	43-3/4 x 48-3/16 x 32-5/8 (1111 x 1224 x 829)	304 (138)
PGS430040KGC*E	28,600	14.0	11.5	40,000	81.0	45-3/4 x 48-3/16 x 32-5/8 (1162 x 1224 x 829)	336 (152)
PGS430040KGP*E	28,600	14.0	11.5	40,000	81.0	45-3/4 x 48-3/16 x 32-5/8 (1162 x 1224 x 829)	336 (152)
PGS430060KGC*E	28,600	14.0	11.5	60,000	81.0	45-3/4 x 48-3/16 x 32-5/8 (1162 x 1224 x 829)	336 (152)
PGS430060KGP*E	28,600	14.0	11.5	60,000	81.0	45-3/4 x 48-3/16 x 32-5/8 (1162 x 1224 x 829)	336 (152)
PGS436060KGC*E	34,800	14.0	11.5	60,000	81.0	51-3/4 x 48-3/16 x 32-5/8 (1315 x 1224 x 829)	349 (158)
PGS436060KGP*E	34,800	14.0	11.5	60,000	81.0	51-3/4 x 48-3/16 x 32-5/8 (1315 x 1224 x 829)	349 (158)
PGS436090KGC*E	34,800	14.0	11.5	90,000	81.0	51-3/4 x 48-3/16 x 32-5/8 (1315 x 1224 x 829)	349 (158)
PGS436090KGP*E	34,800	14.0	11.5	90,000	81.0	51-3/4 x 48-3/16 x 32-5/8 (1315 x 1224 x 829)	349 (158)
PGS442060KGC*E	41,000	14.0	11.5	60,000	81.0	44-3/4 x 48-3/16 x 44-1/8 (1137 x 1224 x 1122)	413 (187)
PGS442060KGP*E	41,000	14.0	11.5	60,000	81.0	44-3/4 x 48-3/16 x 44-1/8 (1137 x 1224 x 1122)	413 (187)
PGS442090KGC*E	41,000	14.0	11.5	90,000	81.0	44-3/4 x 48-3/16 x 44-1/8 (1137 x 1224 x 1122)	413 (187)
PGS442090KGP*E	41,000	14.0	11.5	90,000	81.0	44-3/4 x 48-3/16 x 44-1/8 (1137 x 1224 x 1122)	413 (187)

* 0 = Standard, 1 = Low NOx

PGS4 (con't)

Up to 14.5 SEER Package Gas/Electric

Unit Performance Data

Model Number	Cooling			Cooling		Unit Dimensions H x W x D Inches (mm)	Operating Weight lbs (kg)
	Net Capacity BTU/h	SEER	EER	Input BTU/h	Efficiency AFUE %		
PGS448090KGC*E	47,000	14.0	11.5	90,000	81.0	52-3/4 x 48-3/16 x 44-1/8 (1340 x 1224 x 1123)	438 (199)
PGS448090KGP*E	47,000	14.0	11.5	90,000	81.0	52-3/4 x 48-3/16 x 44-1/8 (1340 x 1224 x 1123)	438 (199)
PGS448115KGC*E	47,000	14.0	11.5	115,000	81.0	52-3/4 x 48-3/16 x 44-1/8 (1340 x 1224 x 1123)	438 (199)
PGS448115KGP*E	47,000	14.0	11.5	115,000	81.0	52-3/4 x 48-3/16 x 44-1/8 (1340 x 1224 x 1123)	438 (199)
PGS448130KGC*E	47,000	14.0	11.5	127,000	81.0	52-3/4 x 48-3/16 x 44-1/8 (1340 x 1224 x 1123)	438 (199)
PGS448130KGP*E	47,000	14.0	11.5	127,000	81.0	52-3/4 x 48-3/16 x 44-1/8 (1340 x 1224 x 1123)	438 (199)
PGS460090KGC*E	57,000	14.0	11.5	90,000	81.0	54-3/4 x 48-3/16 x 44-1/8 (1391 x 1224 x 1123)	455 (206)
PGS460090KGP*E	57,000	14.0	11.5	90,000	81.0	54-3/4 x 48-3/16 x 44-1/8 (1391 x 1224 x 1123)	455 (206)
PGS460115KGC*E	57,000	14.0	11.5	115,000	81.0	54-3/4 x 48-3/16 x 44-1/8 (1391 x 1224 x 1123)	455 (206)
PGS460115KGP*E	57,000	14.0	11.5	115,000	81.0	54-3/4 x 48-3/16 x 44-1/8 (1391 x 1224 x 1123)	455 (206)
PGS460130KGC*E	57,000	14.0	11.5	127,000	81.0	54-3/4 x 48-3/16 x 44-1/8 (1391 x 1224 x 1123)	455 (206)
PGS460130KGP*E	57,000	14.0	11.5	127,000	81.0	54-3/4 x 48-3/16 x 44-1/8 (1391 x 1224 x 1123)	455 (206)

* 0 = Standard, 1 = Low NOx

GP = Tin-plated evaporator main tubes plus stainless steel heat exchanger.

GC = Low cabinet air leakage plus tin-coated copper evaporator main tubes (30-60 sizes).



PGD4

Up to 14.5 SEER Package Gas/Electric

2 – 5 Tons
208 / 230 Volt, Single-Phase, 60 Hz

Refrigeration Circuit

- Environmentally balanced R-410A refrigerant
- Copper tube/aluminum fin condenser and evaporator coils
- Dehumidification mode (airflow reduction) on all models

Built to Last

- Wire grilles with 2" spacing on all models
- Tin-coated copper evaporator main tubes (TP) as factory installed option
- Induced-draft combustion and venting
- Direct spark ignition
- High-efficiency ECM indoor blower motor on all models
- Aluminized steel tubular heat exchanger
- Vertical condenser fan discharge
- Full perimeter steel base rails
- High-pressure switch provides added reliability for the compressor

Easy-to-Install and Service

- Installs easily on a rooftop or at ground level
- Easy three-panel accessibility for maintenance and installation
- Easily converts to down discharge applications
- Combination gas heating and electric cooling
- Low NOx units available

Warranty*

- 15-year heat exchanger limited warranty
- 10-year parts limited warranty (including compressor and coils) with timely registration
- Five-year parts limited warranty and 15-year heat exchanger limited warranty if not registered within 90 days of original installation

* See warranty certificate for complete details and restrictions.

Unit Performance Data

Model Number	Cooling			Heating		Unit Dimensions H x W x D Inches (mm)	Operating Weight lbs (kg)
	Net Capacity BTU/h	SEER	EER	Input BTU/h	Efficiency AFUE %		
PGD424040K00*E	23,600	14.0	11.5	40,000	81.0	43-3/4 x 48-3/16 x 32-5/8 (1111 x 1224 x 829)	304 (138)
PGD424040KTP*E	23,600	14.0	11.5	40,000	81.0	43-3/4 x 48-3/16 x 32-5/8 (1111 x 1224 x 829)	304 (138)
PGD424060K00*E	23,600	14.0	11.5	60,000	81.0	43-3/4 x 48-3/16 x 32-5/8 (1111 x 1224 x 829)	304 (138)
PGD424060KTP*E	23,600	14.0	11.5	60,000	81.0	43-3/4 x 48-3/16 x 32-5/8 (1111 x 1224 x 829)	304 (138)
PGD430040K00*E	28,600	14.0	11.5	40,000	81.0	45-3/4 x 48-3/16 x 32-5/8 (1162 x 1224 x 829)	336 (152)
PGD430040KTP*E	28,600	14.0	11.5	40,000	81.0	45-3/4 x 48-3/16 x 32-5/8 (1162 x 1224 x 829)	336 (152)
PGD430060K00*E	28,600	14.0	11.5	60,000	81.0	45-3/4 x 48-3/16 x 32-5/8 (1162 x 1224 x 829)	336 (152)
PGD430060KTP*E	28,600	14.0	11.5	60,000	81.0	45-3/4 x 48-3/16 x 32-5/8 (1162 x 1224 x 829)	336 (152)
PGD436060K00*E	34,200	14.0	11.5	60,000	81.0	51-3/4 x 48-3/16 x 32-5/8 (1315 x 1224 x 829)	349 (158)
PGD436060KTP*E	34,200	14.0	11.5	60,000	81.0	51-3/4 x 48-3/16 x 32-5/8 (1315 x 1224 x 829)	349 (158)
PGD436090K00*E	34,200	14.0	11.5	90,000	81.0	51-3/4 x 48-3/16 x 32-5/8 (1315 x 1224 x 829)	349 (158)
PGD436090KTP*E	34,200	14.0	11.5	90,000	81.0	51-3/4 x 48-3/16 x 32-5/8 (1315 x 1224 x 829)	349 (158)
PGD442060K00*E	41,000	14.0	11.5	60,000	81.0	44-3/4 x 48-3/16 x 44-1/8 (1137 x 1224 x 1123)	413 (187)
PGD442060KTP*E	41,000	14.0	11.5	60,000	81.0	44-3/4 x 48-3/16 x 44-1/8 (1137 x 1224 x 1123)	413 (187)
PGD442090K00*E	41,000	14.0	11.5	90,000	81.0	44-3/4 x 48-3/16 x 44-1/8 (1137 x 1224 x 1123)	413 (187)
PGD442090KTP*E	41,000	14.0	11.5	90,000	81.0	44-3/4 x 48-3/16 x 44-1/8 (1137 x 1224 x 1123)	413 (187)

PGD4 (con't)

Up to 14.5 SEER Package Gas/Electric

Unit Performance Data

Model Number	Cooling			Heating		Unit Dimensions H x W x D Inches (mm)	Operating Weight lbs (kg)
	Net Capacity BTU/h	SEER	EER	Input BTU/h	Efficiency AFUE %		
PGD448090K00*E	47,000	14.0	11.5	90,000	81.0	52-3/4 x 48-3/16 x 44-1/8 (1340 x 1224 x 1123)	438 (199)
PGD448090KTP*E	47,000	14.0	11.5	90,000	81.0	52-3/4 x 48-3/16 x 44-1/8 (1340 x 1224 x 1123)	438 (199)
PGD448115K00*E	47,000	14.0	11.5	115,000	81.0	52-3/4 x 48-3/16 x 44-1/8 (1340 x 1224 x 1123)	438 (199)
PGD448115KTP*E	47,000	14.0	11.5	115,000	81.0	52-3/4 x 48-3/16 x 44-1/8 (1340 x 1224 x 1123)	438 (199)
PGD448130K00*E	47,000	14.0	11.5	127,000	81.0	52-3/4 x 48-3/16 x 44-1/8 (1340 x 1224 x 1123)	438 (199)
PGD448130KTP*E	47,000	14.0	11.5	127,000	81.0	52-3/4 x 48-3/16 x 44-1/8 (1340 x 1224 x 1123)	438 (199)
PGD460090K00*E	57,000	14.0	11.5	90,000	81.0	54-3/4 x 48-3/16 x 44-1/8 (1391 x 1224 x 1123)	455 (206)
PGD460090KTP*E	57,000	14.0	11.5	90,000	81.0	54-3/4 x 48-3/16 x 44-1/8 (1391 x 1224 x 1123)	455 (206)
PGD460115K00*E	57,000	14.0	11.5	115,000	81.0	54-3/4 x 48-3/16 x 44-1/8 (1391 x 1224 x 1123)	455 (206)
PGD460115KTP*E	57,000	14.0	11.5	115,000	81.0	54-3/4 x 48-3/16 x 44-1/8 (1391 x 1224 x 1123)	455 (206)
PGD460130K00*E	57,000	14.0	11.5	127,000	81.0	54-3/4 x 48-3/16 x 44-1/8 (1391 x 1224 x 1123)	455 (206)
PGD460130KTP*E	57,000	14.0	11.5	127,000	81.0	54-3/4 x 48-3/16 x 44-1/8 (1391 x 1224 x 1123)	455 (206)

* 0 = Standard, 1 = Low NOx

00 = Standard

TP = Tin-plated evaporator main tubes plus stainless steel heat exchanger.



PDS4

Up to 14.5 SEER Package Dual Fuel Heat Pump

2 – 5 Tons
208 / 230 Volt, Single-Phase, 60 Hz

Refrigeration Circuit

- Environmentally balanced R-410A refrigerant
- Scroll compressor standard on all models
- Tin-coated copper evaporator main tubes standard
- Dehumidification mode (airflow reduction) on all models

Built to Last

- Stainless steel tubular heat exchanger standard
- Factory installed option for low cabinet air leakage and tin-coated copper evaporator main tubes (GC), (Models with factory installed options are identified with letters in the 11th and 12th positions in the model number)
- Hail guard (3/8" spacing) wire grilles standard all models
- Pre-painted steel cabinet
- Induced-draft combustion and venting
- Direct spark ignition
- High-efficiency ECM indoor blower motor on all models
- Vertical condenser fan discharge
- Full perimeter steel base rails
- High- and low-pressure switches provide added reliability for the compressor

Easy-to-Install and Service

- Installs easily on a rooftop or at ground level
- Easy three-panel accessibility for maintenance and installation
- Easily converts to down discharge applications
- Combination gas heating, heat pump heating and electric cooling
- Low NOx units available

Warranty*

- Three-year No Hassle Replacement™ limited warranty
- 10-year parts limited warranty (including compressor and coils) with timely registration and lifetime heat exchanger limited warranty with timely registration
- Five-year parts limited warranty and 20-year heat exchanger limited warranty if not registered within 90 days of original installation

* See warranty certificate for complete details and restrictions.

Unit Performance Data

Model Number	Cooling			Heating				Unit Dimensions H x W x D Inches (mm)	Operating Weight lbs (kg)
	Capacity BTU/h	SEER	EER	Capacity BTU/h	HSPF	Input BTU/h	Efficiency AFUE %		
PDS424040KGP*E	23,000	14.5	12.0	22,600	8.0	40,000	81.0	47-3/4 x 48-3/16 x 32-5/8 (1213 x 1224 x 829)	311 (141)
PDS424060KGP*E	23,000	14.5	12.0	22,600	8.0	60,000	81.0	47-3/4 x 48-3/16 x 32-5/8 (1213 x 1224 x 829)	311 (141)
PDS430040KGC*E	28,600	14.0	11.5	28,400	8.0	40,000	81.0	51-3/4 x 48-3/16 x 32-5/8 (1315 x 1224 x 829)	351 (159)
PDS430040KGP*E	28,600	14.0	11.5	28,400	8.0	40,000	81.0	51-3/4 x 48-3/16 x 32-5/8 (1315 x 1224 x 829)	351 (159)
PDS430060KGC*E	28,600	14.0	11.5	28,400	8.0	60,000	81.0	51-3/4 x 48-3/16 x 32-5/8 (1315 x 1224 x 829)	351 (159)
PDS430060KGP*E	28,600	14.0	11.5	28,400	8.0	60,000	81.0	51-3/4 x 48-3/16 x 32-5/8 (1315 x 1224 x 829)	351 (159)

* 0 = Standard, 1 = Low NOx

PDS4 (con't)

Up to 14.5 SEER Dual Fuel Heat Pump

Unit Performance Data

Model Number	Cooling			Heating				Unit Dimensions H x W x D Inches (mm)	Operating Weight lbs (kg)
	Capacity BTU/h	SEER	EER	Capacity BTU/h	HSPF	Input BTU/h	Efficiency AFUE %		
PDS436060KGC*E	34,200	14.0	11.5	34,400	8.0	60,000	81.0	48-3/4 x 48-3/16 x 44-1/8 (1238 x 1224 x 1122)	387 (176)
PDS436060KGP*E	34,200	14.0	11.5	34,400	8.0	60,000	81.0	48-3/4 x 48-3/16 x 44-1/8 (1238 x 1224 x 1122)	387 (176)
PDS436090KGC*E	34,200	14.0	11.5	34,400	8.0	90,000	81.0	48-3/4 x 48-3/16 x 44-1/8 (1238 x 1224 x 1122)	387 (176)
PDS436090KGP*E	34,200	14.0	11.5	34,400	8.0	90,000	81.0	48-3/4 x 48-3/16 x 44-1/8 (1238 x 1224 x 1122)	387 (176)
PDS442060KGC*E	41,000	14.0	11.5	40,000	8.0	60,000	81.0	54-3/4 x 48-3/16 x 44-1/8 (1391 x 1224 x 1122)	435 (197)
PDS442060KGP*E	41,000	14.0	11.5	40,000	8.0	60,000	81.0	54-3/4 x 48-3/16 x 44-1/8 (1391 x 1224 x 1122)	435 (197)
PDS442090KGC*E	41,000	14.0	11.5	40,000	8.0	90,000	81.0	54-3/4 x 48-3/16 x 44-1/8 (1391 x 1224 x 1122)	435 (197)
PDS442090KGP*E	41,000	14.0	11.5	40,000	8.0	90,000	81.0	54-3/4 x 48-3/16 x 44-1/8 (1391 x 1224 x 1122)	435 (197)
PDS448090KGC*E	48,000	14.0	12.0	46,000	8.0	90,000	81.0	54-3/4 x 48-3/16 x 44-1/8 (1391 x 1224 x 1122)	456 (207)
PDS448090KGP*E	48,000	14.0	12.0	46,000	8.0	90,000	81.0	54-3/4 x 48-3/16 x 44-1/8 (1391 x 1224 x 1122)	456 (207)
PDS448115KGC*E	48,000	14.0	12.0	46,000	8.0	115,000	81.0	54-3/4 x 48-3/16 x 44-1/8 (1391 x 1224 x 1122)	456 (207)
PDS448115KGP*E	48,000	14.0	12.0	46,000	8.0	115,000	81.0	54-3/4 x 48-3/16 x 44-1/8 (1391 x 1224 x 1122)	456 (207)
PDS448130KGC*E	48,000	14.0	12.0	46,000	8.0	130,000	81.0	54-3/4 x 48-3/16 x 44-1/8 (1391 x 1224 x 1122)	456 (207)
PDS448130KGP*E	48,000	14.0	12.0	46,000	8.0	130,000	81.0	54-3/4 x 48-3/16 x 44-1/8 (1391 x 1224 x 1122)	456 (207)
PDS460090KGC*E	57,500	14.0	11.5	57,500	8.0	90,000	81.0	48-3/4 x 48-3/16 x 44-1/8 (1238 x 1224 x 1122)	487 (221)
PDS460090KGP*E	57,500	14.0	11.5	57,500	8.0	90,000	81.0	48-3/4 x 48-3/16 x 44-1/8 (1238 x 1224 x 1122)	487 (221)
PDS460115KGC*E	57,500	14.0	11.5	57,500	8.0	115,000	81.0	48-3/4 x 48-3/16 x 44-1/8 (1238 x 1224 x 1122)	487 (221)
PDS460115KGP*E	57,500	14.0	11.5	57,500	8.0	115,000	81.0	48-3/4 x 48-3/16 x 44-1/8 (1238 x 1224 x 1122)	487 (221)
PDS460130KGC*E	57,500	14.0	11.5	57,500	8.0	130,000	81.0	48-3/4 x 48-3/16 x 44-1/8 (1238 x 1224 x 1122)	487 (221)
PDS460130KGP*E	57,500	14.0	11.5	57,500	8.0	130,000	81.0	48-3/4 x 48-3/16 x 44-1/8 (1238 x 1224 x 1122)	487 (221)

* 0 = Standard, 1 = Low NOx



PDD4

Up to 14.5 SEER Package Dual Fuel Heat Pump

2 – 5 Tons
208 / 230 Volt, Single-Phase, 60 Hz

Refrigeration Circuit

- Environmentally balanced R-410A refrigerant
- Scroll compressor standard on all models
- Copper tube/aluminum fin condenser and evaporator coils
- Dehumidification mode (airflow reduction) on all models

Built to Last

- Wire grilles with 2" spacing on all models
- Pre-painted steel cabinet
- Induced-draft combustion and venting
- Direct spark ignition
- High-efficiency ECM indoor blower motor on all models
- Aluminized steel tubular heat exchanger
- Vertical condenser fan discharge
- Full perimeter steel base rails
- High- and low-pressure switches provide added reliability for the compressor

Easy-to-Install and Service

- Installs easily on a rooftop or at ground level
- Easy three-panel accessibility for maintenance and installation
- Easily converts to down discharge applications
- Combination gas heating, heat pump heating and electric cooling
- Low NOx units available

Warranty*

- 15-year heat exchanger limited warranty
- 10-year parts limited warranty (including compressor and coils) with timely registration
- Five-year parts limited warranty if not registered within 90 days of original installation

* See warranty certificate for complete details and restrictions.

Unit Performance Data

Model Number	Cooling			Heating				Unit Dimensions H x W x D Inches (mm)	Operating Weight lbs (kg)
	Capacity BTU/h	SEER	EER	Capacity BTU/h	HSPF	Input BTU/h	Efficiency AFUE %		
PDD424040K00*E	23,000	14.5	12.0	22,600	8.0	40,000	81.0	47-3/4 x 48-3/16 x 32-5/8 (1213 x 1224 x 829)	311 (141)
PDD424060K00*E	23,000	14.5	12.0	22,600	8.0	60,000	81.0	47-3/4 x 48-3/16 x 32-5/8 (1213 x 1224 x 829)	311 (141)
PDD430040K00*E	28,600	14.0	14.0	28,400	8.0	40,000	81.0	51-3/4 x 48-3/16 x 32-5/8 (1315 x 1224 x 829)	351 (159)
PDD430060K00*E	28,600	14.0	14.0	28,400	8.0	60,000	81.0	51-3/4 x 48-3/16 x 32-5/8 (1315 x 1224 x 829)	351 (159)
PDD436060K00*E	34,200	14.0	11.5	34,400	8.0	60,000	81.0	48-3/4 x 48-3/16 x 44-1/8 (1238 x 1224 x 1122)	387 (176)
PDD436090K00*E	34,200	14.0	11.5	34,400	8.0	90,000	81.0	48-3/4 x 48-3/16 x 44-1/8 (1238 x 1224 x 1122)	387 (176)
PDD442060K00*E	41,000	14.0	11.5	40,000	8.0	60,000	81.0	54-3/4 x 48-3/16 x 44-1/8 (1391 x 1224 x 1122)	435 (197)
PDD442090K00*E	41,000	14.0	11.5	40,000	8.0	90,000	81.0	54-3/4 x 48-3/16 x 44-1/8 (1391 x 1224 x 1122)	435 (197)
PDD448090K00*E	48,000	14.0	12.0	46,000	8.0	90,000	81.0	54-3/4 x 48-3/16 x 44-1/8 (1391 x 1224 x 1122)	456 (207)
PDD448115K00*E	48,000	14.0	12.0	46,000	8.0	115,000	81.0	54-3/4 x 48-3/16 x 44-1/8 (1391 x 1224 x 1122)	456 (207)
PDD448130K00*E	48,000	14.0	12.0	46,000	8.0	130,000	81.0	54-3/4 x 48-3/16 x 44-1/8 (1391 x 1224 x 1122)	456 (207)
PDD460090K00*E	57,500	14.0	11.5	57,500	8.0	90,000	81.0	48-3/4 x 48-3/16 x 44-1/8 (1238 x 1224 x 1122)	487 (221)
PDD460115K00*E	57,500	14.0	11.5	57,500	8.0	115,000	81.0	48-3/4 x 48-3/16 x 44-1/8 (1238 x 1224 x 1122)	487 (221)
PDD460130K00*E	57,500	14.0	11.5	57,500	8.0	130,000	81.0	48-3/4 x 48-3/16 x 44-1/8 (1238 x 1224 x 1122)	487 (221)

PAR5

Up to 16.0 SEER, Up to 12.5 EER Package Air Conditioner

2 – 5 Tons

208 / 230 Volt, Single-Phase, 60 Hz



Refrigeration Circuit

- Environmentally balanced R-410A refrigerant
- Tin-coated copper evaporator coil standard
- Enhanced dehumidification feature on high-stage cooling with use of a dehumidistat
- Two-stage scroll compressors standard on all models

Built to Last

- Hail guard (3/8" spacing) wire grilles standard
- Multi-speed ECM blower motor standard on all models
- Pre-painted steel cabinet
- Vertical condenser fan discharge
- Full perimeter steel base rails
- High- and low-pressure switches provide added reliability for the compressor

Easy-to-Install and Service

- Installs easily on a rooftop or at ground level
- Easy three-panel accessibility for maintenance and installation
- Easily converts to down discharge applications

Warranty*

- Five-year No Hassle Replacement™ limited warranty for models with tin-coated copper evaporator coil
- Five-year parts limited warranty (including compressor and coils)
 - With timely registration, an additional five-year parts limited warranty (including compressor and coils)

* See warranty certificate for complete details.
For residential applications only. See warranty certificate for complete details and restrictions, including warranty coverage for other applications.

Unit Performance Data

Model Number	Net Capacity BTU/h High	Standard CFM High/Low	SEER	EER	Unit Dimensions H x W x D Inches (mm)	Operating Weight lbs (kg)
PAR524000KTP0A	23,000	800/600	15.0	12.0	44-1/8 x 48-3/16 x 31-3/16 (1121 x 1224 x 792)	327 (148)
PAR530000KTP0A	29,000	1000/750	15.0	12.0	46-1/8 x 48-3/16 x 31-3/16 (1172 x 1224 x 829)	334 (152)
PAR536000KTP0A	35,400	1200/900	16.0	12.5	44-3/4 x 48-1/4 x 42-15/16 (1137 x 1226 x 1091)	389 (176)
PAR542000KTP0A	42,000	1400/1050	16.0	12.5	50-3/4 x 48-1/4 x 42-15/16 (1289 x 1226 x 1091)	392 (178)
PAR548000KTP0A	47,500	1600/1200	16.0	12.3	48-3/4 x 48-1/4 x 42-15/16 (1238 x 1226 x 1091)	444 (201)
PAR560000KTP0A	57,000	1750/1200	16.0	12.3	54-3/4 x 48-1/4 x 42-15/16 (1391 x 1226 x 1091)	464 (211)



PHR5

Up to 15.5 SEER, Up to 12.5 EER, Up to 8.5 HSPF
Package Heat Pump

2 – 5 Tons
208 / 230 Volt, Single-Phase, 60 Hz

Refrigeration Circuit

- Environmentally balanced R-410A refrigerant
- Copper tube/aluminum fin condenser and evaporator coils
- Tin-coated copper evaporator coil standard
- Enhanced dehumidification feature on high-stage cooling with use of a dehumidistat
- Two-stage scroll compressors standard on all models

Built to Last

- Hail guard (3/8" spacing) wire grilles standard
- Multi-speed ECM blower motor standard on all models
- Pre-painted steel cabinet
- Vertical condenser fan discharge
- Full perimeter steel base rails
- High- and low-pressure switches provide added reliability for the compressor

Easy-to-Install and Service

- Installs easily on a rooftop or at ground level
- Easy three-panel accessibility for maintenance and installation
- Easily converts to down discharge applications

Warranty*

- Five-year No Hassle Replacement™ limited warranty for models with tin-coated copper evaporator coil
- Five-year parts limited warranty (including compressor and coils)
 - With timely registration, an additional five-year parts limited warranty (including compressor and coils)

* See warranty certificate for complete details.
For residential applications only. See warranty certificate for complete details and restrictions, including warranty coverage for other applications.

Unit Performance Data

Model Number	Net Capacity BTU/h High	Standard CFM High/Low	SEER	EER	HSPF	COP	Unit Dimensions H x W x D Inches (mm)	Operating Weight lbs (kg)
PHR524000KTP0B	22,800	855/675	15.0	12.0	8.2	3.9	51-3/4 x 47 x 32-5/8 (1315 x 1194 x 829)	338 (153)
PHR530000KTP0B	29,400	1000/775	15.0	12.0	8.2	3.7	51-3/4 x 47 x 32-5/8 (1315 x 1194 x 829)	384 (174)
PHR536000KTP0A	34,000	1200/900	15.0	12.0	8.2	3.7	44-3/4 x 48-1/4 x 44-3/16 (1137 x 1226 x 1122)	413 (187)
PHR542000KTP0A	42,000	1400/1050	15.0	12.0	8.2	3.6	50-3/4 x 48-1/4 x 44-3/16 (1289 x 1226 x 1122)	444 (201)
PHR548000KTP0A	47,500	1600/1200	15.0	12.5	8.2	3.7	48-3/4 x 48-1/4 x 44-3/16 (1238 x 1226 x 1122)	447 (203)
PHR560000KTP0A	57,000	1750/1200	15.0	12.0	8.5	3.5	54-3/4 x 48-1/4 x 44-3/16 (1391 x 1226 x 1122)	503 (228)

PAD4

Up to 14.5 SEER, 12.0 EER Package Air Conditioner

2 – 5 Tons

208 / 230 Volt, Single-Phase, 60 Hz



Refrigeration Circuit

- Environmentally balanced R-410A refrigerant
- Copper tube/aluminum fin condenser and evaporator coils
- Dehumidification mode (airflow reduction) on all models

Built to Last

- Factory installed option for low cabinet air leakage and tin-coated copper evaporator main tubes (LC)
- Available with optional factory installed tin-coated copper evaporator coil with 3/8" spacing wire grilles standard as hail guard (TP), all other models have 2" spacing wire grilles (Models with factory installed options are identified with letters in the 11th and 12th positions in the model number)
- High-efficiency ECM indoor blower motor on all models
- Vertical condenser fan discharge
- Full perimeter steel base rails
- High-pressure switch provides added reliability for the compressor

Easy-to-Install and Service

- Installs easily on a rooftop or at ground level
- Easy three-panel accessibility for maintenance and installation
- Easily converts to down discharge applications

Warranty*

- Three-year No Hassle Replacement™ limited warranty for tin-coated 'TP' models
- 10-year parts limited warranty (including compressor and coils) with timely registration
- Five-year parts limited warranty if not registered within 90 days of original installation

* See warranty certificate for complete details and restrictions.

Unit Performance Data

Model Number	Net Capacity BTU/h High	SEER	EER	Unit Dimensions H x W x D Inches (mm)	Operating Weight lbs (kg)
PAD424000K000E	23,000	14.0	11.5	43-3/4 x 48-3/16 x 32-5/8 (1111 x 1224 x 829)	304 (138)
PAD424000KTPOE	23,000	14.0	11.5	43-3/4 x 48-3/16 x 32-5/8 (1111 x 1224 x 829)	304 (138)
PAD430000K000E	28,600	14.0	11.5	45-3/4 x 48-3/16 x 32-5/8 (1162 x 1224 x 829)	336 (152)
PAD430000KLCOE	28,600	14.0	11.5	45-3/4 x 48-3/16 x 32-5/8 (1162 x 1224 x 829)	336 (152)
PAD430000KTPOE	28,600	14.0	11.5	45-3/4 x 48-3/16 x 32-5/8 (1162 x 1224 x 829)	336 (152)
PAD436000K000E	34,800	14.0	11.5	51-3/4 x 48-3/16 x 32-5/8 (1315 x 1224 x 829)	349 (158)
PAD436000KLCOE	34,800	14.0	11.5	51-3/4 x 48-3/16 x 32-5/8 (1315 x 1224 x 829)	349 (158)
PAD436000KTPOE	34,800	14.0	11.5	51-3/4 x 48-3/16 x 32-5/8 (1315 x 1224 x 829)	349 (158)
PAD442000K000E	40,000	14.0	11.5	44-3/4 x 48-1/4 x 44-3/16 (1137 x 1226 x 1123)	413 (187)
PAD442000KLCOE	40,000	14.0	11.5	44-3/4 x 48-1/4 x 44-3/16 (1137 x 1226 x 1123)	413 (187)
PAD442000KTPOE	40,000	14.0	11.5	44-3/4 x 48-1/4 x 44-3/16 (1137 x 1226 x 1123)	413 (187)
PAD448000K000E	46,000	14.0	11.5	52-3/4 x 48-1/4 x 44-3/16 (1340 x 1226 x 1123)	438 (199)
PAD448000KLCOE	46,000	14.0	11.5	52-3/4 x 48-1/4 x 44-3/16 (1340 x 1226 x 1123)	438 (199)
PAD460000K000E	56,000	14.0	11.5	54-3/4 x 48-1/4 x 44-3/16 (1391 x 1226 x 1123)	455 (206)
PAD460000KLCOE	56,000	14.0	11.5	54-3/4 x 48-1/4 x 44-3/16 (1391 x 1226 x 1123)	455 (206)



PHD4

Up to 14.5 SEER, Up to 12.5 EER Package Air Conditioner

2 – 5 Tons
208 / 230 Volt, Single-Phase, 60 Hz

Refrigeration Circuit

- Environmentally balanced R-410A refrigerant
- Copper tube/aluminum fin condenser and evaporator coils
- Scroll compressor standard on all models
- Short-cycling protection for the compressor is built into the defrost control board
- Dehumidification mode (airflow reduction) on all models

Built to Last

- Factory installed optional for tin-coated copper evaporator coil with 3/8" spacing wire grilles standard as hail guard (TP)
- Factory installed option for low cabinet air leakage and factory installed tin-coated copper evaporator main tubes (LC) (Models with factory installed options are identified with letters in the 11th and 12th positions in the model number)
- Direct drive high-efficiency ECM indoor blower motor on all models
- Vertical condenser fan discharge
- Full perimeter steel base rails
- High- and low-pressure switches provide added reliability for the compressor

Easy-to-Install and Service

- Installs easily on a rooftop or at ground level
- Easy three-panel accessibility for maintenance and installation
- Easily converts to down discharge applications
- Combination electric heating and cooling

Warranty*

- Three-year No Hassle Replacement™ limited warranty for tin-coated 'TP' models
- 10-year parts limited warranty (including compressor and coils) with timely registration

* See warranty certificate for complete details and restrictions.

Unit Performance Data

Model Number	Cooling			Heating		Unit Dimensions H x W x D Inches (mm)	Operating Weight lbs (kg)
	Capacity BTU/h	SEER	EER	Capacity BTU/h	HSPF		
PHD424000K000F	23,000	14.5	12.5	22,600	8.0	47-3/4 x 48-3/16 x 32-5/8 (1213 x 1224 x 829)	311 (141)
PHD424000KTPOF	23,000	14.5	12.5	22,600	8.0	47-3/4 x 48-3/16 x 32-5/8 (1213 x 1224 x 829)	311 (141)
PHD430000K000F	28,600	14.0	11.5	28,400	8.0	51-3/4 x 48-3/16 x 32-5/8 (1315 x 1224 x 829)	351 (159)
PHD430000KLCOF	28,600	14.0	11.5	28,400	8.0	51-3/4 x 48-3/16 x 32-5/8 (1315 x 1224 x 829)	351 (159)
PHD430000KTPOF	28,600	14.0	11.5	28,400	8.0	51-3/4 x 48-3/16 x 32-5/8 (1315 x 1224 x 829)	351 (159)
PHD436000K000F	34,200	14.0	11.5	34,400	8.0	48-3/4 x 48-3/16 x 44-3/16 (1137 x 1224 x 1122)	387 (176)
PHD436000KLCOF	34,200	14.0	11.5	34,400	8.0	48-3/4 x 48-3/16 x 44-3/16 (1137 x 1224 x 1122)	387 (176)
PHD436000KTPOF	34,200	14.0	11.5	34,400	8.0	48-3/4 x 48-3/16 x 44-3/16 (1137 x 1224 x 1122)	387 (176)
PHD442000K000F	41,000	14.0	11.5	40,000	8.0	54-3/4 x 48-3/16 x 44-3/16 (1238 x 1224 x 1122)	435(197)
PHD442000KLCOF	41,000	14.0	11.5	40,000	8.0	54-3/4 x 48-3/16 x 44-3/16 (1238 x 1224 x 1122)	435(197)
PHD442000KTPOF	41,000	14.0	11.5	40,000	8.0	54-3/4 x 48-3/16 x 44-3/16 (1238 x 1224 x 1122)	435(197)
PHD448000K000F	48,000	14.0	12.0	46,000	8.0	54-3/4 x 48-3/16 x 44-3/16 (1238 x 1224 x 1122)	456 (207)
PHD448000KLCOF	48,000	14.0	12.0	46,000	8.0	54-3/4 x 48-3/16 x 44-3/16 (1238 x 1224 x 1122)	456 (207)
PHD448000KTPOF	48,000	14.0	12.0	46,000	8.0	54-3/4 x 48-3/16 x 44-3/16 (1238 x 1224 x 1122)	456 (207)
PHD460000K000F	57,500	14.0	11.5	57,500	8.0	48-3/4 x 48-3/16 x 44-3/16 (1391 x 1224 x 1122)	487 (221)
PHD460000KLCOF	57,500	14.0	11.5	57,500	8.0	48-3/4 x 48-3/16 x 44-3/16 (1391 x 1224 x 1122)	487 (221)
PHD460000KTPOF	57,500	14.0	11.5	57,500	8.0	48-3/4 x 48-3/16 x 44-3/16 (1391 x 1224 x 1122)	487 (221)

PAJ4

Up to 14.5 SEER, R-410A Package Air Conditioner for Manufactured Housing, Residential and Light Commercial Applications

2 – 5 Tons

208 / 230 Volt, Single-Phase, 60 Hz



Refrigeration Circuit

- Environmentally balanced R-410A refrigerant
- Liquid refrigerant filter driers
- Copper tube/aluminum fin condenser and evaporator coils

Built to Last

- Cabinet air leakage less than 2.0% at 1-inch water column and cabinet air leakage less than 1.4% at 0.5-inch water column when tested in accordance with ASHRAE Standard 193 (Models with factory installed options are identified with letters in the 11th and 12th positions in the model number)
- Vibration isolation provides quiet operation
- Compressors have internal over current protection
- Direct-drive multi-speed blower motor standard on all models
- No-rust base pan with integrated drain pan standard on all units
- Durable pre-painted steel cabinet
- Louvered coil enclosure for protection against vandalism and hail damage
- Aerodynamic fan blade design reduces the overall sound
- All models available with optional factory installed tin-coated copper evaporator coil (These models are identified with letters TP in the 11th and 12th positions in the model number)

Easy-to-Install and Service

- Light weight, compact construction ideal for manufactured housing and residential applications
- Hand holds built into the unit base pan
- Compact, fully self-contained, electric cooling unit with horizontal supply and return ducts
- Easy panel accessibility for maintenance and installation
- Accessory electric heaters with single point connections
- Designed to be serviced from both the side and front

Warranty*

- 10-year parts limited warranty (including compressor and coils) with timely registration
- Five-year parts limited warranty if not registered within 90 days of original installation

* See warranty certificate for complete details and restrictions.

Unit Performance Data

Model Number	Nominal Tons	Capacity BTU/h	SEER	EER	Unit Dimensions H x W x D Inches (mm)	Operating Weight lbs (kg)
PAJ424000K000A	2.0	22,400	14.0	11.5	30-1/8 x 51 x 32 (765 x 1295 x 813)	230 (104)
PAJ424000KTPOA	2.0	22,400	14.0	11.5	30-1/8 x 51 x 32 (765 x 1295 x 813)	230 (104)
PAJ430000K000A	2.5	28,600	14.0	11.5	30-1/8 x 51 x 32 (765 x 1295 x 813)	249 (113)
PAJ430000KTPOA	2.5	28,600	14.0	11.5	30-1/8 x 51 x 32 (765 x 1295 x 813)	249 (113)
PAJ436000K000A	3.0	35,000	14.0	11.5	30-1/8 x 51 x 32 (765 x 1295 x 813)	272 (123)
PAJ436000KTPOA	3.0	35,000	14.0	11.5	30-1/8 x 51 x 32 (765 x 1295 x 813)	272 (123)
PAJ442000K000A	3.5	41,000	14.5	11.5	34-1/8 x 51 x 32 (867 x 1295 x 813)	275 (125)
PAJ442000KTPOA	3.5	41,000	14.5	11.5	34-1/8 x 51 x 32 (867 x 1295 x 813)	275 (125)
PAJ448000K000A	4.0	47,000	14.0	11.5	42-1/8 x 51 x 32 (1070 x 1295 x 813)	318 (144)
PAJ448000KTPOA	4.0	47,000	14.0	11.5	42-1/8 x 51 x 32 (1070 x 1295 x 813)	318 (144)
PAJ460000K000A	5.0	54,000	14.0	11.3	42-1/8 x 51 x 32 (1070 x 1295 x 813)	344 (156)
PAJ460000KTPOA	5.0	54,000	14.0	11.3	42-1/8 x 51 x 32 (1070 x 1295 x 813)	344 (156)



24-48 Sizes

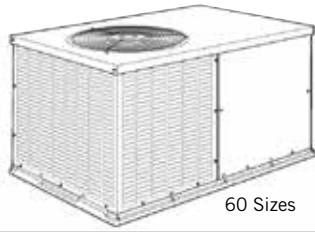

60 Sizes

PHJ4

Up to 14.5 SEER, R-410A Package Heat Pump for Manufactured Housing, Residential and Light Commercial Applications

2 – 5 Tons
208 / 230 Volt, Single-Phase, 60 Hz

Refrigeration Circuit

- Environmentally balanced R-410A refrigerant
- Liquid refrigerant filter driers
- Copper tube/aluminum fin condenser and evaporator coils

Built to Last

- Vibration isolation provides quiet operation
- Compressors have internal over current protection
- Direct-drive multi-speed blower motor standard on all models
- No-rust base pan with integrated drain pan standard on all units
- Durable pre-painted steel cabinet
- Louvered coil enclosure for protection against vandalism and hail damage
- Aerodynamic fan blade design reduces the overall sound
- All models available with optional factory installed tin-coated copper evaporator coil (These models are identified with letters TP in the 11th and 12th positions in the model number)

Warranty*

- 10-year parts limited warranty (including compressor and coils) with timely registration
- Five-year parts limited warranty if not registered within 90 days of original installation

* See warranty certificate for complete details and restrictions.

Easy-to-Install and Service

- Light weight, compact construction ideal for manufactured housing and residential applications
- Hand holds built into the unit base pan
- Compact, fully self-contained, electric cooling and heating unit with horizontal supply and return ducts
- Easy panel accessibility for maintenance and installation
- Accessory electric heaters with single point connections
- Designed to be serviced from both the side and front
- Cabinet air leakage less than 2.0% at 1-inch water column and cabinet air leakage less than 1.4% at 0.5-inch water column when tested in accordance with ASHRAE Standard 193
- All models available with optional factory installed tin-coated copper evaporator coil (Models with factory installed options are identified with letters TP in the 11th and 12th positions in the model number)

Unit Performance Data

Model Number	Cooling			Heating		Unit Dimensions H x W x D Inches (mm)	Operating Weight lbs (kg)
	Capacity BTU/h	SEER	EER	Capacity BTU/h	HSPF		
PHJ424000K000A	24,000	14.5	11.5	23,400	8.0	30-1/8 x 51 x 32 (765 x 1295 x 813)	253 (115)
PHJ424000KTPOA	24,000	14.5	11.5	23,400	8.0	30-1/8 x 51 x 32 (765 x 1295 x 813)	253 (115)
PHJ430000K000A	29,800	14.5	11.5	28,600	8.0	34-1/8 x 51 x 32 (867 x 1295 x 813)	283 (128)
PHJ430000KTPOA	29,800	14.5	11.5	28,600	8.0	34-1/8 x 51 x 32 (867 x 1295 x 813)	283 (128)
PHJ436000K000A	36,000	14.5	11.5	34,400	8.0	34-1/8 x 51 x 32 (867 x 1295 x 813)	285 (130)
PHJ436000KTPOA	36,000	14.5	11.5	34,400	8.0	34-1/8 x 51 x 32 (867 x 1295 x 813)	285 (130)
PHJ442000K000A	42,000	14.5	11.5	40,000	8.0	42-1/8 x 51 x 32 (1070 x 1295 x 813)	339 (154)
PHJ442000KTPOA	42,000	14.5	11.5	40,000	8.0	42-1/8 x 51 x 32 (1070 x 1295 x 813)	339 (154)
PHJ448000K000A	46,500	14.0	11.5	45,000	8.0	42-1/8 x 51 x 32 (1070 x 1295 x 813)	358 (163)
PHJ448000KTPOA	46,500	14.0	11.5	45,000	8.0	42-1/8 x 51 x 32 (1070 x 1295 x 813)	358 (163)
PHJ460000K000A	55,000	14.0	11.0	56,000	8.0	42-1/8 x 51 x 32 (1070 x 1295 x 813)	425 (193)
PHJ460000KTPOA	55,000	14.0	11.0	56,000	8.0	42-1/8 x 51 x 32 (1070 x 1295 x 813)	425 (193)

Accessories

PAR5, PHR5, PGR5 Single-Phase Models

Model Number	Description	Use With
Electric Heaters		PHR5
Model	Nominal Capacity (kW) – Fused/Stages	
CPHEATER052A0*	3.8 / 5.0 - No / 1	24 - 36
CPHEATER064A0*	3.8 / 5.0 - Yes / 1	ALL
CPHEATER069A0*	5.4 / 7.2 - No / 2	24
CPHEATER070A0*	5.4 / 7.2 - Yes / 2	ALL
CPHEATER050A0*	7.5 / 10.0 - Yes / 2	ALL
CPHEATER066A0*	11.3 / 15.0 - Yes / 2	30 - 60
CPHEATER054A0*	15.0 / 20.0 - Yes / 2	42 - 60
Economizer		PDR5, PAR5
Model	Nominal Capacity (kW)	Use With
ECD-SDSML-JC2-ADB*	Two-stage compatible vertical economizer with Jade Honeywell W7220 controller, Honeywell actuator, and dry bulb sensor.	24 - 30
ECD-SDLGS-JC2-ADB*		36 - 42
ECD-SDLGB-JC2-ADB*		48 - 60
ECH-SDSML-JC2-ADB*	Two-stage compatible horizontal economizer with Jade Honeywell W7220 controller, Honeywell actuator, and dry bulb sensor.	24 - 30
ECH-SDLGS-JC2-ADB*		36 - 42
ECH-SDLGB-JC2-ADB*		48 - 60

*Contact MicroMetl Customer Service at 1-800-662-4822 to order.

Thermostats		
Model	Description	Use With
TSTAT0408	Universal Programmable Thermostat with Humidity Sensing and Control, Dual Fuel compatible, two-stage cool, two-stage gas heat, two-stage HP heat, two-stage electric heat	ALL
TSTAT0201CW	Observer® Communicating Touchscreen Thermostat with Humidity Sensing and Control, Dual Fuel compatible, two-stage cool, two-stage gas heat, two-stage HP heat, two-stage electric heat	ALL†
NAXA00101DB	Daughter Board, use with communicating thermostat TSTAT0201CW and non-communicating equipment	ALL

*Relay 1184479 is required with this Low-Ambient Control when used in heat pump application.

†Daughter board required for use with TSTAT0201CW and non-communicating unit.

Accessories PAR5, PHR5, PGR5 Single-Phase Models

Model Number	Description	Use with PGR5, PAR5, PHR5
Curbs		
CPRFCURB011A00	Roof Curb, 14" High	24 - 60
CPRFCURB013A00	Roof Curb, 14" High	36 - 60
Note: CPRFCURB011A00 can be used with 36-60 units with some overhang.		
Adapter Curbs*		
CPADCURB001A00	Adapter Curb, for use with NPRFCURB006A00 & NPRFCURB007A00	24 - 30
CPADCURB002A00	Adapter Curb, for use with NPRFCURB008A00 & NPRFCURB009A00	36 - 60
*Can also be used when replacing other manufacturer's older generation units that contain a composite base without a metal base rail.		
Concentric Adaptors (use with curb only)		
NPCONADP001A00	For 18" round duct (*use with curb CPRFCURB011A00)	Small Curb
NPCONADP002A00	For 18" round duct (*use with curb CPRFCURB013A00)	Large Curb
Dampers		
CPMANDPRO07A00	Manual Outside Air Damper – (includes filter rack and 1" filter – same as CPFILTRK kit)	24 - 30
CPMANDPRO08A00		36 - 42
CPMANDPRO09A00		48 - 60
Internal Filter Racks		
CPFILTRK007A00	Internal Filter Rack (includes 1" filters)	24 - 30
CPFILTRK008A00	Internal Filter Rack (includes 1" filters)	36 - 42
CPFILTRK009A00	Internal Filter Rack (includes 1" filters)	48 - 60
Crankcase Heater (factory installed on some models)		
CPCRKHTR008A00	Crankcase Heater	24 - 36
CPCRKHTR004A00	Crankcase Heater	42 - 48
Low-Ambient, Anti-Cycle Timer, Compressor Start Assist		
CPLOWAMB001A00	Low-Ambient Control – Enables cooling system to operate down to 0° F by cycling condenser fan on and off.*	ALL
NRTIMEGD001A00	Five Minute Compressor Delay	ALL
NPHSTART001A00	PTC Compressor Start Assist Kit	ALL
Gas Conversion Kits		
NPLPCONV013C00	Natural to LP Conversion Kit (0 - 2000')	ALL
NPLPCONV014C00	Natural to LP Conversion Kit (2001' - 6000')	ALL
NPNGCONV004B00	LP to Natural Gas Conversion Kit (0 - 2000')	ALL
Flue Discharge Deflector		
CRFLUEDS001A00	Directs flue gas exhaust 90° upward from current discharge. Designed to allow tighter distances between unit and combustible surfaces. 24" height. AGA certified.	ALL
Duct Transitions		
NPDUCFLG002A00	Square to 14" round (one set of two, use with horizontal duct flanges only)	24 - 48
Electric Heaters		PAR5
Model	Nominal Capacity (kW) – Fused/Stages	
CPHEATER052A0*	3.8 / 5.0 - No / 1	ALL
CPHEATER064A0*	3.8 / 5.0 - Yes / 1	ALL
CPHEATER069A0*	5.4 / 7.2 - No / 2	ALL
CPHEATER070A0*	5.4 / 7.2 - Yes / 2	ALL
CPHEATER065A0*	7.5 / 10.0 - No / 2	24 - 42
CPHEATER050A0*	7.5 / 10.0 - Yes / 2	ALL
CPHEATER051A0*	11.3 / 15.0 - Yes / 2	30 - 42
CPHEATER066A0*	11.3 / 15.0 - Yes / 2	30 - 60
CPHEATER053A0*	15.0 / 20.0 - Yes / 2	42
CPHEATER054A0*	15.0 / 20.0 - Yes / 2	42 - 60

*Relay 1184479 is required with this Low-Ambient Control when used in heat pump application.

Specifications subject to change without notice.

Accessories

PGS4-E, PGD4-E, PDS4-E, PDD4-E, PAD4-E, PHD4-E Single-Phase Models

Model Number	Description	Use With		
		PDS4, PDD4	PGD4, PGS4, PAD4	PHD4
Curbs				
CPRFCURB011A00	Roof Curb, 14" High	24 - 30	24 - 60	24 - 30
CPRFCURB013A00	Roof Curb, 14" High	36 - 60	42 - 60	36 - 60
Note: CPRFCURB011A00 can be used with PGD442-60, PGS442-60, PAD442-60 units with some overhang.				
Adapter Curbs*				
CPADCURB001A00	Adapter Curb, for use with NPRFCURB006A00 and NPRFCURB007A00	24 - 30	24 - 36	24 - 30
CPADCURB002A00	Adapter Curb, for use with NPRFCURB008A00 and NPRFCURB009A00	36 - 60	42 - 60	36 - 60
*Can also be used when replacing other manufacturer's older generation units that contain a composite base without a metal base rail.				
Concentric Adaptors (Use with curb only)				
NPCONADP001A00	For 18" round duct (use with curb CPRFCURB011A00)	Small Curb		
NPCONADP002A00	For 18" round duct (use with curb CPRFCURB013A00)	Large Curb		
Economizers				
CPECOMZR007B00	Dedicated Vertical Economizer – Internal with solid state controller, gear driven, fully modulating damper, spring return actuator, up to 50% barometric relief, supply and dry bulb outdoor air sensors. Includes filter rack with 1" filters.*	24 - 30	24 - 36	24 - 30
CPECOMZR008A00		42, 48	42, 48	42, 48
CPECOMZR009A00		36, 60	60	36, 60
CPECOMZR010A00	Dedicated Horizontal Economizer – Internal with solid state controller, fully modulating damper, spring return actuator, supply and dry bulb outdoor air sensor, and low-ambient compressor lockout switch included. Includes filter rack with 1" filters.*	24 - 30	24 - 36	24 - 30
CPECOMZR011A00		42, 48	42, 48	42, 48
CPECOMZR012A00		36, 60	60	36, 60
CPRLYKIT001A00	Economizer Relay for Heat Pumps	ALL	ALL	ALL
Dampers				
CPMANDPR007A00	Manual Outside Air Damper – Includes filter rack and 1" filter (same as CPFILTRK kit)	24 - 30	24 - 36	24 - 30
CPMANDPR008A00		42, 48	42 - 48	42, 48
CPMANDPR009A00		36, 60	60	36, 60
Internal Filter Racks				
CPFILTRK007A00	Internal Filter Rack (includes 1" filters)	24 - 30	24 - 36	24 - 30
CPFILTRK008A00	Internal Filter Rack (includes 1" filters)	42, 48	42, 48	42, 48
CPFILTRK009A00	Internal Filter Rack (includes 1" filters)	36, 60	60	36, 60
Low-Ambient, Anti-Cycle Timer, Compressor Start Assist				
CPLOWAMB001A00*	Low-Ambient Control – Enables cooling system to operate down to 0° F by cycling condenser fan on and off.*	ALL	ALL	ALL
NRTIMEGD001A00	Five Minute Compressor Delay	ALL	ALL	ALL
NPHSTART002A00	PTC Compressor Start Assist Kit	ALL	ALL	ALL
Crankcase Heater - Belly Band Type				
CPCRKHTR008A00	240V Crankcase Heater	24 - 36	24, 36	24 - 36
CPCRKHTR004A00	240V Crankcase Heater (included on 48 and 60 size models)	42 - 60	30, 42 - 60	42 - 60
Gas Conversion Kits				
NPLPCONV013C00	Natural to LP Conversion Kit (0 - 2000')	ALL	ALL	ALL
NPLPCONV014C00	Natural to LP Conversion Kit (2001' - 6000')	ALL	ALL	ALL
NPNGCONV004C00	LP to Natural Gas Conversion Kit (0 - 2000')	ALL	ALL	ALL

*Relay 1184479 is required with this Low-Ambient Control when used in heat pump application.

Accessories

PGS4-E, PGD4-E, PDS4-E, PDD4-E, PAD4-E, PHD4-E Single-Phase Models

Model Number	Description	Use With		
		PDS4, PDD4	PGD4, PGS4, PAD4	PHD4
Flue Discharge Deflector				
CRFLUEDS001A00	Directs flue gas exhaust 90° upward from current discharge. Designed to allow tighter distances between unit and combustible surfaces. 24" height. AGA certified.	ALL	ALL	ALL
Duct Transitions				
NPDUCFLG002A00	Square to 14" round (one set of two, use with horizontal duct flanges only)	24 -48	24 - 48	24 - 48
Low-Pressure Switch				
CPLPSCTL001A00	Low-Pressure Switch Kit (standard on 24 size)	–	30 - 60	–
Factory Installed on PGS4 and PAD4 "TP" Models				
NAPA00501GR	3/8" spacing dense wire grilles 14"	–	24	–
NAPA00701GR	3/8" spacing dense wire grilles 16"	–	30	–
NAPA01401GR	3/8" spacing dense wire grilles 22"	–	36	–
NAPA00601GR	3/8" spacing dense wire grilles 14"	–	42	–
NAPA01201GR	3/8" spacing dense wire grilles 16"	–	48	–
NAPA01301GR	3/8" spacing dense wire grilles 24"	–	60	–
Factory Installed on PDS4 and PHD4 "TP" Models		PDD4		
NAPA00901GR	3/8" spacing dense wire grilles 18"	24	–	24
NAPA01401GR	3/8" spacing dense wire grilles 22"	30	–	30
NAPA01001GR	3/8" spacing dense wire grilles 18"	36	–	36
NAPA01301GR	3/8" spacing dense wire grilles 24"	42 - 48	–	42 - 48
NAPA01001GR	3/8" spacing dense wire grilles 18"	60	–	60
Electric Heaters – PAD4				
Model	Nominal Capacity (kW)			
CPHEATER052A0*	3.8 / 5.0	–	ALL	
CPHEATER064A0*	3.8 / 5.0	–	ALL	
CPHEATER069A0*	5.4 / 7.2	–	ALL	
CPHEATER070A0*	5.4 / 7.2	–	ALL	
CPHEATER065A0*	7.5 / 10.0	–	24 - 42	
CPHEATER050A0*	7.5 / 10.0	–	ALL	
CPHEATER051A0*	11.3 / 15.0	–	30 - 42	
CPHEATER066A0*	11.3 / 15.0	–	30 - 60	
CPHEATER053A0*	15.0 / 20.0	–	42	
CPHEATER054A0*	15.0 / 20.0	–	42 - 60	
Electric Heaters – PHD4				
Model	Nominal Capacity (kW)			
CPHEATER052A0*	3.8 / 5.0	–		24 - 36
CPHEATER064A0*	3.8 / 5.0	–		ALL
CPHEATER069A0*	5.4 / 7.2	–		24
CPHEATER070A0*	5.4 / 7.2	–		ALL
CPHEATER050A0*	7.5 / 10.0	–		ALL
CPHEATER066A0*	11.3 / 15.0	–		30 - 60
CPHEATER054A0*	15.0 / 20.0	–		42 - 60

*Relay 1184479 is required with this Low-Ambient Control when used in heat pump application.

Specifications subject to change without notice.

Accessories

PAJ4, PHJ4 Single-Phase Models

Model Number	Description	Use With	
		PAJ4	PHJ4
Compressor Start Kit			
CPHSTART002A00	Compressor Start Kit assists compressor start-up by providing additional starting torque on single-phase units only.	ALL	ALL
Crankcase Heater			
CPCRKHTR008A00	Crankcase Heater provides anti-floodback protection for low-load cooling applications (240V)	24 - 36	24 - 36
CPCRKHTR004A00	Crankcase Heater provides anti-floodback protection for low-load cooling applications (240V)	42 - 60	42 - 60
Low-Ambient Kit			
CPLOWAMB001A00	Low-Ambient Kit (Motormaster II Control) allows the use of mechanical cooling system to operate down to 0° F (-18° C) when properly installed	ALL	ALL
Time Guard II			
NRTIMEGD001A00	Automatically prevents the compressor from restarting for at least 4 minutes and 45 seconds after shutdown of the compressor. Not required when a corporate programmable thermostat is applied.	ALL	ALL
Accessory Electric Heaters			
Model	Nominal Capacity (kW)	PAJ4	PHJ4
CPHEATER125A*	3.8 / 5.0 (no circuit breaker)	24 - 60	24 - 48
CPHEATER126A*	3.8 / 5.0	24 - 60	24 - 60
CPHEATER127A*	5.6 / 7.5 (no circuit breaker) Two-Stages	24 - 60	24
CPHEATER128A*	5.6 / 7.5 Two-Stages	24 - 60	24 - 60
CPHEATER129A*	7.5 / 10.0 (no circuit breaker) Two-Stages	24 - 48	NONE
CPHEATER130A*	7.5 / 10.0 Two-Stages	24 - 48	24 - 60
CPHEATER131A*	11.3 / 15.0 Two-Stages	36 - 60	36 - 60
CPHEATER132A*	15.0 / 20.0 Two-Stages	48 - 60	48 - 60

Controls and Indoor Air Quality



TSTAT0201CW

Color Touchscreen Communicating Wall Control



Wi-Fi® Compatible

For use in Single- or Multi-Zone Installations

(Requires a complete Observer® Zoning System and Version 4.02 software or later)

Features

- Supports Observer System communicating equipment multi-stage heating and cooling operation, including modulating gas furnaces (version 4.02 and later) and inverter compressor sections (ODUs; version 5.02 and later). **NOTE:** The TSTAT0101SC wall control DOES NOT support inverter compressor sections.
- TSTAT0201CW features Remote Access via home Wi-Fi network; see www.MyObserverComfort.com for more information and access to iOS and Android mobile apps
- Four-wire (or two-/three-wire depending on the communicating outdoor unit used) installation from each compatible component in the system
- Self configuration with all compatible components in the system
- Simplified programming with options for four daily periods during individual days, all days same, or weekday/weekend schedule; California Title 24 compliant
- Option to use NAXA00101DB Daughter Board for connection with non-communicating system components (single or multi-zone installations)
- Selectable screen backlight brightness, including 30% off
- Supports up to four-stage Heat, two-stage Cool for non-communicating equipment
- Adjustable/resettable filter and service reminders
- High-definition, full-color touchscreen display; QWERTY keyboard for data entry
- Communication with all compatible components in the system
- Enter dealer name and contact info for display during a fault
- Text based diagnostics viewable on screen

Warranty*

- 10-year No Hassle Replacement™ limited warranty
- 10-year parts limited warranty
 - With timely registration, an additional five-year parts limited warranty

* For residential applications only.
See warranty certificate for complete details and restrictions, including warranty coverage for other applications.

Unit Performance Data

Model Number	Description
TSTAT0201CW	Observer® Wireless Wall Control
TSTAT0406	Programmable Thermostat
TSTAT0408	Programmable Thermostat with Humidity Control
NAXA00101DB	Relay Pack Daughter Board
40106750000*	USB Memory Stick Adapter

*Available through the Literature Ordering System

Accessories - TSTAT0201CW

Part Number	Description
NAXA00101DB	Daughter board for use with non-communicating equipment. Converts four-wire signal to conventional multi-wire signals (Y1, Y2, W1, W2, G, O) Note: Can be used in either single- or multiple-zone installations.
NAXA00101WA	Observer® Wireless Access Point for use with TSTAT0201CW model wall control. Provides gateway/router services to an Observer Wi-Fi® network if other Wi-Fi networks are unavailable or unusable. Connects to an existing Ethernet network that provides Internet access. DOES NOT add Wi-Fi capability to the TSTAT0101SC model wall control.
TSTATXXSEN01B	Outdoor Temperature Sensor, use with non-communicating equipment (communicating outdoor equipment factory equipped with OD Temperature Sensor)
TXMBP01	Backplate, medium size. Covers wall spots left when replacing larger thermostats
SYSTXGRPLG10	Communicating Plug, four-wire (DX+, DX-, C, R). Matches connector on control board of communicating indoor and outdoor equipment, 10 pack.
SYSTXIIRRS01	Remote Room Sensor (not required), requires two-wire stat cable, use one or four with Observer control for optional remote temperature sensing (temperatures averaged). (Use ZONE0101RRS as the zone temperature sensor in zoning applications)
Zoning Accessories	
ZONE0101ZP6	Observer Zone Panel supports up to six zones and provides basic relay logic for damper operation and serves as the common connection point for the Observer Zoning System.
ZONE0101RRS	Observer Communicating Room Sensor is a Zone Sensor option for Zones 2 through 6. It provides full setback capabilities (through the Observer wall control interface only) and communicates to Observer Zoning System.
ZONEXXODTS01	Leaving Air Temperature (LAT) Sensor provides temperature readings to the zoning system to optimize performance and to protect the equipment.
ZDAMPRND06INCB	Round Dampers, 6" power open, power closed damper with self-aligning shaft and actuator hub
ZDAMPRND08INCB	Round Dampers, 8" power open, power closed damper with self-aligning shaft and actuator hub
ZDAMPRND10INCB	Round Dampers, 10" power open, power closed damper with self-aligning shaft and actuator hub
ZDAMPRND12INCB	Round Dampers, 12" power open, power closed damper with self-aligning shaft and actuator hub
ZDAMPRND14INCB	Round Dampers, 8" x 14" power open, power closed damper with self-aligning shaft and actuator hub
ZDAMPRND16INCB	Round Dampers, 16" power open, power closed damper with self-aligning shaft and actuator hub
ZDAMPREC08X10B	Rectangular Dampers, 8" x 10" power open, power closed damper with self-aligning shaft and actuator hub
ZDAMPREC08X14B	Rectangular Dampers, 8" x 14" power open, power closed damper with self-aligning shaft and actuator hub
ZDAMPREC08X18B	Rectangular Dampers, 8" x 18" power open, power closed damper with self-aligning shaft and actuator hub
ZDAMPREC08X24B	Rectangular Dampers, 8" x 24" power open, power closed damper with self-aligning shaft and actuator hub
ZDAMPREC10X10B	Rectangular Dampers, 10" x 10" power open, power closed damper with self-aligning shaft and actuator hub
ZDAMPREC10X14B	Rectangular Dampers, 10" x 14" power open, power closed damper with self-aligning shaft and actuator hub
ZDAMPREC10X18B	Rectangular Dampers, 10" x 18" power open, power closed damper with self-aligning shaft and actuator hub
ZDAMPREC10X24B	Rectangular Dampers, 10" x 24" power open, power closed damper with self-aligning shaft and actuator hub
ZDAMPBAR8X14	Rectangular Barometric Bypass, 8" x 14" power open, power closed damper with self-aligning shaft and actuator hub
ZDAMPBAR8X24	Rectangular Barometric Bypass, 8" x 24" power open, power closed damper with self-aligning shaft and actuator hub
ZDAMPACT45DEGR	45° Replacement Actuator for Round Dampers
ZDAMPACT90DEGR	90° Replacement Actuator for Round Dampers

TSTAT0408



TSTAT0408 Features

- Seven-day programming
- Dual Fuel System Management
- Four-wire capability with daughter board
- Four-stage Heat, two-stage Cool
- Auto changeover
- Digital dealer contact info display
- Blue backlit display
- Humidity control
- Option to make "H" terminal energized for dehum or de-energized for dehum

Warranty*

- Five-year parts limited warranty

* For residential applications only.
See warranty certificate for complete details and restrictions,
including warranty coverage for other applications.

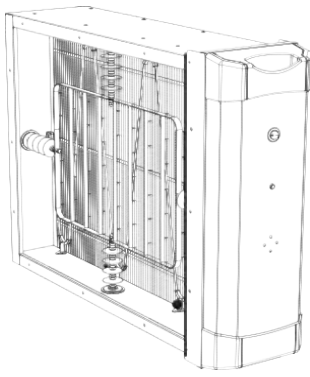

EAICAA Air Purifier

Germicidal Air Purifier

Easier to Sell

- High-efficiency MERV 13
- 96% germicidal/deactivation of human influenza virus, common cold virus and streptococcus bacteria
- Air Purifier is CSA (Canada and US) Listed

Tougher

- Power supply is a highly reliable, dual voltage compatible, state-of-the-art, solid-state device
- Heavy-gauge steel cabinet supports up to 400 lb. when installed beneath a fan coil or furnace

Easy-to-Install and Service

- Five distinct cabinet sizes help to ensure a perfect fit to the bottom and side of most fan coils and furnaces. Includes power cords
- Unit can be installed in a horizontal or vertical position, which makes it equally adaptable to horizontal, downflow, or standard upflow applications

Warranty*

- Five-year parts limited warranty
 - With timely registration, an additional five-year parts limited warranty

* For residential applications only. See warranty certificate for complete details and restrictions, including warranty coverage for other applications.

The Air Purifier is designed for use in the return air duct of a forced air heating, cooling, and ventilation system. It combines superior filtration efficiency, MERV 13, with pathogen-killing technology to deliver maximum air purification.

The Air Purifier is designed to require minimal maintenance. Maintenance is limited to the replacement of the air purification cartridge and inspection/brush cleaning of the ionization array. Frequency of air purifier cartridge replacement and cleaning of the ionization array may vary depending on ductwork design and local environmental conditions.

Unit Performance Data

Model Number	Dimensions H x W x D Inches (mm)	Shipping Weight Lbs (Kg)
EAICAXX1620	18.48 x 7.25 x 24.68 (469 x 184 x 627)	30 (14)
EAICAXX2020	22.18 x 7.25 x 24.68 (563 x 184 x 627)	27 (12)
EAICAXX2420	25.68 x 7.25 x 24.68 (652 x 184 x 627)	28 (12)
EAICAXX1625	18.48 x 7.25 x 27.68 (469 x 184 x 703)	32 (15)
EAICAXX2025	22.18 x 7.25 x 27.68 (563 x 184 x 703)	29 (13)

Accessories

EAICA Air Purifier

Accessory Part Number	Description	EAICAXX				
		1625	2025	1620	2020	2420
KIT140000*	Filter Enhancement	X	-	-	-	-
KIT141000*	Filter Enhancement	-	X	-	-	-
KIT142000*	Filter Enhancement	-	-	X	-	-
KIT143000*	Filter Enhancement	-	-	-	X	-
KIT144000*	Filter Enhancement	-	-	-	-	X
KIT153000*	Front Door including power supply	X	-	X	-	-
KIT154000*	Front Door including power supply	-	X	-	X	-
KIT155000*	Front Door including power supply	-	-	-	-	X
KIT170000*	Front Screen	X	-	-	-	-
KIT171000*	Front Screen	-	X	-	-	-
KIT172000*	Front Screen	-	-	X	-	-
KIT173000*	Front Screen	-	-	-	X	-
KIT174000*	Front Screen	-	-	-	-	X
EAICXCAR1625A02	Replacement Filter (two pack)	X	-	-	-	-
EAICXCAR2025A02	Replacement Filter (two pack)	-	X	-	-	-
EAICXCAR1620A02	Replacement Filter (two pack)	-	-	X	-	-
EAICXCAR2020A02	Replacement Filter (two pack)	-	-	-	X	-
EAICXCAR2420A02	Replacement Filter (two pack)	-	-	-	-	X
Exceptions						
EAICAXX1625 and EAICAXX2025 are standard (shipped) with Flow Sensor for Furnaces (if applied with fan coil, KIT160000 – Flow Sensor and KFAPS0110KIT – Fuse Kit are required)						
KIT160000*	Flow Sensor (required if no EAC terminals)	X	X	Std	Std	Std
KFAPS0110KIT	240 VAC – Fuse Kit (required if installed with fan coil)	X	X	Std	Std	Std
EAICAXX1620, EAICAXX2020 and EAICAXX2420 are standard (shipped) with Flow Sensor for Fan Coils (if applied with furnace, KIT161000 is required)						
KIT161000*	Flow Sensor Jumper/Bypass (if installed with furnace with EAC terminals)	Std	Std	X	X	X

* Order from FAST parts

X = Accessory

S = Standard

Geothermal



HP

R410-A Geothermal Package Heat Pump

2 – 6 Ton



Easier to Sell

- 3.5 - 4.0 COP, 15.5 - 24.5 EER (Closed Loop)
- 4.0 - 4.6 COP, 19.6 - 30.0 EER (Open Loop)
- 2" filter, MERV 8
- Unit available in vertical upflow, downflow and horizontal
- Compressor blanket
- Fully insulated cabinet with closed cell foam
- Optional supplemental domestic water heating
- Optional cupro-nickel heat exchanger for open loop applications

Warranty*

- Five-year No Hassle Replacement™ limited warranty
- Five-year labor limited warranty
 - With timely registration, an additional five-year labor limited warranty
- 10-year parts limited warranty (including compressor)

* For residential applications only (owner occupied for No Hassle warranty).
See warranty certificate for complete details and restrictions, including warranty coverage for other applications.

Tougher

- Two-stage scroll compressor
- Variable-speed ECM blower motor
- Tin-plated copper tubing in air coil

Easier to Install and Service

- Compatible with many three-stage heat, two-stage cooling programmable thermostats
- Microprocessor control



Qualifying models only.

Unit Performance Data

Model Number	Size (tons)	Nominal Btu/hr	Min. Circuit Ampacity	Max. Fuse or Breaker	Dimensions H x W x D (sq) in.
HPO24CBLCDDET1XX1	2	24,000	17.4	25	47-1/4 X 21-1/2 X 26
HPO24CBLCXET1XX1	2	24,000	17.4	25	47-1/4 X 21-1/2 X 26
HPO24CBLNDET1XX1	2	24,000	17.4	25	47-1/4 X 21-1/2 X 26
HPO24CBLNXET1XX1	2	24,000	17.4	25	47-1/4 X 21-1/2 X 26
HPO24CBRCDET1XX1	2	24,000	17.4	25	47-1/4 X 21-1/2 X 26
HPO24CBRCXET1XX1	2	24,000	17.4	25	47-1/4 X 21-1/2 X 26
HPO24CBRNDET1XX1	2	24,000	17.4	25	47-1/4 X 21-1/2 X 26
HPO24CBRNXET1XX1	2	24,000	17.4	25	47-1/4 X 21-1/2 X 26
HPO24HELCDDET1XX1	2	24,000	17.4	25	21-3/4 X 26 X 54-1/2
HPO24HELXET1XX1	2	24,000	17.4	25	21-3/4 X 26 X 54-1/2
HPO24HELNDET1XX1	2	24,000	17.4	25	21-3/4 X 26 X 54-1/2
HPO24HELNXET1XX1	2	24,000	17.4	25	21-3/4 X 26 X 54-1/2
HPO24HERCDDET1XX1	2	24,000	17.4	25	21-3/4 X 26 X 54-1/2
HPO24HERCXET1XX1	2	24,000	17.4	25	21-3/4 X 26 X 54-1/2
HPO24HERNDET1XX1	2	24,000	17.4	25	21-3/4 X 26 X 54-1/2
HPO24HERNXET1XX1	2	24,000	17.4	25	21-3/4 X 26 X 54-1/2
HPO24HSLCDDET1XX1	2	24,000	17.4	25	21-3/4 X 26 X 54-1/2
HPO24HSLCXET1XX1	2	24,000	17.4	25	21-3/4 X 26 X 54-1/2
HPO24HSLNDET1XX1	2	24,000	17.4	25	21-3/4 X 26 X 54-1/2
HPO24HSLNXET1XX1	2	24,000	17.4	25	21-3/4 X 26 X 54-1/2
HPO24HSRCDDET1XX1	2	24,000	17.4	25	21-3/4 X 26 X 54-1/2
HPO24HSRCXET1XX1	2	24,000	17.4	25	21-3/4 X 26 X 54-1/2
HPO24HSRNDET1XX1	2	24,000	17.4	25	21-3/4 X 26 X 54-1/2
HPO24HSRNXET1XX1	2	24,000	17.4	25	21-3/4 X 26 X 54-1/2
HPO24VTLCDDET1XX1	2	24,000	17.4	25	47-1/4 X 21-1/2 X 26
HPO24VTLXET1XX1	2	24,000	17.4	25	47-1/4 X 21-1/2 X 26
HPO24VTLNDET1XX1	2	24,000	17.4	25	47-1/4 X 21-1/2 X 26
HPO24VTLNXET1XX1	2	24,000	17.4	25	47-1/4 X 21-1/2 X 26

Unit Performance Data



Model Number	Size (tons)	Nominal Btu/hr	Min. Circuit Ampacity	Max. Fuse or Breaker	Dimensions H x W x D (sq) in.
HPO24VTRCDET1XX1	2	24,000	17.4	25	47-1/4 X 21-1/2 X 26
HPO24VTRCXET1XX1	2	24,000	17.4	25	47-1/4 X 21-1/2 X 26
HPO24VTRNDET1XX1	2	24,000	17.4	25	47-1/4 X 21-1/2 X 26
HPO24VTRNXET1XX1	2	24,000	17.4	25	47-1/4 X 21-1/2 X 26
HPO36CBLCDET1XX1	3	36,000	23.4	35	47-1/4 X 21-1/2 X 26
HPO36CBLCXET1XX1	3	36,000	23.4	35	47-1/4 X 21-1/2 X 26
HPO36CBLNDET1XX1	3	36,000	23.4	35	47-1/4 X 21-1/2 X 26
HPO36CBLNXET1XX1	3	36,000	23.4	35	47-1/4 X 21-1/2 X 26
HPO36CBRCDET1XX1	3	36,000	23.4	35	47-1/4 X 21-1/2 X 26
HPO36CBRCXET1XX1	3	36,000	23.4	35	47-1/4 X 21-1/2 X 26
HPO36CBRNDET1XX1	3	36,000	23.4	35	47-1/4 X 21-1/2 X 26
HPO36CBRNXET1XX1	3	36,000	23.4	35	47-1/4 X 21-1/2 X 26
HPO36HELCDT1XX1	3	36,000	23.4	35	21-3/4 X 26 X 54-1/2
HPO36HELCDT1XX1	3	36,000	23.4	35	21-3/4 X 26 X 54-1/2
HPO36HELNDT1XX1	3	36,000	23.4	35	21-3/4 X 26 X 54-1/2
HPO36HELNDT1XX1	3	36,000	23.4	35	21-3/4 X 26 X 54-1/2
HPO36HELNXET1XX1	3	36,000	23.4	35	21-3/4 X 26 X 54-1/2
HPO36HERCDT1XX1	3	36,000	23.4	35	21-3/4 X 26 X 54-1/2
HPO36HERCDT1XX1	3	36,000	23.4	35	21-3/4 X 26 X 54-1/2
HPO36HERCXET1XX1	3	36,000	23.4	35	21-3/4 X 26 X 54-1/2
HPO36HERNDT1XX1	3	36,000	23.4	35	21-3/4 X 26 X 54-1/2
HPO36HERNDT1XX1	3	36,000	23.4	35	21-3/4 X 26 X 54-1/2
HPO36HERNXET1XX1	3	36,000	23.4	35	21-3/4 X 26 X 54-1/2
HPO36HSLCDT1XX1	3	36,000	23.4	35	21-3/4 X 26 X 54-1/2
HPO36HSLCDT1XX1	3	36,000	23.4	35	21-3/4 X 26 X 54-1/2
HPO36HSLCXET1XX1	3	36,000	23.4	35	21-3/4 X 26 X 54-1/2
HPO36HSLNDT1XX1	3	36,000	23.4	35	21-3/4 X 26 X 54-1/2
HPO36HSLNDT1XX1	3	36,000	23.4	35	21-3/4 X 26 X 54-1/2
HPO36HSLNXET1XX1	3	36,000	23.4	35	21-3/4 X 26 X 54-1/2
HPO36HSRCDT1XX1	3	36,000	23.4	35	21-3/4 X 26 X 54-1/2
HPO36HSRCDT1XX1	3	36,000	23.4	35	21-3/4 X 26 X 54-1/2
HPO36HSRCXET1XX1	3	36,000	23.4	35	21-3/4 X 26 X 54-1/2
HPO36HSRNDT1XX1	3	36,000	23.4	35	21-3/4 X 26 X 54-1/2
HPO36HSRNDT1XX1	3	36,000	23.4	35	21-3/4 X 26 X 54-1/2
HPO36HSRNXET1XX1	3	36,000	23.4	35	21-3/4 X 26 X 54-1/2
HPO36VTLCDT1XX1	3	36,000	23.4	35	47-1/4 X 21-1/2 X 26
HPO36VTLCDT1XX1	3	36,000	23.4	35	47-1/4 X 21-1/2 X 26
HPO36VTLCXET1XX1	3	36,000	23.4	35	47-1/4 X 21-1/2 X 26
HPO36VTLNDT1XX1	3	36,000	23.4	35	47-1/4 X 21-1/2 X 26
HPO36VTLNDT1XX1	3	36,000	23.4	35	47-1/4 X 21-1/2 X 26
HPO36VTLNXET1XX1	3	36,000	23.4	35	47-1/4 X 21-1/2 X 26
HPO36VTRCDET1XX1	3	36,000	23.4	35	47-1/4 X 21-1/2 X 26
HPO36VTRCDET1XX1	3	36,000	23.4	35	47-1/4 X 21-1/2 X 26
HPO36VTRCXET1XX1	3	36,000	23.4	35	47-1/4 X 21-1/2 X 26
HPO36VTRNDET1XX1	3	36,000	23.4	35	47-1/4 X 21-1/2 X 26
HPO36VTRNDET1XX1	3	36,000	23.4	35	47-1/4 X 21-1/2 X 26
HPO36VTRNXET1XX1	3	36,000	23.4	35	47-1/4 X 21-1/2 X 26
HPO48CBLCDET1XX1	4	48,000	33.3	50	47-1/4 X 24 X 32-3/4
HPO48CBLCDET1XX1	4	48,000	33.3	50	47-1/4 X 24 X 32-3/4
HPO48CBLCXET1XX1	4	48,000	33.3	50	47-1/4 X 24 X 32-3/4
HPO48CBLNDET1XX1	4	48,000	33.3	50	47-1/4 X 24 X 32-3/4
HPO48CBLNDET1XX1	4	48,000	33.3	50	47-1/4 X 24 X 32-3/4
HPO48CBLNXET1XX1	4	48,000	33.3	50	47-1/4 X 24 X 32-3/4
HPO48CBRCDET1XX1	4	48,000	33.3	50	47-1/4 X 24 X 32-3/4
HPO48CBRCDET1XX1	4	48,000	33.3	50	47-1/4 X 24 X 32-3/4
HPO48CBRCXET1XX1	4	48,000	33.3	50	47-1/4 X 24 X 32-3/4
HPO48CBRNDET1XX1	4	48,000	33.3	50	47-1/4 X 24 X 32-3/4
HPO48CBRNDET1XX1	4	48,000	33.3	50	47-1/4 X 24 X 32-3/4
HPO48CBRNXET1XX1	4	48,000	33.3	50	47-1/4 X 24 X 32-3/4

HP

Model Number	Size (tons)	Nominal Btu/hr	Min. Circuit Ampacity	Max. Fuse or Breaker	Dimensions H x W x D (sq) in.
HP048HELCDDET1XX1	4	48,000	33.3	50	21-3/4 X 30 X 68
HP048HELXCET1XX1	4	48,000	33.3	50	21-3/4 X 30 X 68
HP048HELNDDET1XX1	4	48,000	33.3	50	21-3/4 X 30 X 68
HP048HELNXET1XX1	4	48,000	33.3	50	21-3/4 X 30 X 68
HP048HERCDET1XX1	4	48,000	33.3	50	21-3/4 X 30 X 68
HP048HERCXET1XX1	4	48,000	33.3	50	21-3/4 X 30 X 68
HP048HERNDDET1XX1	4	48,000	33.3	50	21-3/4 X 30 X 68
HP048HERNXET1XX1	4	48,000	33.3	50	21-3/4 X 30 X 68
HP048HSLCDET1XX1	4	48,000	33.3	50	21-3/4 X 30 X 68
HP048HSLXCET1XX1	4	48,000	33.3	50	21-3/4 X 30 X 68
HP048HSLNDDET1XX1	4	48,000	33.3	50	21-3/4 X 30 X 68
HP048HSLNXET1XX1	4	48,000	33.3	50	21-3/4 X 30 X 68
HP048HSRCDET1XX1	4	48,000	33.3	50	21-3/4 X 30 X 68
HP048HSRCXET1XX1	4	48,000	33.3	50	21-3/4 X 30 X 68
HP048HSRNDDET1XX1	4	48,000	33.3	50	21-3/4 X 30 X 68
HP048HSRNXET1XX1	4	48,000	33.3	50	21-3/4 X 30 X 68
HP048VTLCDDET1XX1	4	48,000	33.3	50	47-1/4 X 24 X 32-3/4
HP048VTLXCET1XX1	4	48,000	33.3	50	47-1/4 X 24 X 32-3/4
HP048VTLNDDET1XX1	4	48,000	33.3	50	47-1/4 X 24 X 32-3/4
HP048VTLNXET1XX1	4	48,000	33.3	50	47-1/4 X 24 X 32-3/4
HP048VTRCDET1XX1	4	48,000	33.3	50	47-1/4 X 24 X 32-3/4
HP048VTRCXET1XX1	4	48,000	33.3	50	47-1/4 X 24 X 32-3/4
HP048VTRNDDET1XX1	4	48,000	33.3	50	47-1/4 X 24 X 32-3/4
HP048VTRNXET1XX1	4	48,000	33.3	50	47-1/4 X 24 X 32-3/4
HP060CBLCDDET1XX1	5	60,000	43.0	70	51-1/4 X 26 X 32-1/4
HP060CBLXCET1XX1	5	60,000	43.0	70	51-1/4 X 26 X 32-1/4
HP060CBLNDDET1XX1	5	60,000	43.0	70	51-1/4 X 26 X 32-1/4
HP060CBLNXET1XX1	5	60,000	43.0	70	51-1/4 X 26 X 32-1/4
HP060CBRCDET1XX1	5	60,000	43.0	70	51-1/4 X 26 X 32-1/4
HP060CBRCXET1XX1	5	60,000	43.0	70	51-1/4 X 26 X 32-1/4
HP060CBRNDDET1XX1	5	60,000	43.0	70	51-1/4 X 26 X 32-1/4
HP060CBRNXET1XX1	5	60,000	43.0	70	51-1/4 X 26 X 32-1/4
HP060HELCDDET1XX1	5	60,000	43.0	70	21-3/4 X 30 X 68
HP060HELXCET1XX1	5	60,000	43.0	70	21-3/4 X 30 X 68
HP060HELNDDET1XX1	5	60,000	43.0	70	21-3/4 X 30 X 68
HP060HELNXET1XX1	5	60,000	43.0	70	21-3/4 X 30 X 68
HP060HERCDET1XX1	5	60,000	43.0	70	21-3/4 X 30 X 68
HP060HERCXET1XX1	5	60,000	43.0	70	21-3/4 X 30 X 68
HP060HERNDDET1XX1	5	60,000	43.0	70	21-3/4 X 30 X 68
HP060HERNXET1XX1	5	60,000	43.0	70	21-3/4 X 30 X 68
HP060HSLCDET1XX1	5	60,000	43.0	70	21-3/4 X 30 X 68
HP060HSLXCET1XX1	5	60,000	43.0	70	21-3/4 X 30 X 68
HP060HSLNDDET1XX1	5	60,000	43.0	70	21-3/4 X 30 X 68
HP060HSLNXET1XX1	5	60,000	43.0	70	21-3/4 X 30 X 68

Model Number	Size (tons)	Nominal Btu/hr	Min. Circuit Ampacity	Max. Fuse or Breaker	Dimensions H x W x D (sq) in.
HP060HSRCDET1XX1	5	60,000	43.0	70	21-3/4 X 30 X 68
HP060HSRCXET1XX1	5	60,000	43.0	70	21-3/4 X 30 X 68
HP060HSRNDDET1XX1	5	60,000	43.0	70	21-3/4 X 30 X 68
HP060HSRNXET1XX1	5	60,000	43.0	70	21-3/4 X 30 X 68
HP060VTLCDDET1XX1	5	60,000	43.0	70	51-1/4 X 26 X 32-1/4
HP060VTLCXET1XX1	5	60,000	43.0	70	51-1/4 X 26 X 32-1/4
HP060VTLNDET1XX1	5	60,000	43.0	70	51-1/4 X 26 X 32-1/4
HP060VTLNXET1XX1	5	60,000	43.0	70	51-1/4 X 26 X 32-1/4
HP060VTRCDET1XX1	5	60,000	43.0	70	51-1/4 X 26 X 32-1/4
HP060VTRCXET1XX1	5	60,000	43.0	70	51-1/4 X 26 X 32-1/4
HP060VTRNDET1XX1	5	60,000	43.0	70	51-1/4 X 26 X 32-1/4
HP060VTRNXET1XX1	5	60,000	43.0	70	51-1/4 X 26 X 32-1/4
HP072CBLCDDET1XX1	6	72,000	46.2	70	58-1/4 X 26 X 33-1/4
HP072CBLCXET1XX1	6	72,000	46.2	70	58-1/4 X 26 X 33-1/4
HP072CBLNDET1XX1	6	72,000	46.2	70	58-1/4 X 26 X 33-1/4
HP072CBLNXET1XX1	6	72,000	46.2	70	58-1/4 X 26 X 33-1/4
HP072CBRCDET1XX1	6	72,000	46.2	70	58-1/4 X 26 X 33-1/4
HP072CBRCXET1XX1	6	72,000	46.2	70	58-1/4 X 26 X 33-1/4
HP072CBRNDDET1XX1	6	72,000	46.2	70	58-1/4 X 26 X 33-1/4
HP072CBRNXET1XX1	6	72,000	46.2	70	58-1/4 X 26 X 33-1/4
HP072HELCDDET1XX1	6	72,000	46.2	70	21-3/4 X 30 X 78
HP072HELCTXET1XX1	6	72,000	46.2	70	21-3/4 X 30 X 78
HP072HELNDET1XX1	6	72,000	46.2	70	21-3/4 X 30 X 78
HP072HELNXET1XX1	6	72,000	46.2	70	21-3/4 X 30 X 78
HP072HERCDDET1XX1	6	72,000	46.2	70	21-3/4 X 30 X 78
HP072HERCTXET1XX1	6	72,000	46.2	70	21-3/4 X 30 X 78
HP072HERNDET1XX1	6	72,000	46.2	70	21-3/4 X 30 X 78
HP072HERNXET1XX1	6	72,000	46.2	70	21-3/4 X 30 X 78
HP072HSLCDDET1XX1	6	72,000	46.2	70	21-3/4 X 30 X 78
HP072HSLCXET1XX1	6	72,000	46.2	70	21-3/4 X 30 X 78
HP072HSLNDET1XX1	6	72,000	46.2	70	21-3/4 X 30 X 78
HP072HSLNXET1XX1	6	72,000	46.2	70	21-3/4 X 30 X 78
HP072HSRCDET1XX1	6	72,000	46.2	70	21-3/4 X 30 X 78
HP072HSRCXET1XX1	6	72,000	46.2	70	21-3/4 X 30 X 78
HP072HSRNDDET1XX1	6	72,000	46.2	70	21-3/4 X 30 X 78
HP072HSRNXET1XX1	6	72,000	46.2	70	21-3/4 X 30 X 78
HP072VTLCDDET1XX1	6	72,000	46.2	70	58-1/4 X 26 X 33-1/4
HP072VTLCXET1XX1	6	72,000	46.2	70	58-1/4 X 26 X 33-1/4
HP072VTLNDET1XX1	6	72,000	46.2	70	58-1/4 X 26 X 33-1/4
HP072VTLNXET1XX1	6	72,000	46.2	70	58-1/4 X 26 X 33-1/4
HP072VTRCDET1XX1	6	72,000	46.2	70	58-1/4 X 26 X 33-1/4
HP072VTRCXET1XX1	6	72,000	46.2	70	58-1/4 X 26 X 33-1/4
HP072VTRNDET1XX1	6	72,000	46.2	70	58-1/4 X 26 X 33-1/4
HP072VTRNXET1XX1	6	72,000	46.2	70	58-1/4 X 26 X 33-1/4

HB

R410-A Geothermal Package Heat Pump 1.5 – 5 Ton



Easier to Sell

- 3.7 - 4.3 COP, 18.5 - 21.7 EER (Closed Loop)
- 4.3 - 5.2 COP, 22.7 - 28.1 EER (Open Loop)
- 2" filter, MERV 8
- Unit available in vertical, upflow and horizontal
- Fully insulated cabinet with closed cell foam
- Optional supplemental domestic water heating

Tougher

- Single-stage scroll compressor (rotary size 018)
- Multi-speed constant torque blower motor
- Tin-plated copper tubing in air coil



Qualifying models only.

Easier to Install and Service

- Compatible with many three-stage heat, single-stage cooling programmable thermostats
- Microprocessor control

Warranty*

- Five-year parts and labor limited warranty (including compressor)
 - With timely registration, an additional five-year parts limited warranty (including compressor)

* For residential applications only.

See warranty certificate for complete details and restrictions, including warranty coverage for other applications.

Unit Performance Data

Model Number	Size (tons)	Nominal Btu/hr	Min. Circuit Ampacity	Max. Fuse or Breaker	Dimensions H x W x D (sq) in.
HB018HELXCXC1XX1	1.5	18,000	12.1	15	19-3/4 X 22-1/4 X 45-1/4
HB018HELNXCC1XX1	1.5	18,000	12.1	15	19-3/4 X 22-1/4 X 45-1/4
HB018HERXCXC1XX1	1.5	18,000	12.1	15	19-3/4 X 22-1/4 X 45-1/4
HB018HERNXCC1XX1	1.5	18,000	12.1	15	19-3/4 X 22-1/4 X 45-1/4
HB018HSLXCXC1XX1	1.5	18,000	12.1	15	19-3/4 X 22-1/4 X 45-1/4
HB018HSLNXCC1XX1	1.5	18,000	12.1	15	19-3/4 X 22-1/4 X 45-1/4
HB018HSRCXC1XX1	1.5	18,000	12.1	15	19-3/4 X 22-1/4 X 45-1/4
HB018HSRNXC1XX1	1.5	18,000	12.1	15	19-3/4 X 22-1/4 X 45-1/4
HB018VTLXCXC1XX1	1.5	18,000	12.1	15	39-1/4 X 21-3/4 X 21-3/4
HB018VTLNXCC1XX1	1.5	18,000	12.1	15	39-1/4 X 21-3/4 X 21-3/4
HB018VTRXCXC1XX1	1.5	18,000	12.1	15	39-1/4 X 21-3/4 X 21-3/4
HB018VTRNXCC1XX1	1.5	18,000	12.1	15	39-1/4 X 21-3/4 X 21-3/4
HB024HELCDCC1XX1	2	24,000	19.7	30	22 X 26-1/4 X 54-3/4
HB024HELXCXC1XX1	2	24,000	19.7	30	22 X 26-1/4 X 54-3/4
HB024HELNDCC1XX1	2	24,000	19.7	30	22 X 26-1/4 X 54-3/4
HB024HELNXCC1XX1	2	24,000	19.7	30	22 X 26-1/4 X 54-3/4
HB024HERCDCC1XX1	2	24,000	19.7	30	22 X 26-1/4 X 54-3/4
HB024HERXCXC1XX1	2	24,000	19.7	30	22 X 26-1/4 X 54-3/4
HB024HERNDCC1XX1	2	24,000	19.7	30	22 X 26-1/4 X 54-3/4
HB024HERNXCC1XX1	2	24,000	19.7	30	22 X 26-1/4 X 54-3/4
HB024HSLCDCC1XX1	2	24,000	19.7	30	22 X 26-1/4 X 54-3/4
HB024HSLXCXC1XX1	2	24,000	19.7	30	22 X 26-1/4 X 54-3/4
HB024HSLNDCC1XX1	2	24,000	19.7	30	22 X 26-1/4 X 54-3/4
HB024HSLNXCC1XX1	2	24,000	19.7	30	22 X 26-1/4 X 54-3/4
HB024HSRCDCC1XX1	2	24,000	19.7	30	22 X 26-1/4 X 54-3/4

Unit Performance Data

Model Number	Size (tons)	Nominal Btu/hr	Min. Circuit Ampacity	Max. Fuse or Breaker	Dimensions H x W x D (sq) in.
HB024HSRCXCC1XX1	2	24,000	19.7	30	22 x 26-1/4 x 54-3/4
HB024HSRNDCC1XX1	2	24,000	19.7	30	22 x 26-1/4 x 54-3/4
HB024HSRNXC1XX1	2	24,000	19.7	30	22 x 26-1/4 x 54-3/4
HB024VTLCDCC1XX1	2	24,000	19.7	30	47-1/4 x 21-3/4 x 26-1/4
HB024VTLXCXCC1XX1	2	24,000	19.7	30	47-1/4 x 21-3/4 x 26-1/4
HB024VTLNDCC1XX1	2	24,000	19.7	30	47-1/4 x 21-3/4 x 26-1/4
HB024VTLNXCC1XX1	2	24,000	19.7	30	47-1/4 x 21-3/4 x 26-1/4
HB024VTRCDCC1XX1	2	24,000	19.7	30	47-1/4 x 21-3/4 x 26-1/4
HB024VTRXCXCC1XX1	2	24,000	19.7	30	47-1/4 x 21-3/4 x 26-1/4
HB024VTRNDCC1XX1	2	24,000	19.7	30	47-1/4 x 21-3/4 x 26-1/4
HB024VTRNXCC1XX1	2	24,000	19.7	30	47-1/4 x 21-3/4 x 26-1/4
HB030HELCDCC1XX1	2.5	30,000	20.1	30	22 x 30-1/4 x 68-1/4
HB030HELXCXCC1XX1	2.5	30,000	20.1	30	22 x 30-1/4 x 68-1/4
HB030HELNDCC1XX1	2.5	30,000	20.1	30	22 x 30-1/4 x 68-1/4
HB030HELNXCC1XX1	2.5	30,000	20.1	30	22 x 30-1/4 x 68-1/4
HB030HERCDCC1XX1	2.5	30,000	20.1	30	22 x 30-1/4 x 68-1/4
HB030HERXCXCC1XX1	2.5	30,000	20.1	30	22 x 30-1/4 x 68-1/4
HB030HERNDCC1XX1	2.5	30,000	20.1	30	22 x 30-1/4 x 68-1/4
HB030HERNXCC1XX1	2.5	30,000	20.1	30	22 x 30-1/4 x 68-1/4
HB030HSLCDCC1XX1	2.5	30,000	20.1	30	22 x 30-1/4 x 68-1/4
HB030HSLXCXCC1XX1	2.5	30,000	20.1	30	22 x 30-1/4 x 68-1/4
HB030HSLNDCC1XX1	2.5	30,000	20.1	30	22 x 30-1/4 x 68-1/4
HB030HSLNDCC1XX1	2.5	30,000	20.1	30	22 x 30-1/4 x 68-1/4
HB030HSLNXCC1XX1	2.5	30,000	20.1	30	22 x 30-1/4 x 68-1/4
HB030HSRCDCC1XX1	2.5	30,000	20.1	30	22 x 30-1/4 x 68-1/4
HB030HSRCXCC1XX1	2.5	30,000	20.1	30	22 x 30-1/4 x 68-1/4
HB030HSRNDCC1XX1	2.5	30,000	20.1	30	22 x 30-1/4 x 68-1/4
HB030HSRNXC1XX1	2.5	30,000	20.1	30	22 x 30-1/4 x 68-1/4
HB030VTLCDCC1XX1	2.5	30,000	20.1	30	47-1/4 x 24-1/4 x 33-1/2
HB030VTLXCXCC1XX1	2.5	30,000	20.1	30	47-1/4 x 24-1/4 x 33-1/2
HB030VTLNDCC1XX1	2.5	30,000	20.1	30	47-1/4 x 24-1/4 x 33-1/2
HB030VTLNXCC1XX1	2.5	30,000	20.1	30	47-1/4 x 24-1/4 x 33-1/2
HB030VTRCDCC1XX1	2.5	30,000	20.1	30	47-1/4 x 24-1/4 x 33-1/2
HB030VTRXCXCC1XX1	2.5	30,000	20.1	30	47-1/4 x 24-1/4 x 33-1/2
HB030VTRNDCC1XX1	2.5	30,000	20.1	30	47-1/4 x 24-1/4 x 33-1/2
HB030VTRNXCC1XX1	2.5	30,000	20.1	30	47-1/4 x 24-1/4 x 33-1/2
HB036HELXCXCC1XX1	3	36,000	26.0	40	22 X 30-1/4 X 68-1/4
HB036HELXCXCC1XX1	3	36,000	26.0	40	22 X 30-1/4 X 68-1/4
HB036HELNDCC1XX1	3	36,000	26.0	40	22 X 30-1/4 X 68-1/4
HB036HELNXCC1XX1	3	36,000	26.0	40	22 X 30-1/4 X 68-1/4
HB036HERCDCC1XX1	3	36,000	26.0	40	22 X 30-1/4 X 68-1/4
HB036HERXCXCC1XX1	3	36,000	26.0	40	22 X 30-1/4 X 68-1/4
HB036HERNDCC1XX1	3	36,000	26.0	40	22 X 30-1/4 X 68-1/4
HB036HERNXCC1XX1	3	36,000	26.0	40	22 X 30-1/4 X 68-1/4

HB Unit Performance Data

Model Number	Size (tons)	Nominal Btu/hr	Min. Circuit Ampacity	Max. Fuse or Breaker	Dimensions H x W x D (sq) in.
HB036HSLCDDC1XX1	3	36,000	26.0	40	22 X 30-1/4 X 68-1/4
HB036HSLCXCC1XX1	3	36,000	26.0	40	22 X 30-1/4 X 68-1/4
HB036HSLNDCC1XX1	3	36,000	26.0	40	22 X 30-1/4 X 68-1/4
HB036HSLNXCC1XX1	3	36,000	26.0	40	22 X 30-1/4 X 68-1/4
HB036HSRCDCC1XX1	3	36,000	26.0	40	22 X 30-1/4 X 68-1/4
HB036HSRCXCC1XX1	3	36,000	26.0	40	22 X 30-1/4 X 68-1/4
HB036HSRNDCC1XX1	3	36,000	26.0	40	22 X 30-1/4 X 68-1/4
HB036HSRNXCC1XX1	3	36,000	26.0	40	22 X 30-1/4 X 68-1/4
HB036VTLCDCC1XX1	3	36,000	26.0	40	47-1/4 X 24-1/4 X 33-1/2
HB036VTLXCXCC1XX1	3	36,000	26.0	40	47-1/4 X 24-1/4 X 33-1/2
HB036VTLNDCC1XX1	3	36,000	26.0	40	47-1/4 X 24-1/4 X 33-1/2
HB036VTLNXCC1XX1	3	36,000	26.0	40	47-1/4 X 24-1/4 X 33-1/2
HB036VTRCDCC1XX1	3	36,000	26.0	40	47-1/4 X 24-1/4 X 33-1/2
HB036VTRCXCC1XX1	3	36,000	26.0	40	47-1/4 X 24-1/4 X 33-1/2
HB036VTRNDCC1XX1	3	36,000	26.0	40	47-1/4 X 24-1/4 X 33-1/2
HB036VTRNXCC1XX1	3	36,000	26.0	40	47-1/4 X 24-1/4 X 33-1/2
HB042HELCDCC1XX1	3.5	42,000	26.9	40	22 X 30-1/4 X 79
HB042HELXCXCC1XX1	3.5	42,000	26.9	40	22 X 30-1/4 X 79
HB042HELNDCC1XX1	3.5	42,000	26.9	40	22 X 30-1/4 X 79
HB042HELNXCC1XX1	3.5	42,000	26.9	40	22 X 30-1/4 X 79
HB042HERCDCC1XX1	3.5	42,000	26.9	40	22 X 30-1/4 X 79
HB042HERCXCC1XX1	3.5	42,000	26.9	40	22 X 30-1/4 X 79
HB042HERNDCC1XX1	3.5	42,000	26.9	40	22 X 30-1/4 X 79
HB042HERNXCC1XX1	3.5	42,000	26.9	40	22 X 30-1/4 X 79
HB042HSLCDCC1XX1	3.5	42,000	26.9	40	22 X 30-1/4 X 79
HB042HSLCXCC1XX1	3.5	42,000	26.9	40	22 X 30-1/4 X 79
HB042HSLNDCC1XX1	3.5	42,000	26.9	40	22 X 30-1/4 X 79
HB042HSLNXCC1XX1	3.5	42,000	26.9	40	22 X 30-1/4 X 79
HB042HSRCDCC1XX1	3.5	42,000	26.9	40	22 X 30-1/4 X 79
HB042HSRCXCC1XX1	3.5	42,000	26.9	40	22 X 30-1/4 X 79
HB042HSRNDCC1XX1	3.5	42,000	26.9	40	22 X 30-1/4 X 79
HB042HSRNXCC1XX1	3.5	42,000	26.9	40	22 X 30-1/4 X 79
HB042VTLCDCC1XX1	3.5	42,000	26.9	40	58-1/4 X 26-1/4 X 33-1/2
HB042VTLXCXCC1XX1	3.5	42,000	26.9	40	58-1/4 X 26-1/4 X 33-1/2
HB042VTLNDCC1XX1	3.5	42,000	26.9	40	58-1/4 X 26-1/4 X 33-1/2
HB042VTLNXCC1XX1	3.5	42,000	26.9	40	58-1/4 X 26-1/4 X 33-1/2
HB042VTRCDCC1XX1	3.5	42,000	26.9	40	58-1/4 X 26-1/4 X 33-1/2
HB042VTRCXCC1XX1	3.5	42,000	26.9	40	58-1/4 X 26-1/4 X 33-1/2
HB042VTRNDCC1XX1	3.5	42,000	26.9	40	58-1/4 X 26-1/4 X 33-1/2
HB042VTRNXCC1XX1	3.5	42,000	26.9	40	58-1/4 X 26-1/4 X 33-1/2
HB048HELCDCC1XX1	4	48,000	30.9	50	22 X 32-1/4 X 79
HB048HELXCXCC1XX1	4	48,000	30.9	50	22 X 32-1/4 X 79
HB048HELNDCC1XX1	4	48,000	30.9	50	22 X 32-1/4 X 79
HB048HELNXCC1XX1	4	48,000	30.9	50	22 X 32-1/4 X 79

Model Number	Size (tons)	Nominal Btu/hr	Min. Circuit Ampacity	Max. Fuse or Breaker	Dimensions H x W x D (sq) in.
HB024CBLCDDET1XX1	4	48,000	30.9	50	22 X 32-1/4 X 79
HB048HERCXCC1XX1	4	48,000	30.9	50	22 X 32-1/4 X 79
HB048HERNDCC1XX1	4	48,000	30.9	50	22 X 32-1/4 X 79
HB048HERNXCC1XX1	4	48,000	30.9	50	22 X 32-1/4 X 79
HB048HSLCDCC1XX1	4	48,000	30.9	50	22 X 32-1/4 X 79
HB048HSLCXCC1XX1	4	48,000	30.9	50	22 X 32-1/4 X 79
HB048HSLNDCC1XX1	4	48,000	30.9	50	22 X 32-1/4 X 79
HB048HSLNXCC1XX1	4	48,000	30.9	50	22 X 32-1/4 X 79
HB048HSRCDCC1XX1	4	48,000	30.9	50	22 X 32-1/4 X 79
HB048HSRCXCC1XX1	4	48,000	30.9	50	22 X 32-1/4 X 79
HB048HSRNDCC1XX1	4	48,000	30.9	50	22 X 32-1/4 X 79
HB048HSRNXCC1XX1	4	48,000	30.9	50	22 X 32-1/4 X 79
HB048VTLCDCC1XX1	4	48,000	30.9	50	58-1/4 X 26-1/4 X 33-1/2
HB048VTLXCC1XX1	4	48,000	30.9	50	58-1/4 X 26-1/4 X 33-1/2
HB048VTLNDCC1XX1	4	48,000	30.9	50	58-1/4 X 26-1/4 X 33-1/2
HB048VTLNXCC1XX1	4	48,000	30.9	50	58-1/4 X 26-1/4 X 33-1/2
HB048VTRCDCC1XX1	4	48,000	30.9	50	58-1/4 X 26-1/4 X 33-1/2
HB048VTRCXCC1XX1	4	48,000	30.9	50	58-1/4 X 26-1/4 X 33-1/2
HB048VTRNDCC1XX1	4	48,000	30.9	50	58-1/4 X 26-1/4 X 33-1/2
HB048VTRNXCC1XX1	4	48,000	30.9	50	58-1/4 X 26-1/4 X 33-1/2
HB060HELCDCC1XX1	5	60,000	38.9	60	22 X 30-1/4 X 89-1/4
HB060HELCXCC1XX1	5	60,000	38.9	60	22 X 30-1/4 X 89-1/4
HB060HELNDCC1XX1	5	60,000	38.9	60	22 X 30-1/4 X 89-1/4
HB060HELNXCC1XX1	5	60,000	38.9	60	22 X 30-1/4 X 89-1/4
HB060HERCDCC1XX1	5	60,000	38.9	60	22 X 30-1/4 X 89-1/4
HB060HERCXCC1XX1	5	60,000	38.9	60	22 X 30-1/4 X 89-1/4
HB060HERNDCC1XX1	5	60,000	38.9	60	22 X 30-1/4 X 89-1/4
HB060HERNXCC1XX1	5	60,000	38.9	60	22 X 30-1/4 X 89-1/4
HB060HSLCDCC1XX1	5	60,000	38.9	60	22 X 30-1/4 X 89-1/4
HB060HSLCXCC1XX1	5	60,000	38.9	60	22 X 30-1/4 X 89-1/4
HB060HSLNDCC1XX1	5	60,000	38.9	60	22 X 30-1/4 X 89-1/4
HB060HSLNXCC1XX1	5	60,000	38.9	60	22 X 30-1/4 X 89-1/4
HB060HSRCDCC1XX1	5	60,000	38.9	60	22 X 30-1/4 X 89-1/4
HB060HSRCXCC1XX1	5	60,000	38.9	60	22 X 30-1/4 X 89-1/4
HB060HSRNDCC1XX1	5	60,000	38.9	60	22 X 30-1/4 X 89-1/4
HB060HSRNXCC1XX1	5	60,000	38.9	60	22 X 30-1/4 X 89-1/4
HB060VTLCDCC1XX1	5	60,000	38.9	60	66-1/4 X 26-1/4 X 33-1/2
HB060VTLXCC1XX1	5	60,000	38.9	60	66-1/4 X 26-1/4 X 33-1/2
HB060VTLNDCC1XX1	5	60,000	38.9	60	66-1/4 X 26-1/4 X 33-1/2
HB060VTLNXCC1XX1	5	60,000	38.9	60	66-1/4 X 26-1/4 X 33-1/2
HB060VTRCDCC1XX1	5	60,000	38.9	60	66-1/4 X 26-1/4 X 33-1/2
HB060VTRCXCC1XX1	5	60,000	38.9	60	66-1/4 X 26-1/4 X 33-1/2
HB060VTRNDCC1XX1	5	60,000	38.9	60	66-1/4 X 26-1/4 X 33-1/2
HB060VTRNXCC1XX1	5	60,000	38.9	60	66-1/4 X 26-1/4 X 33-1/2

HS

R410-A Geothermal Split Heat Pump

2 – 5 Ton



Easier to Sell

- 3.4 - 4.5 COP, 15.4 - 26.4 EER (Closed Loop)
- 3.9 - 5.1 COP, 19.2 - 30.5 EER (Open Loop)
- Compressor blanket
- Fully insulated cabinet with closed cell foam
- Optional supplemental domestic water heating

Tougher

- Two-stage scroll compressor
- Used with variable-speed fan coil or furnace with evaporator coil



Qualifying models only.

Easier to Install and Service

- Unit compatible with ICP evaporator coils
- Compatible with FVM4X fan coils
- Microprocessor control
- Compatible with many three-stage heat, two-stage cooling programmable thermostats

Warranty*

- Five-year No Hassle Replacement™ limited warranty
- Five-year labor limited warranty
 - With timely registration, an additional five-year labor limited warranty
- 10-year labor limited warranty (including compressor)

* For residential applications only (owner occupied for No Hassle Replacement warranty). See warranty certificate for complete details and restrictions, including warranty coverage for other applications.

Unit Performance Data

Model Number	Size (tons)	Nominal Btu/hr	Min. Circuit Ampacity	Max. Fuse or Breaker	Dimensions H x W x D (sq) in.	Operating (Shipping) Wt lbs.
HS024SXXCDXX1XX1	2	24,000	14.6	25	21-1/2 X 24 X 27-3/8	189 (172)
HS024SXXCXXX1XX1	2	24,000	14.6	25	21-1/2 X 24 X 27-3/8	189 (172)
HS024SXXNDXX1XX1	2	24,000	14.6	25	21-1/2 X 24 X 27-3/8	189 (172)
HS024SXXNXXX1XX1	3	36,000	19.1	30	21-1/2 X 24 X 27-3/8	189 (172)
HS036SXXCDXX1XX1	3	36,000	19.1	30	21-1/2 X 24 X 27-3/8	189 (172)
HS036SXXCXXX1XX1	3	36,000	19.1	30	21-1/2 X 24 X 27-3/8	189 (172)
HS036SXXNDXX1XX1	3	36,000	19.1	30	21-1/2 X 24 X 27-3/8	189 (172)
HS036SXXNXXX1XX1	3	36,000	19.1	30	21-1/2 X 24 X 27-3/8	189 (172)
HS048SXXCDXX1XX1	4	48,000	26.5	45	21-1/2 X 24 X 27-3/8	189 (172)
HS048SXXCXXX1XX1	4	48,000	26.5	45	21-1/2 X 24 X 27-3/8	189 (172)
HS048SXXNDXX1XX1	4	48,000	26.5	45	21-1/2 X 24 X 27-3/8	189 (172)
HS048SXXNXXX1XX1	4	48,000	26.5	45	21-1/2 X 24 X 27-3/8	189 (172)
HS060SXXCDXX1XX1	5	60,000	33.9	60	23-1/4 X 27 X 33-3/8	261 (237)
HS060SXXCXXX1XX1	5	60,000	33.9	60	23-1/4 X 27 X 33-3/8	261 (237)
HS060SXXNDXX1XX1	5	60,000	33.9	60	23-1/4 X 27 X 33-3/8	261 (237)
HS060SXXNXXX1XX1	5	60,000	33.9	60	23-1/4 X 27 X 33-3/8	261 (237)



Easier to Sell

- 3.0 - 3.2 COP, 14.6 - 22.1 EER (Closed Loop)
- 3.4 - 3.8 COP, 18.8 - 25.7 EER (Open Loop)
- Fully insulated cabinet with fiberglass
- Compressor blanket
- Optional supplemental domestic water heating

Tougher

- Two-stage scroll compressor



Qualifying models only.

Easier to Install and Service

- Unit designed for variety of hydronic applications
- Microprocessor control

Warranty*

- Five-year No Hassle Replacement™ limited warranty
- Five-year labor limited warranty
 - With timely registration, an additional five-year labor limited warranty
- 10-year parts limited warranty (including compressor)

* For residential applications only (owner occupied for No Hassle Replacement warranty).
See warranty certificate for complete details and restrictions, including warranty coverage for other applications.

Unit Performance Data

Model Number	Size (tons)	Nominal Btu/hr	Min. Circuit Ampacity	Max. Fuse or Breaker	Dimensions H x W x D in.	Ship/Operating Weight lbs.
HW024WXXDDXX1XX1	2	24,000	14.6	25	24-1/8 x 32-1/2 x 24	250 (270)
HW024WXXDXXX1XX1	2	24,000	14.6	25	24-1/8 x 32-1/2 x 24	250 (270)
HW024WXXEDXX1XX1	2	24,000	14.6	25	24-1/8 x 32-1/2 x 24	250 (270)
HW024WXXEXXX11XX1	2	24,000	14.6	25	24-1/8 x 32-1/2 x 24	250 (270)
HW024WXXFDXX1XX1	2	24,000	14.6	25	24-1/8 x 32-1/2 x 24	250 (270)
HW024WXXFXXX1XX1	2	24,000	14.6	25	24-1/8 x 32-1/2 x 24	250 (270)
HW024WXXGDXX1XX1	2	24,000	14.6	25	24-1/8 x 32-1/2 x 24	250 (270)
HW024WXXGXXX1XX1	2	24,000	14.6	25	24-1/8 x 32-1/2 x 24	250 (270)
HW036WXXDDXX1XX1	3	36,000	19.1	30	24-1/8 x 32-1/2 x 24	270 (290)
HW036WXXDXXX1XX1	3	36,000	19.1	30	24-1/8 x 32-1/2 x 24	270 (290)
HW036WXXEDXX1XX1	3	36,000	19.1	30	24-1/8 x 32-1/2 x 24	270 (290)
HW036WXXEXXX1XX1	3	36,000	19.1	30	24-1/8 x 32-1/2 x 24	270 (290)
HW036WXXFDXX1XX1	3	36,000	19.1	30	24-1/8 x 32-1/2 x 24	270 (290)
HW036WXXFXXX1XX1	3	36,000	19.1	30	24-1/8 x 32-1/2 x 24	270 (290)
HW036WXXGDXX1XX1	3	36,000	19.1	30	24-1/8 x 32-1/2 x 24	270 (290)
HW036WXXGXXX1XX1	3	36,000	19.1	30	24-1/8 x 32-1/2 x 24	270 (290)

HW con't

R410-A Geothermal Split Heat Pump

Unit Performance Data

Model Number	Size (tons)	Nominal Btu/hr	Min. Circuit Ampacity	Max. Fuse or Breaker	Dimensions H x W x D in.	Ship/Operating Weight lbs.
HW048WXXDDXX1XX1	4	48,000	26.5	45	24-1/8 x 32-1/2 x 24	252 (270)
HW048WXXDXXX1XX1	4	48,000	26.5	45	24-1/8 x 32-1/2 x 24	252 (270)
HW048WXXEDXX1XX1	4	48,000	26.5	45	24-1/8 x 32-1/2 x 24	252 (270)
HW048WXXEXXX11XX1	4	48,000	26.5	45	24-1/8 x 32-1/2 x 24	252 (270)
HW048WXXFDXX1XX1	4	48,000	26.5	45	24-1/8 x 32-1/2 x 24	252 (270)
HW048WXXFXXX1XX1	4	48,000	26.5	45	24-1/8 x 32-1/2 x 24	252 (270)
HW048WXXGDXX1XX1	4	48,000	26.5	45	24-1/8 x 32-1/2 x 24	252 (270)
HW048WXXGXXX1XX1	4	48,000	26.5	45	24-1/8 x 32-1/2 x 24	252 (270)
HW060WXXDDXX1XX1	5	60,000	33.9	60	24-1/8 x 32-1/2 x 24	340 (360)
HW060WXXDXXX1XX1	5	60,000	33.9	60	24-1/8 x 32-1/2 x 24	340 (360)
HW060WXXEDXX1XX1	5	60,000	33.9	60	24-1/8 x 32-1/2 x 24	340 (360)
HW060WXXEXXX1XX1	5	60,000	33.9	60	24-1/8 x 32-1/2 x 24	340 (360)
HW060WXXFDXX1XX1	5	60,000	33.9	60	24-1/8 x 32-1/2 x 24	340 (360)
HW060WXXFXXX1XX1	5	60,000	33.9	60	24-1/8 x 32-1/2 x 24	340 (360)
HW060WXXGDXX1XX1	5	60,000	33.9	60	24-1/8 x 32-1/2 x 24	340 (360)
HW060WXXGXXX1XX1	5	60,000	33.9	60	24-1/8 x 32-1/2 x 24	340 (360)
HW072WXXDDXX1XX1	6	72,000	37.1	60	24-1/8 x 32-1/2 x 24	340 (360)
HW072WXXDXXX1XX1	6	72,000	37.1	60	24-1/8 x 32-1/2 x 24	360 (380)
HW072WXXEDXX1XX1	6	72,000	37.1	60	24-1/8 x 32-1/2 x 24	360 (380)
HW072WXXEXXX1XX1	6	72,000	37.1	60	24-1/8 x 32-1/2 x 24	360 (380)
HW072WXXFDXX1XX1	6	72,000	37.1	60	24-1/8 x 32-1/2 x 24	360 (380)
HW072WXXFXXX1XX1	6	72,000	37.1	60	24-1/8 x 32-1/2 x 24	360 (380)
HW072WXXGDXX1XX1	6	72,000	37.1	60	24-1/8 x 32-1/2 x 24	360 (380)
HW072WXXGXXX1XX1	6	72,000	37.1	60	24-1/8 x 32-1/2 x 24	360 (380)

Residential Flow Centers

Flo-Link Series (Double O-Ring) Pressurized Flow Centers	
Part Number	Description
Flo-Link Foamed Cabinet (Double O-Ring Connections – Brass Valves)	
FCP11BD	FL1-99 USPS26-99, Three-Speed, 230V, Grundfos
FCP12BD	FL1-116 UP26-116, Single-Speed, 230V, Grundfos
FCP13BD	FLV1, UPS32-140 (Variable-Speed), 230V, Grundfos
FCP21BD	FL2-99 UPS26-99, Three-Speed, 230V, Grundfos, Quantity: 2
FCP22BD	FL2-116 UP26-116, Single-Speed, 230V, Grundfos, Quantity: 2
FCP24BD	FLV2, one UPS32-140 (Variable-Speed) and one UPS26-99 (Three-Speed), 230V, Grundfos*

*Variable-speed flow centers require a controller package. See Accessory section of Geothermal System Components Catalog.

Note: Each unit contains: Mounting hardware and one set of Flo-Link by 1-1/4 in. fusion fittings (loop side).

Part Number	Description
Flo-Link Foamed Cabinet (Double O-Ring Connections – Composite Valves)	
FCP11CD	FL1-99 USPS26-99, Three-Speed, 230V, Grundfos
FCP21CD	FL2-99 UPS26-99, Three-Speed, 230V, Grundfos, Quantity: 2

Note: Each unit contains: Mounting hardware and one set of Flo-Link by 1-1/4 in. fusion fittings (loop side).

Panel Mount Variable-Speed Flow Centers			
Part Number	Description		
	Variable-Speed Pre-Wired Packages (Panel Mounted)		
	Flow Center	Control	Connections
FCM13BDT	Single Pump, Brass Valves	Temperature Difference	Hose Kit / PE Fusion*
FCM13BDF	Single Pump, Brass Valves	Flow & Temperature Control	Hose Kit / PE Fusion*
FCM24BDT	Two Pump, Brass Valves	Temperature Difference	Hose Kit / PE Fusion*
FCM24BDF	Two Pump, Brass Valves	Flow & Temperature Control	Hose Kit / PE Fusion*

*Kit includes all of the fittings necessary for connecting to the ground loop (1-1/4" PE fusion) and to the heat pump (1" MPT).

GPM Series (FPT) Pressurized Flow Centers	
Part Number	Description
GPM-1 with Foamed Cabinet (FPT Connections)	
FCP11BF	GPM-1 UPS26-99, Three-Speed, 230V Grundfos
FCP12BF	GPM-1 UP26-116, Single-Speed, 230V Grundfos
GPM-2 with Foamed Cabinet (FPT Connections)	
FCP21BF	GPM-2 UPS26-99, Three-Speed, 230V Grundfos, Quantity: 2
FCP22BF	GPM-2 UP26-116, Single-Speed, 230V Grundfos, Quantity: 2
GPM-3 with Foamed Cabinet (FPT Connections)	
FCP31BF	GPM-3 UPS26-99, Three-Speed, 230V Grundfos, Quantity: 3
FCP32BF	GPM-2 UP26-116, Single-Speed, 230V Grundfos, Quantity: 3
GPM-4 with Foamed Cabinet (FPT Connections)	
FCP41BF	GPM-4 UPS26-99, Three-Speed, 230V Grundfos, Quantity: 4
FCP42BF	GPM-2 UP26-116, Single-Speed, 230V Grundfos, Quantity: 4

Note: Each unit contains: Mounting hardware.

Accessories

Geothermal

NP Series Non-Pressurized Flow Center	
Part Number	Description
NP¹ with Foamed Cabinet (Flo-Link Double O-Ring Connections)	
FCN11CD	NP ¹ UPS26-99, Three-Speed, 230V, Grundfos
FCN12CD	NP ¹ UP26-116, Single-Speed, 230V, Grundfos
NP² with Foamed Cabinet (Flo-Link Double O-Ring Connections)	
FCN21CD	NP ² UPS26-99, Three-Speed, 230V, Grundfos, Quantity: 2
FCN22CD	NP ² UP26-116, Single-Speed, 230V, Grundfos, Quantity: 2
NP^V and NP^{V2} with Foamed Cabinet (Flo-Link Double O-Ring Connections)	
FCN13CD	NP ^V Magna GEO (Variable-Speed), 230V, Grundfos*
FCN24CD	NP ^{V2} One Magna GEO (Variable-Speed) and One UPS26-99 (Constant Speed), 230V, Grundfos*

*Variable-speed flow centers require a controller package.

Note: Requires Flo-Link adapter sets for all connections or connector kit.

Hose Kits	
Part Number	Description
1-inch Hose Kit (MPT @ Flow Center and Heat Pump)	
HK4MM	<p>Hose Kit Contents:</p> <ul style="list-style-type: none"> Quantity 1: 12 ft. 1-inch ID Black Hose Quantity 2: Insulating Boot Quantity 2: Insulating Boot Caps Quantity 2: PT Plug, 1/4" MPT Quantity 2: Fitting, 1" MPT x 1" Hose Barb (flow center connection) Quantity 2: Elbow, 1" MPT x 1" Hose Barb with PT Port (heat pump connection) Quantity 8: Hose Clamps
1-inch Hose Kit (Flo-Link Double O-Ring @ Flow Center; MPT™ HP)	
HK4DM	<p>Hose Kit Contents:</p> <ul style="list-style-type: none"> Quantity 1: 12 ft. 1-inch ID Black Hose Quantity 2: Insulating Boot Quantity 2: Insulating Boot Caps Quantity 2: PT Plug, 1/4" MPT Quantity 2: Fitting, Flo-Link x 1" Hose Barb (flow center connection) Quantity 2: Elbow, 1" MPT x 1" Hose Barb with PT Port (heat pump connection) Quantity 8: Hose Clamps

Fittings	
Part Number	Description
PE and PVC Adapters	
FIS4D5U	Flo-Link x 1-1/4" PE Fusion
FIS4D4U	Flo-Link x 1" PE Fusion
FIS4D5P	Flo-Link x 1-1/4" PVC Glue
Brass Adapters - Hose Barb	
FIS4D4B	Flo-Link x 1" Hose Barb
FIS4D4V	Flo-Link x 1" Hose Barb (with check valve)
FIS4D5B	Flo-Link x 1-1/4" Hose Barb
Brass Adapters - Threaded	
FIS4D4M	Flo-Link x 1" MPT
FIS4D4F	Flo-Link x 1" FPT
FIS4E4M	Flo-Link (female) x 1" MPT
FIS4D4J	Flo-Link x 1" FPT Full Port Isolation Valves
FIN4M4F	Flo-Link 1" MPT x 1" FPT 45Y angle
Brass Adapters with Fitting for PT Port	
FIS4T4B	Flo-Link x 1" Hose Barb with Fitting for PT Port
FIE4T4B	Flo-Link Elbow x 1" Hose Barb with Fitting for PT Port
FIS4T4M	Flo-Link x 1" MPT with Fitting for PT Port
FIE4T4M	Flo-Link Elbow x 1" MPT with Fitting for PT Port
FIS4DSS	Flo-Link x 1-1/8" Sweat with Fitting for PT Port
FIE4M4F	Flo-Link 1" MPT x 1" FPT Elbow with PT Plugs and Port
Installation/Service Adapters	
FIE4D4C	Flo-Link x Male Cam Adapter
FIS4D3G	Flo-Link by Male Garden Hose Adapter
FIS4D3H	Flo-Link x Female Garden Hose Adapter
Threaded Fittings, Adapters and Other Fitting Components	
FIE4M4B	1" MPT Elbow x 1" Hose Barb with Fitting for PT Port
FIS4M5B	1" MPT x 1-1/4" Hose Barb
FIE4A4A	Insulating Boot Set for 1" Elbows
FIS4Z4W	Water Heater Adapter (Use ASME Rated Water Heater as Buffer Tank)
FIS4M4C	1" MPT x 1" CAM, Aluminum

Accessories

Geothermal

Part Number	Description
Loop Pressurization	
ACPB	Pressure Battery (Polyethylene Expansion Tank) – Up to 6 Tons
ACGB	Geo-Booster (Loop Pressurization System – 35 psig)
ACGP	Geo-Prime Tank*
Pressure/Temperature Plugs	
ACPTP1	1/4" P/T Plug (each)
ACPTP2	1/2" P/T Plug (each)
Controllers for Variable-Speed Flow Centers	
ACVCT	Grundfos Magna GEO Controller(for NPV and NPV2) – Temperature Control (Hose Kit or PVC Connections – 1/4" MPT Immersion Thermistors Included)
ACVCFHB	Grundfos Magna GEO Controller (for NPV and NPV2) – Temperature and Flow Control for Hose Kit Connections
ACVCFPVC	Grundfos Magna GEO Controller (for NPV and NPV2) – Temperature and Flow Control for PVC Connections
Two Heat Pump Flow Center Sharing Control	
ACPSRN	Pump Sharing Relay (Two Units; One Flow Center) with NEMA encl.

*Use with Flo-Link flow centers or insulated pumps. May also be used with GPM flow centers with Flo-Link female x 1" MPT adapter.

NP Series Connector Kit	
Part Number	Description
NP Series Hose Kit with Three-Way Flushing/Purging Valve	
ACCKNP	<p>Hose Kit Contents:</p> <p>Quantity 1: 12 ft. 1-inch ID Black Hose, 150 psi</p> <p>Quantity 4: Insulating Boot</p> <p>Quantity 2: Elbow, 1" MPT x 1" Hose Barb with PT Port (heat pump connections)</p> <p>Quantity 2: PT Plug, 1/4" MPT</p> <p>Quantity 2: Elbow, 1/4" Plugs, Flo-Link x 1" Hose Barb (flow center connections)</p> <p>Quantity 1: Three-Way Valve, Single, Composite, Flo-Link Fittings</p> <p>Quantity 1: 1-1/4" PE Fusion x Flo-Link (Three-way Valve Connection to Ground Loop)</p> <p>Quantity 1: Flo-Link x 1" Hose Barb (Three-Way Valve Connection to Heat Pump)</p> <p>Quantity 1: 1-1/4" PE Fusion x 1" Hose Barb (Ground Loop Connection to Hose at Flow Center, RH Side)</p> <p>Quantity 12: Hose Clamps</p>

Compatible with NP Series flow centers and heat pumps with 1" FPT connections.

Unit Mounting Pad	
Part Number	Description
ACMP2436	3/4" High Density Rubber Equipment Pad, 24" x 36"
ACMP2836	3/4" High Density Rubber Equipment Pad, 28" x 36"

Open Loop Accessories	
Part Number	Description
Motorized Solenoid Valves	
MVBR3F	Valve, Motorized Solenoid, Forged Brass 3/4" FPT, 24V with End Sw
MVBR4F	Valve, Motorized Solenoid, Forged Brass 1" FPT, 24V with End Sw
Flow Regulator Valves	
FR2	Valve, Flow Regulator, 3/4" FPT x 3/4" FPT, 2 GPM
FR3	Valve, Flow Regulator, 3/4" FPT x 3/4" FPT, 3 GPM
FR4	Valve, Flow Regulator, 3/4" FPT x 3/4" FPT, 4 GPM
FR5	Valve, Flow Regulator, 3/4" FPT x 3/4" FPT, 5 GPM
FR6	Valve, Flow Regulator, 3/4" FPT x 3/4" FPT, 6 GPM
FR7	Valve, Flow Regulator, 3/4" FPT x 3/4" FPT, 7 GPM
FR8	Valve, Flow Regulator, 3/4" FPT x 3/4" FPT, 8 GPM
FR9	Valve, Flow Regulator, 3/4" FPT x 3/4" FPT, 9 GPM

Fusion and Service Tools	
Part Number	Description
Flush Care and Accessories	
TLFLC2	Flush Cart*
TLFLH1	Hose Assembly, Flush Cart (set of 2, 10 feet) – 1" CAM Fittings (loop side)
FLFLH2	Hose Assembly, Flush Cart (set of 2, 10 feet) – 1-1/4" Ball Valves
TLFFLH3	Hose Assembly (set of 2, 20 feet) – 1-1/2" CAM Fittings (loop side)**
TLFB100	Filter Bag, 100 micron, for Flush Cart (each)
TLFB001	Filter Bag, One micron, for Flush Cart
Loop Tools and Accessories	
TLGG0	Geo-Gooser Loop Pressurization Device
TLDTH	Thermometer, Digital with Case
TLPG1	Pressure Gauge, 0-100 psig, 3-1/2" dial with PT Adapter
TLGAD	Gauge Adapter P/T Plug with Guard
TLHYD	Hydrometer, Alcohols
TLMFI	AC Magnetic Field Indicator (check pump operation)
TLFLK	Loop Service and Flush Kit

*B12 Ships with Hose Set with 1-1/4" Ball Valve.

**Ships with 2-CAM male x male adapters. May be used as an extension set or with Flo-Link XL Flow Centers.

Fusion and Service Tools for NP Series	
Part Number	Description
GEO-Meter Flow Meter Tool	
TLNPFMT	Mechanical (variable area) Flow Meter Tool
TLNPBDA	Adapter Kit or B and D Flow Meter Tool (allows B & D Tool to be used with NP Series Flow Centers)

Flow meter tool contains: Tool with fittings, 90° cam x double O-ring adapter, straight cam x double O-ring adapter, B & D adapter, and carrying case.

Accessories

Geothermal

Fusion and Service Tools for NP Series	
Part Number	Description
Fusion Tools	
TLHFD	Heat Fusion Tool – Double Face
TLFKT	Fusion Tool Kit 3/4", 1-1/4", and 2" Includes: Complete Fusion Tool Set (3/4", 1-1/4" and 2") Heating Tool with Cover, Socket Faces, Cold Rings, 1-1/4" and 2" Chamfer Tools, Tool Box Timer, Temple Sticks, Up to 2" Ratchet Cutter
Socket Faces	
TLSF3	3/4" IPS Socket Face Set
TLSF4	1" IPS Socket Face Set
TLSF5	1-1/4" IPS Socket Face Set
TLSF6	1-1/2" IPS Socket Face Set
TLSF8	2" IPS Socket Face Set
Cold Rings Vice Grip Clamp	
TLCR3	3/4" IPS Cold Ring Vice Grip Clamp
TLCR4	1" IPS Cold Ring Vice Grip Clamp
TLCR5	1-1/4" IPS Cold Ring Vice Grip Clamp
TLCR6	1-1/2" IPS Cold Ring Vice Grip Clamp
TLCR8	2" IPS Cold Ring Vice Grip Clamp
Depth Gauge/Chamfer Tool	
TLDG3	3/4" IPS Depth Gauge/Chamfer Tool
TLDG4	1" IPS Depth Gauge/Chamfer Tool
TLDG5	1-1/4" IPS Depth Gauge/Chamfer Tool
TLDG6	1-1/2" IPS Depth Gauge/Chamfer Tool
TLDG8	2" IPS Depth Gauge/Chamfer Tool
Fusion Tools	
TLFHO	Fitting Holder – 2" IPS
TLFTI	Fusion Timer
TLTS5	Temp Stick – PE, 500° F
TLMBR	Mounting Bracket for Fusion Tool
TLFHB	Fusion Tool Heater Bag
Pipe Cutters	
TLPC4	PE Cutter – Up to 1"
TLPC5	PE Ratchet Cutter – Up to 1-1/4"
TLPC8	PE Ratchet Cutter – Up to 2"

Auxiliary Heaters		
Part Number	Description	Used With
KWBEH0101N05	Non-Fused 5 Kw	HP 024-036, HB 018-036
KWBEH0101N10	Non-Fused 10 Kw	HP 024-036, HB 024-060
KWBEH0101N15	Breaker 15 Kw	HP 048-072, HB 036-060
KWBEH0101N20	Breaker 20 Kw	HP 060-072, HB 048-060

