

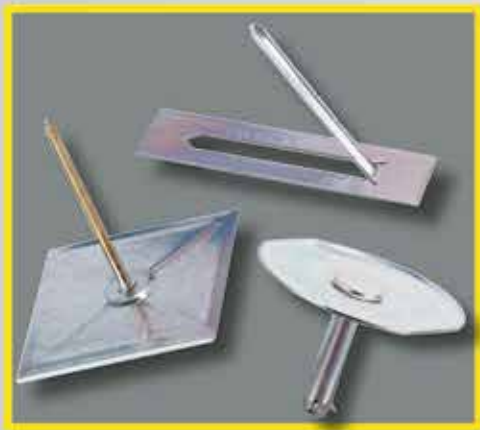

# INSULATION FASTENING



# PRODUCT CATALOG



# WELD TYPE FASTENERS

Duro Dyne Insulation Fasteners provide a means of securing duct liner to the duct work. They are available in a variety of styles, which all feature a precision formed point to insure constant penetration of the duct liner. Once the duct liner is pierced, the fastener is in firm electrical contact with the duct work and the pinspotter current securely welds the fastener in place.

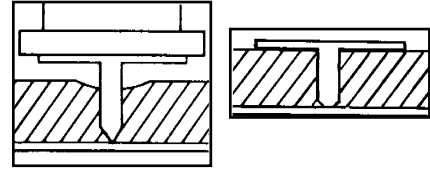

Duro Dyne Insulation Fasteners are for use with MF, PBF, FG, RH, FGMH, and HSMH pinspotters.

## RIB PIN<sup>®</sup>



Duro Dyne Rib Pins (CP) have dished washers, ribbed nails for faster post weld cooling and precision points to assure uniform quality.

Item#	Bulk#	Code/Bulk Code	Pin Size	Duct Liner Size	Quantity
26023	26028	CP12/ <b>CPB12</b>	1/2in	1/2in	1 TH/5 TH
26024	26029	CP34/ <b>CPB34</b>	3/4in	1in	1 TH/5 TH
26025	26030	CP100/ <b>CPB100</b>	1in	1in HD	1 TH/5 TH
26032	26035	CP118/ <b>CPB118</b>	1-1/8in	1in HD	1 TH/3 TH
26026	26031	CP150/ <b>CPB150</b>	1-1/2in	1-1/2in	1 TH/3 TH
26027	26038	CP200/ <b>CPB200</b>	2in	2in	1 TH/3 TH

## TARGET PINS<sup>®</sup>



Patent  
#6,497,543

Target (BDEP) pins are a patented insulation fastener designed with an aerodynamic embossed washer and a recessed nail head to improve the quilting contour of the secured duct liner.



\*Sold in buckets

Item#	Code	Pin Size	Duct Liner Size	Quantity*
26220	BDEP12	1/2in	1/2in	5 TH
26221	BDEP34	3/4in	1in	5 TH
26222	BDEP100	1in	1in HD	5 TH
26217	BDEP118	1-1/8in	1in HD	3 TH
26218	BDEP150	1-1/2in	1-1/2in	3 TH
26219	BDEP200	2in	2in	3 TH
26216	BDEP218	2-1/8in	2in HD	3 TH

## SLOPE PINS<sup>®</sup>



Sloped Washer (CTC) pins are low cost insulation fasteners designed to provide a strong mechanical anchor point for duct liner and a smooth transition from the insulation surface to the quilting depression.

Item#	Code	Pin Size	Duct Liner Size	Quantity
26228	CTC12	1/2in	1/2in	5 TH
26229	CTC34	3/4in	1in	5 TH
26230	CTC100	1in	1in HD	5 TH
26231	CTC118	1-1/8in	1in HD	3 TH
26232	CTC150	1-1/2in	1-1/2in	3 TH
26233	CTC200	2in	2in	3 TH

## ECONO POINT



Econo Point (FTC) weld pins utilize a specially pointed nail to assure uniform welding.

Item#	Code	Pin Size	Duct Liner Size	Quantity
26072	FTC12	1/2in	1/2in	5 TH
26073	FTC34	3/4in	1in	5 TH
26074	FTC100	1in	1in HD	5 TH
26131	FTC118	1-1/8in	1in HD	3 TH
26226	FTC150	1-1/2in	1-1/2in	3 TH
26227	FTC200	2in	2in	3 TH

TH = Thousand

# WELD TYPE FASTENERS

## GOLD SEAL PINS SELF SEALING PIN

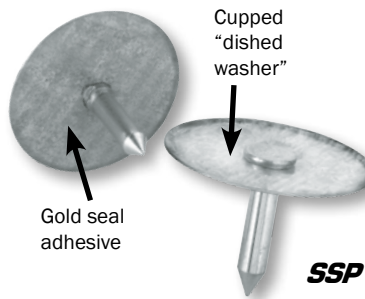

Gold Seal (SSP) pins are considered self sealing pins due to a heat activated gold adhesive on the underside of the washer which secures the pin to the liner facing during the welding process. Gold Seal Pins also feature "dished washers". Do not store at or above 110°F or pins may stick together.

Item#	Bulk#	Code/Bulk Code	Duct Liner Size	Quantity
26197	26297	SSP12/SSPB12	1/2in	1 TH/5 TH
26194	26294	SSP34/SSPB34	1in	1 TH/5 TH
26195	26295	SSP100/SSPB100	1in HD	1 TH/5 TH
26199	26293	SSP1F/SSPB1F	Foam	1 TH/5 TH
26188	26299	SSP118/SSPB118	1in HD	1 TH/3 TH
26189	26300	SSP150/SSPB150	1-1/2in	1 TH/3 TH
26196	26296	SSP200/SSPB200	2in	1 TH/3 TH
26190	26191	SSP218/SSPB218	2-1/8in	1 TH/3 TH
n/a	26305	SSPB250	2-1/2in	3 TH
26303	n/a	SSP300	3in	1 TH
26304	n/a	SSP400	4in	1 TH

## SPOTTER PIN (PN)

The spotter pin is welded to the sheet metal and the insulation is impaled over the nail. It is held in place with the addition of a galvanized steel washer.

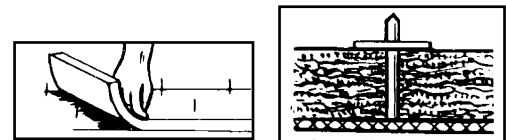

After the pins are welded to the duct, (1 pin per sq. ft.), press the insulation onto the pins. Pins used should be 1/4" longer than the insulation thickness. Push clip over pin to hold insulation firmly in place.

## PN SPOTTER PINS

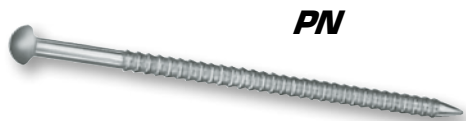

PN Spotter pins are manufactured with 14 gauge galvanized steel and are designed for use with LF Handheld Pinspotters. They can also be used with MF and PBF Portable Pinspotters with a TP-2 Tip.

Item#	Bulk#	Code/Bulk Code	Duct Liner Size	Quantity
26001	26005	PN34/PNB34	1/2in	1 TH/15 TH
26002	26006	PN114/PNB114	1in	1 TH/15 TH
26003	26007	PN200/PNB200	2in	1 TH/ 15 TH
26004	26008	PN250/PNB250	3in	1 TH/15 TH

## PC SPOTTER CLIPS



PC Spotter Clips are manufactured of 30 gauge galvanized steel and are used for securing insulation with PN spotter pins.

Item#	Bulk#	Code/Bulk Code	Quantity
26017	26019	PC1/PCB1	1 TH/15 TH

# MECHANICAL TYPE FASTENERS

## SAH DYNASTICK® SELF ADHESIVE INSULATION HANGER

All Dynastick hangers are sold with a washer.

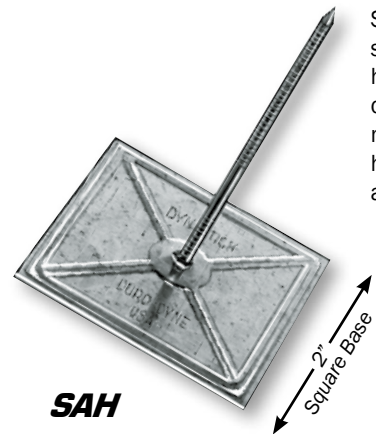

SAH Dynastick is an insulation hanger with a self-stick base. Just peel the release paper from the hanger base and firmly press the base to the clean duct surface. Impale the insulation over the hanger nail and slip on the locking washer. Self-stick hangers adhere to clean metal surfaces and withstand temperatures of up to 175 °F.

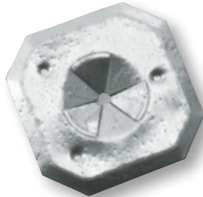

**LPC1**  
Galvanized Steel Washer

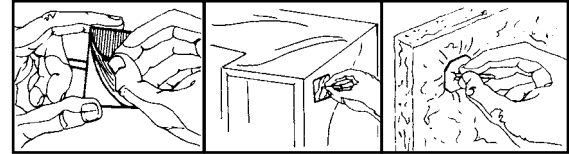

PEEL OFF PROTECTIVE PAPER

PRESS PIN FIRMLY TO SURFACE

IMPALE THE INSULATION AND PRESS DOWN WASHER OVER PIN

Item#	Bulk#	Code/Bulk Code	Hanger Size	Quantity
26067	26036	SAH34/ <b>SAHB34</b>	3/4in	1 TH/ <b>500</b>
26068	26037	SAH114/ <b>SAHB114</b>	1-1/4in	1 TH/ <b>500</b>
26069	26040	SAH134/ <b>SAHB134</b>	1-3/4in	1 TH/ <b>500</b>
26070	26041	SAH200/ <b>SAHB200</b>	2in	1 TH/ <b>500</b>
26071	26047	SAH250/ <b>SAHB250</b>	2-1/2in	1 TH/ <b>500</b>
n/a	26126	<b>SAHB350</b>	3-1/2in	<b>500</b>
n/a	26127	<b>SAHB450</b>	4-1/2in	<b>500</b>

## PBH DYNASTICK® INSULATION HANGER

All Dynastick hangers are sold with a washer.

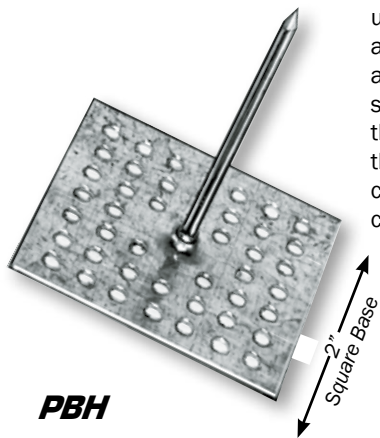

PBH Dynastick is a perforated base hanger for use with super strength PBA mastic. Simply place a small amount of PBA on a perforated base and firmly press the hanger against the duct surface. Allow the PBA mastic to dry, then impale the insulation over the hanger nail and slip on the locking washer. Duro Dyne PBA adheres to concrete, metal or wood surfaces and withstands constant temperatures up to 180 °F.

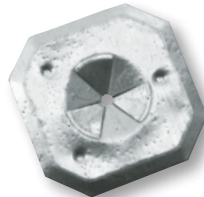

**LPC1**  
Galvanized Steel Washer

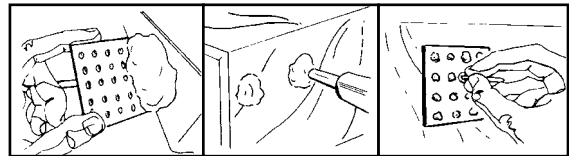

APPLY ADHESIVE WITH FLAT EDGE

OR APPLY ADHESIVE WITH CAULKING GUN

PRESS PIN FIRMLY TO SURFACE

Item#	Bulk#	Code/Bulk Code	Hanger Size	Quantity
26075	26097	PBH34/ <b>PBHB34</b>	3/4in	1 TH/ <b>500</b>
26076	26098	PBH114/ <b>PBHB114</b>	1-1/4in	1 TH/ <b>500</b>
26077	26099	PBH134/ <b>PBHB134</b>	1-3/4in	1 TH/ <b>500</b>
26078	26100	PBH200/ <b>PBHB200</b>	2in	1 TH/ <b>500</b>
26079	26101	PBH250/ <b>PBHB250</b>	2-1/2in	1 TH/ <b>500</b>
n/a	26128	<b>PBHB350</b>	3-1/2in	<b>500</b>
n/a	26112	<b>PBHB450</b>	4-1/2in	<b>500</b>

## PBA DYNASTICK® ADHESIVE



Duro Dyne PBA adheres to concrete, metal or wood surfaces and withstands constant temperatures up to 180 °F.

Item#	Code	Quantity
26049	PBA1	4 Gal/ctn

## LPC1 GALVANIZED STEEL WASHER

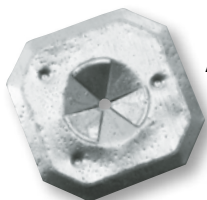

**LPC1**

LPC1 washers are included with most mechanical type fasteners. However, they can also be purchased separately.

Item#	Bulk#	Code/Bulk Code	Quantity
26115	26093	LPC1/ <b>LPC1B</b>	100/ <b>500</b>

# MECHANICAL TYPE FASTENERS

## FLIPSTIX® SELF ADHESIVE INSULATION HANGER WITH THE UNIQUE "ONE PIECE" DESIGN

All Flipstix are sold with a galvanized steel, stainless steel or aluminum washer.

A unique insulation hanger with a self stick base. One fastener can be used for insulation up to 2" thick. Optional extension (FSG-E) allows for use on up to 6" thick insulation or wrap. It is the only fastener available in galvanized, aluminum and stainless steel. Insulation can be secured simply by bending the tip of the extended pin or using supplied washers. Flipstix can be used on any clean metal or painted surface and will withstand temperatures of up to 175° F.



Item#	Code	Description	Quantity
26055	FSG250	FlipStix Hanger & Washer Galvanized Steel	1 TH
26056	FSA250	FlipStix Hanger & Washer Aluminum	1 TH
26057	FSS250	FlipStix Hanger & Washer Stainless Steel	1 TH
Item#	Code	Description	Quantity
26061	FSG-E	FlipStix Extension Galvanized Steel	1 TH
26054	FSA-E	FlipStix Extension Aluminum	1 TH
26063	FSS-E	FlipStix Extension Stainless Steel	1 TH
Item#	Code	Description	Quantity
26050	FSW-G	FlipStix Washer Galvanized Steel	100
26051	FSW-A	FlipStix Washer Aluminum	100
26052	FSW-S	FlipStix Washer Stainless Steel	100

## BANGER®

### IMPACT DRIVEN FASTENERS

Easy to install - place the liner over the sheet metal and drive the banger through the insulation. Upon impact, the jaws of the fastener penetrates the metal and locks securely within the thickness of the metal itself. (Always place a hardened steel block behind the sheet metal at the point of impact). Bangers can be installed with model DHH Double Headed Hammer or AB-5 Automatic Banger Setter.

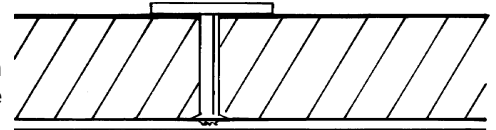

## TRIPOD® BANGER®



Tripod Bangers feature three prong jaws for added stability when fastening the banger to the sheet metal. They are 10 gauge and zinc chromate plated.

Item#	Bulk#	Code/Bulk Code	Duct Liner Size/Weight	Quantity
26129	26133	TBG12/TBGB12	1/2in 2lb	1 TH/5 TH
26130	26134	TBG100/TBGB100	1in 1-1/2 lb	1 TH/5 TH

## STANDARD BANGER®



Standard Bangers have two prong jaws to fasten to the sheet metal. They are 10 gauge and zinc chromate plated.

Item#	Bulk#	Code/Bulk Code	Duct Liner Size/Weight	Quantity
26033	26095	BGT12/BGB12	1/2in 2lb	1 TH/5 TH
26044	26096	BGT100/BGB100	1in 1-1/2lb	1 TH/5 TH

## DOUBLE HEADED HAMMER



Double sided, magnetic heads work great with Bangers.

Item#	Code	Description
27016	DHH	Double Headed Hammer

# ADHESIVE APPLICATORS

## SUPER SPRAYFAST UNIVERSAL *FOR USE WITH WIT & WSA ADHESIVES*

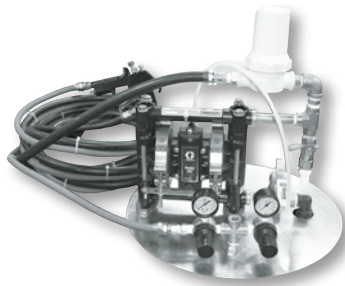

The revamped Universal version of our Super Sprayfast Adhesive Applicator (SSFU) machine makes it possible to use the same applicator on either a 5 gallon bucket or 55 gallon drum. In addition, it now also includes a new flush kit for easy clean up and maintenance. The SSFU features an acetal/teflon diaphragm pump circulating system and surge tank to provide quick, easy and even spray, with minimal overspray.

Item#	Code	Description
5151	SSFU	Super Sprayfast Universal Adhesive Applicator



5 gallon & 55 gallon pick-up tubes included

## GBAC *ADHESIVE APPLICATOR FOR USE WITH WSA & WIT ADHESIVES*



The GBAC applies Duro Dyne WIT or WSA water base adhesive to insulation in preparation for application to sheet metal. It requires 110v service fused for 15 amps. A source of air is required. Please specify the direction of work flow when ordering.

**L TO R  
SHOWN**

Item#	Code	Description
39171	GBAC	Roto Bonder w/Circulating Sys. - left to right flow
39250	GBAC	Roto Bonder w/Circulating Sys. - right to left flow

# INSULATION ADHESIVES

## WIT



Water-based Insulation Adhesive specifically designed for Spray, Roller and Brush application. WIT is white in color when applied but dries clear for a clean look. WIT features good wet tack, is non-flammable both in the wet and dry state and is classified by UL (file#R5286). Available in 1 gallon pails, 5 gallon pails and 55 gallon drums.

Item#	Code	Description
5056	WIT1	High Viscosity Water Base Adhesive
5057	WIT5	High Viscosity Water Base Adhesive
5058	WIT55	55 gal High Viscosity Water Base Adhesive

## WITLV-AS / BWITLV-AS



WITLV-AS / BWITLV-AS is a premium, multi-use, water based, non-flammable, UL Classified duct liner and insulation adhesive specifically engineered and formulated for all types of spray, roller, brush or extrusion applications. The LV factor provides a cost effective low viscosity product, with the aim of preventing clogs and providing easy clean up. Airless sprayable and available in white or black.

Item#	Code	Description
5106	WIT5LVAS	WITLV-AS - 5 Gallon Pail - White
5107	WIT50LVAS	WITLV-AS - 50 Gallon Drum - White
5127	BWIT5LVAS	BWITLV-AS - 5 Gallon Pail - Black
5128	BWIT50LVAS	BWITLV-AS - 50 Gallon Drum - Black

# ADHESIVE CANISTERS

Gun and Hose are sold separately.

## PAB40 & PAB187 *DUAL PURPOSE: LINER ADHESIVE & EDGE COATING!*



PAB40 & PAB187 are web type, high solids, general purpose adhesives which bonds well to a wide variety of substrates, with one side or two side applications. This black liner adhesive can also be used as an effective edge coating. It has a quick tack, is flexible, non-wrinkling and waterproof. Use on a variety of surfaces including insulation, plastic, wood, ABS, FRP, foam, carpet, wall coverings, fiberglass, packaging, labeling and more.

Item#	Code	Description
5087	PAB40	Portable Adhesive Canister - Black Solvent Base
5108	PAB187	Portable Adhesive Canister - Black Solvent Base
5097	PAC12H	12 ft. Canister Hose
5098	PAC25H	25 ft. Canister Hose
5099	PAG	Canister Gun with Solvent Base Spray Tip
5101	PAGTS	Replacement Solvent Base Spray Tip
5060	PABT	Edge Coat Spray Tip
5109	PABF	Canister T-Fitting

## PAC40 *LOW VOC & NO METHYLENE CHLORIDE (DICHLORALMETHANE)!*



PAC40 is a web type, high solids, general purpose adhesive which bonds well to a wide variety of substrates, with one side or two side applications. It has a quick tack, is flexible, non-wrinkling and waterproof. Use on a variety of surfaces including insulation, plastic, wood, ABS, FRP, foam, carpet, wall coverings, fiberglass, packaging, labeling and more.

Item#	Code	Description
5094	PAC40	Portable Adhesive Canister - Clear Solvent Base
5097	PAC12H	12 ft. Canister Hose
5098	PAC25H	25 ft. Canister Hose
5099	PAG	Canister Gun with Solvent Base Spray Tip
5101	PAGTS	Replacement Solvent Base Spray Tip
5109	PABF	Canister T-Fitting

## PAW40 *LEED COMPLIANT - NO ODS, NO VOC, NO CHLORINATED SOLVENTS*



PAW40 is an acrylic water based, pressure sensitive adhesive specially formulated for duct liner applications. PAW40 has an aggressive tack, sprays on white and dries clear.

Item#	Code	Description
5091	PAW40	Portable Adhesive Canister - Clear Solvent Base
5097	PAC12H	12 ft. Canister Hose
5098	PAC25H	25 ft. Canister Hose
5099	PAG	Canister Gun with Solvent Base Spray Tip
5100	PAGTW	Water Base Spray Tip
5109	PABF	Canister T-Fitting

# INSULATION CUTTERS

## PLSU2 *AUTOMATIC INSULATION CUTTER FOR USE WITH 1/2 IN. TO 2 IN. LINER*

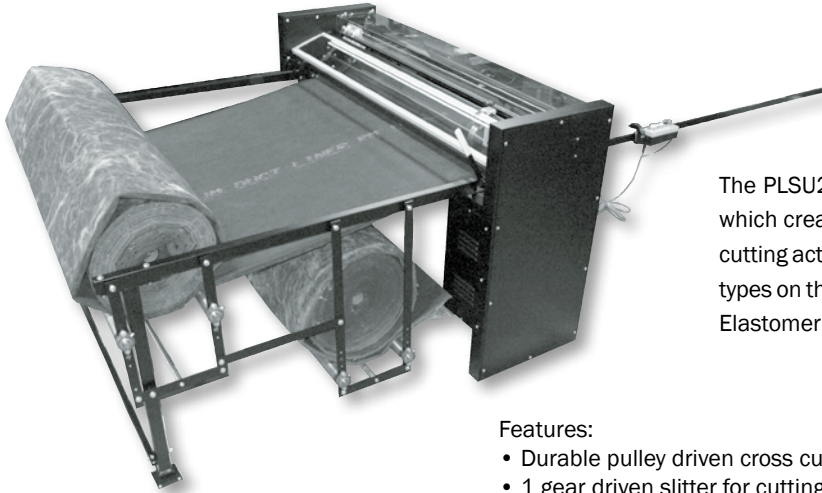

The PLSU2 has a gear driven slitter and a pulley driven cross cut blade which creates a powerhouse to tackle all specialty insulations. This new cutting action will allow the PLSU2 to accommodate virtually all insulation types on the market including closed cell products, cotton fiber, Neoprene, Elastomeric Foam & more.

### Features:

- Durable pulley driven cross cut blade for cutting to length.
- 1 gear driven slitter for cutting various widths. (4 can be added for additional cost).
- An insulation rack is designed to keep liner square and hold up to 2 rolls standard - an additional assembly is also available that can accommodate another 2 rolls.
- Micro switch interlocks on all guards for safety.
- Reliable pneumatic controls.
- Proven 24-volt components for all control circuits.
- Drive rollers of the PLSU2 also run in reverse for easier material loading/unloading.
- Portable controls allow for one machine to work for both 'Left to Right' and 'Right to Left' flows. The PLSU2 can also be manually operated if desired in addition to automatic operation.
- The PLSU2 is built to maintain a tolerance of + or - 1/4" of length desired as well as slitting accurately to desired widths.

Item#	Code	Description
39021	PLSU2	Universal Power Liner Sizer

## LSU *LINER SIZER FOR USE WITH 1/2 IN. TO 2 IN. LINER*



The LSU Advance Liner Sizer will help size and cut duct liner more efficiently than ever thought possible with a hand operated machine. It's enhanced features, make it possible to cut cotton fiber insulations, filter media, rubberized products and other unusual materials. The cross cut and slitter blades are mechanically gear driven to spin while cutting. This spinning action shears the material to create precise cuts in the most difficult of substances.

Item#	Code	Description
28076	LSU	Advanced 5ft. Insulation Cutter w/ 1 Slitting Assembly



# PORTABLE PINSPOTTER MACHINES

## CCD 110 COMPACT PORTABLE PINSPOTTER FOR USE WITH 1/2 IN. - 4 IN. WELD PINS



The CCD110, Capacitor Discharge Welder, is designed for the convenience and comfort of the operator. It is powered by a 110 volt power source so it is ideal for smaller shops and light industrial applications. It will weld pins from 1/2" to 4" long onto steel from 26 to 20 gauge. Its portability on the job, enhanced by its adjustable shoulder strap, makes the CCD110 a smart choice for insulation applications. The CCD110 also features a stud capacity of up to 1/4" steel and stainless steel for enhanced versatility.

Item#	Code	Description
27120	CCD110	Compact Capacitor Discharge Pinspotter 110V

## MF-12A COMPACT PORTABLE PINSPOTTER FOR USE WITH 1/2 IN. - 4 IN. WELD PINS



Special design welding transformers allow the MF12A to deliver more power, precisely timed to the welding tip. The MF-12A will weld pins from 1/2 inch to 4 inches long on steel from 26 to 20 gauge. Proven solid-state weld control circuitry guarantees years of reliable, troublefree service in your shop. Input voltage: 208-230 V 60 HZ single phase. 60 amp service.

Item#	Code	Description
27110	MF12A	Variable Capacity Compact Portable Pinspotter

## PBF-510 HEAVY DUTY PINSPOTTER FOR USE WITH 1/2 IN. TO 2 IN. WELD PINS



The PBF-510 welds BDEP, CTC, SSP, CP, FTC, PN or LN type fasteners to duct work up to 18 gauge. It requires 220 volt, 50 to 60 hz service fused for 100 amps. Place a pin on the magnetic tip, insert the pin through the insulation, give the pin a 1/4 twist and depress the trigger switch. For LN type fasteners use a TPL2 tip. For PN type fasteners use a TP2 tip.

Item#	Code	Description
27372	PBF510	Hi-Capacity Portable Pinspotter

# PINSPOTTER MACHINES

## FG MACH III

### **AUTOMATIC BULK FEED PINSPOTTER WITH FIVE FOOT THROAT**



The FG Mach III Pinspotter was designed utilizing the best of current technologies to provide greater power and reliability for insulation fastening. The inherent minimal material handling and the use of welded pins will insure your shop a cost efficient, quality product. Our upgraded FG Mach III machine is capable of welding pins up to 4" to address the higher R-value insulation now being specified throughout the industry.

- Manual loading track for 3" & 4" pins
- Heavy duty vibrator bowl pins for up to 2"
- Redesigned single transformer for a wider range of welding capabilities
- Wider mouth design for welding up to 4" pins on 4" liner
- Floating upper weld tip assembly for weld cable & weld tip longevity
- Optional lift kit available

Item#	Code	Description
18004	FG MACH III	Wide Mouth, High Capacity Bulk Feed Automatic Pinspotter

## RH MACH III

### **ROLLING HEAD AUTOMATIC PINSPOTTER**



The RH Mach III Pinspotter features a more efficient transformer that provides a wider range of welding capabilities. The Heavy Duty Vibrator Bowl and base weld pins up to 2" and the optional manual feed accommodates pins up to 4" on 4" insulation. A floating upper weld tip and an optional lift kit are among some of the improvements to this Pinspotter. In addition, the RH Mach III features the Rolling Head for easier material handling. The RH Mach III also features a notch on the support bar to easily accommodate TDC/TDF duct. The ability to move the trolley instead of the ductwork minimizes material handling. This feature coupled with utilization of welded pins will insure your shop of a cost efficient, quality product.

- Manual loading track for 3" & 4" pins
- Heavy duty vibrator bowl pins for up to 2"
- Redesigned single transformer for wider range of welding capabilities
- Wider mouth design for welding up to 4" pins on 4" liner
- Floating upper weld tip assembly for weld cable & weld tip longevity
- TDC/TDF notch
- Optional lift kit available

Item#	Code	Description
18005	RH MACH III	Rolling Head Pinspotter TDC/TDF Notch Comes Standard On All Units

# PINSPOTTER MACHINES

## HIGH SPEED MULTIHEAD PINSPOTTER

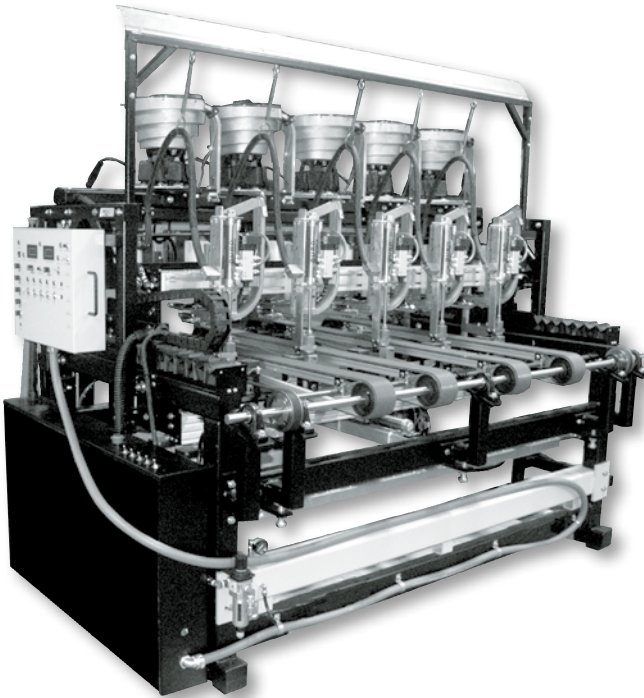

Trouble free service has always been the foundation on which all Duro Dyne Pinspotters are built. All components are designed for easy access for maintenance and service bringing even higher levels of reliability, serviceability and efficiency.

- Full production capacity from ½ inch pins on light gauge material all the way up to 10 foot sheets of 16 gauge material pinned with 2 inch pins at 6 inch centers at 50 feet per minute.
- Newly designed pin feed system accommodating ½ inch to 2-¼ inch pins with no change of bowls required.
- Open Air design that allows operator a full view of material as it passes through the line.
- Ambidextrous Control Console with Umbilical cord allows operation from either side of fabrication line, to accommodate L to R and R to L work flow.
- Non-slip belts & magnetic hold downs to insure positive ground and stability during the weld cycle.
- Fold up gantry to allow easy replenishment of pins.
- Monitor pin level from the floor with the high mount mirror system

Item#	Code	Description
39071	HSMH6	6-Head Unit
39072	HSMH5	5-Head Unit

## MULTIHEAD PINSPOTTER

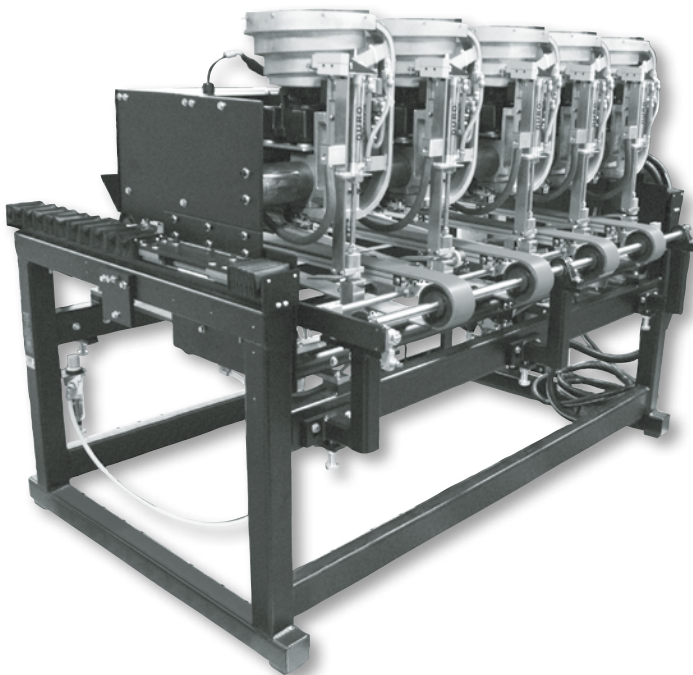

The FGMH Multihead Pinspotter from Duro Dyne will provide maximum fastening quality with minimum maintenance. It is backed with Duro Dyne's 40+ years of pinspotting experience. The Floating carriage design of the FGMH eliminates the need for stopping the material for installation of fasteners and ensures speeds of 40 ft per minute. All Solid state components are easily reachable through simple access panels.

Item#	Code	Description
39073	FGMH6	6-Head Unit
39074	FGMH5	5-Head Unit

**Please Visit Our Website**  
**[www.durodyne.com](http://www.durodyne.com)**  
**for the most current product information.**



© Duro Dyne Corp.  
9/13/16  
BB026403

<b>Duro Dyne East Division, Bay Shore, NY</b>	<b>631-249-9000</b>	<b>Fax: 631-249-8346</b>
<b>Duro Dyne Midwest Division, Hamilton, OH</b>	<b>513-870-6000</b>	<b>Fax: 513-870-6005</b>
<b>Duro Dyne West Division, Fontana, CA</b>	<b>562-926-1774</b>	<b>Fax: 562-926-5778</b>
<b>Duro Dyne Canada, Lachine, Quebec, Canada</b>	<b>514-422-9760</b>	<b>Fax: 514-636-0328</b>

**[www.durodyne.com](http://www.durodyne.com) E-mail: [durodyne@durodyne.com](mailto:durodyne@durodyne.com)**