

# SHOOK

MANUFACTURED PRODUCTS, INC. *Serving the Industry for 50 Years*

*Home of the Original "JIFFY" Chuck*

## FASTENER & TOOL CATALOG

INDUSTRIAL BITS & DRIVERS

2016

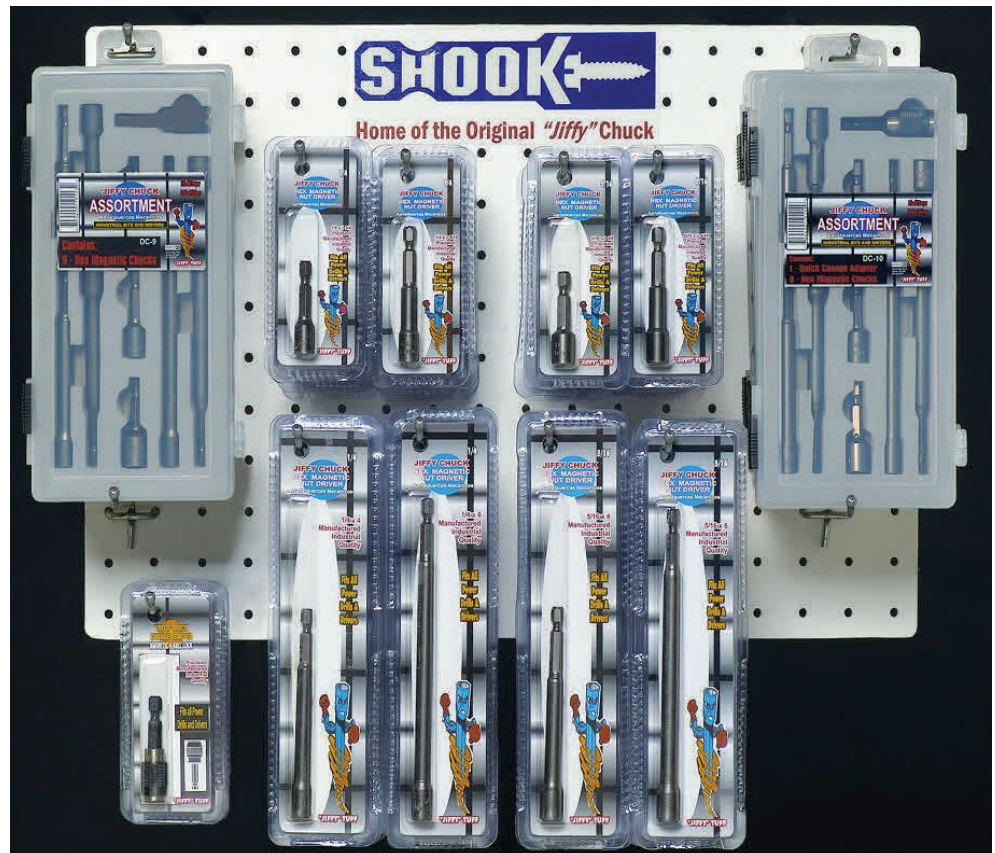

**Bulk, Point-of-Sale, Assortments, Kits, & Private Label**

**Shook Manufactured Products, Inc.**

Phone: (800) 354-9792 - Fax: (800) 733-3882

E-mail: [Shookmfg@earthlink.net](mailto:Shookmfg@earthlink.net)

[www.shookmfg.com](http://www.shookmfg.com)



## Manufactured Products, Inc.

### Distributor Terms and Conditions

Please use barcode numbers to expedite your order processing.

#### Payment Terms:

- Minimum Order: \$ 50.00
- Terms: 2% 15, Net 30
- Unearned discounts will be disallowed
- All orders are subject to acceptance by Shook Manufactured Products, Inc.
- Customers without established credit are requested to submit a credit application and three (3) credit references with first order.

**Prices and availability are subject to change without notice. Prices effect at the time of the order will apply.**

#### Warranty:

Each Shook product carries a limited lifetime warranty. If any tool should break as a result of a manufacturing defect, return it to your place of purchase for repair or replacement. This warranty does not cover damage due to misuse or abuse, tools out of adjustment from use, wear from extensive use, improper use and storage, or any other defect or malfunction of the tool that is other than a manufacturer's defect.

#### Freight Terms:

- No cash discount on freight
- Freight paid on all orders (standard pricing) net \$750.00+
- Freight charges on orders (standard pricing) less than \$750.00 net will be prepaid and added to the invoice

#### Back Orders:

Back orders will be shipped as soon as possible. Back orders from freight paid orders will be shipped freight allowed.

#### Warranty & Returned Goods:

- Shook stands behind all of its products sold
- Returned goods will not be accepted without prior authorization
- Return items must be shipped freight prepaid
- Authorized returns received due to defective workmanship or materials will be repaired, replaced, or credit issued as determined by Shook
- All other approved returns to stock will be assessed a 25% restocking fee

#### Responsibility:

Shook cannot assume responsibility for loss or damage to products in transit. In case of loss, visible, or concealed damage, you, as the consignee, must report such loss or damage to the carrier at once.

**All discrepancies must be noted to Shook within five (5) days of receipt of order.**

#### Credit:

Shipment will be made on open accounts in good standing. No shipments will be made to accounts in arrears.

<b>Billing Address:</b>	PO Box 15058 Akron, OH 44314	<b>Shipping Address:</b>	1017 Kenmore Blvd. Akron, OH 44314
<b>Telephone:</b>	(800) 354-9792	<b>Website:</b>	shookmfg.com
<b>Fax:</b>	(800) 733-3882	<b>E-mail:</b>	shookmfg@earthlink.net



## TABLE OF CONTENTS

### SECTION 1 CHUCKS & BITS

PAGES 3-7	HEX & IMPACT MAGNETIC CHUCKS
PAGE 9	BIT HOLDERS
PAGES 11-14	INSERT & POWER BITS
PAGES 15-16	REFRIGERATION TOOLS & DIGITAL MANIFOLDS
PAGE 9	HEX DRIVE EXTENSIONS

### SECTION 2 FASTENERS & ANCHORING PRODUCTS

PAGES 19-26	JIFFY POINT SCREWS
PAGE 27	SUPER 7 & SUPER 8 JIFFY POINT SCREWS
PAGE 28	PAINTED REGISTER SCREWS
PAGES 29-33	JIFFY DRILTIP SCREWS
PAGE 34-37	TAPPING SCREWS, PAINTED SPEED SCREWS, WOOD SCREWS
PAGES 38-39	DRYWALL, DECK, CONCRETE SCREWS
PAGES 40-41	ANCHORS
PAGES 42-44	BOLTS, NUTS, WASHERS
PAGES 44-45	RIVETS & RIVET TOOLS
PAGE 46	THREADED ROD, ROD CUTTER, COUPLING NUTS
PAGE 47	TOGGLE BOLTS, DRIVE PINS
PAGES 48-51	ANCHOR KITS, FASTENER ASSORTMENTS
PAGES 51-54	DRILL BITS
PAGE 55	HEX CAP SCREWS, BOLTS, LAG SCREWS
PAGES 56-59	VERTIGO & HANGER MATE ROD ANCHORING SYSTEMS

### SECTION 3 HVAC PRODUCTS

PAGES 61-62	WARM AIR DAMPERS, DAMPER HARDWARE & ACCESSORIES
PAGES 63-64	SPECIALTY HVAC/R TOOLS

### SECTION 4 TOOLS

PAGE 66	JIFFY HAND TOOLS
PAGES 67-69	AVIATION SNIPS, SHEET METAL TOOLS, POWER SHEARS
PAGES 72-73	HEX KEYS
PAGE 70	SAW BLADES

### SECTION 5 ELECTRICAL

PAGE 73	JIFFY WIRE NUTS, ELECTRICAL TERMINALS
PAGE 74	JIFFY CABLE TIES, DUCT TIES

### SECTION 6 PLUMBING

PAGE 76	PLUMBER'S CLOTH, THREADED ROD CUTTER
PAGE 77	REMS PIPEWORKING TOOLS, SPECIAL THREADING LUBRICANT
PAGE 78	GLOVES, BRUSHES
PAGE 78	B' LASTER PENETRATING CATALYST, PLASTIC CONTAINERS
PAGE 79	***NEW*** HIGH HEAD SCREWS
PAGE 80	PRIVATE LABEL PROGRAM
PAGE 81-82	INDEX

WELCOME TO  
**SHOOK MANUFACTURED PRODUCTS, INC.**

*Home of the "JIFFY" Chuck!*

WELCOME TO SHOOK MANUFACTURED PRODUCTS INC

SHOOK MANUFACTURED PRODUCTS WAS FOUNDED OVER 50 YEARS AGO BY A MR. QUENTIN SHOOK. QUENTIN, A FORMER CONTRACTOR, TIRED OF BENDING OVER TO PICK UP SHEET METAL SCREWS PERFECTED THE HEX MAGNETIC CHUCK, THE ORIGINAL "JIFFY" CHUCK , A MAGNETIC DRIVER DESIGNED TO HOLD THE SCREWS IN PLACE IN ORDER TO RUN SELF PIERCING AND DRILL-TIP SCREWS. THIS PRECISION MANUFACTURED PRODUCT BOASTS A MACHINE TOOL FINISH AND A STRONG MAGNET IN ADDITION TO EXTREMELY ACCURATE CONCENTRICITY NECESSARY TO ELIMINATE WOBBLE AND A PERFECTLY FLAT SURFACE NECESSARY TO SEAT THE SCREW PROPERLY FOR DRILLING AND DRIVING.

THE SHOOK GUARANTEE OF QUALITY

THE SHOOK JIFFY POINT SCREW IS OUR BEST PERFORMING SHEET METAL SCREW. THE TOOLING AND MANUFACTURING PROCESS IS CLOSELY MONITORED TO INSURE THE PERFORMANCE NECESSARY TO DRILL AND DRIVE SHEET METAL SCREWS WITH SUPERIOR SPEED. IN 2014 SHOOK COMPLETELY OVERHAULED THE JIFFY POINT SCREW WITH IMPROVEMENTS IN RUN TIMES, WIRE HARDNESS AND POINT ANGLE. WE ARE PROUD TO SAY THAT OUR JIFFY POINT SCREW CONTINUES TO INSURE SUPERIOR PERFORMANCE POSITIONING OUR PRODUCT AS AN INDUSTRY LEADING PRODUCT.

THE KEY TO A CONSISTENT UNIFORM PRODUCT IS THE RESULT OF EXTENSIVE QUALITY CHECKS DURING THE MANUFACTURING PROCESS INCLUDING RUN TIME TESTING. AS PART OF OUR QUALITY CONTROL PROCEDURES WE LIMIT THE NUMBER OF SCREWS RUN BETWEEN TOOL CHANGES AND REQUIRE THE SUBMISSION OF RUN SAMPLES PRIOR TO MANUFACTURING OUR PRODUCTS. IN ADDITION TO THAT WE PERIODICALLY EMPLOY AN INDEPENDENT SOURCE FOR ADDITIONAL RUN TIME TESTS TO INSURE THAT OUR CUSTOMERS RECEIVE THE BEST PERFORMING PRODUCT.

RUN TIME TEST DATA IS AVAILABLE UPON REQUEST.

# Section 1

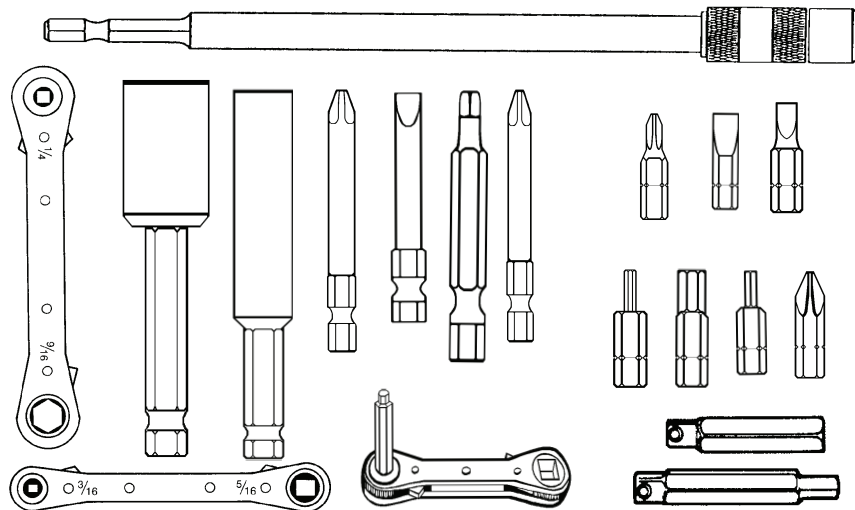

- Chucks
- Bit Holders
- Insert Bits
- Power Bits
- Refrigeration Tools & Bits
- Drive Extensions

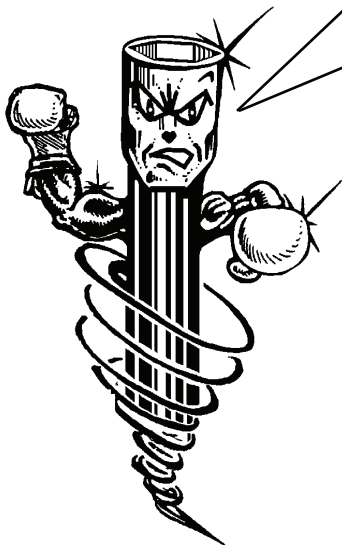

**Hi, Welcome to the All New 2016 Shook Products Catalog.**

I am **Jiffy**, the Fighting Chuck. Throughout this catalog you'll see me. When you do, **BE SURE TO READ WHAT I HAVE TO SAY!**

By the way, did you know that Shook invented the Hex Magnetic Driver, or like we call it, the Jiffy Chuck? That's right! It became known as **The Original Magnetic Jiffy Chuck**. This Superior Quality Tool has been an Industry Benchmark for more than 50 years. Remember, when it comes to "Chucks", ask for the original "Jiffy Chuck"!

## Product Packaging Key

**POS** - Individually packaged for POS (boxed, bagged or carded) for hanging display

**CB** - Counter Bowl (Plastic)

**D** - Multiple Display Card

**HP** - Hang Pack - (Clear Plastic Hang Box or Bag)

**PL** - Plastic Box or Plastic Tub

**J-PK** - Plastic Box

**PB** - Plastic Bucket with Handle

**C** - Chipboard Box

**B** - Bulk Packaged - (Loose - Bagged - Boxed)

**JP** - Jiffy Pail, Handle, & Lid

All Bulk Packaging includes quantity, product description and barcode number

Custom Packaging and Labeling is Available

*The Original Magnetic*  
**Jiffy Chuck**

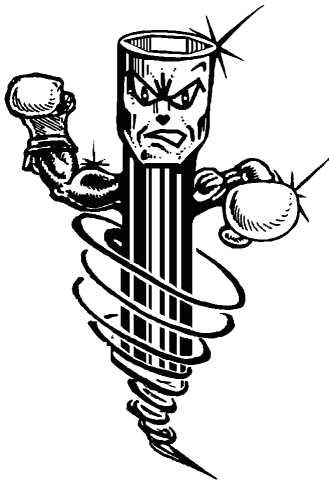

*Industrial Nutdriver*

*Precision Manufactured from Tool Steel for  
Strength and Extended life.*

*Superior Quality Machine Tool Finish*

*Strong Magnet*

*High Concentricity*

*Manufactured to ISO 9000 Standards*

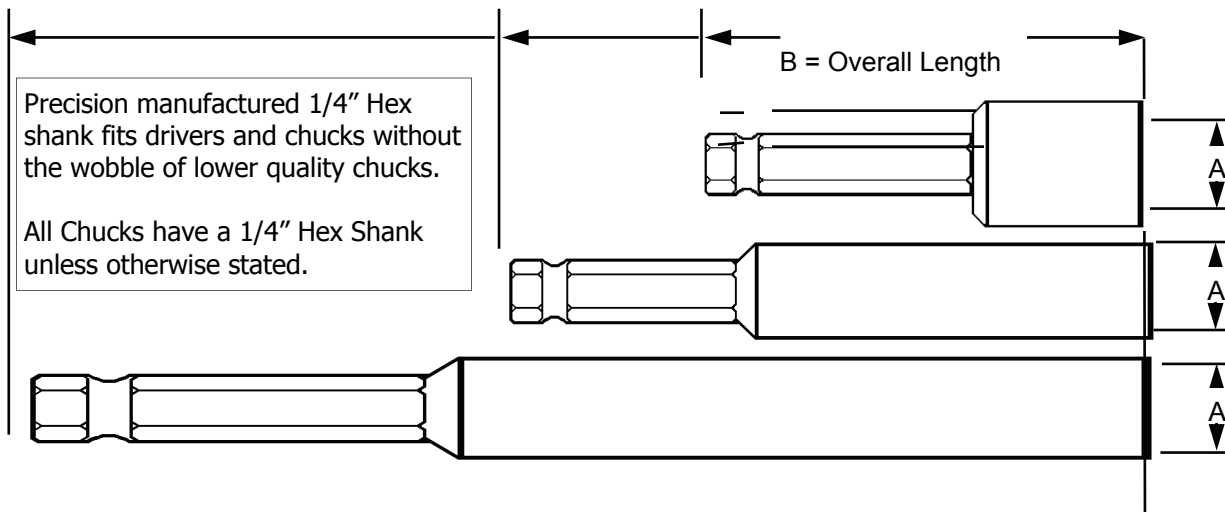

# The Original Magnetic Jiffy Chuck

1/4" Hex Shank **PRECISION MANUFACTURED**

Manufactured to ISO 9000 Standards

1/4" Hex Shank has Rounded Groove for use in Power Drivers - Bit Holders - Power Screwdrivers - Drills

 <p><b>BULK PACK</b></p>	BAR CODE	HEX OPENING	LENGTH	NOSE DIA.	CROSSREFERENCE	PKG. QTY.
	10014	1/4"	1-3/4"	7/16"	MSH 1/4	1
	10001	1/4"	1-3/4"	7/16"	MSH 1/4	100 J-PK
	10003	1/4"	1-3/4"	7/16"	MSH 1/4	500 J-PK
	10044	1/4"	2-9/16"	7/16"	MSHL 1/4	1
	10005	1/4"	2-9/16"	7/16"	MSHL 1/4	100 J-PK
	10007	1/4"	2-9/16"	7/16"	MSHL 1/4	500 J-PK
	***10109	1/4"	4"	7/16"	MSHL 1/4-4	1
	10021	1/4"	4"	7/16"	MSHL 1/4-4	100 J-PK
	10066	1/4"	6"	7/16"	MSHL 1/4-6	1
	10027	1/4"	6"	7/16"	MSHL 1/4-6	100 J-PK
	10020	5/16"	1-3/4"	1/2"	MSH 5/16	1
	10009	5/16"	1-3/4"	1/2"	MSH 5/16	100 J-PK
	10011	5/16"	1-3/4"	1/2"	MSH 5/16	500 J-PK
	10048	5/16"	2-9/16"	1/2"	MSHL 5/16	1
	10013	5/16"	2-9/16"	1/2"	MSHL 5/16	100 J-PK
	10070	5/16"	4"	1/2"	MSHL 5/16-4	1
	10033	5/16"	4"	1/2"	MSHL 5/16-4	50 J-PK
	10074	5/16"	6"	1/2"	MSHL 5/16-6	1
	10035	5/16"	6"	1/2"	MSHL 5/16-6	50 J-PK
10026	3/8"	1-3/4"	9/16"	MSH 3/8	1	
10008	3/8"	1-3/4"	9/16"	MSH 3/8	100 J-PK	
10052	3/8"	2-9/16"	9/16"	MSHL 3/8	1	
10015	3/8"	2-9/16"	9/16"	MSHL 3/8	50 J-PK	
10078	3/8"	4"	9/16"	MSHL 3/8-4	1	
10037	3/8"	4"	9/16"	MSHL 3/8-4	50 J-PK	
10082	3/8"	6"	9/16"	MSHL 3/8-6	1	
10041	3/8"	6"	9/16"	MSHL 3/8-6	50 J-PK	
10032	7/16"	1-7/8"	5/8"	MSH 7/16	1	
10056	7/16"	2-9/16"	5/8"	MSHL 7/16	1	
10038	1/2"	1-7/8"	3/4"	MSH 1/2	1	
10060	1/2"	2-9/16"	3/4"	MSHL 1/2	1	

Note: 10109 was 10062

# The Original Magnetic Jiffy Chuck

Hex Shank **PRECISION MANUFACTURED**

1 PC. HANG PACK

**POINT OF SALE  
PACKAGING**



POS HANG PACK

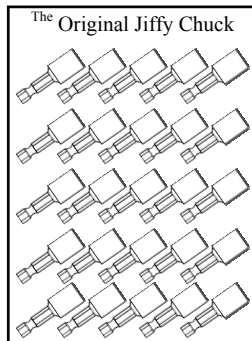

BAR CODE	HEX OPENING	LENGTH	NOSE DIA.	CROSS REFERENCE
10016	1/4"	1-3/4"	7/16"	MSH 1/4
10022	5/16"	1-3/4"	1/2"	MSH 5/16
10028	3/8"	1-3/4"	9/16"	MSH 3/8
10046	1/4"	2-9/16"	7/16"	MSHL 1/4
10050	5/16"	2-9/16"	1/2"	MSHL 5/16
10054	3/8"	2-9/16"	9/16"	MSHL 3/8
10058	7/16"	2-9/16"	5/8"	MSHL 7/16
10061	1/2"	2-9/16"	3/4"	MSHL 1/2
10064	1/4"	4"	7/16"	MSHL 1/4-4
10068	1/4"	6"	7/16"	MSHL 1/4-6
10072	5/16"	4"	1/2"	MSHL 5/16-4
10076	5/16"	6"	1/2"	MSHL 5/16-6
10080	3/8"	4"	9/16"	MSHL 3/8-4
10084	3/8"	6"	9/16"	MSHL 3/8-6

**MULTI-PACK CONTRACTOR JIFFY HANG PACK**

BAR CODE	HEX OPENING	LENGTH	NOSE DIA	PCS	CROSS REFERENCE
10017	1/4"	1-3/4"	7/16"	3	MSH 1/4
10023	5/16"	1-3/4"	1/2"	3	MSH 5/16
10029	3/8"	1-3/4"	9/16"	3	MSH 3/8
10045	1/4"	2-9/16"	7/16"	2	MSHL 1/4
10049	5/16"	2-9/16"	1/2"	2	MSHL 5/16

**25 PC DISPLAY**

BAR CODE	HEX OPENING	LENGTH	NOSE DIA.	CROSS REFERENCE
10018	1/4"	1-3/4"	7/16"	MSH 1/4
10024	5/16"	1-3/4"	1/2"	MSH 5/16
10030	3/8"	1-3/4"	9/16"	MSH 3/8

**100 PIECE COUNTER BOWLS**

10019	1/4"	1-3/4"	7/16"	MSH 1/4
10025	5/16"	1-3/4"	1/2"	MSH 5/16
10031	3/8"	1-3/4"	9/16"	MSH 3/8
10047	1/4"	2-9/16"	7/16"	MSHL 1/4
10051	5/16"	2-9/16"	1/2"	MSHL 5/16
10055	3/8"	2-9/16"	9/16"	MSHL 3/8



# The Original Magnetic JIFFY GRIP Chuck

## For IMPACT Drills & Standard Drills

The **lobular** design reduces stress and significantly increases strength.

New **stronger** magnet holds ferrous screws better. Provides exceptional performance.

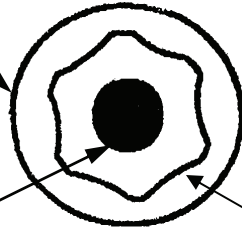

*Precision Manufactured to ISO 9000 Standards-Industrial Quality*

**Lobular** socket design drives screws on the flats, preventing rounding. Also helps protect the finished screw heads.



POINT OF SALE PACKAGING

### 1 PC. POS HANG PACK

BAR CODE	HEX OPENING	LENGTH	NOSE DIA.	CROSS REFERENCE
10222	1/4"	1-3/4"	7/16"	MSH 1/4
10228	5/16"	1-3/4"	1/2"	MSH 5/16
10232	3/8"	1-3/4"	9/16"	MSH 3/8
10053	1/4", 5/16", & 3/8"	1-3/4"		

1/4x2-9/16, 5/16x2-9/16, 3/8x2-9/16 available by request, please contact factory.

### BULK PACK

BAR CODE	HEX OPENING	LENGTH	NOSE DIA.	CROSS REFERENCE
10220	1/4"	1-3/4"	7/16"	MSH 1/4
10240	1/4"	2-9/16"	7/16"	MSHL 1/4
10226	5/16"	1-3/4"	1/2"	MSH 5/16
10244	5/16"	2-9/16"	1/2"	MSHL 5/16

## **Precision Manufactured HEX MAGNETIC Jiffy Chucks**

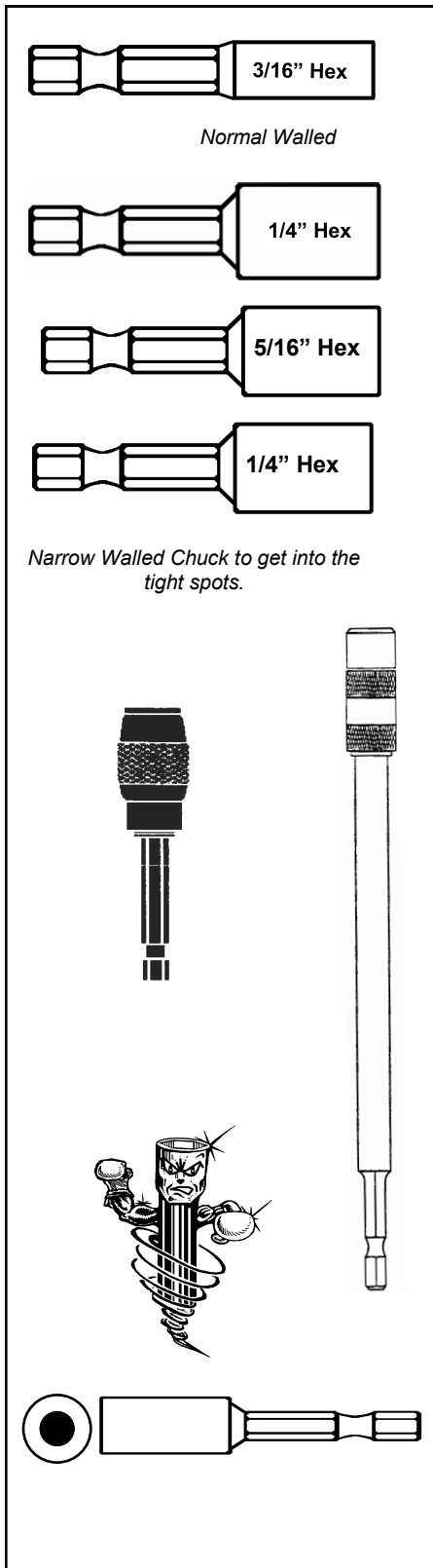

Bar Code Number	Item Description	Size A x B	Package Quantity
10040	3/16" x 2-9/16" 100-B		1 Bulk
10069	1/4" x 8"		1 Bulk
10101	1/4" x 8"		1 POS
10071	1/4" x 12"		1 Bulk
10073	5/16" x 8"		1 Bulk
10075	5/16" x 12"		1 Bulk
10036	7/16" x 6"		1 Bulk
<b>REDUCED HEAD</b>			
10106	1/4 x 1-5/8"		1 Bulk
10108	1/4" x 1-5/8"		1 POS
<b>TAPERED HEAD</b>			
10102	1/4 x 1-5/8"		1 Bulk
10104	1/4 x 1-5/8"		1 POS

### **JIFFY QUICK CHANGE CHUCK ADAPTERS**

10575	Jiffy Quick Change Chuck Adapter 1/4 x 2" with Magnet & Ball Lock for use with 1/4" Hex Insert Bits & Power Bits.	1 POS
10576	Jiffy Quick Change Chuck Adapter 1/4 x 2" with Magnet & Ball Lock for 25 Pc Counter Bowl use with 1/4" Hex Insert Bits & Power Bits.	1 POS
10043	Jiffy Quick Change Chuck Adapter 1/4 x 2" with Magnet & Ball Lock for use with 1/4" Hex Insert Bits & Power Bits.	100 J-PK

### **Jiffy Quick Change Power Extension**

**1/4" Hex Shank with Torque Groove.  
Quick Change Snap Chuck Holds 1/4 Hex Insert & Power Bits**

10572	Jiffy Quick Change Extension - 6"	1 POS
10574	Jiffy Quick Change Extension - 10"	1 POS

### **Hanger Bolt Drivers**

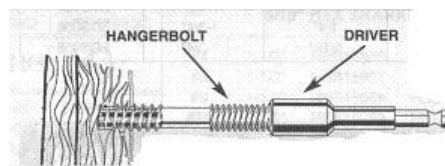

10292	Jiffy Hanger Bolt Driver - 5/16-18 x 2-9/16"	1 Bulk
10286	Jiffy Hanger Bolt Driver - 3/8-16 x 1-3/4"	1 Bulk

# The Original Magnetic Jiffy Chuck MULTI-PIECE KITS

Bar Code	Item Description	Display Qty
10114	<b>Kit Part # DC10</b> Contains an assortment of 9 Original Jiffy Magnetic Chucks in a plastic storage box - Contains 1 ea. Of 1/4"x1-3/4", 1/4"x2-9/16", 1/4"x4", 1/4"x6", 5/16"x1-3/4", 5/16"x2-9/16", 5/16"x4", 5/16"x6", 3/8"x1-3/4", and a quick change adapter.	1 Kit
10113	<b>Kit Part # DC9</b> Contains an assortment of 9 Original Jiffy Magnetic Chucks in a plastic storage box - Contains 1 ea. Of 1/4"x1-3/4", 1/4"x2-9/16", 1/4"x4", 1/4"x6", 5/16"x1-3/4", 5/16"x2-9/16", 5/16"x4", 5/16"x6", 3/8"x1-3/4"	1Kit
10120	<b>Kit Part # DC-4XL</b> Contains an assortment of Original Jiffy Magnetic Chucks in a plastic storage box - Contains 1 ea. Of 1/4" x 6", 5/16" x 6", 3/8" x 6", 7/16" x 6", and a quick change adapter.	1 Kit
10122	<b>Kit Part # DC-5L</b> Contains an assortment of Original Jiffy Magnetic Chucks in a plastic storage box - Contains 1 ea. Of 1/4" x 2-9/16", 5/16" x 2-9/16", 3/8" x 2-9/16", 7/16" x 2-9/16", 1/2" x 2-9/16", and a quick change adapter.	1 Kit
10178	<b>Kit Part # DC-6</b> Contains 1 ea-1/4", 5/16", 3/8" x 1-3/4', 1 ea. 7/16", 9/16", 1/2" x 1-7/8"	1 Kit
12652	<b>Kit Part # DC-3S</b> Contains 1 ea. 1/4", 5/16", 3/8" short Jiffy Chucks	1 Kit
12654	<b>Kit Part# DC-3L</b> Contains 1 ea. 1/4", 5/16", 3/8" Long Jiffy Chucks	1 Kit
12656	<b>Kit Part# DC-MBH</b> Contains 1- 1/4" Mag. Bit Holder, 1 ea- # 1,2,3 Phillips Insert Bit, 1 ea- # 4, 6, 8 Slotted Insert Bit	1 Kit



**SHOOK**

Home of the Original "Jiffy" Chuck

## HEX MAGNETIC NUT DRIVERS

Sizes: 1/4x1-3/4, 1/4x2-9/16, 1/4x4, 1/4x6, 5/16x1-3/4, 5/16x2-9/16, 5/16x4, 5/16x6, 3/8x1-3/4 with Quick Change Adapter

**Fits all Power Drills & Drivers**

Model DC10

Barcode #10114

SHOOK MFG. PRODUCTS, INC.  
AKRON, OH (800) 354-9792  
www.SHOOKMFG.COM



# “Jiffy” Magnetic Nutdrivers & Screwdrivers

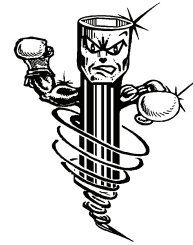
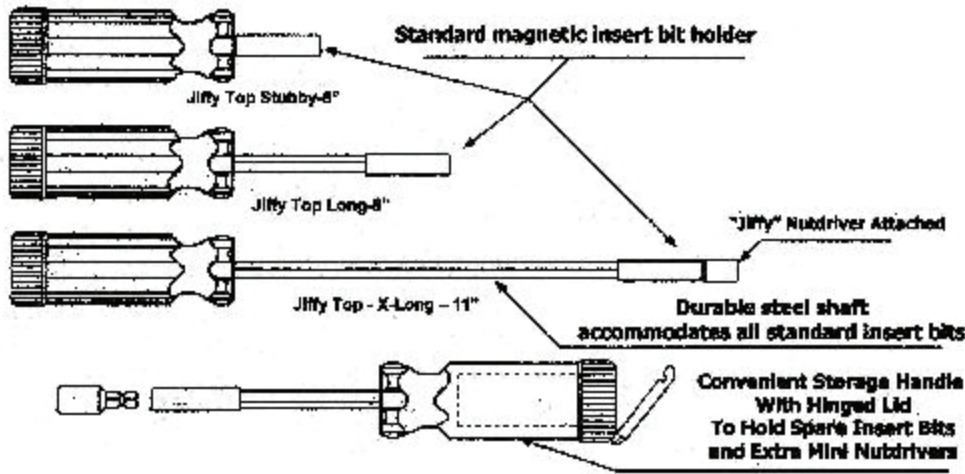

### Magnetic Screwdrivers (No bits included)

Bar Code Number	Item Description	Size	Length	Pkg. Qty.
08002	Jiffy Top Stubby		3"	1 Bulk
08004	Jiffy Top Stubby W/ Storage		5"	1 Bulk
08008	Jiffy Top Long W/ Storage		8"	1 Bulk
08028	Jiffy Top X-Long W/ Storage		11"	1 Bulk

### Magnetic Screwdrivers with Hex Magnetic Jiffy Chucks

Bar Code Number	Item Description	Size	Length	Pkg. Qty.
08357	Jiffy Top Stubby w 1/4 & 5/16 Chuck		5"	1
08365	Jiffy Top Long w 1/4 & 5/16 Chuck		8"	1
08373	Jiffy Top X-Long w 1/4 & 5/16 Chuck		11"	1

### Magnetic Screwdrivers with Insert Bits

Bar Code Number	Item Description	Size	Length	Pkg. Qty.
08064	Jiffy Top Stubby W/ # 1, 2, 2R, 3 Phillips Bits		5"	1
08068	Jiffy Top Long W/ # 1, 2, 2R, 3 Phillips Bits		8"	1
08084	Jiffy Top X-Long W/ # 1, 2, 2R, 3 Phillips Bits		11"	1
08097	Jiffy Top Stubby 1/8, 5/32, & 3/16 Hex Bits		5"	1
08098	Jiffy Top Long 1/8, 5/32, & 3/16 Hex Bits		8"	1
08099	Jiffy Top X-Long 1/8, 5/32, & 3/16 Hex Bits		11"	1

**NOTE:** Please use bar code numbers to speed your order processing.

# Jiffy Magnetic Bit Holders

1/4" Hex Shank - For use with 1/4" Insert Bits

Check It Out! Quality NO Other Bit Holders Can Match!

1/4" Hex Shank with Power Groove. Cold Formed for Harder, Denser, more Durable Shank!

Tool Grade Steel for Superior Quality and Corrosion Resistance. Specifications Guaranteed to +/- .001"

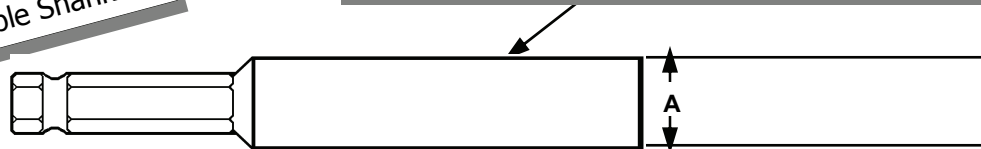

A = Hex Opening Size

Magnetic & C-Ring Positive Locking Retainer Clip for Extra Holding Power!



**POWERFUL MAGNETS!**

Jiffy Magnetic Bit Holders use Large Powerful Magnets that give HOLDING POWER!

Insert Bit Holder - 7/16" Body Dia., 7/16" Nose dia.

10312	Jiffy C-Ring Bit Holder - 6"	1 Bulk
-------	------------------------------	--------

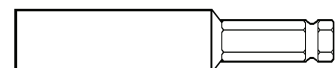

10370	Jiffy Telescoping Screw Guide	1 POS
-------	-------------------------------	-------



Supports Long Screws For Easier Starting & Driving

## Jiffy Hex Drive Extensions

1/4" Hex Drive - Male Square

Bar Code Number	Item Description	Length Inches	Male Square	Package Quantity
09602	1/4" Hex Drive Extension	2"	1/4"	1 POS
09604	1/4" Hex Drive Extension	3"	1/4"	1 POS

Durable Pin Lock

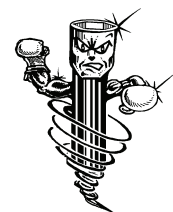

1/4" Hex Shank

**NOTE: Insert Bits are 1" in length unless otherwise stated**

## Jiffy Phillips Tip Insert Bits

**1/4" Hex Shank x 1" Long - has Retaining Groove for use in Bit Holders and Screwdrivers**

Bar Code Number	Item Description	Size	Package Quantity
10402	Phillips Insert Bit- #1		1 Bulk
10380	Phillips Insert Bit- #1		10 J-Pack
10413	Phillips Insert Bit - #1		25 J-Pack
10406	Phillips Insert Bit - #2		1 Bulk
10381	Phillips Insert Bit- # 2		10 J-Pack
09564	Phillips Insert Bit - #2		25 Display
10472	Phillips Insert Bit - #2		25 J-Pack
10473	Phillips Insert Bit - #2		100 J-Pack
10407	Phillips Insert Bit - #2		100 CB
10408	Phillips Insert Bit # 2 Reduced Diameter		1 Bulk
09566	Phillips Insert Bit - #2 Reduced Diameter		25 Display
10374	Phillips Insert Bit - #2 Reduced Diameter		25 J-Pack
10375	Phillips Insert Bit - #2 Reduced Diameter		100 J-Pack
10410	Phillips Insert Bit - #3		1 Bulk
10371	Phillips Insert Bit - #3		25 J-Pack
10372	Phillips Insert Bit - #3		100 J-Pack

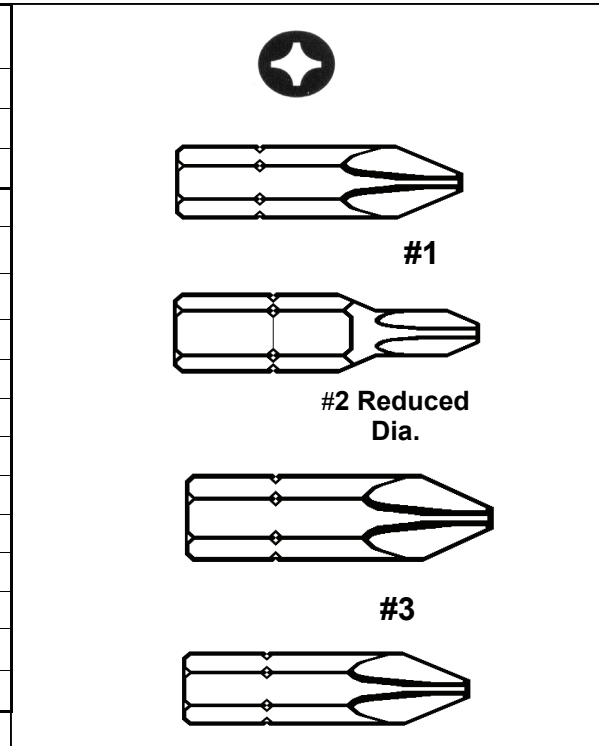

**1/4" Hex Shank - has Retaining Groove for use in Bit Holders and Screwdrivers**

10373	Phillips Insert Bit - #2 x 1-1/2" Long	3 J-Pack
10412	Phillips Insert Bit - #2- 1-1/2" Long	1 Bulk

## Jiffy Phillips Tip Insert Bits ACR Style

**1/4" Hex Shank x 1" Long - has Retaining Groove for use in Bit Holders and Screwdrivers**

Bar Code Number	Item Description	Size	Package Quantity
10376	Phillips ACR Bit #1		10 J-Pack
10377	Phillips ACR Bit #2		10 J-Pack
10378	Phillips ACR Bit #2 Reduced Dia.		10 J-Pack
10379	#3 Phillips ACR Bit		10 J-Pack

**ACR®:** The interlocking ribs of the ACR anti-cam-out system provide higher torque.

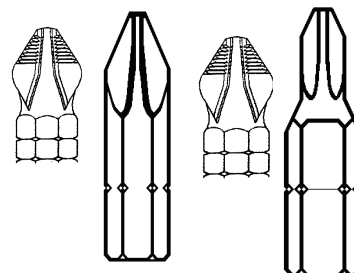

**NOTE: Insert Bits are 1" in length unless otherwise stated**

**1/4" Hex Shank**

## Jiffy Slotted (Flat Tip) Insert Bits

1/4" Hex Shank x 1" Long - has Retaining Groove for use in Bit Holders and Screwdrivers

Bar Code Number	Item Description	Package Quantity
10383	#8F-10R Slotted Insert Bit	10 J-Pack
10384	#10F-12R Slotted Insert Bit	10 J-Pack
10385	#12F-14R Slotted Insert Bit	10 J-Pack



## Jiffy Hex Drive Insert Bits

1/4" Hex Shank x 1" Long - has Retaining Groove for use in Bit Holders and Screwdrivers

Bar Code Number	Item Description	Size	Package Quantity
09415	Jiffy Hex Drive Insert Bit - 1/8"		10 J-Pack
10386	Jiffy Hex Drive Insert Bit - 5/32"		10 J-Pack
10387	Jiffy Hex Drive Insert Bit - 3/16"		10 J-Pack
10388	Jiffy Hex Drive Insert Bit - 1/4"		10 J-Pack

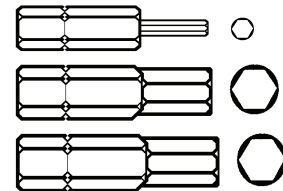

## Jiffy Tamper Resistant Hex Insert Bits

1/4" Hex Shank x 1" Long - has Retaining Groove for use in Bit Holders and Screwdrivers

10389	Jiffy Tamper Resist. Hex Insert Bit - 3/32"	10 J-Pack
10390	Jiffy Tamper Resist. Hex Insert Bit - 1/8"	10 J-Pack
10391	Jiffy Tamper Resist. Hex Insert Bit - 5/32"	10 J-Pack
10392	Jiffy Tamper Resist. Hex Insert Bit - 3/16"	10 J-Pack
10393	Jiffy Tamper Resist. Hex Insert Bit - 7/32"	10 J-Pack
10394	Jiffy Tamper Resist. Hex Insert Bit - 5/16"	10 J-Pack

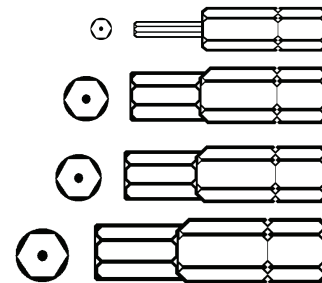

## Jiffy Spanner Insert Bits

1/4" Hex Shank x 1" Long - has Retaining Groove for use in Bit Holders and Screwdrivers

09401	Jiffy Spanner Insert Bit - #6	10 J-PK
09403	Jiffy Spanner Insert Bit - #8	10 J-PK
09405	Jiffy Spanner Insert Bit - #10	10 J-PK
09407	Jiffy Spanner Insert Bit - #12	10 J-PK
09409	Jiffy Spanner Insert Bit - #14	10 J-PK
09413	Jiffy Spanner Insert Bit—#14 x 1-1/2" 5/16" Drive	10 J-PK

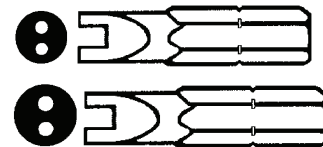

Cold formed for optimum toughness and resistance to wear.  
Security fastener system.  
Insert style only.  
Medium hard only.

**NOTE: Insert Bits are 1" in length unless otherwise stated**

# Jiffy Star Insert Bits

**1/4" Hex Shank x 1" Long - has Retaining Groove for use in Bit Holders and Screwdrivers**

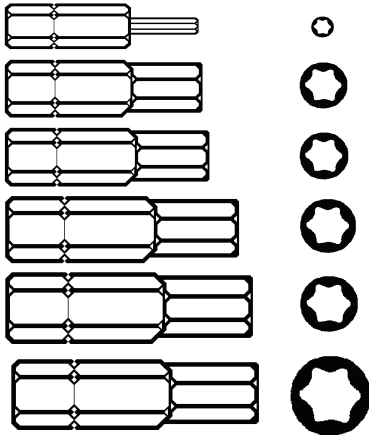

Bar Code Number	Item Description	Size	Package Quantity
10395	Jiffy Star Insert Bit - # T7		10 J-PK
10169	Jiffy Star Insert Bit - # T8		10 J-PK
10170	Jiffy Star Insert Bit - # T9		10 J-PK
10396	Jiffy Star Insert Bit - # T10		10 J-PK
10397	Jiffy Star Insert Bit - # T15		10 J-PK
10398	Jiffy Star Insert Bit - # T20		10 J-PK
10399	Jiffy Star Insert Bit - # T25		10 J-PK
10130	Jiffy Star Insert Bit - # T25		100 J-PK
10131	Jiffy Star Insert Bit - # T27		10 J-PK
10132	Jiffy Star Insert Bit - # T30		10 J-PK
10133	Jiffy Star Insert Bit - # T40		10 J-PK
10134	Jiffy Star Insert Bit 5/16" Hex # 5T45		10 J-PK
10135	Jiffy Star Insert Bit 5/16" Hex # 5T55		10 J-PK

## Jiffy Tamper Resistant Star Insert Bits

**1/4" Hex Shank**

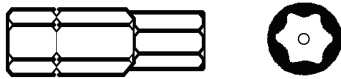

Bar Code Number	Item Description	Size	Package Quantity
10136	Jiffy Tamper Resistant Star Insert Bit - # TR10		10 J-PK
10137	Jiffy Tamper Resistant Star Insert Bit - # TR27		10 J-PK
10138	Jiffy Tamper Resistant Star Insert Bit - # TR30		10 J-PK

## Jiffy Hex Insert Bit Kits

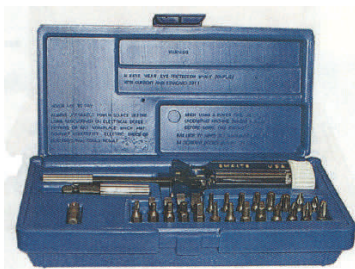

Bar Code Number	Item Description	Size	Pkg. Qty.
09550	<b>Jiffy 30 Piece Bit Kit includes ...</b> Jiffy Top Storage Handle Magnetic Screwdriver Slotted Insert Bits: 0-1, 3-4, 5-6, 8-10, 12 Phillips Insert Bits: #0, #1, #2, #3 Hex Insert Bits: 5/64, 3/32, 1/8, 9/64 Square Insert Bits: #0, #1, #2, #3 Posidriv® Insert Bits: #1, #2 Torx Insert Bits: T10, T15, T20, T25, T30, T40 1/4" Socket Adapter, Plastic Carrying Case		1 Set
09552	<b>Jiffy 30 Piece Security Bit Kit includes ...</b> Jiffy Top Storage Handle Magnetic Screwdriver 1/4" Bit Holder, 1/4" Square & 1/4" Hex Male Adapter Tamper Resistant Phillips Insert Bit: #2 Tamper Resistant Spanner Insert Bits: #4, #6, #8, #10, #12, #14 Tamper Resistant Hex Insert Bits: 3/32, 1/8, 9/64, 5/32, 3/16, 7/32, 1/4, 2.5mm, 3mm, 5mm Tamper Resistant Torx Insert Bits: T8, T9, T10, T15, T20, T25, T27, T30, T40 Plastic Carrying Case		1 Set



## JiffyDrive Recess Square Insert Bits

1/4" Hex Shank X 1" Long - has Retaining Groove for use in Bit Holders and Screwdrivers

Cold formed for optimum toughness and resistance to wear.

Popular in mobile homes, recreation vehicles, and some furniture.

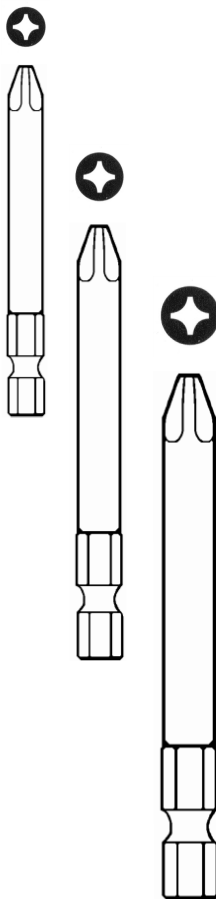

Bar Code Number	Item Description	Size	Package Quantity
10380	Jiffy Square Drive Recess Bit - #1		10 J-Pack
10381	Jiffy Square Drive Recess Bit - #2		10 J-Pack
10382	Jiffy Square Drive Recess Bit - #3		10 J-Pack

## Jiffy Phillips Tip Power Bits

1/4" Hex Shank x 1-15/16" Long - Has Torque Groove for Use in Power Drivers and Drills

Bar Code Number	Item Description	Size	Package Quantity
10123	Jiffy Phillips Power Bit - #1 Phillips x 1-15/16"		3 J-PK POS
10124	Jiffy Phillips Power Bit - #1 Phillips x 1-15/16"		10 J-PK POS
10125	Jiffy Phillips Power Bit - #1 Phillips x 1-15/16"		100 J-Pack
10480	Jiffy Phillips Power Bit - #2 Phillips x 1-15/16" - 200-P2		1 Bulk
10126	Jiffy Phillips Power Bit - #2 Phillips x 1-15/16"		3 J-PK POS
10127	Jiffy Phillips Power Bit - #2 Phillips x 1-15/16"		10 J-PK POS
10482	Jiffy Phillips Power Bit - #2 Phillips x 1-15/16" - 200-P2-D		25 Display
10483	Jiffy Phillips Power Bit - #2 Phillips x 1-15/16" - 200-P2		100 CB
10128	Jiffy Phillips Power Bit - #2 Phillips x 1-15/16"		100 J-Pack
10484	Jiffy Phillips Power Bit - #3 Phillips x 1-15/16" - 200-P3		1 Bulk
10129	Jiffy Phillips Power Bit - #3 Phillips x 1-15/16"		3 J-PK POS
10139	Jiffy Phillips Power Bit - #3 Phillips x 1-15/16"		10 J-PK POS
10140	Jiffy Phillips Power Bit - #3 Phillips x 1-15/16"		100 J-Pack
10488	Jiffy Phillips Power Bit - #1 Phillips x 2-3/4" - 275-P1		1 Bulk
10141	Jiffy Phillips Power Bit - #1 Phillips x 2-3/4"		3 J-PK POS
10142	Jiffy Phillips Power Bit - #1 Phillips x 2-3/4"		10 J-PK POS
10143	Jiffy Phillips Power Bit - #1 Phillips x 2-3/4"		100 J-Pack
10490	Jiffy Phillips Power Bit - #2 Phillips x 2-3/4" - 275-P2		1 Bulk
10144	Jiffy Phillips Power Bit - #2 Phillips x 2-3/4"		3 J-PK POS
10145	Jiffy Phillips Power Bit - #2 Phillips x 2-3/4"		10 J-PK POS
10146	Jiffy Phillips Power Bit - #2 Phillips x 2-3/4"		100 J-Pack
10492	Jiffy Phillips Power Bit - #3 Phillips x 2-3/4" - 275-P3		1 Bulk
10147	Jiffy Phillips Power Bit - #3 Phillips x 2-3/4"		3 J-PK POS
10148	Jiffy Phillips Power Bit - #3 Phillips x 2-3/4"		10 J-PK POS
10149	Jiffy Phillips Power Bit - #3 Phillips x 2-3/4"		100 J-Pack
10150	Jiffy Phillips Power Bit - #1 Phillips x 3-1/2"		3 J-PK POS
10151	Jiffy Phillips Power Bit - #2 Phillips x 3-1/2"		3 J-PK POS
10152	Jiffy Phillips Power Bit - #3 Phillips x 3-1/2"		3 J-PK POS
10500	Jiffy Phillips Power Bit - #1 Phillips x 6" - 600-P1		1 Bulk
10502	Jiffy Phillips Power Bit - #2 Phillips x 6" - 600-P2		1 Bulk
10504	Jiffy Phillips Power Bit - #3 Phillips x 6" - 600-P3		1 Bulk

## Jiffy Square Drive Recess Power Bits

1/4" Hex Shank x 1-15/16" Long - Has Torque Groove for Use in Power Drivers and Drills

Bar Code Number	Item Description	Size	Package Quantity
10156	Jiffy Square Drive Power Bit	#1 x 1-15/16"	3 J-PK POS
10157	Jiffy Square Drive Power Bit	#2 x 1-15/16"	3 J-PK POS
10158	Jiffy Square Drive Power Bit	#3 x 1-15/16"	3 J-PK POS
10159	Jiffy Square Drive Power Bit	#1 x 2-3/4"	3 J-PK POS
10160	Jiffy Square Drive Power Bit	#2 x 2-3/4"	3 J-PK POS
10171	Jiffy Square Drive Power Bit	#2 x 2-3/4"	10 J-PK POS
10161	Jiffy Square Drive Power Bit	#3 x 2-3/4"	3 J-PK POS

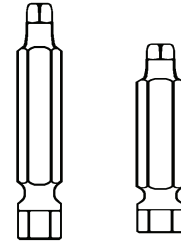

## Jiffy Star Tip Power Bits

1/4" Hex Shank x 1-15/16" Long - Has Torque Groove for Use in Power Drivers and Drills

Bar Code Number	Item Description	Size	Package Quantity
10162	Jiffy Star Power Bit	#T10	3 J-PK POS
10163	Jiffy Star Power Bit	#T 15	3 J-PK POS
16164	Jiffy Star Power Bit	#T 20	3 J-PK POS
10165	Jiffy Star Power Bit	#T 25	3 J-PK POS
10166	Jiffy Star Power Bit	#T 30	3 J-PK POS

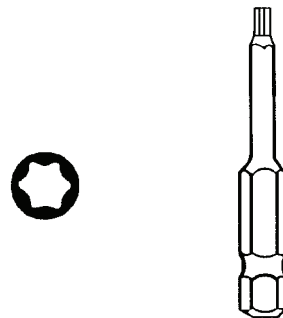

## Clutch G Style Power Bits

1/4" Hex Shank x 1-15/16" Long - Has Torque Groove for Use in Power Drivers and Drills

10167	Clutch G Power Bit - 5/32" x 1-15/16"	3 J-PK POS
-------	---------------------------------------	------------

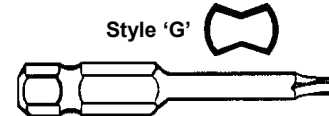

## Jiffy Power Bits for Posidriv® Fasteners

1/4" Hex Shank x 1-15/16" Long - Has Torque Groove for Use in Power Drivers and Drills

Bar Code Number	Item Description	Package Quantity
10172	Power Bit - Posidriv® #1 Tip x 1-15/16"	3 J-PK POS
10173	Power Bit - Posidriv® #2 Tip x 1-15/16"	3 J-PK POS
10174	Power Bit - Posidriv® #3 Tip x 1-15/16"	3 J-PK POS

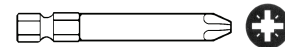

## Jiffy Slotted (Flat Tip) Power Bits

1/4" Hex Shank x 1-15/16" Long - has Torque Groove for use in Power Drivers and Drills

Bar Code Number	Item Description	Size	Package Quantity
10175	Jiffy Slotted Power Bit - # 4F - 5R Slotted - 20-4S		3 J-PK POS
10176	Jiffy Slotted Power Bit - # 5F - 6R Slotted - 20-6S		3 J-PK POS
10177	Jiffy Slotted Power Bit - # 6F - 7R Slotted - 20-7S		3 J-PK POS
10179	Jiffy Slotted Power Bit - # 8F-10R Slotted - 20-8S		3 J-PK POS
10180	Jiffy Slotted Power Bit-# 12F-14R Slotted -20-10S		3 J-PK POS

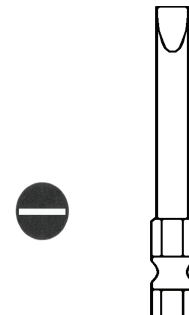

# Jiffy Air Conditioning & Refrigeration Tools

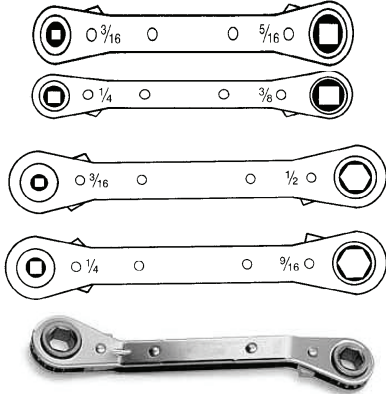

Bar Code Number	Item Description	Size	Package Quantity
10556	Jiffy Refrigeration Ratcheting Tool - 5-7/32" Long - 3/8" & 5/16" Square Drive and 1/4" & 3/16" Square Drive Combos		1 POS
10554	Jiffy Refrigeration Ratcheting Tool - 7" Long - 1/4" & 3/16" Sq. Drive and 9/16" & 1/2" Hex Drive Combos		1 POS
10555	Jiffy Offset Refrigeration Ratcheting Tool - 5-7/32" Long- 3/8" & 5/16" Square Drive and 1/4" & 3/16" Square Drive Combos		1 POS
10567	Jiffy 2 Pc. Refrigeration Svc. Kit - (1 ea 10550, 10556)		1 POS

## Jiffy Refrigeration Tool Hex Key Insert Bits

1/4" Hex Shank



10550	Jiffy HVACR Hex Bit - 3/16" Hex	1 POS
10569	Jiffy HVACR Hex Bit - 3/16" Hex	100 CB
10551	Jiffy HVACR Hex Bit - 5/16" Hex	1 POS
10573	Jiffy HVACR Hex Bit - 5/16" Hex	100 CB
10549	Jiffy Hex Bit Set- 1 ea. 3/16" & 5/16"	1 POS

## Jiffy Refrigeration Service Tool Kit

BAR CODE	ITEM DESCRIPTION
10557	<p><b>REFRIGERATION SERVICE TOOL KIT</b>                      KIT INCLUDES: 5-7/32" LONG STRAIGHT COMBO-END SQUARE DRIVE 3/16"-5/16", 1/4"-3/16"</p> <p>7" LONG COMBO END SQUARE DRIVE                      3/16"-5/16", 1-4"-3/16"</p> <p>3/16" HEX REFRIGERATION INSERT BIT</p> <p>5/16" HEX REFRIGERATION INSERT BIT</p>



**Go DIGITAL!**

# AK-900

## DIGI-COOL Refrigeration Analyzer

*The next stage  
in digital HVAC  
evolution*



***Manifold Included***

- Advanced LCD screen
- Durable design with bar graph display
- Accuracy within +/- 0.5%
- 30+ common refrigeration profiles on-board
- Superheat & supercool accessible on single screen
- User-friendly real time updates
- Charge A/C systems faster
- Comes with a "Reeferman Red" boot

### ACCESSORIES AVAILABLE FOR DRSA 1100, 1200, 1600

TB-1120 Bar Clamp



TS-1120 Scissor Clamp



**THE ORIGINAL "JIFFY" CHUCK -  
POINT OF SALE PROGRAM**

Free Peg Board Planogram Display  
(including hooks)

QUANTITY	BARCODE #	SIZE
12	10016	1/4X1-3/4
12	10022	5/16X1-3/4
6	10046	1/4X2-9/16
6	10050	5/16X2-9/16
6	10064	1/4X4
6	10072	5/16X4
6	10068	1/4X6
6	10076	5/16X6
6	10114	DC10 ASSORTMENT
6	10113	DC9 ASSORTMENT
6	10575	QUICK CHANGE ADAPTER
1	10116	PLANOGRAM DISPLAY



**REFRIGERATION SERVICE TOOLS  
ASSORTMENT**

QUANTITY	BAR-CODE #	DESCRIPTION
6	10557	4 PIECE SERVICE TOOL KITS - Includes #10554, #10556, #10550, #10551
6	10567	2 PIECE SERVICE TOOL KITS - Includes #10556, #10550
6	10556	COMBO RATCHET TOOL - Includes: 5-7/32 Long-Sq Drive 3/8 & 5/16 & 1/4 & 3/8
6	10554	COMBO RATCHET TOOL - Includes: 7 Long Hex Drive 1/4 & 3/16 & 9/16 & 1/2
6	10555	OFFSET COMBO RATCHET TOOL - Includes: 5-7/32L Sq Drive 3/8 & 5/16 & 1/4 & 3/16
12	10550	3/16 REFRIGERATION HEX INSERT BIT
6	10551	5/16 REFRIGERATION HEX INSERT BIT
48	10510	COMPLETE PLANOGRAM COMES COMPLETE WITH DISPLAY BOARD AND HOOKS AT NO CHARGE



# Section 22

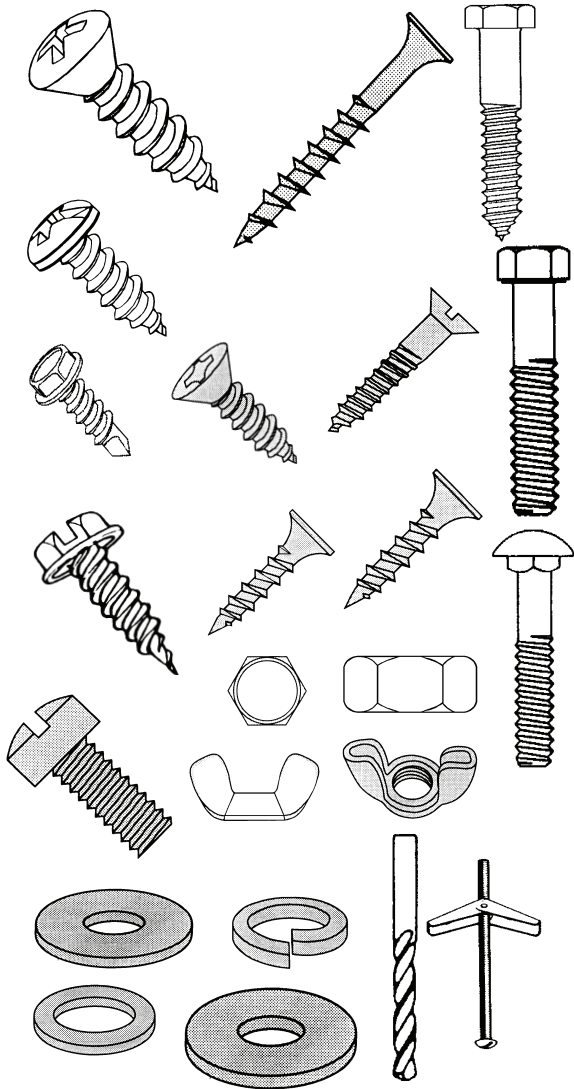

- Jiffy Point Screws
- Driltip Screws
- Painted Speed Screws
- Painted Register Screws
- Sheet Metal Screws
- Framing Screws
- Drywall Screws
- Deck Screws
- Wood Screws
- Concrete Screws
- Machine Screws
- Hex Cap Screws
- Carriage Bolts
- Lag Screws
- Hex Nuts
- Wing Nuts
- Coupling Nuts
- Flat Washers
- Lock Washers
- Fender Washers
- Rivets
- Drill Bits
- Drill Bit Indexes
- Masonry Bits
- Spade Wood Bits
- Anchors
- Anchor Kits
- Wedge Anchors
- Sleeve Anchors
- Drop-In Anchors
- Stove Bolts
- Threaded Rod
- Fastener Assort.
- Rod Hanger Fasteners

## Product Packaging Key

**POS** - Individually packaged for POS (boxed, bagged or carded) for hanging display

**CB** - Counter Bowl (Plastic)

**D** - Multiple Display Card

**HP** - Hang Pack - (Clear Plastic Hang Box or Bag)

**PL** - Plastic Box or Plastic Tub

**PB** - Plastic Bucket with Handle & Lid

**C** - Chipboard Box

**B** - Bulk Packaged - (Loose - Bagged - Boxed)

**JP** - Jiffy Pail

All Bulk Packaging includes quantity, product description and barcode number

Custom Packaging and Labeling Available

# “Jiffy Point” Screws

Full 1/4” (No. 8 & No. 10) Indented  
Slotted Hex Washer Head.

Zinc Plated

*Unique Hard Point ...  
Tapered, Sharp & Heat Treated  
for Maximum Penetration!*

Undercut Washer Seats  
Flush and Holds Tight

*DEEP Threads...  
Cut and Hold Tight!*

ALSO AVAILABLE WITH A  
BONDED SEALING WASHER

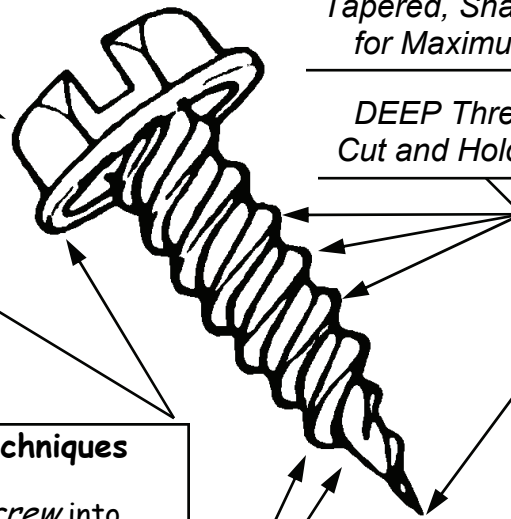

**Driving Tips and Techniques**

- Place “Jiffy Point” Screw into The *Original Magnetic Jiffy Chuck*.
- Press point of screw firmly against material to be drilled and fastened.
- Depress electric drill trigger to begin drilling.
- Once the screw threads engage the material, feather the drill trigger to tighten the “Jiffy Point” Screw.
- Driving technique may vary for lower speed, cordless drills or drills and screw guns with adjustable torque or automatic clutch features.

**Combination Twin Thread ...**  
*Single starting thread machined to the hard point of the screw.*  
*Second thread above the point for faster penetration*

The “Jiffy Point” screw. The perfect screw for easy 1-step fastening of a wide range of materials.  
 Layered light gauge galvanized sheet metal  
 Heavy gauge sheet metal  
 Laminates  
 Composition board  
 Plastics  
 Plywood  
 Hardwoods  
 Construction lumber

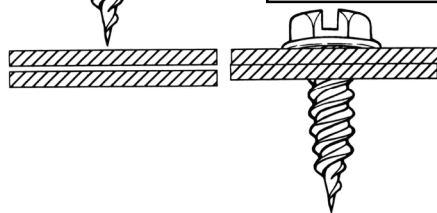
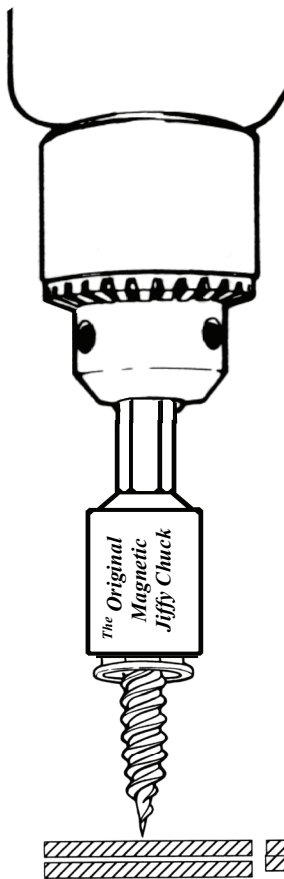

\*\*Note: Each production run is tested for drill time.

Test results available on request

“Jiffy Point” Screws offer excellent performance using an electric drill, screw gun, or driver.



Be sure to read about Shook's  
Quality Control Testing Procedures  
in the Appendix

# "Jiffy Point" Screws

## 1/4" Indented Hex Washer Head - Slotted, Hardened, Undercut Zinc Plated Sheet Metal Screws

Bar Code Number	Item Description	Size	Package Quantity
10601	Jiffy Point Xtra Sharp Screw - #6 x 3/8"		25 HP
10602	Jiffy Point Xtra Sharp Screw - #6 x 3/8"		100 Box
10604	Jiffy Point Xtra Sharp Screw - #6 x 3/8"		100 HP
10606	Jiffy Point Xtra Sharp Screw - #6 x 3/8"		500 PI Box
<b>10608</b>	Jiffy Point Xtra Sharp Screw - #6 x 3/8"		1000 PI Box
10600	Jiffy Point Xtra Sharp Screw - #6 x 3/8"		20 M Bulk
10603	Jiffy Point Xtra Sharp Screw - #6 x 3/8"		20 M Jiffy Pail
11001	Jiffy Point Xtra Sharp Screw - #7x1/2" - 821-R		25 HP
<b>11002</b>	Jiffy Point Xtra Sharp Screw - #7x1/2" - 821-1		100 Box
11003	Jiffy Point Xtra Sharp Screw - #7x1/2" - 821-1P		100 HP
11004	Jiffy Point Xtra Sharp Screw - #7x1/2" - 821-5		500 PI Box
<b>11006</b>	Jiffy Point Xtra Sharp Screw - #7x1/2" - 821-E		1000 PI Box
30900	Jiffy Point Xtra Sharp Screw - #7x1/2"		1000 PI Jar
11007	Jiffy Point Xtra Sharp Screw - #7x1/2" Includes 1 Jiffy Chuck		1000 PI Box
11008	Jiffy Point Xtra Sharp Screw - #7x1/2" - 821-B		5M PI Bucket
30761	Jiffy Point Xtra Sharp Screw - #7x1/2" -		7500 PI Bkt
11000	Jiffy Point Xtra Sharp Screw - #7x1/2" - 821		15M Bulk
11009	Jiffy Point Xtra Sharp Screw - #7x1/2"		15M Jiffy Pail
11011	Jiffy Point Xtra Sharp Screw - #8x1/2" - 822-R		25 HP
<b>11012</b>	Jiffy Point Xtra Sharp Screw - #8x1/2" - 822-1		100 Box
11013	Jiffy Point Xtra Sharp Screw - #8x1/2" - 822-1P		100 HP
11014	Jiffy Point Xtra Sharp Screw - #8x1/2" - 822-5		500 PI Box
<b>11016</b>	Jiffy Point Xtra Sharp Screw - #8x1/2" - 822-E		1000 PI Box
30904	Jiffy Point Xtra Sharp Screw - #8x1/2"		1000 PI Jar
11017	Jiffy Point Xtra Sharp Screw - #8x1/2" Includes 1 Jiffy Chuck		1000 PI Box
11018	Jiffy Point Xtra Sharp Screw - #8x1/2" - 822-B		5M PI Bucket
30762	Jiffy Point Xtra Sharp Screw - #8x1/2"		7M PI Bucket
11010	Jiffy Point Xtra Sharp Screw - #8x1/2" - 822		15M Bulk
11019	Jiffy Point Xtra Sharp Screw - #8x1/2"		15M Jiffy Pail

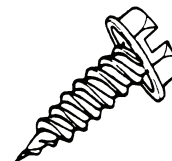
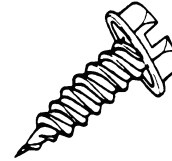



**"Jiffy Point" Screws** For the Professional Screw User

Indented Hex Washer Head - Slotted, Hardened, Undercut Zinc Plated Sheet Metal Screws  
1/4" HEX HEAD



Bar Code Number	Item Description	Size	Package Quantity
11021	Jiffy Point Screw - #8x3/4" -	823-R	25 HP
11022	Jiffy Point Screw - #8x3/4" -	823-1	100 Box
11023	Jiffy Point Screw - #8x3/4" -	823-1P	100 HP
11024	Jiffy Point Screw - #8x3/4" -	823-5	500 PI Box
11026	Jiffy Point Screw - #8x3/4" -	823-E	1000 PI Box
30908	Jiffy Point Screw - #8x3/4" -		1000 PI Jar
11027	Jiffy Point Screw - #8x3/4" -	Includes Jiffy Chuck	1000 PI Box
11028	Jiffy Point Screw - #8x3/4" -	823-B	3M PI Bucket
30763	Jiffy Point Screw - #8x3/4"		5M PI Bucket
11020	Jiffy Point - #8x3/4" -	823	10M Bulk
11029	Jiffy Point Screw - #8x3/4" -		10M Jiffy Pail
11031	Jiffy Point Screw - #8x1" -	824-R	25 HP
<b>11032</b>	Jiffy Point Screw - #8x1" -	824-1	100 Box
11033	Jiffy Point Screw - #8x1" -	824-1P	100 HP
<b>11034</b>	Jiffy Point Screw - #8x1" -	824-5	500 PI Box
30912	Jiffy Point Screw - #8x1" -		500 PI Jar
11035	Jiffy Point Screw - #8x1" -	824-J5 Includes Jiffy Chuck	500 PI Box
11036	Jiffy Point Screw - #8x1" -	824-E	1000 PI Jar
30915	Jiffy Point Screw - #8x1" -	Includes 1 Jiffy Chuck	1000 PI Jar
30764	Jiffy Point Screw - #8x1"		3.5M PI Bkt
<b>11030</b>	Jiffy Point Screw - #8x1" -	824	8M Bulk
11037	Jiffy Point Screw - #8x1"		8M Jiffy Pail
11039	Jiffy Point Screw - #8x1-1/4" -	825-R	25 HP
11040	Jiffy Point Screw - #8x1-1/4" -	825-1	100 Box
11042	Jiffy Point Screw - #8x1-1/4" -	825-5	500 PI Box
11041	Jiffy Point Screw - #8x1-1/4" -	825-J5 w/ Jiffy Chuck	500 PI Box
11044	Jiffy Point Screw - #8x1-1/4" -	825-E	1000 PI Jar
11038	Jiffy Point Screw - #8x1-1/4" -	825	5M Bulk
11043	Jiffy Point Screw - #8x1-1/4"		5M Jiffy Pail
11047	Jiffy Point Screw - #8x1-1/2" -	826-R	25 HP
11049	Jiffy Point Screw - #8x1-1/2" -	826-1P	50 HP
<b>11048</b>	Jiffy Point Screw - #8x1-1/2" -	826-1	100 Box
<b>11050</b>	Jiffy Point Screw - #8x1-1/2" -	826-250	250 PI Box
11051	Jiffy Point Screw - #8x1-1/2" -	Includes 1 Jiffy Chuck	250 PI Box
30916	Jiffy Point Screw - #8x1-1/2"		250 PI Jar
11052	Jiffy Point Screw - #8x1-1/2" -	826-5	500 PI Box
11054	Jiffy Point Screw - #8x1-1/2" -	826-E	1000 PI Jar
30765	Jiffy Point Screw - #8x1-1/2"		2250 PI Bkt
<b>11046</b>	Jiffy Point Screw - #8x1-1/2" -	826	5M Bulk
11055	Jiffy Point Screw - #8x1-1/2"		5M Jiffy Pail

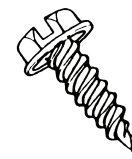
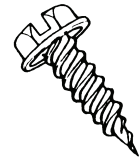

Note: bold bar coded items compare to other manufacturer's stock items

# Jiffy Point'Screws.... Continued

## 1/4" HEX HEAD *For the Professional Screw User*

Bar Code Number	Item Description	Size	Package Qty.
11057	Jiffy Point Screw - #8x2" - 827-R		25 HP
<b>11059</b>	Jiffy Point Screw - #8x2" - 827-1P		50 HP
11058	Jiffy Point Screw - #8x2" - 827-1		100 Box
<b>11060</b>	Jiffy Point Screw - #8x2" - 827-250		250 PI Box
30920	Jiffy Point Screw - #8x2" -		250 PI Jar
11061	Jiffy Point Screw - #8x2" Includes 1 Jiffy Chuck		250 PI Box
11062	Jiffy Point Screw - #8x2" - 827-5		500 PI Jar
<b>11064</b>	Jiffy Point Screw - #8x2" - 827-E		1000 Bucket
30766	Jiffy Point Screw - #8x2"		1400 PI Bkt
<b>11056</b>	Jiffy Point Screw - #8x2" - 827		3M Bulk
11053	Jiffy Point Screw - #8x2" -		3M Jiffy Pail
11070	Jiffy Point Screw - #10x1/2"- 828-1		100 Box
11071	Jiffy Point Screw - #10x1/2" - 828-1P		100 HP
11072	Jiffy Point Screw - #10x1/2" - 828-5		500 PI Box
11074	Jiffy Point Screw - #10x1/2" - 828-E		1000 PI Box
30924	Jiffy Point Screw - #10x1/2"		1000 PI Jar
11068	Jiffy Point Screw - #10x1/2" - 828		10M Bulk
30612	Jiffy Point Screw - #10x1/2"		10M Jiffy Pail
11077	Jiffy Point Screw - #10x3/4" - 829-R		25 HP
11078	Jiffy Point Screw - #10x3/4" - 829-1		100 Box
11079	Jiffy Point Screw - #10x3/4" - 829-1P		100 HP
11080	Jiffy Point Screw - #10x3/4" - 829-5		500 PI Box
30927	Jiffy Point Screw - #10x3/4"		500 PI Jar
11082	Jiffy Point Screw - #10x3/4" - 829-E		1000 PI Box
30928	Jiffy Point Screw - #10x3/4"		1000 PI Jar
11083	Jiffy Point Screw - #10x3/4" Includes 1 Jiffy Chuck		1000 PI Box
11076	Jiffy Point Screw - #10x3/4" - 829		8M Bulk
30614	Jiffy Point Screw - #10x3/4"		8M Jiffy Pail

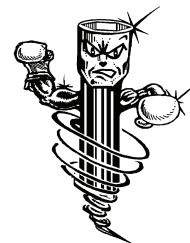
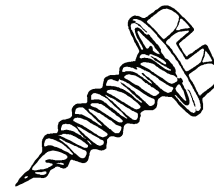
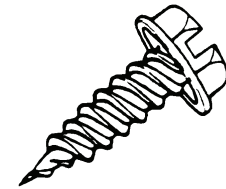

**Note:** Bold Bar Coded Items compare to other manufacturers' stock items

# Jiffy Point'Screws... For the Professional Screw User

Indented Hex Washer Head - Slotted, Hardened, Undercut Zinc Plated Sheet Metal Screws

## 1/4" HEX HEAD

NOTE:  
Items marked "w/  
chuck" include a  
1/4" x 1-3/4" Jiffy  
Chuck in the pack-  
age.

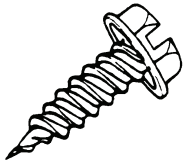

Bar Code Number	Item Description	Size	Package Quantity
11085	Jiffy Point Screw - #10x1" - 830-R		25 HP
11087	Jiffy Point Screw - #10x1" - 830-1P		50HP
<b>11086</b>	Jiffy Point Screw - #10x1" - 830-1		100 Box
<b>11088</b>	Jiffy Point Screw - #10x1" - 830-5		500 PI Box
30932	Jiffy Point Screw - #10x1"		500 PI Jar
11089	Jiffy Point Screw - #10x1" Includes Jiffy Chuck - 830-J5		500 PI Box
11090	Jiffy Point Screw - #10x1" - 830-E		1000 PI Jar
11091	Jiffy Point Screw - #10x1"		3000 PI Bucket
<b>11084</b>	Jiffy Point Screw - #10x1" - 830		5M Bulk
30616	Jiffy Point Screw - #10x1"		5M Jiffy Pail
11093	Jiffy Point Screw - #10x1-1/4" - 831-R		25 HP
11094	Jiffy Point Screw - #10x1-1/4" - 831-1		100 Box
11096	Jiffy Point Screw - #10x1-1/4" - 831-5		500 PI Box
11098	Jiffy Point Screw - #10x1-1/4" - 831-E		1000 PI Jar
11092	Jiffy Point Screw - #10x1-1/4" - 831		4M Bulk
10751	Jiffy Point Screw - #10x1-1/2" 832-R		25 HP
10752	Jiffy Point Screw - #10x1-1/2" 832-1		100 Box
10754	Jiffy Point Screw - #10x1-1/2" 132-5		500 PI Box
10758	Jiffy Point Screw - #10x1-1/2" Includes Jiffy Chuck 832-J5		500 PI Box
10756	Jiffy Point Screw - #10x1-1/2"		1000 PI Jar
10750	Jiffy Point Screw - #10x1-1/2" 832		5M Bulk
30618	Jiffy Point Screw - #10x1-1/2"		5M Jiffy Pail
10761	Jiffy Point Screw - #10x2" 133-R		25 HP
10762	Jiffy Point Screw - #10x2" 833-1		100 Box
10763	Jiffy Point Screw - #10x2" 833-250		250 PI Box
10764	Jiffy Point Screw - #10x2" 833-5		500 PI Jar
10768	Jiffy Point Screw - #10x2" 833-J5 Includes Jiffy Chuck		500 PI Jar
10760	Jiffy Point Screw - #10x2" 833		2M Bulk
30620	Jiffy Point Screw - #10x2"		2M Jiffy Pail

## 1/4" HEX HEAD w/ 5/16" WASHER

30645	Jiffy Point Screw - #10x2-1/2"		100 Box
30647	Jiffy Point Screw - #10x3"		100 Box
30649	Jiffy Point Screw - #10x4"		100 Box
30651	Jiffy Point Screw - #10x5"		100 Box

## 5/16" HEX HEAD

## "Jiffy Point" Screws For the Professional Screw User

Indented Hex Combo Washer Head - Hardened, Undercut Zinc Plated Sheet Metal Screws

Bar Code Number	Item Description	Size	Package Quantity
10775	Jiffy Point Screw- #10x1/2"	828-SR	25 HP
10776	Jiffy Point Screw- #10x1/2"	828-S1	100 Box
10778	Jiffy Point Screw- #10x1/2"	828-S5	500 PI Box
10779	Jiffy Point Screw- #10x1/2"		500 PI Jar
10780	Jiffy Point Screw- #10x1/2"	828-SE	1000 PI Box
<b>10774</b>	Jiffy Point Screw- #10x1/2"	828-S	10M Bulk
30622	Jiffy Point Screw- #10x1/2"		10M Jiff Pail
10783	Jiffy Point Screw- #10x3/4"		25 HP
10784	Jiffy Point Screw- #10x3/4"	829-S1	100 Box
10786	Jiffy Point Screw- #10x3/4"	838-S5	500 PI Box
10785	Jiffy Point Screw- #10x3/4"		500 PI Jar
10788	Jiffy Point Screw- #10x3/4"	828-SE	1000 PI Jar
10782	Jiffy Point Screw- #10x3/4"	829-S	8M Bulk
30624	Jiffy Point Screw- #10x3/4"		8M Jiffy Pail
10791	Jiffy Point Screw- #10x1"		25 HP
10792	Jiffy Point Screw- #10x1"	830-S	100 Box
10794	Jiffy Point Screw- #10x1"	830-S5	500 PI Box
10795	Jiffy Point Screw- #10x1"		500 PI Jar
10790	Jiffy Point Screw- #10x1"	830-S	6M Bulk
30626	Jiffy Point Screw- #10x1"		6M Jiffy Pail
30500	Jiffy Point Screw- #10x1-1/4"		100 Box
30502	Jiffy Point Screw- #10x1-1/4"		500 PI Box
30657	Jiffy Point Screw- #10x1-1/4"		5M Bulk
30641	Jiffy Point Screw- #10x1-1/4"		5M Jiffy Pail
10797	Jiffy Point Screw- #10x1-1/2"		25 HP
10798	Jiffy Point Screw- #10x1-1/2"	832-S1	100 Box
10800	Jiffy Point Screw- #10x1-1/2"	832-S250	250 PI Box
10802	Jiffy Point Screw- #10x1-1/2"	828-SE	1000 PI Jar
10796	Jiffy Point Screw- #10x1-1/2"	832-S	4M Bulk
30628	Jiffy Point Screw- #10x1-1/2"		4M Jiffy Pail
10805	Jiffy Point Screw- #10x2"		25 HP
10806	Jiffy Point Screw- #10x2"	833-S1	100 Box
10807	Jiffy Point Screw- #10x2"		250 PI Box
30643	Jiffy Point Screw- #10x2"		500 PI Jar
10804	Jiffy Point Screw- #10x2"	833-S	1M Bulk
30630	Jiffy Point Screw- #10x2"		1M Jiffy Pail

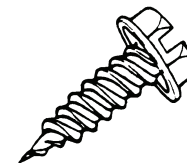
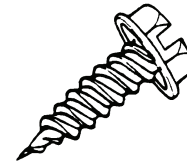

Note: Bold Bar Coded Items compare to other manufacturer's stock items.

# Jiffy Pails *Jiffy Point'Screws...* Continued

Indented Hex Washer Head - Slotted, Hardened, Undercut Zinc Plated Sheet Metal Screws

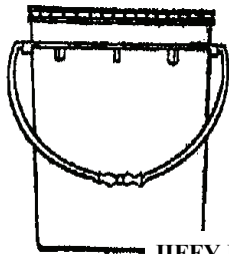

JIFFY PAIL

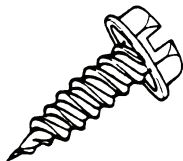

BAR CODE	SIZE	DESCRIPTION	PKG. QTY.
10603	6x3/8	1/4" Hex Head	20M Jiffy Pail
11009	7x1/2	1/4" Hex Head	15M Jiffy Pail
11019	8x1/2	1/4" Hex Head	15M Jiffy Pail
11029	8x3/4	1/4" Hex Head	10M Jiffy Pail
11037	8x1	1/4" Hex Head	8M Jiffy Pail
11043	8x1 1/4	1/4" Hex Head	5M Jiffy Pail
11055	8x1 1/2	1/4" Hex Head	5M Jiffy Pail
11053	8x2	1/4" Hex Head	3M Jiffy Pail
30612	10x1/2	1/4" Hex Head	10M Jiffy Pail
30614	10x3/4	1/4" Hex Head	8M Jiffy Pail
30616	10x1	1/4" Hex Head	5M Jiffy Pail
30618	10x1-1/2	1/4" Hex Head	5M Jiffy Pail
30620	10x2	1/4" Hex Head	2M Jiffy Pail
30622	10x1/2	5/16" Hex Head	10M Jiffy Pail
30624	10x3/4	5/16" Hex Head	8M Jiffy Pail
30626	10x1	5/16" Hex Head	6M Jiffy Pail
30641	10x1-1/4	5/16" Hex Head	5M Jiffy Pail
30628	10x1-1/2	5/16" Hex Head	4M Jiffy Pail
30630	10x2	5/16" Hex Head	1M Jiffy Pail

## High Hat Jiffy Point

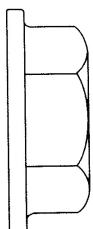

STANDARD HEAD

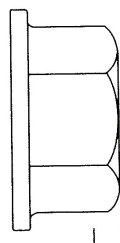

HIGH HAT HEAD



FEATURES 25-35%  
HIGHER HEAD  
HEIGHT THAN  
STANDARD HEAD  
FOR MORE SECURE  
DRIVING

10709	10x1/2	High Hat w 5/16 Washer	100 Box
10711	10x1/2	High Hat w 5/16 Washer	500 PI Box
10713	10x1/2	High Hat w 5/16 Washer	5M Jiffy Pail
10715	10x1/2	High Hat w 5/16 Washer	10M Bulk
10735	10x3/4	High Hat w 5/16 Washer	25 HP
10737	10x3/4	High Hat w 5/16 Washer	100 Box
10739	10x3/4	High Hat w 5/16 Washer	100 HP
10755	10x3/4	High Hat w 5/16 Washer	500 PI Box
10759	10x3/4	High Hat w 5/16 Washer	1000 PI Box
10767	10x3/4	High Hat w 5/16 Washer	1000 PI Box w Chuck
10731	10x3/4	High Hat w 5/16 Washer	9M Jiffy Pail
10733	10x3/4	High Hat w 5/16 Washer	9M Bulk
10701	10x1	High Hat w 5/16 Washer	6M Bulk
30687	10x1-1/2	High Hat w 5/16 Washer	100 Box
30681	10x1-1/2	High Hat w 5/16 Washer	500 PI Box
10717	10x2	High Hat w 5/16 Washer	100 Box
10719	10x2	High Hat w 5/16 Washer	500 PI Jar
10707	10x2	High Hat w 5/16 Washer	2M Bulk

**BULK CARTONS**

**"Jiffy Point" Screws.... Continued**  
**For the Professional Screw**

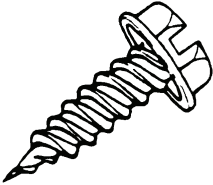
Indented Hex Washer Head - Slotted, Hardened, Undercut Zinc Plated Sheet Metal Screws

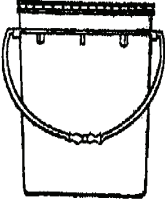
	BAR CODE	SIZE	DESCRIPTION	STK. #	PKG. QTY.
     <p>Buckets</p>	<b>10600</b>	6x3/8	1/4" Hex Head		20M Bulk
	<b>11000</b>	7x1/2	1/4" Hex Head	821	15M Bulk
	<b>11010</b>	8x1/2	1/4" Hex Head	822	15M Bulk
	<b>11020</b>	8x3/4	1/4" Hex Head	823	10M Bulk
	<b>11030</b>	8x1	1/4" Hex Head	824	8M Bulk
	11038	8x1 1/4	1/4" Hex Head	825	5M Bulk
	<b>11046</b>	8x1 1/2	1/4" Hex Head	826	5M Bulk
	<b>11056</b>	8x2	1/4" Hex Head	827	3M Bulk
	<b>11068</b>	10x1/2	1/4" Hex Head	828	10M Bulk
	<b>11076</b>	10x3/4	1/4" Hex Head	829	8M Bulk
	<b>11084</b>	10x1	1/4" Hex Head	830	7M Bulk
	11092	10x1 1/4	1/4" Hex Head	831	4M Bulk
	10750	10x1 1/2	1/4" Hex Head	832	5M Bulk
	10760	10x2	1/4" Hex Head	833	2M Bulk
	10774	10x1/2	5/16" Hex Head	828-S	10M Bulk
	10782	10x3/4	5/16" Hex Head	829-S	8M Bulk
	10790	10x1	5/16" Hex Head	830-S	6M Bulk
	30657	10x1 1/4	5/16" Hex Head		5M Bulk
	10796	10x1 1/2	5/16" Hex Head	832-S	4M Bulk
	10804	10x2	5/16" Hex Head	833-S	1M Bulk
	<b>11008</b>	7x1/2	1/4" Hex Head	821-B	5M Bucket
	<b>11018</b>	8x1/2	1/4" Hex Head	822-B	5M Bucket
	<b>11028</b>	8x3/4	1/4" Hex Head	823-B	3M Bucket
	11015	8x1/2	1/4" Hex Head		Sample Pack

**Note:** Bold Bar Coded Items compare to other manufacturers' stock items.

# SUPER "Jiffy" Point

Zinc Plated

Full 1/4" (No. 8) Indented Slotted Hex Washer Head.

Unique Hard Point ...  
Tapered, Sharp & Heat Treated  
for Maximum Penetration!

Undercut Washer Seats  
Flush and Holds Tight

DEEP Threads...  
Cut and Hold Tight!

EXTRA LONG POINT

## 12% longer than the standard 7x1/2 & 8x1/2

Available in SUPER 7 and SUPER 8

Combination Twin  
Thread ...

Single starting thread  
machined to the **hard  
point** of the screw.

Second thread above  
the point for **faster  
penetration**

**SUPER 8 "Jiffy" Point Screws**  
8x1/2  
12% longer than standard 8 x 1/2  
1000 Pcs.  
Slotted Hex Washer Head  
Zinc Plated

**SHOOK**  
AKRON, OHIO U.S.A.

This product contains a mixture of domestic articles and articles from one or more foreign countries, including the following: Japan, Taiwan, Korea, China.

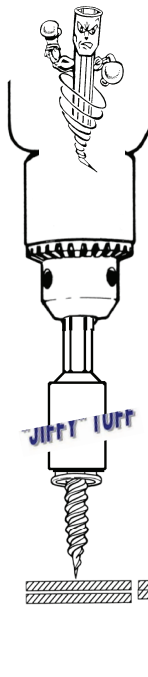

### Driving Tips and Techniques

- Place "Jiffy" Point Screw into The **Original Magnetic "Jiffy" Chuck**.
- Press point of screw firmly against material to be drilled and fastened.
- Depress electric drill trigger to begin drilling.
- Once the screw threads engage the material, feather the drill trigger to tighten the "Jiffy" Point Screw.
- Driving technique may vary for lower speed, cordless drills or drills and screw guns with adjustable torque or automatic clutch features.

Test results available on request

"Jiffy" Point Screws offer excellent performance using an electric drill, screw gun, or driver.

BAR CODE	SIZE	DESCRIPTION	PKG. QTY.
30804	7x1/2	Super 7 Jiffy Point	100 Box
30814	8x1/2	Super 8 Jiffy Point	100 Box
30802	7x1/2	Super 7 Jiffy Point	1000 PI Box
30812	8x1/2	Super 8 Jiffy Point	1000 PI Box
30803	7x1/2	Super 7 Jiffy Point	500 PI Box
30813	8x1/2	Super 8 Jiffy Point	500 PI Box
30800	7x1/2	Super 7 Jiffy Point	15M Jiffy Pail
30810	8x1/2	Super 8 Jiffy Point	15M Jiffy Pail
30806	7x1/2	Super 7 Jiffy Point	5M Bucket
30816	8x1/2	Super 8 Jiffy Point	5M Bucket

***Jiffy Point'Screws... Cont***  
***For the Professional Screw User***

**Indented Hex Washer Head - Slotted, Hardened, Undercut Zinc Plated Sheet Metal Screws**

**PAINTED REGISTER SCREWS**

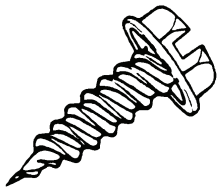

BAR CODE	SIZE	DESCRIPTION	STK. #	PKG. QTY.
10960	8x1 1/2	Hex White Head		50 HP
10958	8x1 1/2	Hex White Head	826-W1	100 Box
10962	8x1 1/2	Hex White Head		250 PI Box
10918	8x1 1/2	Hex White Head		500 PL Box
30632	8x1 1/2	Hex White Head		5M Jiffy Pail
10956	8x1 1/2	Hex White Head	826-W	5M Bulk
10976	8x2	Hex White Head		50 HP
10974	8x2	Hex White Head		100 Box
11063	8x2	Hex White Head		250 PL Box
10926	8x2	Hex White Head		500 PL Box
10920	8x2	Hex White Head		1M Box
10972	8x2	Hex White Head		3M Bulk
30638	8x2	Hex White Head		3M Jiffy Pail
10933	8x2	Phil Oval White Head		50 PL Hang PK
10928	8x2	Phil Oval White Head	850-1	100 Box
10930	8x2	Phil Oval White Head	850-250	250 PL Box
10932	8x2-1/2	Phil Flat White Head		100 Box
10934	8x2 1/2	Phil Flat White Head		250 PI Box
10988	8x2	Phillips Pan Head		100 Box
10990	8x2	Phillips Pan Head		250 PI Box
10954	8x3	Hex White Head		100 Box
10955	8x3	Hex White Head		250 Box
30646	8x3	Hex White Head		2M Jiffy Pail



# Drilтип Screws

Available with Hex Head  
or Pan Head

Undercut Washer Seats  
Flush and Holds Tight

ALSO AVAILABLE WITH A  
BONDED SEALING WASHER

High Speed Drilтип Bit Tip...  
Drills - Taps - Threads - Inserts  
All in 1 EZ Step!

DEEP Threads...  
Cut and Hold Tight!

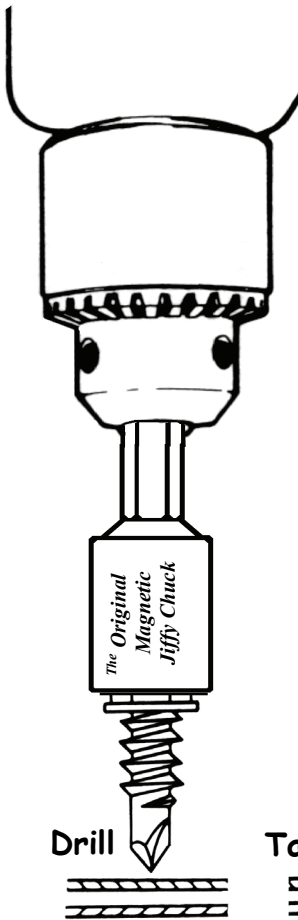
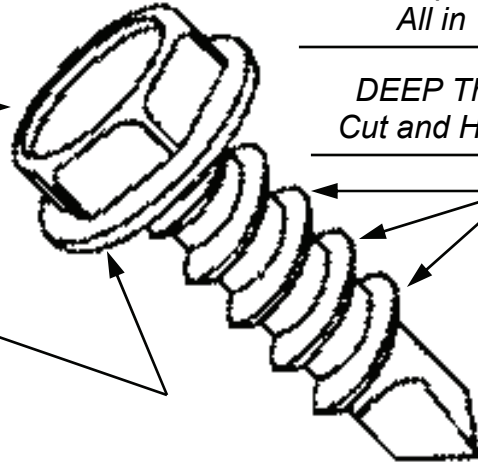

### Tips and Techniques

Place *Jiffy Drilтип Screw* into  
The *Original Magnetic Jiffy  
Chuck*.

Press firmly against material to  
be drilled, tapped and fastened.

Depress electric drill trigger to  
begin drilling.  
Once hole is drilled, feather the  
drill trigger to tighten the *Jiffy  
Drilтип Screw*.

Screw Size	Threads Per Inch	Drill Point Size
# 8	18	#2
#10	16	#3
#12	14	#3
#14	14	#3

The *Drilтип* Screw. The perfect screw for easy 1-step fastening of a wide range of materials...

- Sheet metal
- Structural steel
- Laminates
- Composition board
- Plastics
- Plywood
- Hardwoods
- Construction lumber

For optimal performance, an electric drill, screw gun, or driver rated at 2500 R.P.M. is recommended when fastening various materials with *Jiffy Drilтип* Screws.

**1/4" Hex Head # 2 Point**

**"Jiffy Drilltip" Screws**

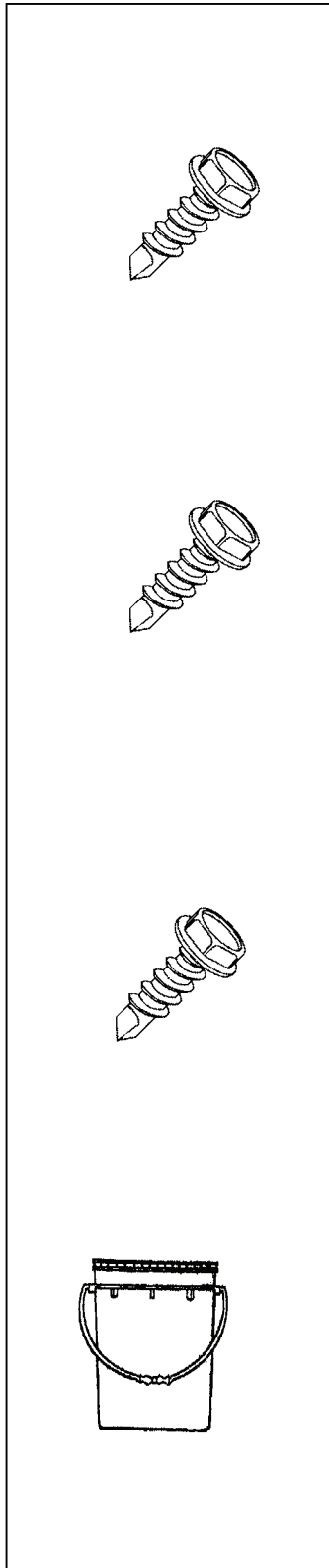

Bar Code Number	Item Description	Size	Package Quantity
11201	Jiffy Drilltip Screw - #8 x 1/2 -	175-R	25 HP
11202	Jiffy Drilltip Screw - #8 x 1/2 -	175-1	100 Box
11203	Jiffy Drilltip Screw - #8 x 1/2		100 HP
11204	Jiffy Drilltip Screw - #8 x 1/2 -	175-5	500 PL Box
30842	Jiffy Drilltip Screw - #8 x 1/2		500 PI Jar
11206	Jiffy Drilltip Screw - #8 x 1/2 -	175-E	1000 PL Box
30850	Jiffy Drilltip Screw - #8 x 1/2		1000 PI Jar
11210	Jiffy Drilltip Screw - #8 x 1/2 Includes Jiffy Chuck		1000 PL Box
11208	Jiffy Drilltip Screw - #8 x 1/2 -	175-B	5000 Bucket
11200	Jiffy Drilltip Screw - #8 x 1/2 -	175	10M Bulk
30650	Jiffy Drilltip Screw - #8 x 1/2		10M Jiffy Pail
11214	Jiffy Drilltip Screw - #8 x 5/8 -	176-1	100 Box
11216	Jiffy Drilltip Screw - #8 x 5/8 -	176-5	500 PL Box
11218	Jiffy Drilltip Screw - #8 x 5/8 -	176-E	1000 PL Box
11221	Jiffy Drilltip Screw - #8 x 3/4 -	177-R	25 HP
11222	Jiffy Drilltip Screw - #8 x 3/4 -	177-1	100 Box
11223	Jiffy Drilltip Screw - #8 x 3/4		100 HP
11224	Jiffy Drilltip Screw - #8 x 3/4 -	177-5	500 PL Box
30846	Jiffy Drilltip Screw - #8 x 3/4		500 PL Screw Top Jar
11226	Jiffy Drilltip Screw - #8 x 3/4 -	177-E	1000 PL Box
30854	Jiffy Drilltip Screw - #8 x 3/4		1000 PI Jar
11228	Jiffy Drilltip Screw - #8 x 3/4 -	177-B	3000 Bucket
11220	Jiffy Drilltip Screw - #8 x 3/4 -	177	10M Bulk
30652	Jiffy Drilltip Screw - #8 x 3/4		10M Jiffy Pail

11233	Jiffy Drilltip Screw - #8 x 1 -	178-R	25 HP
11234	Jiffy Drilltip Screw - #8 x 1 -	178-1	100 Box
11235	Jiffy Drilltip Screw - #8 x 1		100 HP
30857	Jiffy Drilltip Screw - #8 x 1		250 PI Jar
11236	Jiffy Drilltip Screw - #8 x 1 -	178-5	500 PL Box
11238	Jiffy Drilltip Screw - #8 x 1 -	178-E	1000 PL Jar
11240	Jiffy Drilltip Screw - #8 x 1 -178-J Includes Jiffy Chuck		1000 PL Jar
11242	Jiffy Drilltip Screw - #8 x 1-1/4 -	189-1	100 Box
11246	Jiffy Drilltip Screw - #8 x 1-1/2 -	190-1	100 Box
11248	Jiffy Drilltip Screw - #8 x 1-1/2 -	190-250	250 PL Box
30663	Jiffy Drilltip Screw - #8 x 1-1/2		5M Bulk

**5/16" Hex Head #3 Point**

# "Jiffy Drilltip" Screws

Bar Code Number	Item Description	Size	Package Quantity
11250	Jiffy Drilltip Screw - #8 x 2 -	191-1	100 Box
11252	Jiffy Drilltip Screw - #8 x 2 -	191-250	250 PL Box
11258	Jiffy Drilltip Screw - #10 x 1/2 -	179-1	100 Box
11259	Jiffy Drilltip Screw - #10 x 1/2		100 HP
11260	Jiffy Drilltip Screw - #10 x 1/2 -	179-5	500 PL Box
11261	Jiffy Drilltip Screw - #10 x 1/2		500 PL Screw Top Jar
11262	Jiffy Drilltip Screw - #10 x 1/2 -	179-E	1000 PL Box
11256	Jiffy Drilltip Screw - #10 x 1/2 -	179	8M Bulk
30662	Jiffy Drilltip Screw - #10 x 1/2		8M Jiffy Pail
31308	Jiffy Drilltip Screw - #10 x 5/8		100 Box
31310	Jiffy Drilltip Screw - #10 x 5/8		100 PI Box
31312	Jiffy Drilltip Screw - #10 x 5/8		500 PI Box
31300	Jiffy Drilltip Screw - #10 x 5/8		8M Bulk
11266	Jiffy Drilltip Screw - #10 x 3/4 -	180-1	100 Box
11269	Jiffy Drilltip Screw - #10 x 3/4		100 HP
11268	Jiffy Drilltip Screw - #10 x 3/4 -	180-5	500 PI Box
11263	Jiffy Drilltip Screw - #10 x 3/4		500 PL Screw Top Jar
30866	Jiffy Drilltip Screw - #10 x 3/4 Includes 1 Jiffy Chuck		500 PI Box
11270	Jiffy Drilltip Screw - #10 x 3/4		1000 PI Box
30868	Jiffy Drilltip Screw - #10 x 3/4		1000 PI Jar
30870	Jiffy Drilltip Screw - #10 x 3/4 Includes 1 Jiffy Chuck		1000 PI Jar
11271	Jiffy Drilltip Screw - #10 x 3/4 -	180-B	2000 Bucket
11264	Jiffy Drilltip Screw - #10 x 3/4 -	180	7M Bulk
30664	Jiffy Drilltip Screw - #10 x 3/4		7M Jiffy Pail
30731	Jiffy High Hat Head Drilltip Screw - #10 x 3/4		100 Box
30733	Jiffy High Hat Head Drilltip Screw - #10 x 3/4		500 PL Box
30737	Jiffy High Hat Head Drilltip Screw - #10 x 3/4		500 PL Jar w/ Chuck
30739	Jiffy High Hat Head Drilltip Screw - #10 x 3/4		1000 Box
11285	Jiffy High Hat Head Drilltip Screw - #10 x 3/4		6M Bulk
11291	Jiffy High Hat Head Drilltip Screw - #10 x 3/4		6M Jiffy Pail
11274	Jiffy Drilltip Screw - #10 x 1 -	181-1	100 Box
11275	Jiffy Drilltip Screw - #10 x 1		100 HP
11276	Jiffy Drilltip Screw - #10 x 1 -	181-5	500 PI Box
11278	Jiffy Drilltip Screw - #10 x 1 -	181-E	1000 PI Box
11272	Jiffy Drilltip Screw - #10 x 1 -	181	5M Bulk
30666	Jiffy Drilltip Screw - #10 x 1		5M Jiffy Pail
30878	Jiffy Drilltip Screw - #10 x 1-1/4		100 Box
30668	Jiffy Drilltip Screw - #10 x 1-1/4		4M Jiffy Pail
11281	Jiffy Drilltip Screw - #10 x 1-1/2	183-R	25 HP
11282	Jiffy Drilltip Screw - #10 x 1-1/2 -	183-1	100 Box
11284	Jiffy Drilltip Screw - #10 x 1-1/2 -	183-250	250 PI Box
11280	Jiffy Drilltip Screw - #10 x 1-1/2 -	183	3M Bulk
30670	Jiffy Drilltip Screw - #10 x 1-1/2		3M Jiffy Pail

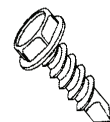

5/16" Hex Head #3 Point **"Jiffy" Driltip Screws ...Continued**

Bar Code Number	Item Description	Size	Package Quantity
11287	Jiffy Driltip Screw - #10 x 2 -	184-R	25 HP
11288	Jiffy Driltip Screw - #10 x 2 -	184-1	100 Box
30882	Jiffy Driltip Screw - #10 x 2		150 PL Jar
11290	Jiffy Driltip Screw - #10 x 2 -	184-250	250 PL Box
31202	Jiffy Driltip Screw - #10 x 2-1/2		100 Box
30884	Jiffy Driltip Screw - #10 x 2-1/2		1 M Jiffy Pail
31208	Jiffy Driltip Screw - #10 x 3		100 Box
31210	Jiffy Driltip Screw - #10 x 3		250 PL Box
31206	Jiffy Driltip Screw - #10 x 3		1M Bulk
30886	Jiffy Driltip Screw - #10 x 3		1M Jiffy Pail
11296	Jiffy Driltip Screw - #12 x 3/4 -	187-1	100 Box
11298	Jiffy Driltip Screw - #12 x 3/4 -	187-5	500 PL Box
30674	Jiffy Driltip Screw - #12 x 3/4		6M Jiffy Pail
11302	Jiffy Driltip Screw - #12 x 1 -	188-1	100 Box
11304	Jiffy Driltip Screw - #12 x 1 -	188-5	500 PL Box
11308	Jiffy Driltip Screw - #12 x 1-1/2 -	182-1	100 Box
11312	Jiffy Driltip Screw - #12 x 2 -	192-1	100 Box
31222	Jiffy Driltip Screw - #12 x 3		100 Box

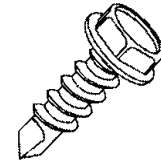
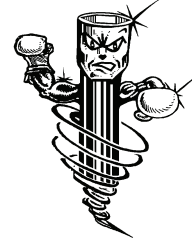

**3/8" Hex Head**

11320	Jiffy Driltip Screw - #14 x 3/4		100 Box
11326	Jiffy Driltip Screw - #14 x 1		100 Box
11328	Jiffy Driltip Screw - #14 x 1		250 PL Box
11330	Jiffy Driltip Screw - #14 x 1-1/2		100 Box
30887	Jiffy Driltip Screw - #14 x 2		100 Box

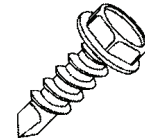

**Phillips Pan Head**

Bar Code Number	Item Description	Size	Package Quantity
11340	Jiffy Driltip Screw-PH - #8 x 1/2 -	875-1	100 Box
11364	Jiffy Driltip Screw-PH - #10 x 1/2 -	870-5	500 PL Box
11370	Jiffy Driltip Screw-PH - #10 x 3/4 -	871-5	500 PL Box



**Slotted Hex Washer Head**

30713	Jiffy Driltip Screw- #8 x 1/2		500 PL Jar w/ Screw Lid
30717	Jiffy Driltip Screw- #8 x 1/2		1000 PL Jar w/ Screw Lid



**“Jiffy” Driltip Screws ... Continued**  
**5/16” Hex Head with - Bonded Sealing Washers**

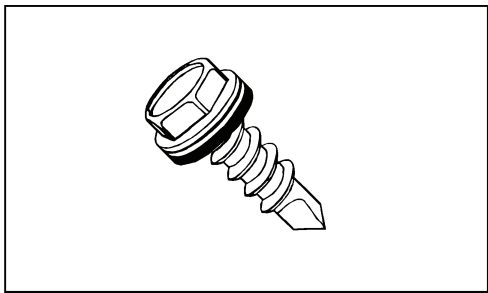

Bar Code Number	Item Description	Size	Package Quantity
11382	Jiffy Driltip Screw – SW	#10 x 3/4 - 880-1	100 Box
11388	Jiffy Driltip Screw – SW	#12 x 3/4 - 887-1	100 Box
11390	Jiffy Driltip Screw – SW	#12 x 3/4 - 887-5	500 PL Box
11396	Jiffy Driltip Screw – SW	#12 x 1 - 888-5	500 PL Box
11392	Jiffy Driltip Screw – SW	#12 x 1 - 888	2.5M Bulk
11402	Jiffy Driltip Screw - SW	#12 x 1-1/2 - 882-5	500 PL Box

**Bonded Sealing Washers**

EPDM rubber bonded to steel  
 For Jiffy Driltip Screws, Jiffy Point Screws, & all other sheet metal fasteners to make a weathertight Seal.

Call for price & availability on other sizes



Bar Code Number	Item Description	Size	Package Quantity
11484	Sealing Washer - #8-10	(8 x 1/2" dia.)	100 Bulk
11482	Sealing Washer - #8-10	(8 x 1/2" dia.)	1000 Bulk

**Jiffy Pails-Driltip Screws**

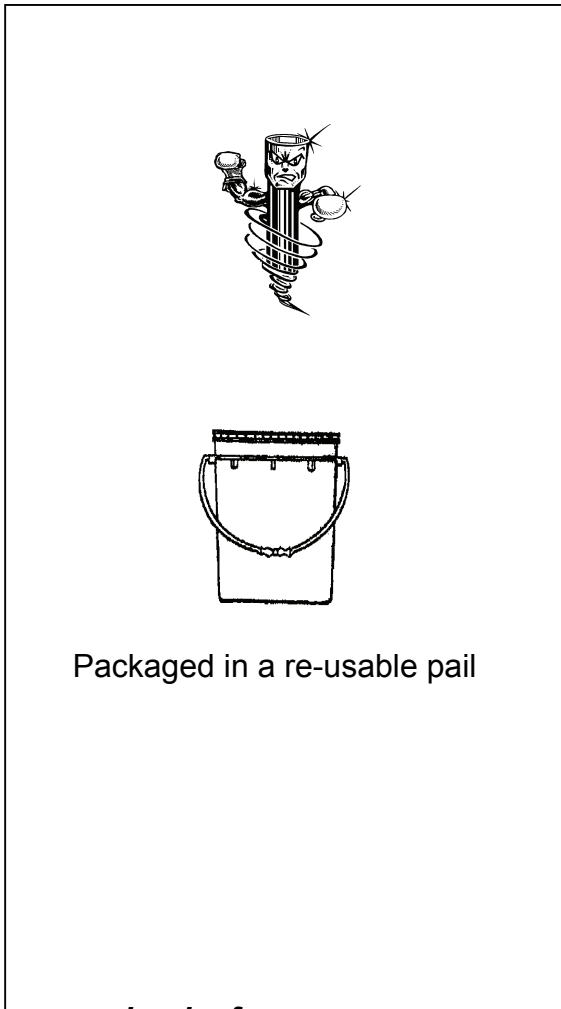

Packaged in a re-usable pail

Bar Code Number	Item Description	Size	Package Quantity
30650	1/4" Hex Driltip - #8	x 1/2	10M
30652	1/4" Hex Driltip - #8	x 3/4	10M
30654	1/4" Hex Driltip - #8	x 1	8M
30656	1/4" Hex Driltip - #8	x 1-1/4	5M
30658	1/4" Hex Driltip - #8	x 1-1/2	5M
30660	1/4" Hex Driltip - #8	x 2	3M
30662	5/16" Hex Driltip - #10	x 1/2	8M
30664	5/16" Hex Driltip - #10	x 3/4	7M
30666	5/16" Hex Driltip - #10	x 1	5M
30668	5/16" Hex Driltip - #10	x 1-1/4	4M
30670	5/16" Hex Driltip - #10	x 1-1/2	3.5M
30672	5/16" Hex Driltip - #10	x 2	1.5M
30674	5/16" Hex Driltip - #12	x 3/4	6M
30676	5/16" Hex Driltip - #12	x 1	4M
30678	5/16" Hex Driltip - #12	x 1-1/4	3M
30680	5/16" Hex Driltip - #12	x 1-1/2	3M
30682	5/16" Hex Driltip - #12	x 2	2M
30684	5/16" Hex Driltip - #12	x 2-1/2	1.5M
30686	5/16" Hex Driltip - #12	x 3	1M
30688	3/8" Hex Driltip - #14	x 3/4	4M
30690	3/8" Hex Driltip - #14	x 1	3M
30692	3/8" Hex Driltip - #14	x 1-1/2	2M
30694	3/8" Hex Driltip - #14	x 2	1.5M
30696	3/8" Hex Driltip - #14	x 2-1/2	1M
30698	3/8" Hex Driltip - #14	x 3	1M
40012	Plastic 3-1/2 Gal Pail w/ Screw Top	Lid	1

# "Jiffy" Screws

## 1/4" - SLOTTED HEX HEAD

*Indented slotted hex head  
Type A Tapping  
Hardened  
Zinc plated  
Perfect for use with bonded sealing washers*

Bar Code Number	Item Description	Size	Package Quantity
11104	Jiffy Screw - #8 x 1/4 - 147-E		1000 PI Box
11100	Jiffy Screw - #8 x 1/4 - 147		6.25M Box
11107	Jiffy Screw - #8 x 3 - 149-R		25 HP
11108	Jiffy Screw - #8 x 3 - 149-1		100 Box

### 5/16" - Slotted Hex Head

11114	Jiffy Screw - #12 x 1 - 134-1		100 Box
11120	Jiffy Screw - #12 x 1-1/4 - 135-1		100 Box
11126	Jiffy Screw - #12 x 1-1/2 - 136-1		100 Box
11132	Jiffy Screw - #12 x 2 - 137-1		100 Box
11134	Jiffy Screw - #12 x 2 - 137-5		500 Box

### 3/8" - Slotted Hex Head

11150	Jiffy Screw - #14 x 1-1/4 - 139-1		100 Box
11156	Jiffy Screw - #14 x 1-1/2 - 140-1		100 Box
11162	Jiffy Screw - #14 x 2 - 140-1		100 Box
11160	Jiffy Screw - #14 x 2 - 140		1.5M Bulk

## Stainless Steel Screws

**1/4" - Indented Hex Washer Head, Slotted Self- Piercing Sheet Metal Screw**

Bar Code Number	Item Description	Size	Package Quantity
11505	Stainless Steel Screw—# 6 x 3/8		100 box
11507	Stainless Steel Screw—# 6 x 3/8		1M PI Box
10911	7 x 1/2 Stainless Steel Speed Screw— White		100 Bag
11511	Stainless Steel Screw - #8 x 1/2 - 802-1		100 Box
11513	Stainless Steel Screw - #8 x 1/2 - 802-E		1M PI Box
11514	Stainless Steel Screw - #8 x 3/4 - 803-1		100 Box
11519	Stainless Steel Screw - #10 x 1-1/2		25 HP
11520	Stainless Steel Screw - #10 x 1-1/2- 804-1		100 Box

### Stainless Steel Driptip Screws— Unslotted

11523	Stainless Steel Driptip Screw - #8 x 1/2 - 805-1		100 Box
11529	Stainless Steel Driptip Screw - #8 x 3/4		100 Box
11525	Stainless Steel Driptip Screw - #10 x 3/4- 808-1		100 Box
11526	Stainless Steel Driptip Screw - #10 x 3/4- 808-5		500 PI Box
11530	Stainless Steel Driptip Screw - #14 x 1-1/4		100 Box

**E-mail: [shookmfg@earthlink.net](mailto:shookmfg@earthlink.net)**

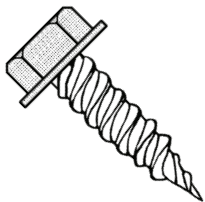
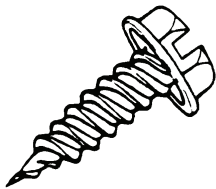

# Combo Phillips/Slotted Pan Head Screws

Type A – Tapping  
Hardened  
Zinc Plated

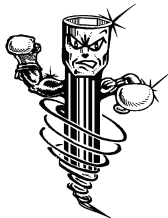

Bar Code Number	Item Description	Size	Pkg. Qty.
11602	Combo Head - #8 x 1/2		100 Box
11606	Combo Head - #8 x 1		100 Box
11610	Combo Head - #8 x 1-1/2		100 Box
11612	Combo Head - #8 x 2		100 Box
11620	Combo Head - #10 x 1		100 Box
11624	Combo Head - #10 x 1-1/4		100 Box
11628	Combo Head - #10 x 1-1/2		100 Box
11632	Combo Head - #10 x 2		100 Box
11644	Combo Head - #12 x 1		100 Box
11648	Combo Head - #12 x 1-1/4		100 Box
11652	Combo Head - #12 x 1-1/2		100 Box
11656	Combo Head - #12 x 2		100 Box
11672	Combo Head - #14 x 1-1/4		100 Box
11676	Combo Head - #14 x 1-1/2		100 Box
11680	Combo Head - #14 x 2		100 Box
11625	Combo Head-# 14 x 3		100Box

Perfect when color matching is a must!  
Ideal for use with colored gutters and  
downspouts!

# Painted Speed Screws

Self-Piercing – 1/4" Hex Head Slotted

Bar Code Number	Item Description	Size	Color	Package Quantity
10814	Painted Speed Screw - #6 x 3/8 - Almond			100 Box
10840	Painted Speed Screw - #6 x 3/8 - Almond			1000 PL Box
10866	Painted Speed Screw - #7 x 1/2- Almond			100 Box
10892	Painted Speed Screw - #7 x 1/2- Almond			1000 PL Box
10808	Painted Speed Screw - #6 x 3/8" Antique Ivory			100 Box
10834	Painted Speed Screw - #6 x 3/8" Antique Ivory			1000 PL Box
10801	Painted Speed Screw - #6 x 3/8" Black			100 Box
10803	Painted Speed Screw - #6 x 3/8" Black			1000 PL Box
32040	Painted Speed Screw - #7 x 1/2" Black			100 Box
	Painted Speed Screw - #6 x 3/8" Bronze			See Terratone
10816	Painted Speed Screw - #6 x 3/8 - Brown / Royal Brown			100 Box
10842	Painted Speed Screw - #6 x 3/8 - Brown / Royal Brown			1000 PL Box
10868	Painted Speed Screw - #7 x 1/2 - Brown / Royal Brown			100 Box
10894	Painted Speed Screw - #7 x 1/2 - Brown / Royal Brown			1000 PI Box
10819	Painted Speed Screw - #8 x 1/2- Brown / Royal Brown			100 Box
10914	Painted Speed Screw - #8 x 1/2 - Brown / Royal Brown			1000 PL Box
10843	Painted Speed Screw - #8 x 3/4 - Brown / Royal Brown			100 Box
10867	Painted Speed Screw - #8 x 3/4 - Brown / Royal Brown			1000 PL Box
10835	Painted Speed Screw - #8 x 1 - Brown / Royal Brown			100 Box
10879	Painted Speed Screw - #8 x 1 - Brown / Royal Brown			500 PL Box
10824	Painted Speed Screw - #6 x 3/8 - Clay			100 Box
10850	Painted Speed Screw - #6 x 3/8 - Clay			1000 PL Box
10876	Painted Speed Screw - #7 x 1/2 - Clay			100 Box
10902	Painted Speed Screw - #7 x 1/2 - Clay			1000 PL Box
10825	Painted Speed Screw - #6 x 3/8 Cranberry			100 Box
10827	Painted Speed Screw - #6 x 3/8 Cranberry			1000 PI Box
32042	Painted Speed Screw - #7 x 1/2 Cranberry			100 Box
32050	Painted Speed Screw - #6 x 3/8 Cream			100 Box
10877	Painted Speed Screw - #7 x 1/2 Dark Bronze			100 Box
10997	Painted Speed Screw - #7 x 1/2 Desert Sand			100 Box
10992	Painted Speed Screw - #7 x 1/2 Desert Sand			1000 PL Box
10828	Painted Speed Screw - #6 x 3/8—Gray			100 Box
10854	Painted Speed Screw - #6 x 3/8—Gray			1000 PL Box
10853	Painted Speed Screw - #7 x 1/2—Gray			100 Box
10865	Painted Speed Screw - #7 x 1/2—Gray			1000 PL Box
10829	Painted Speed Screw - #6 x 3/8—Grecian Green			100 Box
10831	Painted Speed Screw - #6 x 3/8—Grecian Green			1000 PI Box
32044	Painted Speed Screw - #7 x 1/2—Grecian Green			100 Box
10813	Painted Speed Screw - #6 x 3/8- Herringbone			100 Box
10815	Painted Speed Screw - #6 x 3/8—Herringbone			1000 PL Box
10810	Painted Speed Screw - #6 x 3/8- Musket Brown			100 Box
10839	Painted Speed Screw - #6 x 3/8- Musket Brown			1000 PL Box
10855	Painted Speed Screw - #7 x 1/2- Musket Brown			100 Box
10888	Painted Speed Screw - #7 x 1/2- Musket Brown			1000 PL Box
10841	Painted Speed Screw - #8 x 3/4- Musket Brown			100 Box

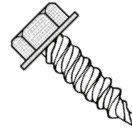
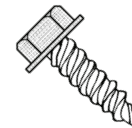
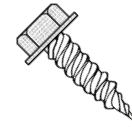

Other sizes available. Call for pricing.

Worried about color match? No problem!  
Call Shook and request samples  
for color matching. If our stock  
colors don't match, custom  
painting is available.



## Painted Speed Screws...Continued

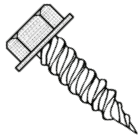

Bar Code Number	Item Description	Size	Color	Package Quantity
10822	Painted Speed Screw	#6 x 3/8	Terratone / Bronze	100 Box
10859	Painted Speed Screw	#6 x 3/8	Terratone / Bronze	1000 Box
10873	Painted Speed Screw	#7 x 1/2	Terratone / Bronze	100 Box
10875	Painted Speed Screw	#7 x 1/2	Terratone / Bronze	1000 PL Box
10832	Painted Speed Screw	#6 x 3/8	White	100 Box
10858	Painted Speed Screw	#6 x 3/8	White	1000 PL Box
10817	Painted Speed Screw	#6 x 3/8	White	20 M Bulk
10883	Painted Speed Screw	#6 x 3/8	White	20 M Jiffy Pail
10884	Painted Speed Screw	#7 x 1/2	White	100 Box
10910	Painted Speed Screw	#7 x 1/2	White	1000 PI Box
10885	Painted Speed Screw	#7 x 1/2	White	15M Jiffy Pail
10857	Painted Speed Screw	#7 x 1/2	White	15M Bulk
10911	Painted Stainless Steel Speed Screw	#7 x 1/2	White	100 bag
10826	Painted Speed Screw	#6 x 3/8	Wicker	100 Box
10852	Painted Speed Screw	#6 x 3/8	Wicker	1000 PL Box
10878	Painted Speed Screw	#7 x 1/2	Wicker	100 Box
10877	Painted Speed Screw	#7 x 1/2	Wicker	1000 PL Box
10851	Painted Speed Screw	#8 x 3/4	Wicker	100 Box
10849	Painted Speed Screw	#8 x 3/4	Wicker	1000 PL Box
10938	Painted Speed Screw	#8 x 1/2	White	100 Box
10912	Painted Speed Screw	#8 x 1/2	White	1000 PL Box
10940	Painted Speed Screw	#8 x 3/4	White	100 Box
10821	Painted Speed Screw	#8 x 3/4	White	1000 PL Box
10942	Painted Speed Screw	#8 x 1	White	100 Box
10823	Painted Speed Screw	#8 x 1	White	500 Box

Zinc Plated



## Phillips Flat Head Wood Screws

Bar Code Number	Item Description	Size	Package Quantity
11748	Wood Screw	#10 x 1-1/2	100 Box
11728	Wood Screw	#12 x 1-1/2	25 HP
11726	Wood Screw	#12 x 1-1/2	100 Box
11730	Wood Screw	#12 x 2	100 Box
11734	Wood Screw	#12 x 2-1/2	100 Box
11738	Wood Screw	#12 x 3	100 Box
11744	Wood Screw	#14 x 2	100 Box
11746	Wood Screw	#14 x 2-1/2	100 Box

## Framing Screws

Phillips Pan Head - Sharp Point

USED IN CONSTRUCTION AND METAL BUILDING TRADES

Bar Code Number	Item Description	Size	Package Qty.
11824	Framing Screw	# 6 x 7/16	100 Box
11826	Framing Screw	# 6 x 7/16	500 Box

Phillips Head - Driltip

11832	Framing Screw	# 7 x 7/16	500 Box
-------	---------------	------------	---------



## Drywall/Construction Screws



### Phillips Bugle Head - Coarse Thread - Black

Sharp points-Fast insertion

Bar Code Number	Size	Pkg. Qty.	Square Drive Bugle Head - Coarse Thread - Black																																
11914	#6 x 1"	100 Box	<table border="1"> <thead> <tr> <th>Bar Code</th> <th>Size</th> <th>Pkg Qty</th> </tr> </thead> <tbody> <tr> <td>11956</td> <td>#6 x 1-5/8"</td> <td>5M Bulk</td> </tr> <tr> <td>11958</td> <td>#6 x 2"</td> <td>4M Bulk</td> </tr> </tbody> </table>			Bar Code	Size	Pkg Qty	11956	#6 x 1-5/8"	5M Bulk	11958	#6 x 2"	4M Bulk																					
Bar Code	Size	Pkg Qty																																	
11956	#6 x 1-5/8"	5M Bulk																																	
11958	#6 x 2"	4M Bulk																																	
11886	#6 x 1"	500 Box																																	
11916	#6 x 1-1/8"	100 Box	<h3>Phillips Bugle Head - Fine Thread - Black</h3> <table border="1"> <tbody> <tr><td>11902</td><td>#6 x 1"</td><td>100 Box</td></tr> <tr><td>11904</td><td>#6 x 1-1/8"</td><td>100 Box</td></tr> <tr><td>11906</td><td>#6 x 1-1/4"</td><td>100 Box</td></tr> <tr><td>11908</td><td>#6 x 1-5/8"</td><td>100 Box</td></tr> <tr><td>11842</td><td>#6 x 1-5/8"</td><td>5M Bulk</td></tr> <tr><td>11910</td><td>#6 x 2"</td><td>100 Box</td></tr> <tr><td>11844</td><td>#6 x 2"</td><td>3.5M Bulk</td></tr> <tr><td>11912</td><td>#6 x 2-1/4"</td><td>100 Box</td></tr> <tr><td>11882</td><td>#8 x 2-1/2"</td><td>100 Box</td></tr> <tr><td>11884</td><td>#8 x 3"</td><td>100 Box</td></tr> </tbody> </table>			11902	#6 x 1"	100 Box	11904	#6 x 1-1/8"	100 Box	11906	#6 x 1-1/4"	100 Box	11908	#6 x 1-5/8"	100 Box	11842	#6 x 1-5/8"	5M Bulk	11910	#6 x 2"	100 Box	11844	#6 x 2"	3.5M Bulk	11912	#6 x 2-1/4"	100 Box	11882	#8 x 2-1/2"	100 Box	11884	#8 x 3"	100 Box
11902	#6 x 1"	100 Box																																	
11904	#6 x 1-1/8"	100 Box																																	
11906	#6 x 1-1/4"	100 Box																																	
11908	#6 x 1-5/8"	100 Box																																	
11842	#6 x 1-5/8"	5M Bulk																																	
11910	#6 x 2"	100 Box																																	
11844	#6 x 2"	3.5M Bulk																																	
11912	#6 x 2-1/4"	100 Box																																	
11882	#8 x 2-1/2"	100 Box																																	
11884	#8 x 3"	100 Box																																	
11888	#6 x 1-1/8"	500 Box																																	
11919	#6 x 1-1/4"	25 HP																																	
11918	#6 x 1-1/4"	100 Box																																	
11890	#6 x 1-1/4"	500 Box																																	
11920	#6 x 1-5/8"	100 Box																																	
11892	#6 x 1-5/8"	500 Box																																	
11858	#6 x 1-5/8"	5M Bulk																																	
11923	#6 x 2"	25 HP																																	
11922	#6 x 2"	100 Box																																	
11895	#6 x 2"	250 Box																																	
11924	#6 x 2-1/4"	100 Box																																	
11896	#6 x 2-1/4"	250 Box																																	
11899	#8 x 2-1/2"	25 HP																																	
11898	#8 x 2-1/2"	100 Box																																	
11891	#8 x 2-1/2"	250 Box																																	
11893	#8 x 2-1/2"	500 Box																																	
11900	#8 x 3"	100 Box																																	
11894	#8 x 3"	500 Box																																	
			<h3>Phillips Bugle Head - Black, Drill Point</h3> <table border="1"> <tbody> <tr><td>11930</td><td>#6 x 1-5/8"</td><td>5 M Bulk</td></tr> <tr><td>11942</td><td>#8 x 2-3/8"</td><td>100 Box</td></tr> <tr><td>11944</td><td>#8 x 3"</td><td>100 Box</td></tr> </tbody> </table>			11930	#6 x 1-5/8"	5 M Bulk	11942	#8 x 2-3/8"	100 Box	11944	#8 x 3"	100 Box																					
11930	#6 x 1-5/8"	5 M Bulk																																	
11942	#8 x 2-3/8"	100 Box																																	
11944	#8 x 3"	100 Box																																	



## Deck Screws

Phillips Bugle Head - Coarse Thread -  
Dacrotized for Rust Resistance

Bar Code Number	Item Description	Size	Package Quantity	<p>-Coarse thread -Sharp points -Fast insertion -Holds tight</p>
01516	Deck Screw - Dacrotized - #6 x 1-1/4"		100 Box	
01519	Deck Screw - Dacrotized - #6 x 1-5/8"		25 HP	
01518	Deck Screw - Dacrotized - #6 x 1-5/8"		100 Box	
01528	Deck Screw - Dacrotized - #6 x 1-5/8"		500 Box	
01521	Deck Screw - Dacrotized - #6 x 2"		25 HP	
01520	Deck Screw - Dacrotized - #6 x 2"		100 Box	
01530	Deck Screw - Dacrotized - #6 x 2"		500 Box	
01523	Deck Screw - Dacrotized - #8 x 2-1/2"		25 HP	
01522	Deck Screw - Dacrotized - #8 x 2-1/2"		100 Box	
01532	Deck Screw - Dacrotized - #8 x 2-1/2"		500 Box	
01525	Deck Screw - Dacrotized - #8 x 3"		25 HP	
01524	Deck Screw - Dacrotized - #8 x 3"		100 Box	
01534	Deck Screw - Dacrotized - #8 x 3"		500 Box	

# Concrete Screws

- No anchor required
- Rust resistant blue finish
- Also available in kits
- All 100 packs include masonry bit

## Hex Washer Head

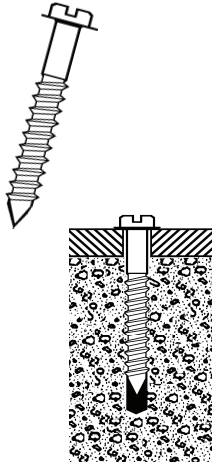

Bar Code Number	Item Description	Size	Reqd. Masonry Drill Bit Size	Drill Bit Included	Package Quantity
14700	Concrete Screw - 3/16" dia x 1-1/4" Long		5/32"	X	100 Box
14702	Concrete Screw - 3/16" dia x 1-3/4" Long		5/32"	X	100 Box
14705	Concrete Screw - 3/16" dia x 2-1/4" Long		5/32"		50 Box
14704	Concrete Screw - 3/16" dia x 2-1/4" Long		5/32"	X	100 Box
14709	Concrete Screw - 1/4" dia x 1-1/4" Long		3/16"		50 Box
14708	Concrete Screw - 1/4" dia x 1-1/4" Long		3/16"	X	100 Box
14711	Concrete Screw - 1/4" dia x 1-3/4" Long		3/16"		50 Box
14710	Concrete Screw - 1/4" dia x 1-3/4" Long		3/16"	X	100 Box
14713	Concrete Screw - 1/4" dia x 2-1/4" Long		3/16"		50 Box
14712	Concrete Screw - 1/4" dia x 2-1/4" Long		3/16"	X	100 Box
14715	Concrete Screw - 1/4" dia x 2-3/4" Long		3/16"		50 Box
14714	Concrete Screw - 1/4" dia x 2-3/4" Long		3/16"	X	100 Box
14716	Concrete Screw - 1/4" dia x 3-1/4" Long		3/16"	X	100 Box

## Phillips Flat Head Concrete Screws



Bar Code Number	Item Description	Size	Reqd. Masonry Drill Bit Size	Drill Bit Included	Pkg. Qty.
14730	Concrete Screw - 3/16" dia x 1-1/4" Long		5/32"	X	100 Box
14732	Concrete Screw - 3/16" dia x 1-3/4" Long		5/32"	X	100 Box
14734	Concrete Screw - 3/16" dia x 2-1/4" Long		5/32"	X	100 Box
14736	Concrete Screw - 3/16" dia x 2-3/4" Long		5/32"	X	100 Box
14741	Concrete Screw - 1/4" dia. x 1-3/4" Long		3/16"		50 Box
14740	Concrete Screw - 1/4" dia. x 1-3/4" Long		3/16"	X	100 Box
14743	Concrete Screw - 1/4" dia. x 2-1/4" Long		3/16"		50 Box

## Concrete Screw Drill Bits



Bar Code Number	Item Description	Size	Package Quantity
14762	Concrete Screw Drill Bit	5/32 x 3-1/2	1 Bulk
14763	Concrete Screw Drill Bit	5/32 x 3-1/2	1 POS
14764	Concrete Screw Drill Bit	5/32 x 4-1/2	1 Bulk
14765	Concrete Screw Drill Bit	5/32 x 4-1/2	1 POS
14766	Concrete Screw Drill Bit	3/16 x 3-1/2	1 Bulk
14767	Concrete Screw Drill Bit	3/16 x 3-1/2	1 POS
14768	Concrete Screw Drill Bit	3/16 x 4-1/2	1 Bulk
14769	Concrete Screw Drill Bit	3/16 x 4-1/2	1 POS
14770	Concrete Screw Drill Bit	3/16 x 5-1/2	1 Bulk
14771	Concrete Screw Drill Bit	3/16 x 5-1/2	1 POS

# Concrete Anchor Installation Kit



Bar Code Number	Item Description	Size	Package Quantity
14772	Concrete Anchor Kit -Complete Kit		1
<b>Accessories Included:</b>			
14774	1/4" Magnetic Driver		1
14776	5/16" Magnetic Driver		1
14778	Phillips Bit Adapter		1
14780	Masonry Bit Holder		1
14782	Sleeve		1
14784	1/8 Hex Key		1
14786	#2 Phillips Bit		1
14788	#3 Phillips Bit		1
14790	Carrying Case		1
14768	3/16 x 4-1/2 Masonry Bit		1

# Anchors

## SLEEVE ANCHORS

Includes nuts & washers

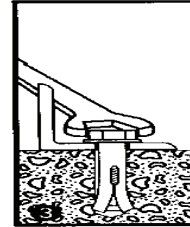
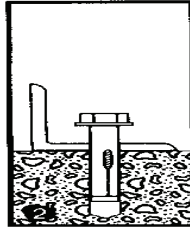
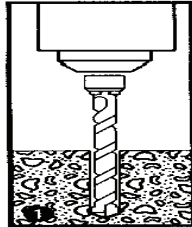

Zinc Plated

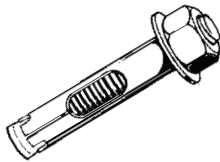

## DROP-IN ANCHORS

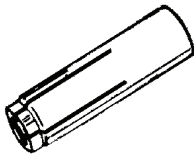

## SETTING TOOL

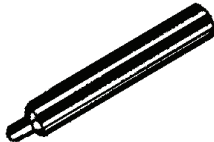

## ROD HANGER



Bar Code Number	Item Description	Anchor Size	Drill Size	Package Quantity
26104	Sleeve Anchor	- 3/8" x 1-7/8"	3/8"	100 Box
26106	Sleeve Anchor	- 3/8" x 3"	3/8"	100 Box
26110	Sleeve Anchor	- 1/2" x 2-1/4"	1/2"	50 Box

Meets or exceeds GSA Specification FF-S-325, Group VII, Type

ZINC PLATED

Bar Code Number	Item Description	Size	Drill Bit Req'd.	Package Quantity
26150	Drop-in Anchor	- 1/4"- 20	3/8"	100 Box
26152	Drop-in Anchor	- 3/8"- 16	1/2"	50 Box
26153	Drop-in Anchor	- 3/8"- 16	1/2"	100 Box
26154	Drop-in Anchor	- 1/2"- 13	5/8"	50 Box
26156	Drop-in Anchor	- 5/8"- 11	7/8"	25 Box
26158	Drop-in Anchor	- 3/4"- 10	1"	25 Box

Shook setting tool must be used to insure proper and safe installation

26160	Setting Tool	- 1/4"- 20		1 POS
26162	Setting Tool	- 3/8"- 16		1 POS
26164	Setting Tool	- 1/2"- 13		1 POS

Bar Code Number	Item Description	Size	Rod Size	Package Quantity
26134	Rod Hanger	- 3/8" x 1-7/8"	3/8" Rod	100 Box

**FAST** Order Line: 1-800-354-9792 FAX: 1-800-733-3882

**WEDGE ANCHORS-Includes NUTS & WASHERS**

Dome on top of Anchor to protect threads during installation.  
Full thread or longer threads on each side for rebar, machinery and other installations.

Bar Code Number	Item Description	Size	Package Quantity
26006	Wedge Anchor -	3/8 x 2-1/4"	100 Box
26008	Wedge Anchor -	3/8 x 2-3/4"	100 Box
26010	Wedge Anchor -	3/8 x 3"	100 Box
26012	Wedge Anchor -	3/8 x 3-3/4"	100 Box
26018	Wedge Anchor -	1/2 x 2-3/4"	50 Box
26038	Wedge Anchor -	5/8 x 5"	25 Box

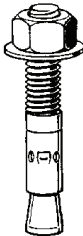

**HAMMER DRIVES- ZINC**

Meets or exceeds GSA specification FF-S-325  
Group VIII, Type 2, Class 3

Bar Code Number	Item Description	Size	Package Quantity
26172	Hammer Drive-	1/4" x 3/4"	100 Box
26174	Hammer Drive-	1/4" x 1"	100 Box
26176	Hammer Drive-	1/4" x 1-1/4"	100 Box
26178	Hammer Drive-	1/4" x 1-1/2"	100 Box
26180	Hammer Drive-	1/4" x 2"	100 Box

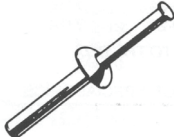

**Lag Shields**

Rustproof industrial quality  
Meets or exceeds GSA Spec. FF-S-325, Group II, Type 1, Class 1 & 2

Bar Code Number	Item Description	Size	Package Quantity
26280	Lag Shield-	3/8 long	50 Box



**Machine Screw Anchors**

Rustproof industrial quality  
Meets or exceeds GSA Spec. FF-S-325, Group II, Type 1, Class 1

Bar Code Number	Item Description	Size	Package Quantity
26306	1/4-20 x 15/16"		100
26310	3/8-16 x 1-3/8"		50
26312	1/2-13 x 1-9/16"		50



**Lead Anchor Kit**

26299	Lead Anchor Kit Contains:		
	10 x 1" Lead Anchors		100
	8 x 1" Combo Pan Head Tapping Screw		100
	5/16" x 4" Masonry Drill Bit		1
	#2 Phillips Insert Bit		1

## Round Head Stove Bolts with Hex Nuts

Zinc plated  
Combo head

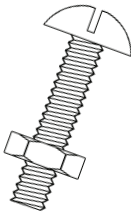

Bar Code Number	Item Description	Size	Package Quantity
12000	Stove Bolt with Hex Nut -	3/16 x 1/2 - 225-1	100 Box
12002	Stove Bolt with Hex Nut -	3/16 x 3/4 - 226-1	100 Box
12004	Stove Bolt with Hex Nut -	3/16 x 1 - 227-1	100 Box
12006	Stove Bolt with Hex Nut -	3/16 x 1-1/4 - 228-1	100 Box
12008	Stove Bolt with Hex Nut -	3/16 x 1-1/2 - 229-1	100 Box
12010	Stove Bolt with Hex Nut -	3/16 x 2 - 231-1	100 Box
12012	Stove Bolt with Hex Nut -	1/4 x 1/2 - 234-1	100 Box
12014	Stove Bolt with Hex Nut -	1/4 x 3/4 - 235-1	100 Box
12016	Stove Bolt with Hex Nut -	1/4 x 1 - 236-1	100 Box
12018	Stove Bolt with Hex Nut -	1/4 x 1-1/4 - 237-1	100 Box
12020	Stove Bolt with Hex Nut -	1/4 x 1-1/2 - 238-1	100 Box
12022	Stove Bolt with Hex Nut -	1/4 x 2 - 240-1	100 Box

## Flat Washers

### USS – Alloy Flat Washer

Bolt Size	O.D. A	I.D. B	Thick C
3/16"	9/16	1/4	3/64
1/4"	3/4	5/16	1/16
5/16"	7/8	3/8	5/64
3/8"	1.00	7/16	5/64
1/2"	1-3/8	9/16	7/64
5/8"	1-3/4	11/16	9/64
3/4"	2.00	13/16	5/32

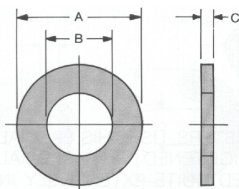

Alloy steel, hardened to RC 45-53

Zinc plated

Meets or exceeds ASME/ANSI B818.22.1

Bar Code Number	Item Description	Size	Package Quantity
12468	USS Flat Washer -	3/16"	100 Box
12471	USS Flat Washer -	1/4"	25 HP
12470	USS Flat Washer -	1/4"	100 Box
12472	USS Flat Washer -	5/16"	100 Box
12475	USS Flat Washer -	3/8"	25 HP
12474	USS Flat Washer -	3/8"	100 Box
12476	USS Flat Washer -	1/2"	100 Box
12478	USS Flat Washer -	5/8"	100 Box
12480	USS Flat Washer -	3/4"	100 Box

### SAE – Alloy Flat Washer

Alloy steel, hardened to RC 45-53

Zinc plated

Meets or exceeds ASME/ANSI B818.22.1

Bolt Size	O.D. A	I.D. B	Thick C
#6	3/8	1/64	3/64
#8	7/16	3/16	3/64
#10	1/2	7/32	3/64
1/4"	5/8	9/32	1/16
5/16"	11/16	11/32	1/16
3/8"	13/16	13/32	1/16
1/2"	1-1/16	17/32	3/32
5/8"	1-5/16	21/32	3/32

12432	SAE Flat Washer - #8 -	(3/16") ID x 7/16" OD x 3/64" Thk.	100 Box
12434	SAE Flat Washer - #10 -	(7/32") ID x 1/2" OD x 3/64" Thk.	100 Box
12436	SAE Flat Washer - 1/4" -	(9/32") ID x 5/8" OD x 1/16" Thk.	100 Box
12438	SAE Flat Washer - 5/16" -	(11/32") ID x 11/16" OD x 1/16"	100 Box
12440	SAE Flat Washer - 3/8" -	(13/32") ID x 13/16" OD x 1/16"	100 Box
12442	SAE Flat Washer - 1/2" -	(17/32") ID x 1-1/16" OD x 3/32"	100 Box

## Machine Screw Hex Nuts

Zinc plated

Bar Code Number	Item Description	Size	Package Quantity
12406	Hex Nut, Machine Screw	#10-32	100 Box

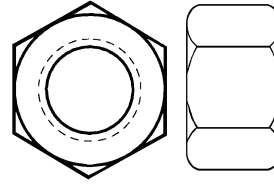

## Finished Hex Nuts

Zinc plated

Bar Code Number	Item Description	Size	Package Quantity
12409	Hex Nut, Finished	1/4-20	25 HP
12408	Hex Nut, Finished	1/4-20	100 Box
12433	Hex Nut, Finished	1/4-20	500
12410	Hex Nut, Finished	5/16-18	100 Box
12413	Hex Nut, Finished	3/8-16	25 HP
12412	Hex Nut, Finished	3/8-16	100 Box
12420	Hex Nut, Finished	3/8-16	250
12421	Hex Nut, Finished	3/8-16	1000
12414	Hex Nut, Finished	1/2-13	50 Box
12416	Hex Nut, Finished	5/8-11	25 Box
12418	Hex Nut, Finished	3/4-10	20 Box

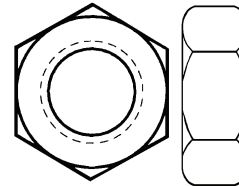

## Wing Nuts

Stamped Wing Nuts

Bar Code Number	Item Description	Size	Package Quantity
12422	Stamped Wing Nut	1/4 - 20	100 Box
12424	Stamped Wing Nut	5/16 - 18	100 Box

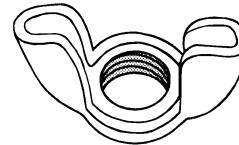

## Nylon Insert Lock Nuts

Bar Code Number	Item Description	Size	Package Quantity
12927	Nylon Insert Locknut	3/8-16	100



## Heavy Hex Nuts

Bar Code Number	Item Description	Size	Package Quantity
12933	Heavy Hex Nut	3/8-16	100
12939	Heavy Hex Nut	1/2-13	100

Grade 2 steel

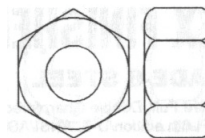

## Grade 5 Hex Nuts

Bar Code Number	Item Description	Size	Package Quantity
12941	Grade 5 Hex Nut	1/4-20	100
12943	Grade 5 Hex Nut	5/16-18	100
12945	Grade 5 Hex Nut	3/8-16	100
12947	Grade 5 Hex Nut	1/2-13	100

Grade 5 steel  
Zinc plated

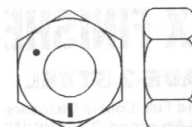

## Fender Washers

Bar Code Number	Item Description	Size	Package Quantity
12485	Fender Washer - 3/16"	I.D. - 1-1/4" O.D.	100 Box
12487	Fender Washer - 1/4"	I.D. - 1" O.D.	25 HP
12486	Fender Washer - 1/4"	I.D. - 1" O.D.	100 Box
12488	Fender Washer - 1/4"	I.D. - 1-1/4" O.D.	100 Box
12490	Fender Washer - 1/4"	I.D. - 1-1/2" O.D.	100 Box
12495	Fender Washer - 3/8"	I.D. - 1-1/4" O.D.	25 HP
12493	Fender Washer - 3/8"	I.D. - 1-1/4" O.D.	100 Box
12497	Fender Washer - 3/8"	I.D. - 1-1/2" O.D.	25 HP
12494	Fender Washer - 3/8"	I.D. - 1-1/2" O.D.	100 Box
12496	Fender Washer - 1/2"	I.D. - 2" O.D.	100 Box

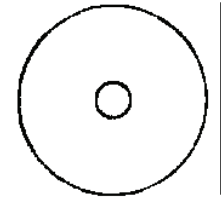

## Lock Washers

Bar Code Number	Item Description	Size	Package Quantity
12455	Lock Washer - 1/4"	I.D.	25 HP
12454	Lock Washer - 1/4"	I.D.	100 Box
12456	Lock Washer - 5/16"	I.D.	100 Box
12459	Lock Washer - 3/8"	I.D.	25 HP
12458	Lock Washer - 3/8"	I.D.	100 Box
12460	Lock Washer - 1/2"	I.D.	100 Box
12463	Lock Washer - 5/8"	I.D.	25 Box



## "Jiffy" Rivets

### Steel Rivet - Steel Mandrel

#### 1/8" Rivet Diameter

Bar Code Number	Grip Range	Marson Part #	Package Quantity
13214	1/32" to 1/16"	SB4-1-5	500 Box
13102	1/16" to 1/8"	SB4-2-1	100 Box
13104	1/16" to 1/8"	SB4-2-5	500 Box
13106	1/16" to 1/8"	SB4-2-E	1000 Box
13100	1/16" to 1/8"	SB4-2	10M Bulk
13110	1/8" to 3/16"	SB4-3-1	100 Box
13114	1/8" to 3/16"	SB4-3-E	1000 Box
13118	3/16" to 1/4"	SB4-4-1	100 Box
13120	3/16" to 1/4"	SB4-4-5	500 Box
13122	3/16" to 1/4"	SB4-4-E	1000 Box
13116	3/16" to 1/4"	SB4-4	10M Bulk
13136	5/16" to 3/8"	SB4-6-5	500 Box
13138	5/16" to 3/8"	SB4-6-E	1000 Box
13144	7/16" to 1/2"	SB4-8-5	500 Box

#### 3/16" Rivet Diameter

13158	3/16" to 1/4"	SB6-4	5M Bulk
-------	---------------	-------	---------

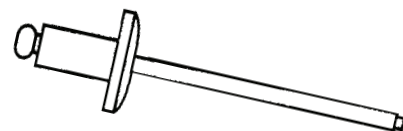
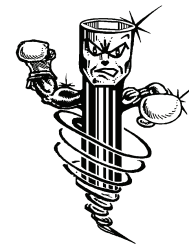



**“Jiffy” Rivets...continued****Aluminum Rivet - Aluminum Mandrel****1/8" Rivet Diameter**

Bar Code Number	Grip Range	Marson Part#	Package Quantity
13304	1/16" to 1/8"	AB4-2A-5	500 Box
13306	1/16" to 1/8"	AB4-2A-E	1000 Box
13300	1/16" to 1/8"	AB4-2A	10M Bulk
13456	1/8" to 3/16"	AB4-3A-5	500 Box
13458	1/8" to 3/16"	AB4-3A-E	1000 Box
13452	1/8" to 3/16"	AB4-3A	10M Bulk
13312	3/16" to 1/4"	AB4-4A-5	500 Box
13314	3/16" to 1/4"	AB4-4A-E	1000 Box
13330	5/16" to 3/8"	AB4-6A-5	500 Box
13334	7/16" to 1/2"	AB4-8A	10M Bulk
13358	3/16" to 1/4"	AB5-4A	5M Bulk

**Copper Rivet - Steel Mandrel**

Bar Code Number	Grip Range	Marson Part#	Package Quantity
13704	1/16" to 1/8"	CB 4-2C-5	500 Box
13700	1/16" to 1/8"	CB 4-2C	10M Bulk
13702	1/16" to 1/8"	CB 4-2C-1	100 Box
13706	1/16" to 1/8"	CB 4-2C-E	1000 Box
13712	3/16" to 1/4"	CB 4-4C-5	500 Box
13714	3/16" to 1/4"	CB 4-4C-E	1000 Box
13708	3/16" to 1/4"	CB 4-4C	10M Bulk

**Stainless Steel Rivet -  
Stainless Steel Mandrel 1/8" Rivet Diameter**

Bar Code Number	Grip Range	Marson Part#	Package Quantity
13658	1/16" to 1/8"	SSB4-2S-1	100 Box
13660	1/16" to 1/8"	SSB4-2S-5	500 Box
13662	1/16" to 1/8"	SSB4-2S-E	1000 Box
13666	1/8" to 3/16"	SSB4-3S-1	100 Box
13668	1/8" to 3/16"	SSB4-3S-5	500 Box
13670	1/8" to 3/16"	SSB4-2S-E	1000 Box
13674	3/16" to 1/4"	SSB4-4S-1	100 Box
13676	3/16" to 1/4"	SSB4-4S-5	500 Box
13678	3/16" to 1/4"	SSB4-4S-E	1000 Box
13684	5/16" to 3/8"	SSB4-6S-5	500 Box

**Painted Rivets  
Aluminum Rivet - Aluminum Mandrel 1/8" Rivet Diameter**

13460	White	AB4-2A	1/16 to 1/8	10M Bulk
13464	White	AB4-2A-5	1/16 to 1/8	500 Box
13488	Brown	AB4-2A-5	1/16 to 1/8	500 Box

**Hand Rivet Tools**

Bar Code Number	Item Description	Package Quantity
13000	Heavy Duty Hand Riveter	1 Bulk

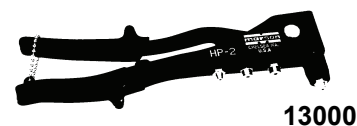
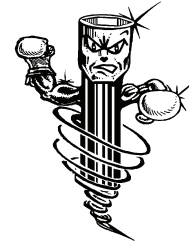

# Threaded Rod

Zinc Plated

Sold in full bundles only

PLEASE CALL FOR CURRENT PRICING

Bar Code Number	Item Description	Size	Package Quantity
21004	Threaded Rod - 3/8-16	x 3'	20 pcs./bundle
21006	Threaded Rod - 3/8-16	x 6'	20 pcs./bundle
21008	Threaded Rod - 1/2-13	x 3'	20 pcs./bundle
21010	Threaded Rod - 1/2-13	x 6'	20 pcs./bundle

NOTE: DUE TO THE HIGH COST OF SHIPPING, THREADED ROD IS NOT ELIGIBLE FOR FREIGHT ALLOWED ORDERS.



## Coupling Nuts

Bar Code Number	Item Description	Size	Pkg. Qty.
21020	Coupling Nuts - 1/4"-20	x 7/8"	100
21023	Coupling Nuts - 5/16"-18	x 1-1/8"	50
21022	Coupling Nuts - 3/8"-16	x 1-1/8"	50
21025	Coupling Nut Reducer - 3/8"	to 5/16"	50

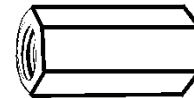

## Jiffy" Threaded Rod Cutter

Precision clean cut design protects threads

No cleaning threads- Just screw on nuts Easy to replace blade

Bar Code Number	Item Description	Size	Pkg. Qty.
15359	Threaded Rod Cutter-	3/8"	1
15361	Dies for Threaded Rod Cutter		1
15365	Dual Threaded Rod Cutter-	3/8" & 1/2"	1
15363	Ratcheting Threaded Rod Cutter-	3/8"	1

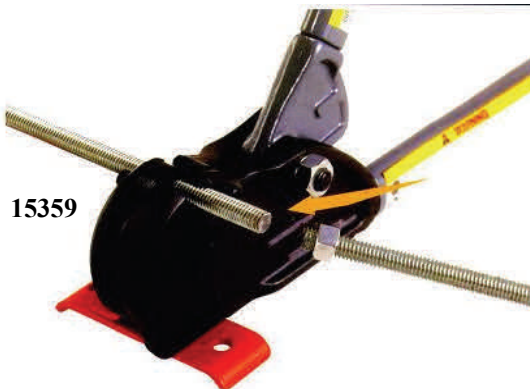

# Round Head Toggle Bolt Anchors with Wings

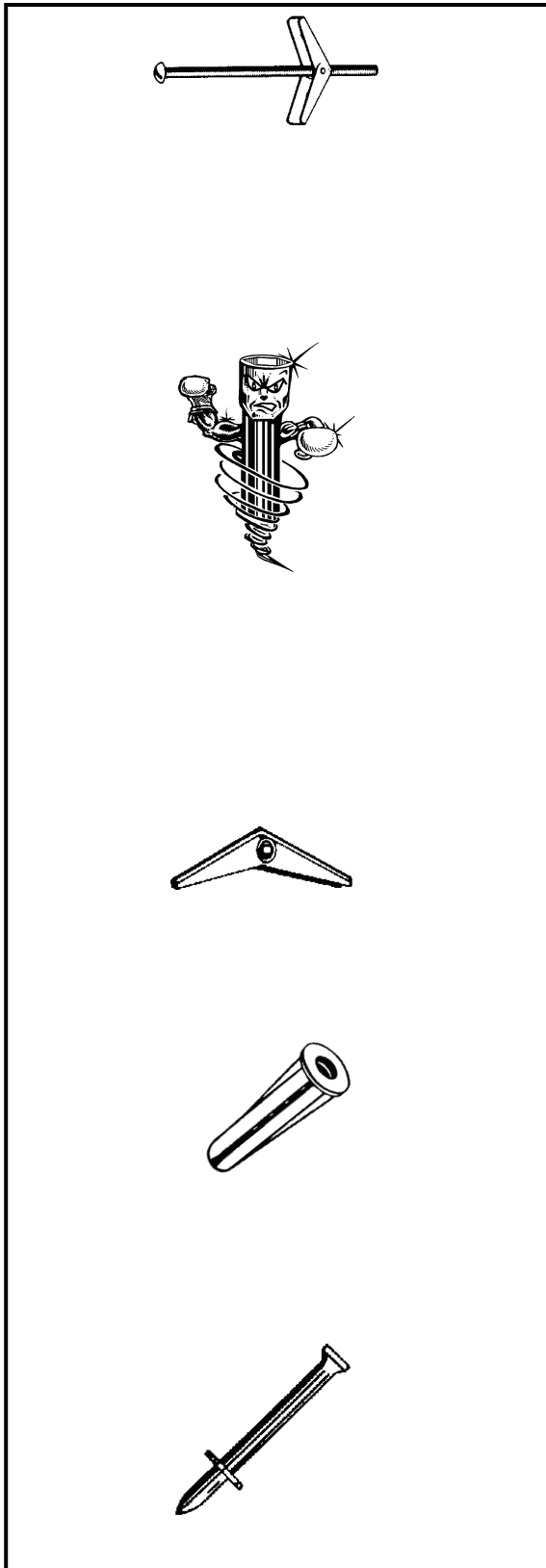

### 1/8" Dia.

12200	Bolt w/ Wings—1/8 x 2	3/8	100 Box
12202	Bolt w/ Wings—1/8 x 3	3/8	100 Box
12204	Bolt w/ Wings—1/8 x 4	3/8	100 Box

### 3/16" Dia.

12206	Bolt w/ Wings—3/16 x 2	9/16	100 Box
12208	Bolt w/ Wings - 3/16 x 3	9/16	100 Box
12209	Bolt w/ Wings—3/16 x 3	9/16	25 POS
12210	Bolt w/ Wings - 3/16 x 4	9/16	50 Box
12211	Bolt w/ Wings—3/16 x 4	9/16	10 POS

### 1/4", 5/16", 3/8" Dia.

Bar Code Number	Item Description	Bolt Size	Drill Bit Dia.	Pkg. Qty.
12216	Bolt w/ Wings - 1/4 x 3		3/4"	50 Box
12218	Bolt w/ Wings - 1/4 x 4		3/4"	50 Box
12222	Bolt w/ Wings - 1/4 x 6		3/4"	50 Box
12224	Bolt w/ Wings—5/16 x 3		7/8"	25 Box
12232	Bolt w/ Wings—3/8 x 3		1"	25 Box
12234	Bolt w/ Wings - 3/8 x 4		1"	25 Box
12238	Bolt w/ Wings - 3/8 x 6		1"	25 Box

## ZINC PLATED Toggle Wings

Bar Code Number	Item Description	Size	Drill Bit Dia.	Pkg. Qty.
12334	Wings Only	3/16"	9/16"	50 Box
12338	Wings Only	1/4"	3/4"	100 Box
12346	Wings On;y	3/8"	1"	50 Box

## Conical Plastic Wall Anchors

12276	Conical Wall Anchor - #8 - 10 x 7/8	460-1	3/16"	100 Box
12278	Conical Wall Anchor - #8 - 10 x 7/8"	460-E	3/16"	1000 Box
12280	Conical Wall Anchor - #10 - 12 x 1"	461-1	1/4"	100 Box
12282	Conical Wall Anchor - #10 - 12 x 1"	461-5	1/4"	500 Box
12284	Conical Wall Anchor - #14 - 16 x 1-1/2"	462-1	5/16"	100 Box

## Drive Pins

Bar Code Number	Item Description	Size	Package Quantity
12302	Drive Pin - 7/8" Shank Length		100 HP
12308	Drive Pin - 1" Shank Length		50 HP
12306	Drive Pin - 1" Shank Length		100 HP
12310	Drive Pin - 1-1/4" Shank Length		100 HP
12312	Drive Pin - 1-1/2" Shank Length		100 Box
12314	Drive Pin - 2" Shank Length		100 Box
12320	Drive Pin Setting Tool		1

# Anchor Kits

## CONICAL PLASTIC ANCHORS

Combo phillips/slotted pan head or combo hex washer head sheet metal screws

Masonry drill bit included in selected kits

Packaged in 2 compartment plastic box or plastic jar with screw top lid



Bar Code Number	Item Description	Size		Screw Size	Screw (Type)	Drill Bit Dia.	Pkg. Qty.
<b>12500</b>	Anchor Kit	<b>3/16 x 3/4</b>	464	6 x 3/4	Pan Combo	3/16"	100 Box
<b>12502</b>	Anchor Kit	<b>3/16 x 7/8</b>	465	8 x 1	Pan Combo	3/16"	100 Box
12503	Anchor Kit	<b>3/16 x 7/8</b>	465-J	8 x 1	Pan Combo	3/16"	100 Jar
<b>12504</b>	Anchor Kit	<b>1/4 x 1</b>	466-1	10 x 1	Pan Combo	1/4"	100 Box
<b>12506</b>	Anchor Kit	<b>1/4 x 1</b>	466	10 x 1-1/4	Pan Combo	1/4"	100 Box
<b>12509</b>	Anchor Kit	<b>1/4 x 1</b>	466-J	10 x 1-1/4	Pan Combo	1/4"	100 PL Jar
<b>12514</b>	Anchor Kit	<b>1/4 x 1</b>	466-2	10 x 1-1/4	Pan Combo	1/4"	200 PL Box
12512	Anchor Kit	<b>1/4 x 1</b>	466-12	10 x 1-1/4	Pan Combo	1/4"	200 PL Box
12510	Anchor Kit	<b>5/16 x 1-1/4</b>		12 x 1-1/4	Pan Combo	5/16"	50 Box
<b>12508</b>	Anchor Kit	<b>5/16 x 1-3/8</b>	467	14 x 1-1/2	Pan Combo	5/16"	50 Box
12513	Anchor Kit	<b>5/16 x 1-3/8</b>	467-J	14 x 1-1/2	Pan Combo	5/16"	50 PL Jar
<b>12524</b>	Anchor Kit	<b>3/16 x 7/8</b>	470	8 x 1	Combo Hex Washer Head	3/16"	100 Box
<b>12526</b>	Anchor Kit	<b>1/4 x 1</b>	471-1	10 x 1 (1/4)	Combo Hex Washer Head	1/4"	100 Box
<b>12529</b>	Anchor Kit	<b>1/4 x 1</b>		10 x 1 (5/16)	Combo Hex Washer Head	1/4"	100 Box
12527	Anchor Kit	<b>1/4 x 1</b>		10 x 1 (5/16)	Combo Hex Washer Head	1/4"	100 Jar
12528	Anchor Kit	<b>1/4 x 1</b>	471-S1	10 x 1 (5/16)	Combo Hex Washer Head	1/4"	100 Box
<b>12533</b>	Anchor Kit	<b>1/4 x 1</b>		10 x 1 (5/16)	Combo Hex Washer Head	1/4"	100 Jar
<b>12530</b>	Anchor Kit	<b>1/4 x 1</b>	471	10 x 1-1/4 (1/4)	Combo Hex Washer Head	1/4"	100 Box
<b>12532</b>	Anchor Kit	<b>1/4 x 1</b>	471-S	10 x 1-1/4 (5/16)	Combo Hex Washer Head	1/4"	100 Box
12534	Anchor Kit	<b>1/4 x 1</b>	471-2	10 x 1-1/2	Combo Hex Washer Head	1/4"	100 Box
<b>12536</b>	Anchor Kit	<b>5/16 x 1-3/8</b>	472	14 x 1-1/2	Hex Washer Head	5/16"	50 Box
<b>12690</b>	Anchor Kit Assortment– Contains 6 Each Of 8 Popular Anchor Kits– 12500, 12502, 12504, 12506, 12526, 12530, 12570, 12572 ( 12570, 12572– See Page 49)						

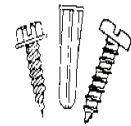

NOTE: ITEMS IN BOLD DENOTE OUR MOST POPULAR SIZES

# Jiffy EZ Anchor Kits

## DRYWALL ANCHOR KITS

ALL KITS PACKAGED IN PLASTIC BOX OR JAR

Metal or nylon drywall anchors • Pan head combo phillips/slotted screws • No masonry



Bar Code Number	Item Description	Anchor Material	Screw Size	Screw (Type)	Package Quantity
12352	Jiffy EZ Drywall Anchor	PLASTIC	8 x 1-1/4	Pan Com-bo	50 Box
12356	Jiffy EZ Drywall Anchor	METAL	8 x 1-1/4	Pan Com-bo	50 Box
<b>12570</b>	Jiffy EZ Drywall Anchor	PLASTIC	<b>8 x 1</b>	Pan Com-bo	25 Box
<b>12572</b>	Jiffy EZ Drywall Anchor	METAL	<b>8 x 1</b>	Pan Com-bo	25 Box
12574	Jiffy EZ Drywall Anchor	PLASTIC	<b>8 x 1</b>	Pan Com-bo	50 Box
12576	Jiffy EZ Drywall Anchor	METAL	<b>8 x 1</b>	Pan Com-bo	50 Box
12578	Jiffy EZ Drywall Anchor	PLASTIC	ANCHORS ONLY		100 Box
12580	Jiffy EZ Drywall Anchor	METAL	ANCHORS ONLY		100 Box

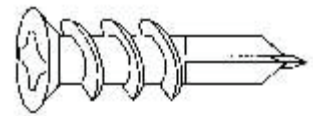

NOTE: ITEMS IN BOLD DENOTE OUR MOST POPULAR SIZES

## RIBBED ANCHOR KITS

Combo phillips/slotted pan head or hex washer head sheet metal screws  
Masonry drill bit included in selected kits

Bar Code Number	Item Description	Size	Screw Size	Screw (Type)	Drill Bit Dia.	Pkg. Qty.
<b>14502</b>	Ribbed Plastic Anchor - 3/16 x 7/8		8 x 1	Pan Combo	3/16"	100 Box
<b>14548</b>	Ribbed Plastic Anchor	<b>1/4 x 1</b>	10 x 1	Pan Combo	1/4"	100 Box
<b>14506</b>	Ribbed Plastic Anchor	<b>1/4 x 1</b>	10 x 1-1/4	Pan Combo	1/4"	100 Box

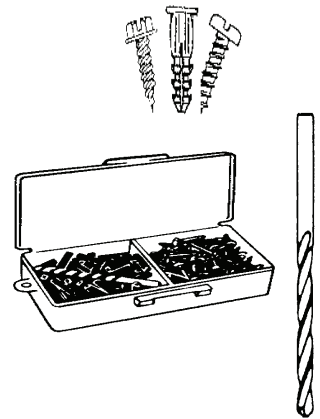

## VINYL TUBE ANCHOR KITS

Combo phillips/slotted pan head or hex washer head sheet metal screws  
Masonry drill bit included in kits

Bar Code Number	Item Description	Color	Vinyl Tube Anchor	Screw Size	Screw (Type)	Drill Dia.	Pkg. Qty.
<b>12552</b>	Vinyl Tube Anchor - Green		<b>1/4 x 1</b>	10 x 1	Pan Combo	1/4"	100 Box
<b>12554</b>	Vinyl Tube Anchor-Green		<b>1/4 x 1</b>	10 x 1-1/4	Pan Combo	1/4"	100 Box
<b>12555</b>	Vinyl Tube Anchor-Green		<b>1/4 x 1-1/4</b>	10 x 1-1/4	Pan Combo	1/4"	100 Jar



# Assortments

## JIFFY FASTENER ASSORTMENTS

## IN REUSABLE PARTITIONED BOXES

Bar Code Number	Contains:	Size	Pieces/Box
<b>12588</b>	8 x 1/2 Jiffy Point Screws	<b>#475</b>	100
	8 x 3/4 Jiffy Point Screws		80
	8 x 1 Jiffy Point Screws		30
	8 x 2 Jiffy Point Screws		25
	8 x 3/4 Drilltip Screws		60
	1/4 x 1-3/4 Jiffy Chuck		1
	<b>12606</b>	7 x 1/2 Jiffy Point Screws	<b>#477</b>
8 x 1/2 Jiffy Point Screws			100
8 x 3/4 Jiffy Point Screws			100
10 x 1/2 (1/4) Head Jiffy Point Screws			100
10 x 3/4 (1/4) Head Jiffy Point Screws			100
<b>12608</b>		7 x 1/2 Jiffy Point Screws	<b>#479</b>
	8 x 1/2 Jiffy Point Screws		100
	8 x 3/4 Jiffy Point Screws		70
	10 x 1 (1/4 Head) Jiffy Point Screws		50
	10 x 1-1/2 (1/4 Head) Jiffy Point Screws		25
	1/4 x 1-3/4 Jiffy Chuck		1

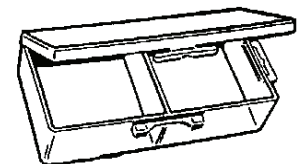

## MACHINE SCREW, NUT and LOCK WASHER ASSORTMENT

<b>12600</b>	Round Head Machine Screw	<b>6-32 x 1</b>	15
	Round Head Machine Screw	<b>6-32 x 1-1/2</b>	15
	Round Head Machine Screw	<b>6-32 x 2</b>	15
	Round Head Machine Screw	<b>8-32 x 1</b>	15
	Round Head Machine Screw	<b>8-32 x 1-1/2</b>	15
	Round Head Machine Screw	<b>8-32 x 2</b>	15
	Round Head Machine Screw	<b>10-32 x 1</b>	15
	Round Head Machine Screw	<b>10-32 x 1-1/2</b>	15
	Round Head Machine Screw	<b>10-32 x 2</b>	15
	Hex Nuts	<b>6-32, 8-32, 10-32</b>	50
	Lock Washers	<b>#6, #8, #10</b>	50

## BLUE MASONRY SCREW ASSORTMENT

Most Popular Hex Masonry or Phillips Flat Head Screws. Magnetic Chuck or Phillips Power Bit Included. Masonry Drill Bit Included

Bar Code Number	Item Description	Package Quantity
Bar Code	Items Included	Pcs. Ea.
<b>12601</b>	Hex Masonry Screw Assortment <b>#481</b> 1/4 x 1-3/4", 2-1/4", 2-3/4"	20
<b>12605</b>	Hex Masonry Screw <b>#483</b> 1/4 x 1-3/4	10
	Hex Masonry Screw 1/4 x 2-1/4	10
	Hex Masonry Screw 1/4 x 2-3/4	10
	Masonry Drill Bit 3/16 x 4	1
	Jiffy Chuck 5/16 x 1-3/4	1

## SOCKET SET SCREW ASSORTMENT

<b>29698</b>	Socket Set Screw Assortment	Socket Set Screw	10
	1/4-28 x 1/4, 3/8, 1/2, 5/16-18 x 1/4, 3/8, 1/2	(Contains 10 of ea. Size)	10

# Assortments

## JIFFY FASTENER ASSORTMENTS

### IN REUSABLE PARTITIONED BOXES

Bar Code Number	Contains:	Size	Pieces/Box
<b>12648</b>	<b>HEX NUT ASSORTMENT</b>		
		6-32	100
		8-32	100
		10-32	100
		1/4-20	50
		5/16-18	30
		3/8-16	20
<b>12660</b>	<b>FLAT WASHER ASSORTMENT</b>		
		#6	100
		#8	100
		#10	100
		1/4	75
		5/16	50
		3/8	35
		1/2	25
<b>12622</b>	<b>SELF DRILL SMS ASSORTMENT</b>		
		8X1/2 DRILTIP SCR	50
		8X3/4 DRILTIP SCR	50
		10X3/4 DRILTIP SCR	50
		10X1 DRILTIP SCR	50
		1/4 SHORT JIFFY CHUCK	1
		5/16 SHORT JIFFY CHUCK	

### DOUBLE END DRILL BITS

Bar Code Number	Item Description	Size	Package Quantity
<b>12700</b>	Double End Drill Bit	- 7/64" x 2"	12
<b>12702</b>	Double End Drill Bit	- 1/8" x 2"	12
<b>12703</b>	Double End Drill Bit	- 1/8" x 2"	144
<b>12704</b>	Double End Drill Bit	- 9/64" x 2"	12
<b>12706</b>	Double End Drill Bit	- 5/32" x 2-1/16"	12
<b>12708</b>	Double End Drill Bit	- 3/16" x 2-3/16"	12
<b>12712</b>	Double End Drill Bit	- 1/4 x 2-1/2"	12
<b>12714</b>	Double End Drill Bit	- #30 x 2"	12
<b>12715</b>	Double End Drill Bit	- #30 x 2"	144

### HIGH SPEED JOBBER SHEET METAL DRILL BITS 135° SPLIT

Bar Code Number	Item Description	Size	Package Quantity
<b>12726</b>	High Speed Jobber Drill Bit	- 1/16"	12
<b>12727</b>	High Speed Jobber Drill Bit	- 1/16"	3
<b>12728</b>	High Speed Jobber Drill Bit	- 5/64"	12
<b>12730</b>	High Speed Jobber Drill Bit	- 3/32"	12
<b>12732</b>	High Speed Jobber Drill Bit	- 7/64"	12
<b>12733</b>	High Speed Jobber Drill Bit	- 7/64"	3
<b>12734</b>	High Speed Jobber Drill Bit	- 1/8"	12
<b>12735</b>	High Speed Jobber Drill Bit	- 1/8"	3
<b>12737</b>	High Speed Jobber Drill Bit	- 9/64"	3
<b>12739</b>	High Speed Jobber Drill Bit	- 5/32"	2
<b>12741</b>	High Speed Jobber Drill Bit	- 11/64"	2
<b>12742</b>	High Speed Jobber Drill Bit	- 3/16"	12
<b>12743</b>	High Speed Jobber Drill Bit	- 3/16"	2
<b>12745</b>	High Speed Jobber Drill Bit	- 13/64"	1
<b>12747</b>	High Speed Jobber Drill Bit	- 7/32"	1

## Drill Bits



**HIGH SPEED JOBBER SHEET METAL DRILL BITS 135° SPLIT POINT**



12750	High Speed Jobber Drill Bit - 1/4"	6
12751	High Speed Jobber Drill Bit - 1/4"	1
12753	High Speed Jobber Drill Bit - 17/64"	1
12755	High Speed Jobber Drill Bit - 9/32"	1
12758	High Speed Jobber Drill Bit - 5/16"	6
12759	High Speed Jobber Drill Bit - 5/16"	1
12763	High Speed Jobber Drill Bit - 11/32"	1
12765	High Speed Jobber Drill Bit - 23/64"	1
12766	High Speed Jobber Drill Bit - 3/8"	6
12767	High Speed Jobber Drill Bit - 3/8"	1
12770	High Speed Jobber Drill Bit - 13/32"	1
12776	High Speed Jobber Drill Bit - 29/64"	1

**HIGH SPEED STEEL DRILL BITS with 1/4" SHANK**

Bar Code Number	Item Description	Size	Package Quantity
12790	High Speed Steel Drill Bit - 1/2		1 POS

**CARBIDE TIPPED MASONRY DRILL BITS**

Rotary / Percussion  
Professional Grade

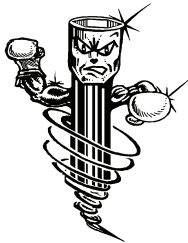

Bar Code Number	Item Description	Size	Package Quantity
14331	Carbide Tipped Masonry Drill Bit - 1/8 x 3	1/8	1 POS
12860	Carbide Tipped Masonry Drill Bit - 3/16 x 4	3/16	Bulk
12862	Carbide Tipped Masonry Drill Bit - 3/16 x 4	3/16	1 POS
12864	Carbide Tipped Masonry Drill Bit - 1/4 x 4	1/4	Bulk
12866	Carbide Tipped Masonry Drill Bit - 1/4 x 4	1/4	1 POS
12868	Carbide Tipped Masonry Drill Bit - 5/16 x 4	1/4	Bulk
12870	Carbide Tipped Masonry Drill Bit - 5/16 x 4	1/4	1 POS
12872	Carbide Tipped Masonry Drill Bit - 3/8 x 4	1/4	Bulk
12874	Carbide Tipped Masonry Drill Bit - 3/8 x 4	1/4	1 POS
12876	Carbide Tipped Masonry Drill Bit - 1/2 x 4	1/4	Bulk
12878	Carbide Tipped Masonry Drill Bit - 1/2 x 4	1/4	1 POS
12882	Carbide Tipped Masonry Drill Bit - 1/4 x 6	1/4	Bulk
14337	Carbide Tipped Masonry Drill Bit - 1/4 x 6	1/4	1 POS
14339	Carbide Tipped Masonry Drill Bit - 3/8 x 6	1/4	1 POS
14346	Carbide Tipped Masonry Drill Bit - 1/2 x 6	1/4	1 POS
14350	Carbide Tipped Masonry Drill Bit - 9/16 x 6	3/8	1 POS
12890	Carbide Tipped Masonry Drill Bit - 5/8 x 6	3/8	Bulk
14354	Carbide Tipped Masonry Drill Bit - 3/4 x 6	1/2	1 POS
14356	Carbide Tipped Masonry Drill Bit - 1 x 6	1/2	1 POS
14358	Carbide Tipped Masonry Drill Bit - 1/4 x 12	1/4	1 POS
14362	Carbide Tipped Masonry Drill Bit - 3/8 x 12	3/8	1 POS
14384	Carbide Tipped Masonry Drill Bit - 3/8 x 18	3/8	1 POS
14388	Carbide Tipped Masonry Drill Bit - 1/2 x 18	3/8	1 POS





**Jiffy Quick Change 1/4" Hex Power Shank Carbide Tipped Masonry Drill Bits Drill Bits**

Bar Code Number	Item Description	Size	Package Quantity
40570	Hex Shank Carbide Tip Masonry Drill Bit	1/4" x 5"	1 POS

**Jiffy Multi- Step Drills**

Self-Starting, Multiple Hole Sizes



Bar Code Number	Item Description	Size	Unibit #	No. of Holes	Hole Sizes	Incre-ments.	Package Quantity
16050	Jiffy Step Drill	1/4" Shank	1	13	1/8" to 1/2"	1/32"	1
16052	Jiffy Step Drill	1/4" Shank	2	6	3/16" to 1/2"	1/16"	1
16054	Jiffy Step Drill	3/8" Shank	3	9	1/4" to 3/4"	1/16"	1
16056	Jiffy Step Drill	3/8" Shank	4	12	3/16" to 7/8"	1/16"	1
16057	Jiffy Step Drill	1/2" Shank	5	10	1/4" to 1-3/8"	1/16"	1
16058	Jiffy Step Drill	1/4" Shank	10	N/A	1/2"		1
16060	Jiffy Step Drill	1/4" Shank	11	N/A	7/8"		1

**Jiffy Quick Change Multi- Step Drills**

1/4" Hex Power Shank

Bar Code	Description	Unibit #	# of Steps	Size Range	Pkg Qty
16062	Jiffy Quick Step Drill	1	13	1/8" to 1/2"	1
16064	Jiffy Quick Step Drill	2	6	3/16" to 1/2"	1

**Spade Wood Bits**

1/4" Shank

Bar Code Number	Item Description	Size	Package Quantity
14307	Spade Wood Drill Bit	- 1/2" x 6"	1 POS
14311	Spade Wood Drill Bit	- 5/8" x 6"	1 POS
14314	Spade Wood Drill Bit	- 3/4" x 6"	1 Bulk
14316	Spade Wood Drill Bit	- 7/8" x 6"	1 Bulk
14317	Spade Wood Drill Bit	- 7/8" x 6"	1 POS
14319	Spade Wood Drill Bit	- 15/16" x 6"	1 POS
14322	Spade Wood Drill Bit	- 1-1/8" x 6"	1 Bulk
14323	Spade Wood Drill Bit	- 1-1/8" x 6"	1 POS
14325	Spade Wood Drill Bit	- 1-1/4" x 6"	1 POS
14326	Spade Wood Drill Bit	- 1-3/8" x 6"	1 Bulk
14328	Spade Wood Drill Bit	- 1-1/2" x 6"	1 Bulk
14329	Spade Wood Drill Bit	- 1-1/2" x 6"	1 POS

**Jiffy Quick Change 1/4" Hex Drive Shank Spade Bits x 6" Long**

14617	Spade Wood Bit Hex Shank	- 3/4" x 6"	1 POS
14621	Spade Wood Bit Hex Shank	- 7/8" x 6"	1 POS
14624	Spade Wood Bit Hex Shank	- 1" x 6"	1 Bulk
14625	Spade Wood Bit Hex Shank	- 1" x 6"	1 POS
14627	Spade Wood Bit Hex Shank	- 1-1/8" x 6"	1 POS
14628	Spade Wood Bit Hex Shank	- 1-1/4" x 6"	1 Bulk
14629	Spade Wood Bit Hex Shank	- 1-1/4" x 6"	1 POS
14630	Spade Wood Bit Hex Shank	- 1-3/8" x 6"	1 Bulk
14631	Spade Wood Bit Hex Shank	- 1-3/8" x 6"	1 POS
14632	Spade Wood Bit Hex Shank	- 1-1/2" x 6"	1 Bulk
14633	Spade Wood Bit Hex Shank	- 1-1/2" x 6"	1 POS

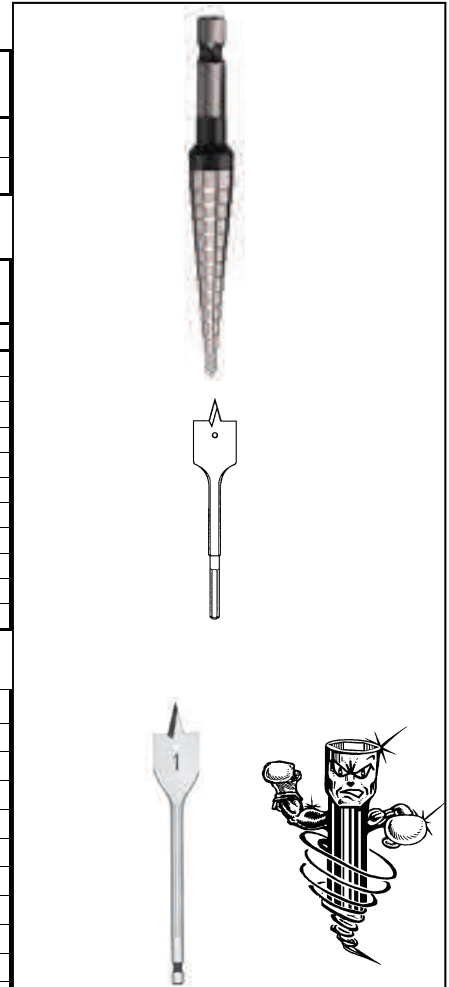

# Bell Hanger Bits— For Thermostat Wire Installation

## Stiff Shaft for Wood



40628	Bell Hanger Bit— 1/4" x 12"	1
40630	Bell Hanger Bit— 1/4" x 18"	1
40632	Bell Hanger Bit— 1/4" x 24"	1
40634	Bell Hanger Bit— 1/4" x 36"	1

## Stiff Shaft for Masonry



40794	Bell Hanger Bit— Stiff Shaft for Masonry—	1/4" x 18"	1
40798	Bell Hanger Bit— Stiff Shaft for Masonry—	3/8" x 18"	1

## Jiffy Quick Change 1/4" Hex Power Shank High Speed Drill Bits

1/4" Hex Shank— No Slipping  
Titanium-Nitride Coated

Use With Jiffy Quick Change Adapter

Bar Code Number	Item Description	Length	Package Quantity
40416	1/8" Hex Shank Drill Bit	2-3/4"	1 Bulk
40417	9/64" Hex Shank Drill Bit	2-7/8"	1 Bulk
40428	3/16" Hex Shank Drill Bit	3-1/8"	1 Bulk
40440	1/4" Hex Shank Drill Bit	3-5/8"	1 Bulk



## Jiffy Quick Change Drill Router

1/4" Hex Power Shank— No Slipping  
Use with Wood, Plastic, Metal

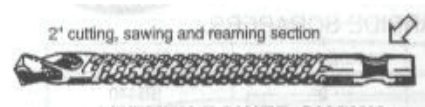

Bar Code Number	Item Description	Length	Package Quantity
10597	Jiffy Quick Change Drill Router		1 Bulk

## SDS Hammer Drill Bits

For drilling in concrete, brick, stone, and other masonry materials.  
Double spiral flute clears dust quickly & reduces friction.  
Made to ANSI standards.

**ROTARY  
PERCUSSION  
PROFESSIONAL  
GRADE**

Bar Code Number	Item Description	Size	Length	Package Quantity
14403	SDS Hammer Drill Bit	3/16"	4"	Pkg.
14407	SDS Hammer Drill Bit	3/16"	8"	Pkg.
14415	SDS Hammer Drill Bit	1/4"	4"	Pkg.
14448	SDS Hammer Drill Bit	1/2"	10"	Bulk

Please call for price on any sizes not listed.

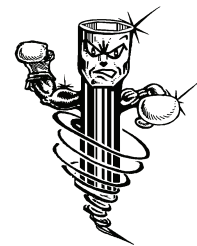

# Hex Cap Screws

Zinc Plated Low Carbon Steel  
 Proof Load: 55,000 PSI Minimum Tensile Strength: 74,000 PSI  
 Meets or exceeds ANSI/ASME B18.2.1, SAE J429, SAE J1061 and ASTM 788 Standards  
 Use with finished hex nut

## Grade 2

E Cap Screw Diameter (In.)	F Width(In.) of Hex Head	H Height (In.)	LT Thread Length (In.)
1/4	7/16	5/32	0.750
5/16	1/2	13.64	0.875
3/8	9/16	15/64	1.000
7/16	5/8	9/32	1.125
1/2	3/4	5/16	1.250
9/16	13/16	23/64	1.375
5/8	15/16	25/64	1.500
3/4	1-1/8	15/32	1.750

Bar Code Number	Size	Pkg. Qty.
22234	3/8-16 x 1"	100
22240	3/8-16 x 1-1/4"	100
22246	3/8-16 x 1-1/2"	100
22396	1/2-13 x 1-1/2"	50
22480	5/8-11 x 1"	25
22482	5/8-11 x 1-1/4"	25
22484	5/8-11 x 1-1/2"	25
22488	5/8-11 x 2"	25
22526	3/4-10 x 1-1/2"	20
22528	3/4-10 x 2"	20

## CARRIAGE BOLTS

Bar Code Number	Size	Pkg. Qty.
23236	3/8-16 x 1"	1000 Jiffy Pail
23238	3/8-16 x 1"	500 Box
23240	3/8-16 x 1"	250 PL Bucket
23242	3/8-16 x 1"	100 Box

## HEX TAP BOLTS

Coarse Thread  
Zinc Plated Grade 2

Bar Code Number	Size	Pkg. Qty.
22570	1/4-20 x 1"	100 Box
22571	Circulator Pack- 4- 3/8" x 2" w/ Nuts	8 Hang Pack

## J-Bolts

Zinc Plated

21525	3/8" x 3-1/4" w/ Nut	10 Box
-------	----------------------	--------

## Lag Screws

Zinc Plated  
Low Carbon Steel  
Hex Head

1/4" Diameter

Use 7/16" Jiffy Chuck  
for Easy Installation

Bar Code Number	Size	Pkg. Qty.
24046	1/4-10 x 2"	100 Box
24070	1/4-10 x 3"	100 Box

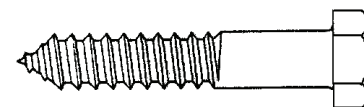
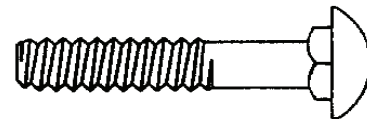
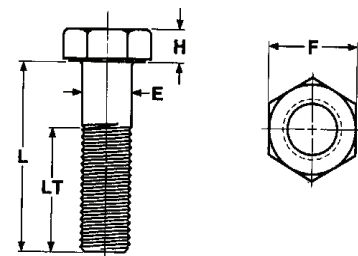

Call for Availability and Pricing of Hex  
Cap Screws, Cap Bolts, Carriage Bolts  
& Lag Screws Not Listed

**Vertigo**

Rod Hanger Fastening System

Vertigo Fasteners sold in full box qty. only.  
Call for complete engineering data

Bar Code	Vertigo Part No.	Cross Ref Part No.	Rod Size	Screw Shank Size & Length	Qty/Box
<b>STEEL VERTICAL HANGER</b>					
47155	7155	DSTR100	1/4"	1/4-20x1"	100
47157	7157	DSTR1	3/8"	1/4-20X2"	100
47158	7158	DSTR1	3/8"	1/4-20x1" W/NUTS	100
47159	7159	DST15	3/8"	1/4-20X1-1/2"	100
47160	7160		3/8"	1/4-20X1-1/2" W/NUTS	100
47152	7152		1/4"	12-24X1-1/2"	100
47154	7154		3/8"	12-24X1-1/2" W/NUTS	100
47161	7161	TEK50	1/2"	12-24X1-1/2" W/NUTS	100
<b>WOOD VERTICAL HANGER</b>					
47163	7163	GST100	1/4"	1/4"X1"	100
47203	7203	GST10	3/8"	1/4"X1"	100
47165	7165	GST20	3/8"	1/4"X2"	100
47167	7167	GST30	3/8"	1/4"X3"	100
47169	7169	GST40	3/8"	1/4"X4"	100
47162	7162		3/8"	3/8"X2-1/2"	100
47164	7164		1/2"	3/8"X2-1/2"	100
<b>CONCRETE VERTICAL HANGER</b>					
47171	7171	CST200	1/4"	1/4"X1-1/4"	100
47173	7173	CST20	3/8"	1/4"X1-1/2"	100
47175	7175	CST2	1/2"	3/8"X2-3/4"	50
<b>STEEL SIDE HANGER</b>					
47183	7183	JRC1-1/2	1/4"	1/4-20X1"	100
47100	7200		1/4"	12-24X1-1/2"	100
47101	7201		3/8"	12-24X1-1/2" W/NUTS	100
47184	7184	SWD10	3/8"	1/4-20X1" W/NUTS	100
47186	7186		3/8"	1/4-20X1-1/2" W/NUTS	100
47188	7188	SWDR1	3/8"	1/4-20X2" W/NUTS	100
<b>WOOD SIDE HANGER</b>					
47185	7185	SWG200	1/4"	1/4"X1"	100
47170	7170	SWG20	3/8"	1/4"X2"	100
47156	7156		3/8"	1/4"X2-1/2"	100
47105	7205	SWG10	3/8"	1/4"X1"	100
<b>ACCESSORIES</b>					
47195	7195			1/4" CONCRETE SOCKET	1
47197	7197			3/8" CONCRETE SOCKET	1
47198	7198			1/2" CONCRETE SOCKET	1
80038				3/8" to 1/2" Threaded Rod Adapter	25
47187		JIFFY UNIVERSAL DRIVER			1



**ROD HANGER CROSS REFERENCE**

Bar Code	Description	Rod Size	Vertigo No.	Hangermate No.	Sammy No.
<b>STEEL VERTICAL HANGER</b>					
47155	1/4-20x1"	1/4"	7155	EZG160	DST100
47157	1/4-20x2"	3/8"	7157	EZG450	
47158	1/4-20x1" W/NUTS	3/8"	7158	EZG471	
47159	1/4-20x1-1/2"	3/8"	7159	EZG490	
47160	1/4-20x1-1/2" W/NUTS	3/8"	7160	EZG491	
47152	12-20x1-1/2"	1/4"	7152		
47154	12-20x1-1/2" W/NUTS	3/8"	7154		
47161	12-20x1-1/2" W/NUTS	1/2"	7161		
<b>WOOD VERTICAL HANGER</b>					
47163	1/4"x2"	1/4"	7163		
47203	1/4"x1"	3/8"	7203		
47165	1/4"x2"	3/8"	7165		
47167	1/4"x3"	3/8"	7167	EZG670	
47169	1/4"x4"	3/8"	7169		
47162	3/8"x2-1/2"	3/8"	7162		
47164	3/8"x2-1/2"	1/2"	7164		
<b>CONCRETE VERTICAL HANGER</b>					
47171	1/4"x1-1/4"	1/4"	7171		
47173	1/4"x1-1/2"	3/8"	7173		
47175	3/8"x2-3/4"	1/2"	7175		
<b>STEEL SIDE HANGER</b>					
47183	1/4"x20-1"	1/4"	7183	EZH155	SWDR100
47100	12-20x1-1/2"	1/4"	7200		
47101	12-20x1-1/2" W/NUTS	3/8"	7201		
47184	1/4-20x1" W/NUTS	3/8"	7184	EZH476	
47186	1/4-20x1-1/2" W/NUTS	3/8"	7186	EZH496	
47188	1/4-20x2" W/NUTS	3/8"	7188		
<b>WOOD SIDE HANGER</b>					
47185	1/4"x1"	1/4"	7185		
47170	1/4"x2"	3/8"	7170		
47156	1/4"x2-1/2"	3/8"	7156		
47105	1/4"x1"	3/8"	7205		
<b>ACCESSORIES</b>					
47195	1/4" CONCRETE SOCKET		7195		
47197	3/8" CONCRETE SOCKET		7197		
47198	1/2" CONCRETE SOCKET		7198		
80038	3/8 THREADED ROD ADAPTER				
47187	JIFFY UNIVERSAL DRIVER				

# HangerMate®

## THREADED ROD ANCHORING SYSTEM



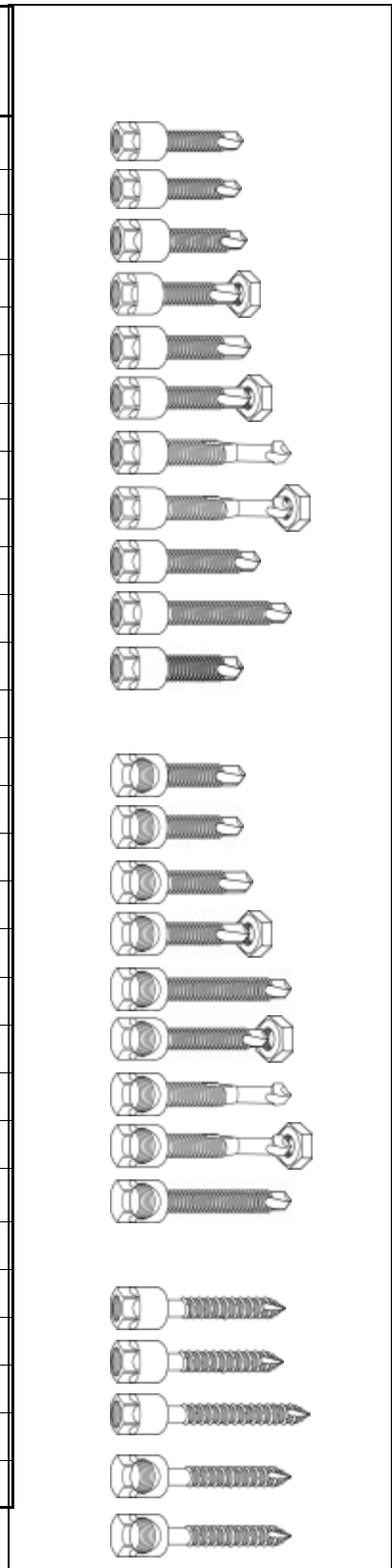









Bar Code	Stock No.	Item Description	Rod Size	Steel Thick.	Qty/Box
<b>Steel Applications— Vertical Mount—End Drilled Head</b>					
80000	EZG160	1/4-20 x 1 #3 Point	1/4-20	.060-.250	50
<b>80001</b>	<b>EZG450</b>	<b>1/4-20 x 1 # 2 Point</b>	<b>3/8-16</b>	<b>.060-.125</b>	<b>50</b>
80002	EZG470	1/4-20 x 1 #3 Point	3/8-16	.060-.250	50
<b>80003</b>	<b>EZG471</b>	<b>1/4-20 x 1 #3 Point w/ Nuts</b>	<b>3/8-16</b>	<b>.060-.250</b>	<b>50</b>
80004	EZG490	1/4-20 x 1-1/2 #3 Point	3/8-16	.060-.250	50
80005	EZG491	1/4-20 x 1-1/2 #3 Point w/ nuts	3/8-16	.060-.250	50
80006	EZG510	1/4-20 x 1-1/2 #5 Point	3/8-16	.187-.500	50
80007	EZG511	1/4-20 x 1-1/2 #5 Point w/nuts	3/8-16	.060-.500	50
80008	EZG530	1/4-20 x 2 #3 Point	3/8-16	.060-.250	50
80009	EZG540	1/4-20 x 3 #3 Point	3/8-16	.060-.250	50
80010	EZG550	Discontinued— Use EZG 470			50
<b>Horizontal Mount—Cross Drilled Head</b>					
80011	EZH155	1/4-20 x 1 # 3 Point	1/4-20	.060-.250	50
<b>80012</b>	<b>EZH455</b>	<b>1/4-20 x 1 #2 Point</b>	<b>3/8-16</b>	<b>.060-.125</b>	<b>50</b>
<b>80013</b>	<b>EZH475</b>	<b>1/4-20 x 1 #3 Point</b>	<b>3/8-16</b>	<b>.060-.250</b>	<b>50</b>
80014	EZH476	1/4-20 x 1 #3 Point w/ Nuts	3/8-16	.060-.250	50
<b>80015</b>	<b>EZH495</b>	<b>1/4-20 x 1-1/2 #3 Point</b>	<b>3/8-16</b>	<b>.060-.250</b>	<b>50</b>
80016	EZH496	1/4-20 x 1-1/2 #3 Point w/ nuts	3/8-16	.060-.250	50
80017	EZH515	1/4-20 x 1-1/2 #5 Point	3/8-16	.187-.500	50
80018	EZH516	1/4-20 x 1-1/2 #5 Point w/ nuts	3/8-16	.060-.500	50
80019	EZH535	1/4-20 x 2 #3 Point	3/8-16	.060-.250	50
<b>Wood Applications— Vertical Mount - End Drilled Head</b>					
80020	EZG315	5/16 x 2-1/4	1/4-20		50
<b>80021</b>	<b>EZG650</b>	<b>5/16 x 2-1/4</b>	<b>3/8-16</b>		<b>50</b>
<b>80022</b>	<b>EZG670</b>	<b>5/16 x 3</b>	<b>3/8-16</b>		<b>50</b>
<b>Horizontal Mount—Cross Drilled Head</b>					
80023	EZH320	5/16 x 2-1/4	1/4-20		50
<b>80024</b>	<b>EZH665</b>	<b>5-16 x 2-1/4</b>	<b>3/8-16</b>		<b>50</b>



NOTE: ITEMS IN BOLD ARE STOCK.  
OTHERS MAY REQUIRE MINIMUM ORDER

# HangerMate®

## THREADED ROD ANCHORING SYSTEM (Continued.....)

Bar Code Number	Stock No.	Item Description	Rod Size	Steel Thick.	Qty/Box	
<b>Concrete Applications- Vertical Mount—End Drilled Head</b>						
80025	EZG365	5-16 x 2-1/4	1/4-20		50	
<b>80026</b>	<b>EZG730</b>	<b>5/16 x 2-1/4</b>	<b>3/8-16</b>		<b>50</b>	
<b>Horizontal Mount—Cross Drilled Head</b>						
80027	EZH370	5/16 x 2-1/4	1/4-20		50	
80028	EZH735	5/16 x 2-1/4	3/8-16		50	
<b>New! Universal Anchors for Wood, Metal, Or Concrete</b>						
<b>80037</b>	<b>EZG910</b>	<b>1/4 X 2 End Drilled</b>	<b>1/4-20</b>		<b>50</b>	
<b>80035</b>	<b>EZG 930</b>	<b>1/4 X 2 End Drilled</b>	<b>3/8-16</b>		<b>50</b>	
<b>80036</b>	<b>EZH935</b>	<b>1/4 X 2 Cross Drilled</b>	<b>3/8-16</b>		<b>50</b>	
<b>Accessories</b>						
<b>80038</b>		<b>3/8" to 1/2" Threaded Rod Adapter</b>			<b>25</b>	
<b>Installation Tools</b>						
<b>80030</b>	<b>EZE220</b>	Drive Sleeve			1	
<b>80031</b>	<b>EZE240</b>	Drill Bit Adaptor Kit			1	
<b>80032</b>	<b>EZE340</b>	ANSI 1/4" Tanged Drill Bit for Hammer Drills			1	
<b>80033</b>	<b>EZE350</b>	ANSI 1/4" SDS Drill Bit for Rotary Hammer Drills			1	
<b>80029</b>		JIFFY UNIVERSAL DRIVER			1	

NOTE: ITEMS IN BOLD ARE STOCK.  
OTHER ITEMS MAY REQUIRE MINIMUM ORDER.

# Section 3

## HVACR HARDWARE AND ACCESSORIES

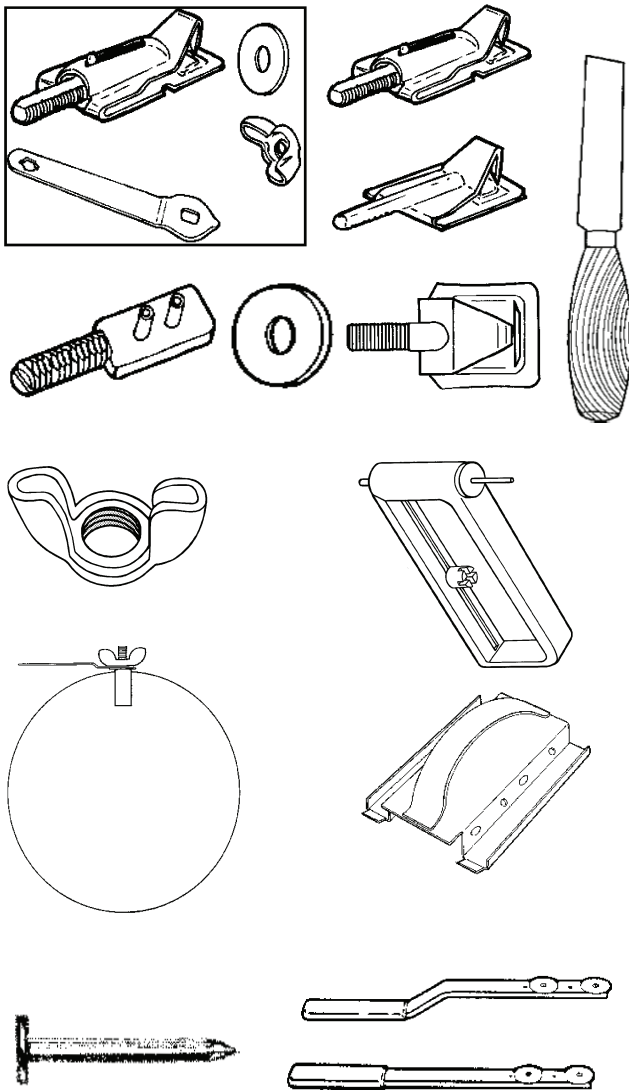

Warm Air Dampers  
Hammer On Damper Hardware  
Regulator Sets & Accessories  
Damper Regulator Dials  
Blued Panning Nails  
Amcraft Fiberglass Duct Tools  
"Jiffy" HVACR Specialty Tools

Shook carries a full line of items to meet your HVAC&R needs.

We also stock many special tools to help make your job easier and more productive. When it comes to tools, think SHOOK as your supply source.

Shook provides its own line of quality tools that you just don't find every day. **Shook "Jiffy" Tools** provide quality at outstanding prices.



# “Jiffy Quick” Hammer-on Damper Hardware

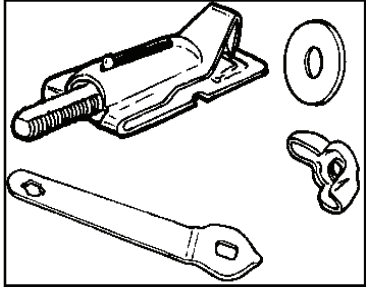

Bar Code Number	Item Description	Packaging Quantity
00004	Single Regulator Set	12 Sets / Box
Includes:	50010 5/16" Spring Bearing	
	50011 Washer	
	50012 Handle	
	50013 Wing Nut	
00005	Double Regulator Set	12 Sets / Box
Includes:	50010 5/16" Spring Bearing	
	50011 Washer	
	50012 Handle	
	50013 Wing Nut	

## Damper Accessories

<b>00010</b>	5/16" Spring Loaded Damper Bearing	1000
<b>00014</b>	Plain Damper Tip	1000

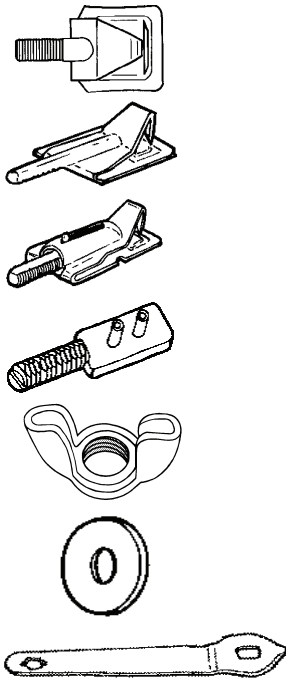

Bar Code Number	Item Description	Packaging Quantity
<b>00054</b>	Damper Handle	100
<b>12436</b>	1/4" ID Washer	100
<b>12438</b>	5/16" ID Washer	100
<b>12422</b>	1/4" Stamped Wing Nut	100
<b>12424</b>	5/16" Stamped Wing Nut	100
<b>12491</b>	5/16" Stamped Wing Nut	1000

# “Jiffy Quick” Warm Air Dampers

## 1/4” Bearing

Heavy Galvanized Steel  
Adjust with Screwdriver or Attached Handle

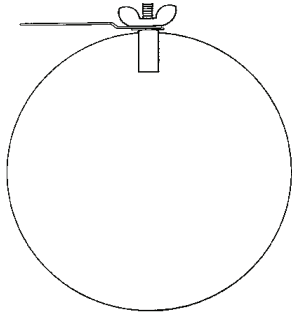

SINGLE



DOUBLE

Bar Code Number	Item Description	Packaging Quantity
<b>00020</b>	<b>4” Damper</b> Single Bearing with Attached Handle	100
<b>00024</b>	<b>5” Damper</b> Single Bearing with Attached Handle	100
<b>00026</b>	<b>5” Damper</b> Single Bearing with Wing Nut	100
<b>00028</b>	<b>6” Damper</b> - Single Bearing with Attached Handle	100
<b>00030</b>	<b>6” Damper</b> Single Bearing with Wing Nut	100
<b>00032</b>	<b>6” Damper</b> - Double Bearing with Attached Handle	100
<b>00034</b>	<b>6” Damper</b> - Double Bearing with Wing Nut	100
00314	<b>6” Damper</b> - Double Bearing with Attached Handle	12
<b>00036</b>	<b>7” Damper</b> Single Bearing with Attached Handle	100
00038	<b>7” Damper</b> - Double Bearing with Attached Handle	100
<b>00040</b>	<b>7” Damper</b> - Double Bearing with Wing Nut	100
<b>00042</b>	<b>8” Damper</b> - Single Bearing with Attached Handle	100
00044	<b>8” Damper</b> - Double Bearing with Attached Handle	100
<b>00046</b>	<b>8” Damper</b> - Double Bearing with Wing Nut	100
00334	<b>8” Damper</b> - Double Bearing with Attached Handle	12
00049	<b>10” Damper</b> - Double Bearing with Attached Handle	50
00360	<b>10” Damper</b> - Double Bearing with Attached Handle	12
00051	<b>12” Damper</b> - Double Bearing with Attached Handle	50
00364	<b>12” Damper</b> - Double Bearing with Attached Handle	12
00053	<b>14” Damper</b> - Double Bearing with Attached Handle	50

## 5/16” Spring Loaded Bearing

Heavy Galvanized Steel  
Adjust with Screwdriver or Attached Handle

Bar Code Number	Item Description	Packaging Quantity
00458	<b>7” Damper</b> - Double Bearing with Attached Handle	100
00464	<b>8” Damper</b> - Double Bearing with Attached Handle	100
00470	<b>9” Damper</b> - Double Bearing with Attached Handle	50
00476	<b>10” Damper</b> - Double Bearing with Attached Handle	50
00482	<b>12” Damper</b> - Double Bearing with Attached Handle	50
00490	<b>14” Damper</b> - Double Bearing with Attached Handle	1
00494	<b>16” Damper</b> - Double Bearing with Attached Handle	1
00498	<b>18” Damper</b> - Double Bearing with Attached Handle	1

**Note: Bold Bar Coded Items compare to other manufacturers' stock items**

# AMCRAFT INC. *Fiberglass Duct Tools*

Bar Code Number	Item Description	Amcraft No.	Packaging Quantity
40060	Round Hole Cutter- 3-20"	5001	1
40062	4" Duct Knife	8000	1
40066	90 V or Miter Cut Tool – Red	1100	1
40072	4-in-1 End Cut Tool - Blue	1102	1

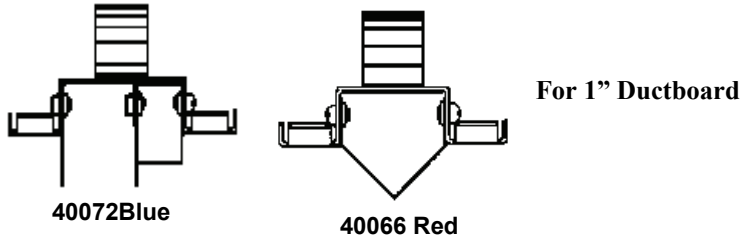
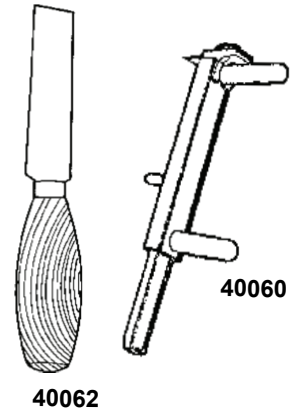

## "Jiffy" HVACR Specialty Tools

### Fiberglass Duct Tools

Bar Code Number	Item Description	Qty & Pkg
40081	Bostitch Model PC-4000 OC2 Out Clinch Stapler	1
40082	1/2" Staples	4M Box
40083	9/16" Staples	4M Box



### Sheet Metal Hole Cutter

40014	Sheet Metal Hole Cutter – 12" Dia. Capacity	1
40000	Cutter Bit for Hole Cutter	1
40015	Pivot Pin for Hole Cutter	1

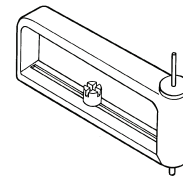

### Sheet Metal Folding Tools

Make 1" Flanges for fitting plenums, joist panning, register boots and trunk line end caps.

Use the 3/8" depth to create folds for C-drives.

Steel seam halves are permanently joined.

Folds 24 gauge galvanized sheet metal easily.

13824	8" Folding Tool - 3/8" and 1/2" Seams No. 650	1 POS
13826	12" Folding Tool - 3/8" and 1/2" Seams No. 652	1 POS
40040	12" Folding Tool - 3/8" and 1" Seams	1 POS
40042	18" Folding Tool - 3/8" and 1" Seams	1 POS
40043	24" Folding Tool - 3/8" and 1" Seams	1 POS

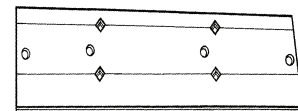

# “Jiffy” HVACR Specialty Tools ... Continued

## Duct Stretchers

Bar Code Number	Item Description	Packaging Quantity
40008	Duct Stretcher – Straight	1
40010	Duct Stretcher – Offset	1

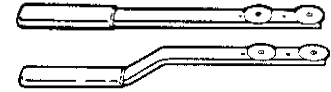

## Blued Panning Nails

Bar Code Number	Item Description	Prod. No.	Packaging Quantity
00077	Panning Nails	BPN2	2 lb Box
00076	Panning Nails	BPN3	3 lb Box
00078	Panning Nails	BPN5	5 lb Box
00075	Panning Nails	BPN	50 lb Box



## Awls

13839	4" Awl– Wood Handle	No. TZ8410	1 Bulk
13836	5-1/2" Awl - Cellulose acetate plastic handle	No. 902	1 Bulk
13838	5-1/2" Awl - Cellulose acetate plastic handle	No. 902C	Carded
13840	6-1/2" Awl - Professional quality -Bulk	No. 904	1 Bulk
13842	6-1/2" Awl - Professional quality	No. 904C	Carded

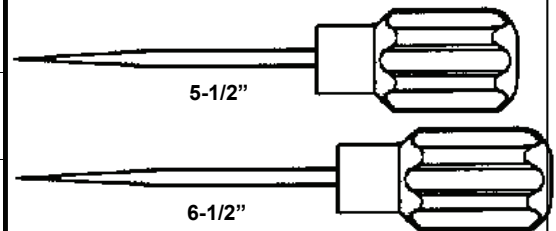



# Section 44



Take the **Shook Advantage** when purchasing Tools!

Shook carries a full line of...

Fairmont Metal Tongs

Kett Power Tools

Saw Blades & Hole Saws

Shook "**Jiffy**" Tools

**SHOOK "Jiffy" TOOLS**

## FAIRMONT TONGS

We also stock many other hand tools to help make your job easier and more productive. When it comes to tools, think SHOOK as your supply source.

Shook provides its own line of quality tools that you just don't find every day. **Shook Jiffy Tools** provide quality and durability with outstanding prices.



# SHOOK "JIFFY" TOOLS

## Utility Knives & Blades

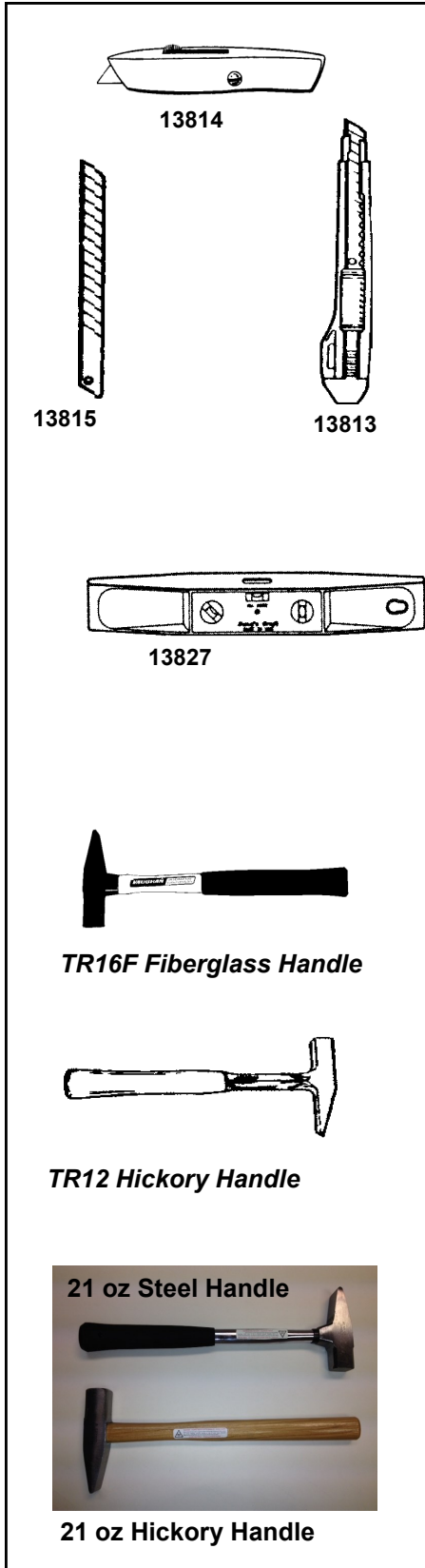

<b>13814</b>	3" Utility Knife No. 627	1 Bulk
<b>13813</b>	13 Point Snap Blade Knife	1 POS
<b>13815</b>	10 PK Blades for 13 Point Snap Blade Knife	1 POS
<b>13817</b>	7 Point Snap Blade Knife	1 POS
<b>13818</b>	100 PK Blades for 6" Utility Knife	1
<b>13819</b>	10 PK Blades for 8 Point Snap Blade Knife	1 POS
<b>12820</b>	5 PK Blades for 6" Utility Knife	1

## Levels

Bar Code Number	Item Description		Qty. Pkg.
<b>13830</b>	9" Magnetic Torpedo Level	No. 711	1 POS

# Jiffy Tinner's Hammers

Striking tool heads are forged from American-made, high carbon steel  
 Tool heads are heat-treated and precision machined  
 Polished steel finish  
 Octagon Head-Flat striking face- Rounded Cross Pein

<b>19300</b>	Tinner's Riveting Hammer 168-10	<b>TR16F</b>	16 oz.	12-1/2"
<b>19301</b>	"Jiffy" Tinner's Riveting Hammer Fiberglass Handle	21FG	21 oz.	14-1/4"
<b>19302</b>	Tinner's Riveting Hammer 168-15	<b>TR12</b>	12 oz.	12-1/2"
<b>19303</b>	"Jiffy" Tinner's Riveting Hammer Hickory Handle	21HWD	21 oz.	14-1/4"
<b>19305</b>	"Jiffy" Tinner's Riveting Hammer Steel Handle		21 oz.	14-1/4"



# "JIFFY" SHEET METAL SNIPS

Superb Tradesman Quality at Competitive Prices

**All product sleeved for hanging and display**

- 13960** Left Cut, Red Handle
- 13964** Right Cut, Green Handle
- 13968** Straight Cut, Yellow Handle
- 13961** Offset, Left Cut, Right Hand, Red Handle
- 13963** Offset, Right Cut, Left Hand, Green Handle
- 13965** Long Cut
- 13967** Bulldog
- 13958** Offset Left Vertical
- 13959** Offset Right Vertical

- Meets ANSI & DIN standards
- Comfortable cushion grip
- High tensile strength pivot fastener
- Exclusive 2-tone, soft to the touch, slip resistant grips
- Drop forged chrome Molybdenum alloy steel blades hardened to 60-62



Left Cut—#13960



Straight—#13968



Right Cut—#13964



Long Cut—#13965



Offset Left Cut—#13961



Bulldog—#13967



Offset Left Vertical—#13958



Offset Right Cut—#13963



Offset Right Vertical—#13959

### CROSS REFERENCE

SHOOK JIFFY SNIP	MALCO AV	MIDWEST	KLENK	WISS / COOPER
13960	AV1 53029	P6716-L	KJS1 MA7000	M1R
13964	AV2 53030	P6716-R	KJS2 MA70010	M2R
13968	AV3 53031	P6716-S	KJS3 MA70020	M3R
13961	AV6 53032	P6510-L	KOS1 MA75200	M6R
13963	AV7 53033	P6510-R	KOS2 MA75210	M7R
13967	N/A	P6716-B	KBD M5R NA	M5R
13958				
13959				

## Sheet Metal Tools

<b>13976</b>	Sheet Metal Crimper		1
<b>13994</b>	Hand Seamer, 3" Capacity	8-1/4"	1



## Fairmont Sheet Metal Tong

Bar Code	Item Description	Fairmont Part #	Qty. Pkg.
<b>43000</b>	Fairmont Tong	<b>MT14000</b>	1
<b>43002</b>	Offset Fairmont Tong	<b>MT14010</b>	1
<b>43004</b>	Fairmont Tong with Cushion Grip	<b>MT14020</b>	1
<b>43006</b>	Offset Fairmont Tong with Cushion Grip	<b>MT14030</b>	1

### SHEET METAL TONGS

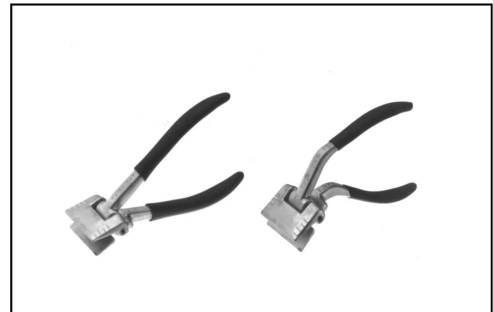

\*\*\*See Page 67 for Jiffy Aviation Snips



# Shook "Jiffy" Swivel Head Shear

Swivel Head Sheet Metal Shear  
 4.0 Amp- Variable Speed- 0-2500 RPM  
 Aluminum Cutting Head Swivels 360 degrees

High Speed Steel Cutting Blades  
 Capacity to 14 Gauge Sheet Metal, 16 GA Stainless Steel  
 1 Year Warranty

Bar Code	Description
13903	Swivel Head Sheet Metal Shear & Case
13905	Right Blade
13907	Left Blade
13909	Center Blade
13911	Blade Kit- Includes Right, Left & Center



## POWER SHEARS

Bar Code	Description	Kett #	Head	Length
13900	Electric 18 GA. Portable Power Shears, Variable Speed	KD-400	60-20	13-1/2"
13902	KD-400, Variable Speed with Steel Carrying Case	Kit#100	60-20	13-1/2"
13929	KD-400, Variable Speed with Plastic Carrying Case		60-20	13-1/2"
13956	KD-400, Variable Speed, Nibbler Attachment and Steel Case	Kit#210	60-20	13-1/2"
13936	Electric 14 GA. Power Shears	KD-440	40-20	14"
13938	KE-440 with Steel Carrying Case	Kit#340	40-20	14"
33912	Electric Variable Speed 16GA Shear	KD-442		
33926	Heavy Duty Electric 14 GA. Scissor Shears	KD-441		
13954	Nibbler Attachment for above Kett Shears		1020	
33944	Steel Carrying Case	251-4		



KD-400



KIT 100



NIBBLER

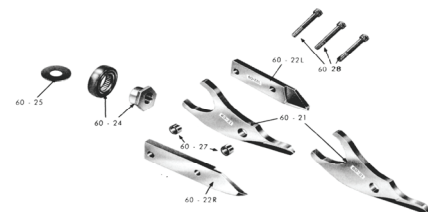

### SHEAR BLADES

13912	Center Blade for KD-200	1
13914*	Left Side Knife for all 14, 16, 18 GA Shears	1
13916*	Right Side Knife for all 14, 16, 18 GA Shears	1

### SHEAR BLADE KITS

Bar Code	Description	Kett Part #
13904	Heavy User Blade Kit for KD-400	Kit #101
13906	Intermediate Blade Kit for KD-400	Kit #102

### "Jiffy" Tools - Hex Key Sets

#### Metal Hex Key Fold-Up Sets - Standard Sets

Heat Treated, 8650 Chrome Nickel Alloy Steel  
 Meet ANSI B18-3 and Fed. Spec. GGG-K-275D as applicable  
 Hex steel tolerance of plus 0.000/minus 0.001

Bar Code	Description	Component Keys	Pkg. Qty.
16204	Medium Set - 9 Sizes, .050", 1/16", 5/64", 3/32", 7/64", 1/8", 9/64", 5/32", 3/16"		1 POS

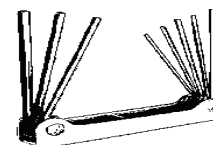

# Reciprocating Saw Blades

Matrix II Cutting Edge  
 Tooth Hardness RC 65-67  
 8% Cobalt  
 Vacuum Heat Treated with Special Temper Process  
 Shock Resistant Teeth that Resist Stripping for Long Life

Accepts More Feed Pressure for Faster Cutting and  
 Less Distortion  
 3/4" Width .035" and .050" Thickness  
 (Thicker and Wider than Some Competitors' Blades.- Greater Rigidity)

## Bi-Metal Rough-In Wood and Nail - 1/2" Shank Blades

6 teeth per inch rough-in blades are perfect for...  
 Wood cutting  
 Composition materials  
 Cutting through embedded nails in wood

10/14 teeth per inch rough-in blades are perfect for...  
 Wood cutting  
 Composition materials  
 Plastics  
 Thin metals

Bar Code Number	Item Description Part Number	No. Teeth Per Inch	Blade Size (Length X Width X Thickness)	Pkg. Qty.
18000	Wood and Nail - <b>RB606STT05</b>	6	6" x 3/4" x .035"	5 Per Tube
18008	Wood and Nail - <b>RB65006T05</b>	6	6" x 3/4" x .050"	5 Per Tube
18010	Wood and Nail - <b>RB95006T05</b>	6	9" x 3/4" x .050"	5 Per Tube
18012	Wood and Nail - <b>RB125006T05</b>	6	12" x 3/4" x .050"	5 Per Tube
18044	Wood and Nail - <b>RB610T05</b>	10	6" x 3/4" x .035"	5/Tube
18050	Wood and Nail - <b>RB6501014T05</b>	10/14	6" x 3/4" x .050"	5/Tube
18052	Wood and Nail - <b>RB81014T05</b>	10/14	8" x 3/4" x .050"	5/Tube
18078	Wood and Nail - <b>RB12501014T05</b>	10/14	12" x 3/4" x .050"	5/Tube



## Bi-Metal Metal Cutting - 1/2" Shank Blades

14 - 18 Teeth Per Inch Blades are Perfect For...  
 Heavy Gauge Metals 1/8" Thick and up  
 Cutting Bar Stock and Angle Iron  
 Cutting Thick Conduit, Pipe and Tubing

18086	Heavy Duty Metal - <b>RB614T05</b>	14	6" x 3/4" x .035"	5 Per Tube
18088	Heavy Duty Metal - <b>RB1214T05</b>	14	12" x 3/4" x .035"	5 Per Tube
18090	Heavy Duty Metal - <b>RB814P</b>	14	8" x 3/4" x .035"	5/Tube
18092	Heavy Duty Metal - <b>RB418P</b>	18	4" x 3/4" x .035"	5/Tube
18094	Heavy Duty Metal - <b>RB618T05</b>	18	6" x 3/4" x .035"	5 Per Tube
18096	Heavy Duty Metal - <b>RB1218T05</b>	18	12" x 3/4" x .035"	5 Per Tube
18098	Heavy Duty Metal - <b>RB818T05</b>	18	8" x 3/4" x .035"	5 Per Tube
18100	Heavy Duty Metal - <b>RB424T05</b>	24	4" x 3/4" x .035"	5/Tube
18102	Heavy Duty Metal - <b>RB624T05</b>	24	6" x 3/4" x .035"	5 Per Tube
18284	Heavy Duty Metal— <b>RB65018T05</b>	18	6" x .050"	5/Tube





# REMS SPEZIAL

Here is your chance to try a recognized German product accepted worldwide

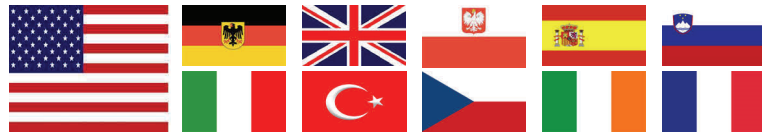

Suitable for all threading and sawing applications

- Steel, stainless, non-ferrous metals, and plastic
- High alloyed
- Mineral based
- CFC & ozone friendly
- Water clean-up
- Large 21.2 ounce spray can

SEE PAGE 77 FOR INFORMATION ON OTHER REMS PRODUCTS

# Section 5

## ELECTRICAL COMPONENTS & ACCESSORIES

Take the ***Shook Advantage*** when purchasing Electric Components and Accessories!

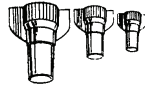
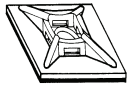
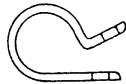
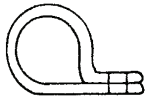

Shook carries a full line of...

Solderless Terminals & Wire Connectors

Nylon Cable Ties

Cable Clamps & Accessories

We also stock many hand tools to help make your job easier and more productive. When it comes to tools, think SHOOK as your supply source.

Shook provides its own line of quality tools that you just don't find every day. ***Shook Tools*** provide quality and serviceability at outstanding prices.



# "Jiffy Nuts" Wire Connectors

COLOR CODED  
FLAME RETARDANT  
SPRING INSERT

## RIBBED WIRE CONNECTORS

BAR CODE NUMBER	DESCRIPTION	RANGE	COLOR	PKG QTY
27000	RIBBED WIRE CONNECTOR	Min 2 #22 Max 2 #16	Gray	100 POS
27006	RIBBED WIRE CONNECTOR	Min 2 #22 Max 2 #16	Gray	500 PL BOX
27010	RIBBED WIRE CONNECTOR	Min 2 #22 Max 3 #16	Blue	100 POS
27012	RIBBED WIRE CONNECTOR	Min 2 #22 Max 3 #16	Blue	100 PL HANG PK
27016	RIBBED WIRE CONNECTOR	Min 2 #22, Max 3 #16	Blue	500 PL BOX
27020	RIBBED WIRE CONNECTOR	Min 1 #18, 1-#20, Max 4 #16 & 1 #20	Orange	100 POS
27022	RIBBED WIRE CONNECTOR	Min 1 #18, 1-#20, Max 4 #16 & 1 #20	Orange	100 PL HANG PK
27024	RIBBED WIRE CONNECTOR	Min 1 #18, 1-#20, Max 4 #16 & 1 #20	Orange	20 POS
27026	RIBBED WIRE CONNECTOR	Min 1 #18, 1-#20, Max 4 #16 & 1 #20	Orange	500 PL BOX
27032	RIBBED WIRE CONNECTOR	Min 3 # 20, Max 2 #10 & 1 # 12	Yellow	100 POS
27034	RIBBED WIRE CONNECTOR	Min 1 #14 & 2 #18, Max 1 #10 & 2 # 14	Yellow	100 PL HANG PK
27036	RIBBED WIRE CONNECTOR	Min 1 #14 & 2 #18, Max 1 #10 & 2 # 14	Yellow	20 POS
27044	RIBBED WIRE CONNECTOR	Min 3 #18, Max 3 #10	Red	100 POS
27046	RIBBED WIRE CONNECTOR	Min 3 #18, Max 3 #10	Red	100 PL HANG PK
27047	RIBBED WIRE CONNECTOR	Min 3 #18, Max 3 #10	Red	25 POS
27048	RIBBED WIRE CONNECTOR	Min 3 #18, Max 3 #10	Red	10 POS

### DOUBLE WING WIRE CONNECTOR

27074	RIBBED WIRE CONNECTOR	Min 2- # 18, Max 3- #12	Yellow	50 PL HANG PK
-------	-----------------------	-------------------------	--------	---------------

Bar Code Number	Stud Size	Description	AWG	Color	Pkg. Qty.
27520	.250"	Full Vinyl Disconnect	22-18	Red	100 Bag
27522	.250"	Full Vinyl Disconnect	22-18	Red	100 PI Box
27524	.250"	Full Vinyl Disconnect	22-18	Red	20 POS
27540	.250"	Full Vinyl Disconnect	16-14	Blue	20 POS
27542	.250"	Full Vinyl Disconnect	16-14	Blue	500 PI Box

## VINYL INSULATED FEMALE DISCONNECTS

Bar Code Number	Stud Size	Description	AWG	Color	Pkg. Qty.
27568	.187"	Vinyl Insulated Disconnect	22-18	Red	100 Bag
27584	.250"	Vinyl Insulated Disconnect	22-18	Red	100 Bag
27586	.250"	Vinyl Insulated Disconnect	22-18	Red	100 PI Box
27600	.187"	Vinyl Insulated Disconnect	16-14	Blue	100 Bag
27616	.250"	Vinyl Insulated Disconnect	16-14	Blue	100 Bag
27618	.250"	Vinyl Insulated Disconnect	16-14	Blue	100 PI Box
27624	.250"	Vinyl Insulated Disconnect	12-10	Yellow	100 Bag
27626	.250"	Vinyl Insulated Disconnect	12-10	Yellow	100 PI Box

## VINYL INSULATED BUTT CONNECTORS BUTTED SEAM

Bar Code	Item Description	AWG	Color	Pkg. Qty.
27982	Vinyl Insulated Butt Connector	22-18	Red	100 Bag
27990	Vinyl Insulated Butt Connector	16-14	Blue	100 Bag
27998	Vinyl Insulated Butt Connector	12-10	Yellow	100 Bag



## Disconnects

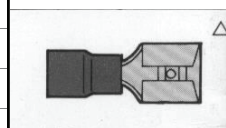

# “Jiffy” Cable Accessories

## NYLON CABLE TIES

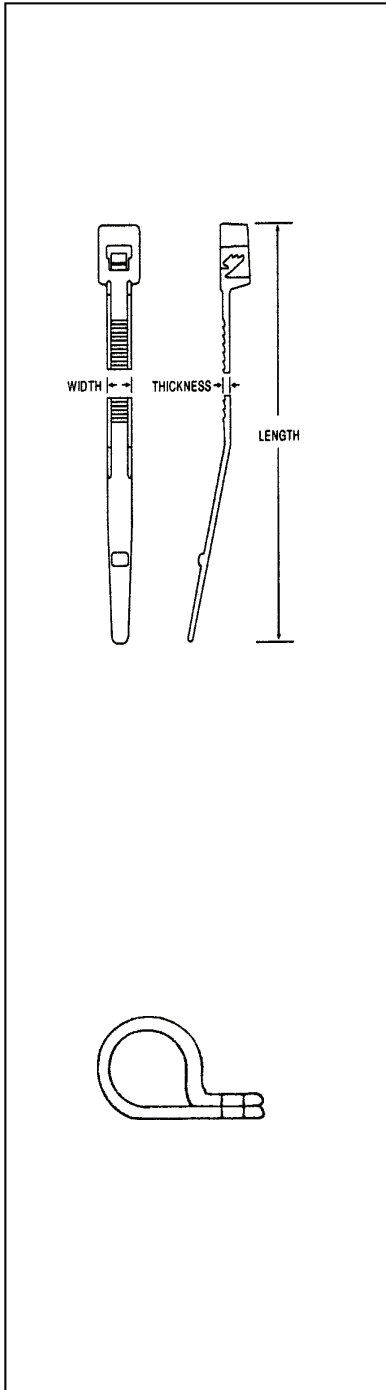

Bar Code #	Item Description	Color	Length Inch	Width	Thick	Tensile lbs.	Pkg. Qty.
14900	Nylon Wire Tie	Natural	4"	.094"	.042"	18	1000 PL Bag
14902	Nylon Wire Tie	Natural	6"	.094"	.042"	18	100 PI Bag
14104	Nylon Wire Tie	Natural	7"	.178"	.053"	50	100 PI Bag
14930	Nylon Wire Tie	Natural	7"	.178"	.053"	50	1000 PI Bag
14108	Nylon Wire Tie	Natural	11"	.178"	.053"	50	100 PI Bag
14110	Nylon Wire Tie	Natural	14"	.178"	.053"	50	100 PI Bag
14940	Nylon Wire Tie	Black UV	6"	.094"	.042"	18	100 PI Bag
14942	Nylon Wire Tie	Black UV	6"	.094"	.042"	18	1000 PI Bag
14944	Nylon Wire Tie	Black UV	8"	.094"	.042"	18	100 PI Bag
14112	Nylon Wire Tie	Black UV	7"	.178"	.053"	50	100 PI Bag
14116	Nylon Wire Tie	Black UV	11"	.178"	.053"	50	100 PI Bag
14970	Nylon Wire Tie	Black UV	14"	.178"	.053"	50	500 PI Bag
14120	Nylon Wire Tie	Natural	15"	.300"	.075"	120	100 PI Bag
14124	Nylon Wire Tie	Black UV	15"	.300"	.075"	120	100 PI Bag
14128	Nylon Wire Tie	Natural	24"	.339"	.084"	120	50 PI Bag

# “Jiffy” Cable Accessories

## NYLON CABLE CLAMPS

Bar Code Number	Item Description	Size	Pkg. Qty.
27136	Nylon Cable Clamp	1/4"	100 Bag/Box
27138	Nylon Cable Clamp	1/4"	100 PI Box
27140	Nylon Cable Clamp	1/4 "	20 POS
27152	Nylon Cable Clamp	3/8"	100 Bag/Box
27160	Nylon Cable Clamp	1/2"	100 Bag/Box
27164	Nylon Cable Clamp	1/2"	20 POS
27184	Nylon Cable Clamp	3/4"	100 Bag/Box

# Section 66

## PLUMBING ACCESSORIES & MISC. PRODUCTS

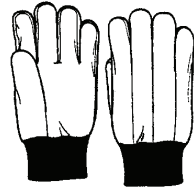
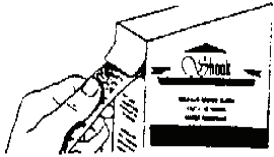

**-Abrasive Cloth**

**-Abrasive Mesh**

**-REMS Pipeworking Equip.**

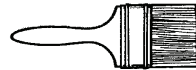
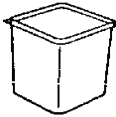

**-Gloves**

**-Tool Boxes & Totes**

**-Packaging Containers**

**-Lubricants**

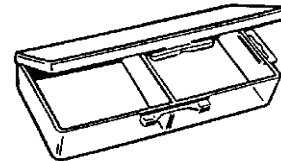

### Product Packaging Key

**POS** - Individually packaged for POS (boxed, bagged or carded) for hanging display

**CB** - Counter Bowl (Plastic)

**D** - Multiple Display Card

**HP** - Hang Pack - (Clear Plastic Hang Box or Bag)

**PL** - Plastic Box or Plastic Tub

**PB** - Plastic Bucket with Handle

**C** - Chipboard Box

**B** - Bulk Packaged - (Loose - Bagged - Boxed)

**JP** - Jiffy Pail, Handle, & Lid

All Bulk Packaging includes quantity, product description and barcode number

Custom Packaging and Labeling is Available

# “Jiffy” Tools - Plumber’s Supplies

## Plumber’s Abrasive Roll

**Aluminum Oxide Cloth – Closed Coat, 120 grit, Brown Cloth**

Aluminum oxide, high quality 120 grit, abrasive cloth to thoroughly clean copper and steel tubing.

Works wet or dry.

Exceeds industry standards for abrasive cloth.

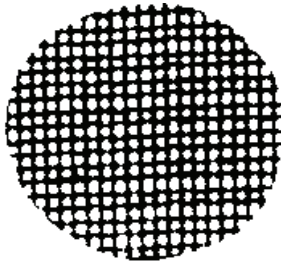

Bar Code Number	Item Description	Quantity
13800	Abrasive Cloth – 1-1/2” x 10 YD	1 Each
13802	Abrasive Cloth – 1-1/2” x 25 YD	1 Each

**Open Mesh Sand Screen Cloth – 180 Grit – 100% Waterproof**

Aluminum oxide grain resin bonded to synthetic nylon cloth.

100% waterproof, but can also be used for dry sanding by hand or with portable tools.

Most effective where clogging is a problem, such as soft materials.

13806	Abrasive Cloth – 1-1/2” x 10 YD	1 Each
-------	---------------------------------	--------

## Jiffy” Threaded Rod Cutter

Precision clean cut design protects threads

No cleaning threads– Just screw on nuts Easy to replace blade

15359	Threaded Rod Cutter– 3/8”	1
15361	Dies for Threaded Rod Cutter	1
15365	Dual Threaded Rod Cutter– 3/8” & 1/2”	1
15363	Ratcheting Threaded Rod Cutter– 3/8”	1

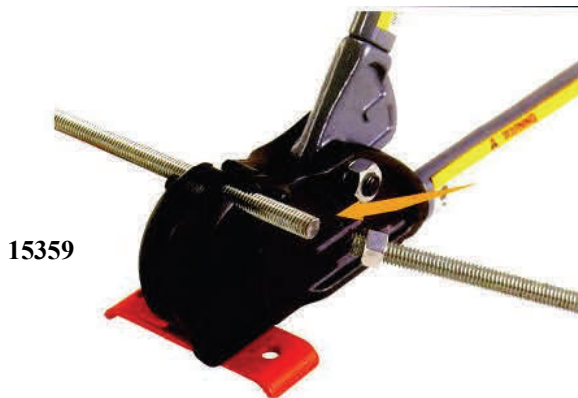

15359



15365

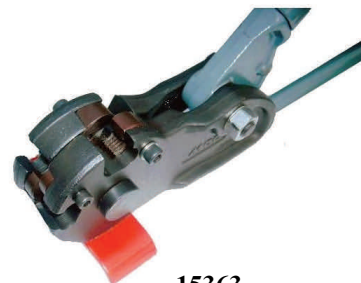

15363



**REMS****MACHINES AND TOOLS FOR PIPEWORKING**

DUE TO FLUCTUATION OF THE EURO PLEASE CALL FOR NET PRICING

Bar Code	Model	Description	REMS P/N	Sizes/Capacity	Pkg Qty
00650	Swing	Hand Tube Bender Set For soft copper	153021	3-8", 1/2", 5/8", 3/4", 7/8"	1
00729	Amigo 2 Set	Electric Die Stock for Pipe Threading	540021	1/2", 3/4", 1", 1-1/4", 1-1/2", 2"	1
00730	Amigo Set	Electric Die Stock for Pipe Threading	540024	1/2"-1"	1
00731	Amigo 2 Compact	Electric Die Stock for Pipe Threading	540026	1/2", 3/4", 1", 1-1/4"	1
00859	Amigo 2 Compact	Electric Die Stock for Pipe Threading	540027		
00735	Panther ANC VE	Universal Electric Reciprocating Saw 1 Blade Included	560026	Cuts Steel Pipe to 6"	1
00864	Akku-Press A	Cordless Press including tongs thru 2"	571013		1
00770	Power Press SE	Universal Corded Press for all Common Pressfitting Systems. Pressing Tongs Sold Separately	572111		1
00863	Akku-Press ACC	Universal Corded Press including tongs thru 2"	571014		1
00776	Curvo Set	Electric Pipe Bender	580024	3/8" - 7/8"	1
00164	Spezial	Water base Thread Cutting Oil	140105	20.3 oz. Spray	1
00644	Spezial	Water base Thread Cutting Oil	140100	1.32 Gal.	1

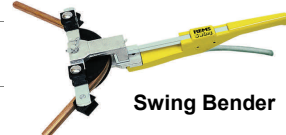
**Amigo 2****Swing Bender****Akku-Press****Curvo Electric Bender****Hot Dog 2****Spezial Cutting Oil**

Please ask for a REMS catalog for full details on these and other products.

## Jiffy Copper Tubing Bender Kit

Bend 3/8" to 7/8" Soft Copper Tubing  
Also Bends Multi-Layer Composite Tubes 10 mm thru 22mm  
Includes Case, Tubing Cutter and Reamer

**00902 Jiffy Tubing Bender****1 Ea.**

[www.shookmfg.com](http://www.shookmfg.com)

# Packaging Containers

## Plastic Containers

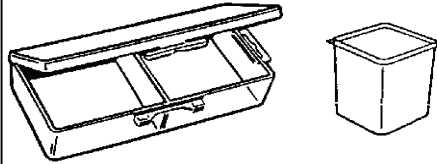

Bar Code Number	Item Description	Quantity Packaging
40001	Plastic Container – 1 Pint	36
40003	Plastic Container – 1-1/2 Pint	30
40005	Plastic Container – 1 Quart	24
40007	Plastic Container – 2 Compartment	1
40009	Plastic Container – 6 Compartment	1

## “Jiffy” Lubricants

**“BLASTER”**

### PRODUCTS

Bar Code Number	Item Description	B'laster Part No.	Pkg. Qty
09002	PB Penetrating Catalyst - 11 oz.	1-PB-16	12

## GLOVES

## “Jiffy” Safety Apparel

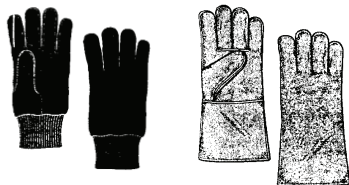
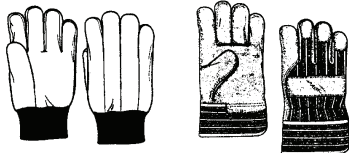

Bar Code Number	Item Description	Stock No.	Pkg. Qty.
20007	String Knit PVC Dots Both Sides	7460	1
20080	Gloves - Blue Latex Coating String Knit	708SLC	1
20009	Brown Jersey-100% Cotton	7500	1
20019	100% Kevlar Knit Double Dot	19800	1
20031	Split Leather Palm Knit	3000	1
20060	Heavy Foam Insulated PVC Orange Safety Cuff	9111	1

OTHER STYLES AVAILABLE IN CASE QUANTITIES. REQUEST SEPARATE FLYER

## ADHESIVE AND PAINT BRUSHES

Pure white natural bristles  
Unfinished, sanded wood handle

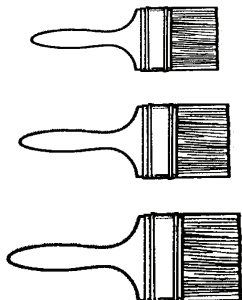

Bar Code Number	Item Description	Pkg. Qty.
14222	1" brush - wood handle 36/Box	1 Box
14226	2" brush - wood handle 24/Box	1 Box
14230	3" brush - wood handle 12/Box	1 Box

# JIFFY POINT & DRILTIP HIGH HAT HEAD SCREWS

SHARP DRILL POINT.  
NO WALKING.  
EASIER PENETRATION.  
FOR USE ON UP TO 3/16"  
THICK STEEL.



HEX HEAD UP TO 35%  
HIGHER THAN STANDARD.  
MORE SECURE DRIVING OF  
SCREW.

ZINC PLATED

BAR CODE	DESCRIPTION	HEAD	PKG QTY
30731	10 X 3/4 HIGH HAT DRILTIP SCREW	5/16"	100 BOX
30733	10 X 3/4 HIGH HAT DRILTIP SCREW	5/16"	500 PL BOX
30737	10 X 3/4 HIGH HAT DRILTIP SCREW	5/16"	500 PL JAR W/ CHUCK
30739	10 X 3/4 HIGH HAT DRILTIP SCREW	5/16"	1M BOX
11285	10 X 3/4 HIGH HAT DRILTIP SCREW	5/16"	6M BULK
11291	10 X 3/4 HIGH HAT DRILTIP SCREW	5/16"	6M JIFFY PAIL

SHARP HARDENED POINT FOR  
EASY PENETRATION.  
THREAD DESIGNED TO HOLD  
TIGHT.

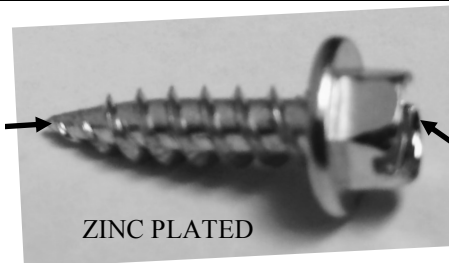

SLOTTED HEX HEAD UP TO 35%  
HIGHER THAN STANDARD.  
MORE SECURE DRIVING OF  
SCREW.

ZINC PLATED

BAR CODE	DESCRIPTIO	HEAD	PKG QTY
10709	10 X 1/2 HIGH HAT JIFFY POINT SCREW	5/16"	100 BOX
10711	10 X 1/2 HIGH HAT JIFFY POINT SCREW	5/16"	500 PL BOX
10713	10 X 1/2 HIGH HAT JIFFY POINT SCREW	5/16"	5M JIFFY PAIL
10715	10 X 1/2 HIGH HAT JIFFY POINT SCREW	5/16"	10M BULK
10735	10 X 3/4 HIGH HAT JIFFY POINT SCREW	5/16"	25 HP
10737	10 X 3/4 HIGH HAT JIFFY POINT SCREW	5/16"	100 BOX
10739	10 X 3/4 HIGH HAT JIFFY POINT SCREW	5/16"	100 HP
10755	10 X 3/4 HIGH HAT JIFFY POINT SCREW	5/16"	500 PL BOX
10759	10 X 3/4 HIGH HAT JIFFY POINT SCREW	5/16"	1M PL BOX
10767	10 X 3/4 HIGH HAT JIFFY POINT SCREW	5/16"	1M PL BOX W/ CHUCK
10731	10 X 3/4 HIGH HAT JIFFY POINT SCREW	5/16"	9M JIFFY PAIL
10733	10 X 3/4 HIGH HAT JIFFY POINT SCREW	5/16"	9M BULK
10701	10 X 1 HIGH HAT JIFFY POINT SCREW	5/16"	6M BULK
30687	10 X 1-1/2 HIGH HAT JIFFY POINT SCREW	5/16"	100 BOX
30681	10 X 1-1/2 HIGH HAT JIFFY POINT SCREW	5/16"	500 PL BOX
10717	10 X 2 HIGH HAT JIFFY POINT SCREW	5/16"	100 BOX
10719	10 X 2 HIGH HAT JIFFY POINT SCREW	5/16"	500 PL JAR
10707	10 X 2 HIGH HAT JIFFY POINT SCREW	5/16"	2M BULK

# SHOOK MANUFACTURED PRODUCTS, INC.

## PRIVATE LABEL BRAND PROGRAMS

Low inventory requirements - program minimums as low as 50 units per size and style

No additional charge for artwork development

Your company logo or brand identification and part number

No charge for bar coding

### PROGRAM BASICS:

- Establish items to be private labeled, place a blanket order for the agreed upon units per size and style.
- 
- Shook will build and release product against the distributor's incoming orders. When the amount released reaches 50% of the blanket order, Shook will automatically rebuild to the agreed upon stocking amount.
- 
- The distributor is obligated to provide Shook with an agreement to take any private label stock not released over a six month period.
- 
- Shook will notify the distributor's stocking status at six month intervals, thus providing an opportunity for the distributor to rebalance requirements.

Index	Page		
		Drywall Screws	38
		Duct Knives	63
		Duct Stretchers	64
		Ductboard Tools	63
		Electric Accessories	73-74
		Electrical Terminals	73
		Expansion Shield Anchors	41
		EZ Anchors	49
		Fairmont Tongs	68
		Fender Washers	44
		Flat Washers	42, 44
		Folding Tools	63
		Framing Screws	37
		Gloves	78
		Hammer Drill Bits	54
		Hammers	66
		Hand Tools	65-70
		Hanger Bolt Driver	6
		Hangermate Rod Hangers	58-59
		Hex Cap Screws	55
		Hex Chucks	2-4, 6-7
		Hex Drivers / Extensions	6
		Hex Key Sets	69
		Hex Nuts	43
		Hex Power / Insert Bits	10-15
		Hex Power Bit Adaptor	6
		<b>High Hat Screws</b>	<b>79 ***NEW***</b>
		Hole Cutters	63
		Insert Bits	10-13
		Impact Chucks	5
		J-Bolts	55
		Jiffy Chucks	2-7
		Jiffy Chuck Assortments & Displays	7
		Jiffy Grip Chucks	5
		Jiffy Nuts Wire Connectors	73
		Jiffy Pails	25, 33
		Jiffy Point Screws	19-28
		<b>SEE NEXT PAGE</b>	
Abrasive Cloth, Plumber's Roll	76		
Abrasive Mesh	76		
Adhesive Brushes	78		
Anchor Kits	48-49		
Anchors	40-41, 47-49		
Assortments	50 -51		
Aviation Snips	67		
Awls	64		
Bell Hanger Drill Bits	54		
Bi-Metal Saw Blades	70		
Bit Holders	9		
Bit Kits	12		
B'laster Penetrants	78		
Blued Panning Nails	64		
Bonded Sealing Washers	33		
Bulldog Snips	67		
Butt Connectors	73		
Cable Clamps - Nylon	74		
Cable Ties	74		
Carriage Bolts	55		
Chemicals & Lubricants	77-78		
Clutch Bits	14		
Combo Pan Head Sheet Metal Screws	35		
Concrete Screw Installation Kit	40		
Concrete Screw Drill Bits	39		
Concrete Screws	39		
Conical Plastic Anchors	47		
Coupling Nuts	46		
Crimpers	68		
Dampers, Damper Hardware	61-62		
Deck Screws	38		
Digi-Cool	16		
Disconnects	73		
Double End Drill Bits	51		
Drill Bits	51-54		
Drill Bits w Hex Power Shank	53-54		
Drilltip (Bit Tip) Screws	29-34		
Drilltip (Bit Tip) Screws - Hex Slotted	32		
Drive Extensions	6		
Drive Pins	47		
Drive Pin Setting Tool	47		
Drop-In Anchors	40		

INDEX	PAGE		
Jiffy Quick Change Extension	6	Saw Blades	70
Jiffy Tapping Screws	34	Screw Assortments	50-51
Jiffy Power Shears	69	SDS Hammer Drill Bits	54
Jiffy Aviation Snips	67	Sealing Washers	33
		Seamers	68
Kett Power Tools	69	Self Drilling Screws (Drilltip)	29-34
Knives, Ductboard	63	Self Piercing Screws	34-37
		Setting Tools	40
Lead Anchors	41	Sheet Metal Tools	63-64, 68
Lock Nuts	43	Sleeve Anchors	40
Lock Washers	44	Spade Wood Bits	53
Lubricants	71, 77-78	Stainless Steel Screws	34
		Staplers	63
Magnetic Nut Drivers	2-7	Staples, Ductboard	63
Masonry Drill Bits	52	Step Drills	53
Masonry Drill Bits w Hex Power Shank	53	Stove Bolts	42
		Super Jiffy Point Screws	27
Nutsetters- Jiffy Chucks	2-7		
Nylon Wire Ties	74	Tap Bolts	55
		Tapping Screws (Combo Pan Head)	35
Packaging Containers	78	Terminals, Electrical	78-79
Painted Speed Screws	36-37	Thread Cutting Oil	77
Plastic Anchors	47-49	Threaded Rod & Cutter	46
Plumber's Abrasive Roll	76	Tinners Hammers	66
Power Bits	13-14	Tin Snips, Aviation	67, 69
Power Shears	69	Toggle Bolts	47
<b>Private Label Program</b>	<b>80 ***NEW</b>	Toggle Wings	47
		Torpedo Levels	66
Quick Change Adapters	6-7	Tubing Bender	77
Quick Change Power Extensions	6		
		Vertigo Rod Hangers & Kits	56-57
Reciprocating Saw Blades	70		
Refrigeration Analyzer	16	Warm Air Dampers	62
Refrigeration Bits	15	Washers	33, 42, 44
Refrigeration Service Tools & Kits	15	Wedge Anchors	41
Refrigeration Wrenches	15	Wing Nuts	43
Register Screws	28	Wire Nuts	73
REMS Pipeworking Tools	77	Wood Screws	37
Rivet Tools	45	Wrenches, Refrigeration	15
Rivets	44-45		
Rod Hangers	40		
Rod Hanger Cross Reference	57		



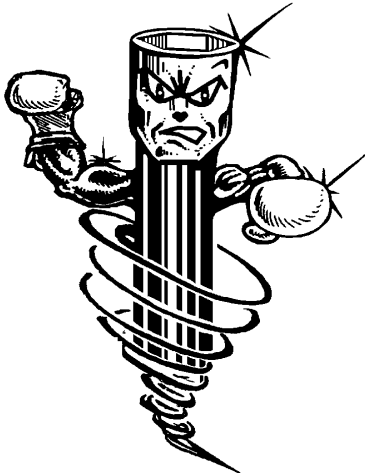

## "JIFFY" Aviation Snip Planograms

All Planograms come with a display board & hooks (a \$25.00 value) @ n/c

BARCODE #	DESCRIPTION	QTY.
13960	Left Cut, Red Handle	6
13964	Right Cut, Green Handle	6
13968	Straight Cut, Yellow Handle	2
13961	Offset, Left Cut, Right Hand, Red Handle	6
13963	Offset, Right Cut, Left Hand, Green Handle	6
13967	Bulldog	2
13965	Longcut	2
13958	Offset, Left Vertical	2
13959	Offset, Right Vertical	2
<b>13957</b>	<b>COMPLETE PLANOGRAM A - 34 PIECES</b>	
BARCODE #	DESCRIPTION	QTY.
13960	Left Cut, Red Handle	6
13964	Right Cut, Green Handle	6
13968	Straight Cut, Yellow Handle	2
13961	Offset, Left Cut, Right Hand, Red Handle	6
13963	Offset, Right Cut, Left Hand, Green Handle	6
13967	Bulldog	2
13965	Longcut	2
<b>13955</b>	<b>COMPLETE PLANOGRAM B - 30 PIECES</b>	
BARCODE #	DESCRIPTION	QTY.
13960	Left Cut, Red Handle	6
13964	Right Cut, Green Handle	6
13968	Straight Cut, Yellow Handle	2
13961	Offset, Left Cut, Right Hand, Red Handle	6
13963	Offset, Right Cut, Left Hand, Green Handle	6
<b>13953</b>	<b>COMPLETE PLANOGRAM C - 26 PIECES</b>	



See page 67 for more information on Jiffy Snips



Manufactured Products, Inc.  
P.O. Box 15058  
1017 Kenmore Blvd.  
Akron, OH 44314