

Large Bucket Bag

Heavy-duty construction-grade nylon. Fits over 5 gallon bucket. Organizes a wide range of tools for a job site. 42 exterior pockets, 10 interior pockets and tape holder.

No. WL104*



Bucket and Tools Not Included

Standard Nylon Tool Bag

Double layer of nylon and reinforced bottom make this light but strong. Large zippered opening with 6 inside and 6 outside pockets. Soft handles and shoulder strap for easy transport to and from the job site.

No. WL102* Size 20"x8-1/2"x13-1/2"



Professional Nylon Tool Bag

Double layer of nylon with heavy reinforced bottom makes this a perfect bag for the professional. Extra large zippered opening for tools and supplies. 14 inside pockets, 6 outside pockets, heavy-duty handles and shoulder strap.

No. WL103* Size 24"x10-1/2"x13-1/2"



Deluxe Canvas Tool Bags With Leather Bottom

Our finest quality heavy-duty canvas and leather reinforced bags for masons, mechanics and lineworkers. Made with 12 gauge steel hinged frame and heavy #10 canvas, this bag is made for heavy work and long-lasting wear. Leather reinforcing on the bottom and 3" up on the sides. Inside is a 9"x11" pocket. Waterproof bottom board.

No. WL200 Size 20"x14"
WL220 22"x14"



Deluxe Canvas Tool Bags

An expertly made bag, deep and roomy, built around a 12-gauge steel hinged frame. Leather handles, buckles and canvas are riveted into the frame. Lockstitched sewing assures long life. Inside is a 9"x11" pocket and a masonite bottom board provides waterproofing.

No. WL020 Size 20"x14"
WL024 24"x14"



Professional Canvas Bag With Outside Pockets

24" large capacity heavy-duty canvas bag. Soft durable canvas, leather handles and lockstitched sewing assures long life. Masonite bottom board for waterproofing. Interior pocket for organization. Interior pockets for organization. Exterior pockets for storage with easy reach. Masonite board for shape and waterproofing.

No. WL025 Size 24"x14"



Premium Leather Knee Pads

Genuine leather for long wear. Riveted construction of patented design allows user to walk with ease. Water resistant felt lining for comfort. Adjustable neoprene straps. Quick release on the swivel plastic buckle is convenient and comfortable.

No. WL089 Description 1" Thick Felt (Pair)



Economy Tool Bag

Economical 20" wide canvas tool bag. A lightweight but sturdy all-purpose bag. Two steel dowels are sewn into casings and a masonite bottom board holds the bag's shape. Two buckles secure top closed.

No. WL050 Size 20"x13"x12"



Professional Leather Bottom Bag

Heavy-duty, lightweight leather bottom canvas bag comes with tough nylon support handles. Convenient masonite bottom board holds the bag in shape and provides waterproofing.

No. WL224 Size 24"



Double Prong Leather Work Belt

Double leather work belt. Belt adjusts from 30" to 54". Reinforced back with double roller buckles. Quality stitching with solid rivets.

No. WL049



Leather Work Belt

General purpose work belt for nail bags and tool pouches. Fits 29" to 46" waist.

No.	Width	Description
WL099	2"	Deluxe
WL098	1-3/4"	Economy



Web Pistol Belt

Strong polypropylene web belt adjusts from 32" to 46" with hook-in fastener.

No. WL052



*See page 178

Plastic Bucket and Pail

Durable 90 mil 5 gal. translucent bucket and 10 qt. pail for general uses such as mixing or moving various materials. Lid for 5 gallon bucket sold separately.

5 Gal. Plastic Bucket

Liters, Quarts, Gallons measurements

No.	Description
GG468	5 Gal. Plastic Bucket
GG468-01	Plastic Lid (Fits GG468 5 Gal. Bucket)
GG468-02	Plastic Lid with Spout (Fits GG468 5 Gal. Bucket)

10 Qt. Plastic Pail

Ounces, Liters, Quarts measurements

No.	Description
GG470	10 Qt. Plastic Pail

Bucket Dolly

Strong molded plastic construction to move heavy buckets (sold separately).

No. ST379



FRONT

BACK

5 Gallon

10 Quart

GG468-02

Orange Latex Gloves

Sturdy latex gloves are resistant to most caustic chemicals, paints and sealers. Provides protection for hands from liquids and other materials. One size fits most.

No. GG426*

Sold 12 per Case Cut Carton



Professional Work Gloves

Lightweight yet durable. Features a neoprene cuff with Velcro® closure for a secure fit. Breathable spandex back provides ultimate comfort and fit.

No.	Size
GG488-M*	Medium
GG488-L*	Large
GG488-XL*	X-Large

Sold 12 per Case Cut Carton



Ultra Rubber Knee Pads

Durable, accordion style rubber knee pads with comfortable foam pad insert. Replaceable, adjustable strap available.

No. WL084* (pair)



EZ-Kneeler™ Kneeboard

No more sore knees. Comfortable, 1-1/2" thick foam cushion adhered to 14"x24" polypropylene tray, which protects cushion for long life. Cushion is washable and chemical resistant.

No. WL069



Dust Mask

Industry accepted N95 disposable respirator mask with foam nose cushion and two elastic straps. Box of 20 masks.

No. GG435*



Construction Boots

Excellent in wet/muddy conditions

Rugged, heavy-duty vinyl boots made of the finest materials and for the toughest construction work. Excellent in wet, muddy conditions. (boot height 16")

"Over The Sock" White Boot

Non-marking soles

No.	Size
GG907-WHITE	7 NEW
GG908-WHITE	8
GG909-WHITE	9
GG910-WHITE	10
GG911-WHITE	11
GG912-WHITE	12
GG913-WHITE	13



"Over The Sock" Black Boot

No.	Size
GG908	8
GG909	9
GG910	10
GG911	11
GG912	12
GG913	13



"Over The Shoe" Yellow Boot

No.	Size
GG918	8
GG919	9
GG920	10
GG921	11
GG922	12
GG923	13
GG924	14
GG925	15



RECOMMENDATION: Buy "Over the Shoe" boots 1-2 sizes larger than your regular shoe size.

More Plaster and
Drywall Tools
On Pages 134-153

HI-CRAFT® DRYWALL TOOLS



Vacuum Sander

Attach this sander to shop type vacs to clean as you sand; cutting down on time needed for a job. Multiple airflow channels to minimize dust. Adjustable vent allows control of vacuum force. Durable plastic construction. Elbow pivots 360° to keep the hose out of the way. Molded rubber padding on base for a smooth finish. Comfortable soft grip coating on handle. Easy to use knobs on clamps secure the screen. Use with Fabricut Screen Sandpaper, sold separately. Sander, 6' hose with coupler, adapter, sandscreen, and instructions included.

No.	Description
HC345*	Vacuum Sander with Hose
HC345-01*	6 Ft. Replacement Hose

Order in cartons
of 6 each



Hand Sander

Hard plastic fitted with a soft comfortable textured handle for improved grip. Padded sanding face provides a more uniform surface for sanding. Use with pre-cut drywall sandpaper or half of 8"x11" sheet.
No. HC341P*

Order in cartons
of 6 each



Pole Sander

Hard plastic sander makes sanding walls and ceilings easy. Padded face creates a more uniform surface for sanding. Use with pre-cut drywall sandpaper or half of 8"x11" sheet. The 360° swivel handle bracket accepts standard broom thread handle (sold separately).

No.	Description
HC217	Pole Sander (Head Only)
HC517-02M	48" Handle

Order in cartons
of 6 each



Metal Pole Sander

Lightweight aluminum pole sander has a padded face to create a uniform sanding surface. The bracket moves 180° for ease of movement on walls and ceilings. Includes a 48" vinyl-coated metal handle, or use any threaded broom handle (page 86). Fits pre-cut sandpaper or a half of an 8"x11" sheet.

No.	Size
HC517ASM*	Pole Sander with 48" Handle
HC517-01*	Pole Sander (Head Only)
HC517-02M	48" Replacement Handle

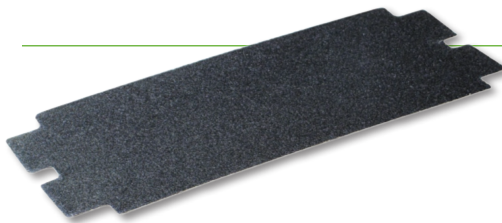

Diecut Sandpaper

Ideal for sanding down drywall joint mud or drywall board. Sheet size 11"x4-3/16".

No.	Grit	Sheets
DC080	80	100
DC100	100	100
DC083	120	100
DC084	150	100
DC082	80	10
DC102	100	10
DC103	120	10
DC104	150	10

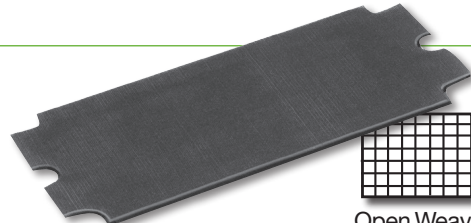

Open Weave

Diecut Fabricut Sandpaper

This open weave silicon carbide sanding cloth practically cleans itself. It lasts longer, and cuts joint mud faster than regular sandpaper, and is designed to not easily clog. Sheet size 11"x4-1/4". Use with Vacuum Sander.

No.	Grit	Sheets.
DC120	120	50
DC220	220	50
DC122	120	10
DC222	220	10

*See page 178

HI-CRAFT® DRYWALL TOOLS

Stainless Steel Threaded Handle Scrapers

Stainless steel bent scrapers with single bevel. Molded, threaded end can be used with standard broom threaded handle for extended reach (sold separately, see page 86). Handle has a comfortable contoured soft grip, for less fatigue.

No. HC534* 4"
HC537* 7"

Order in cartons of 5 each



Hammer End Putty and Joint Knives

Joint knives designed for many applications, including drywall and putty. Carbon blades ground for flexibility. Nylon handle has brass plated hammer end for nail setting.

No. HC527* 1-1/2"
HC528* 2"
HC529* 4"
HC530* 5"
HC533* 6"

Order in cartons of 5 each



5 in 1 Combination Tool

5 tools in 1; scraper, seam opener, spreader, putty remover and a cutout to remove paint from rollers. Brass plated hammer end for nail setting. 2-1/2" wide blade.

No. HC524*

Order in cartons of 5 each



Diamond-Shaped Joint Knife

This pie-shaped knife works in corners and around doors and windows without changing the position of the tool. 3-1/4" polished steel work surface. Brass plated hammer end for nail setting.

No. HC522*

Order in cartons of 5 each



Clipped Angle Joint Knife

Angle gives the proper amount of pressure in hard-to-reach places and awkward corners and angles. 6" polished steel work surface. Brass plated hammer end for nail setting.

No. HC523*

Order in cartons of 5 each



DIY Drywall Repair Kit

This 7-piece kit contains the basic tools needed for small to intermediate drywall repairs around the house. Mix your material in the hard plastic **Mud Pan**. An 8" flexible **Blue Steel Taping Knife** has a balanced wide plastic handle for clean taping. Three sizes of **Plastic Joint Knives** (2", 4", and 6") allow versatility for small jobs or filling a nail hole to patching walls. Use the 3-sided **Corner Tool** for finishing inside or outside corners. All of the knives feature hang holes for easy storage. Create a smooth finish to your project with the medium grit **Sanding Sponge**.

No. HC100*

No.	Description	Carton Qty.
HC100*	DIY Drywall Repair Kit	6
DW210	Plastic Mud Pan	6
DW648	8"x3" Blue Steel Taping Knife with Wide Plastic Handle	6
HC096	3-Sided Plastic Corner Tool	24
HC097	2" Plastic Joint Knife	36
HC098	4" Plastic Joint Knife	36
HC099	6" Plastic Joint Knife	24
HC216*	Sanding Sponge (Package of 4)	6



HC096
Order in cartons of 24 each



HC097
Order in cartons of 36 each



HC098
Order in cartons of 36 each



HC099
Order in cartons of 24 each

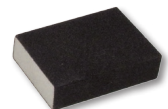

HC216
Order in cartons of 6 each

Texture Gun and Hopper

The Hi-Craft® texture gun and hopper is lightweight and easy to use. Hopper is made from molded high impact plastic. Sprays variety of drywall textures including stucco and decking material. Aluminum gun comes complete with 2 air nozzles, adjustable orifice plate for texture adjustment, locking trigger system for less fatigue and large 2 gallon hopper. Hopper has built in angle for maximum fill and operates on 6.25 C.F.M. free air at 25 P.S.I.

No. HC501



Drywall Taper

Taper is made of lightweight aluminum with separate mud and tape compartments. Holds up to 500' roll of tape. Easy to adjust mud metering blade. Comes with wood and nylon strap handles. Instructions included.

No.	Description
HC540*	Drywall Taper
HC540-01*	Replacement Blade
HC540-02*	Wood and Handle Strap Assembly



Lift 'n' Carry Panel Mover

One person can carry up to 150 lbs. of drywall, panel board, plywood, or wallboard with this lightweight molded plastic tool. Handle is angled to keep material away from hands. Rubber pads to prevent shifting.

No. HC545*



Order in cartons of 6 each



Texture Float

Special formula green plastic foam. Does an excellent job on any sand surface including plaster, drywall, and concrete. Comes with comfortable plastic handle

Coarse Texture

No.	Size
HC132	10"x4"x3/4"
HC134	12"x4"x3/4"
HC136	12"x5"x1"
HC138	12"x5"x3/4"

Fine Texture

No.	Size
HC132F	10"x4"x3/4"
HC134F	12"x4"x3/4"
HC136F	12"x5"x1"
HC138F	12"x5"x3/4"



Order in cartons of 50 each

Drywall Hammer

Checked face on 14 oz. polished head securely attached to a 16" wood handle for perfect balance.

No. HC535*



Order in cartons of 4 each

EIFS Float

Use for a textured finish on EIFS material and stucco. The white blade will not discolor materials. The completely smooth blade is made of durable break-resistant lightweight plastic. Rounded corners and edges allow for continuous application without gouging. Comfortable textured plastic handle and mounting are securely attached to top plate.

No.	Size
HC797*	12"x5"

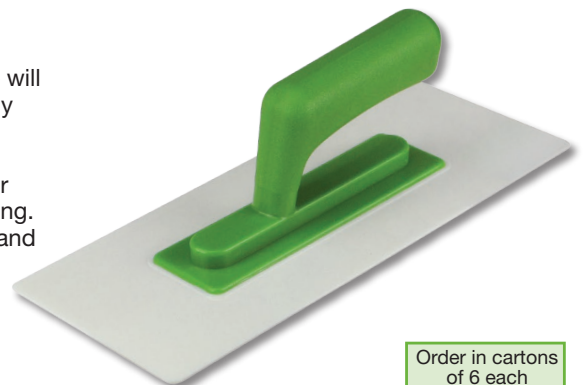

Order in cartons of 6 each



Order in cartons of 2 each

No.	Size
HC24*	24"
HC48*	48"

Bamboo Levels

Environmentally friendly level. The laminated bamboo resists moisture that could cause warping. Stainless steel bindings provide additional strength. End caps preserve the integrity of the level when dropped. Two smooth hand holes make this lightweight level easy to maneuver. A hang hole provides storage. Offered in 24" and 48" lengths.



More Concrete Tools
On Pages 4-79

HI-CRAFT® CONCRETE TOOLS

Concrete Trowels

Carbon steel blade ground for smooth finishing. Strong aluminum mounting fitted with camel back wood handle or soft grip handle.

Wood	Soft Grip	Size
No. HC145*	No. HC145PF*	11"x4-1/2"
HC146*	HC146PF*	14"x4"
HC144*	HC144PF*	16"x4"
HC142*	HC142PF*	18"x4"

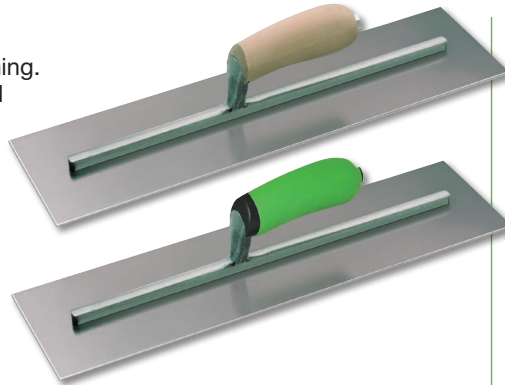

Order in cartons of 6 each

Economy Concrete Trowel

9"x4" steel blade mounted to contoured plastic handle.

No.	Size
HC166P*	9"x4"



Order in cartons of 12 each

Cali Mahogany Wood Float

Made of hard Asian Mahogany. Float is 3-1/2" wide and 1/2" thick. Fitted with a smooth wood handle.

No.	Size
HC160	12"x3-1/2"
HC161	14"x3-1/2"
HC162	16"x3-1/2"
HC164	18"x3-1/2"
HC165	20"x3-1/2"



Order in cartons of 6 each

Econo Mag Float

Float blade made of tough, durable extruded magnesium. Precise handle position creates perfect balance and superb floating action. Measures 16"x3-3/8".

No.	Handle
HC065	Wood
HC065PF	Soft Grip

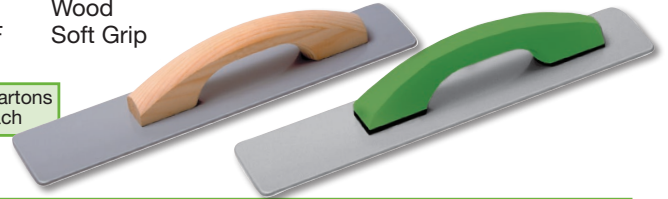

Order in cartons of 6 each

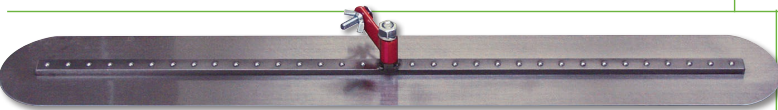

Fresno Trowels with Swivel Bracket

Round end fresno eliminates marking or gouging slabs. 360° all-angle bracket lets you work at any angle. Handle bracket accepts clevis wood handles or bull float handles with adapters (pages 22-24).

No.	Size	NEW
HC188*	18"x5"	
HC189*	24"x5"	
HC190*	36"x5"	
HC191*	48"x5"	

Fresno Weight

No. HC755 5 lb.
Using in pairs is recommended.
(Sold separately.)

Universal Groover

Popular among concrete finishers from coast to coast. Long-lasting steel groover is rivet free for a smooth finish. The 6"x3" blade has turned up ends to cut a clean 1/2"x1/2" groove.

No.	Handle
HC148*	Wood Handle
HC148PF*	Soft Grip Handle



Order in cartons of 6 each

Cast Aluminum Concrete Edger

Order in cartons of 6 each

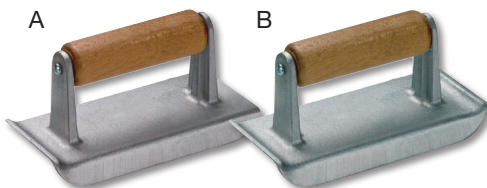

A) Front end turned up and back end straight			
No.	Size	Radius	Lip Depth
HC155	5-7/8"x2-7/8"	3/8"	3/4"
B) Both ends turned up			
No.	Size	Radius	Lip Depth
HC154	5-7/8"x2-5/8"	3/8"	1/2"

Cast Aluminum Concrete Groover

Order in cartons of 6 each

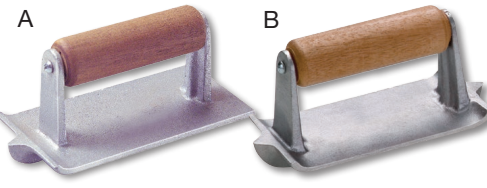

A) Front end turned up and back end straight				
No.	Size	Radius	Width	Depth
HC152	6"x2-3/4"	7/32"	3/8"	3/8"
B) Both ends turned up				
No.	Size	Radius	Width	Depth
HC153	5-3/4"x2-1/2"	13/64"	1/2"	1/2"

Concrete Edger

Order in cartons of 6 each



6"x3" carbon steel edger has 3/8" radius. Ends are turned up so it will not gouge concrete. Fitted with either wood or soft grip handle.

No.	Handle
HC147*	Wood
HC147PF*	Soft Grip

Rub Bricks

Fluted carbide rub bricks make dressing down concrete fast and easy. The fluted bricks are on a diagonal which provides sharp edges to help with stubborn materials while carrying away excess debris. Plastic handle

No.	Size	Grit
HC268*	8"x3-1/2"x1-1/2"	20
HC283*	6"x3"x1"	20



Pointed Sword Trowels

High carbon steel blade. Works well in tight corners and spaces. Soft handle and strong mounting for comfort and strength.

No.	Size
HC121*	14-1/4"x4-11/16"
HC123*	17-3/4"x4-1/2"



More Masonry Tools
On Pages 118-133

HI-CRAFT® MASONRY TOOLS

Narrow Pattern Brick Trowel

The narrow pattern brick trowel is great for work on brick, veneer and other small jobs. The blade is made of taper ground tempered steel for hardness. Available with wood or soft grip handle.

Wood		Soft Grip		Length
No.	No.	No.	No.	
HC 139*	HC139PF*	HC139PF*	HC139PF*	10"
HC705*	HC705PF*	HC705PF*	HC705PF*	11"

Order in cartons of 6 each



Wide Pattern Brick Trowel

The wide pattern brick trowel carries more mortar and is great for small jobs using concrete blocks. The blade is made of taper ground tempered steel for hardness. Available with wood or soft grip handle.

Wood		Soft Grip		Length
No.	No.	No.	No.	
HC149*	HC149PF*	HC149PF*	HC149PF*	10"

Order in cartons of 6 each



7" Gauging Trowel

Carbon steel blade is ground for flexibility. Perfect for mixing or transferring material. The blade is 7" long and 3-1/2" wide at heel. The perfect size for patching. Available with wood or soft grip handle.

No.	Handle
HC443*	Wood
HC443PF*	Soft Grip

Order in cartons of 6 each



Buttering / Tile Setter's Trowel

Tempered steel and taper ground. Blade measures 7"x4-3/8". Available with wood or soft grip handle.

No.	Handle
HC441*	Wood
HC441PF*	Soft Grip

Order in cartons of 6 each



Pointing and Margin Trowels

Blade is made of tempered steel, taper ground and fitted with wood or soft grip handle.

Wood Handle

No.	Blade Size
HC150*	Pointing 5"
HC422*	Pointing 5-1/2"
HC423*	Pointing 7"
HC431*	Margin 5"x1-1/2"
HC151*	Margin 5"x2"
HC433*	Margin 8"x2"

Soft Grip Handle

No.	Blade Size
HC150PF*	Pointing 5"
HC422PF*	Pointing 5-1/2"
HC423PF*	Pointing 7"
HC431PF*	Margin 5"x1-1/2"
HC151PF*	Margin 5"x2"
HC433PF*	Margin 8"x2"

Order in cartons of 6 each



Caulking Trowel

Trowels are made of carbon steel and ground for flexibility. Available with wood or soft grip handle.

Wood Handle

No.	Blade Size
HC761*	7"x3/16"
HC762*	7"x1/4"
HC763*	7"x3/8"
HC764*	7"x1/2"
HC765*	7"x5/8"
HC766*	7"x3/4"
HC768*	7"x1"

Soft Grip Handle

No.	Blade Size
HC761PF*	7"x3/16"
HC762PF*	7"x1/4"
HC763PF*	7"x3/8"
HC764PF*	7"x1/2"
HC765PF*	7"x5/8"
HC766PF*	7"x3/4"
HC768PF*	7"x1"

Order in cartons of 6 each

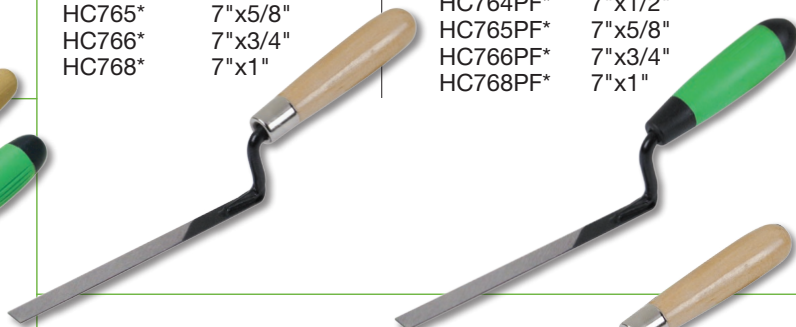

Cross Joint Trowel

5" blade of carbon steel for strength and flexibility. Tempered, ground and polished for perfect balance. Rounded end blade is excellent for applying mortar in small areas. Great for mixing, scraping, patching and repair. Available with wood or soft grip handle.

No.	Handle
HC445*	Wood
HC445PF*	Soft Grip

Order in cartons of 6 each



*See page 178

More Floor Covering Tools
On Pages 154-165

HI-CRAFT® FLOOR COVERING TOOLS

Notch Trowels

Hardened and tempered 11"x4-1/2" steel blade for wearability. Strong aluminum mounting with soft grip handle. Packed in case cut boxes of 6.

Order in Case Cut cartons of 6 each

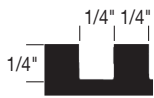

SQ

1/4"x1/4"x1/4"
HC404PFCC*

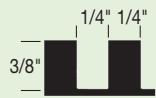

SQ

1/4"x3/8"x1/4"
HC411PFCC*

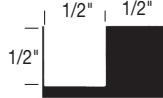

SQ

1/2"x1/2"x1/2"
HC412PFCC*

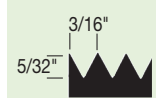

V

3/16"x5/32"
HC408PFCC*



U

3/4"x9/16"x3/8"
HC420PFCC*

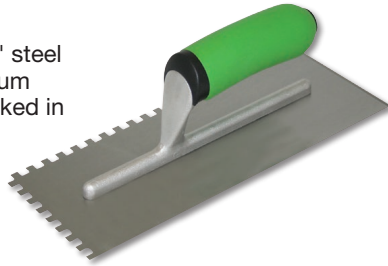

Tile Pliers / Nipper

Made of forged tool steel with 5/8" wide offset jaws. Carbide-tipped edges assure easy and accurate cutting of tile every time. Rubber coated handles for comfortable grip. Cuts wall tile, thin vitreous, and quarry tile. 8" length.

No. HC210*



Order in Case Cut cartons of 6 each

Grout Saw

Fitted with two blades. Use one blade for thin grout joints and two blades for thicker grout joints. Non-slip comfort handle with hang hole.

No.

HC174*

Order in Case Cut cartons of 6 each



Grout Floats

Closed cell pad with gum rubber face. Rounded corners in front, square corners in back. Non-marring top with beveled edges.

No.

HC395P*

Size

9-1/2"x4" Tile Grouter's Float



Closed cell foam rubber pad with non-marring top and plastic handle.

No.

HC396P*

Size

9"x3-1/4" Econo Grout Float



Order in Case Cut cartons of 6 each

Vinyl Knife

Hook axe knife with extra heavy, curved carbon steel sharp point for making even, accurate cuts in vinyl and linoleum. Comfortable, contoured soft grip handle.

No. HC300*

Order in Case Cut cartons of 5 each



Order in Case Cut cartons of 12 each

Economy Notch Trowel

Economy notch trowel with 9"x4" steel blade mounted to contoured plastic handle.

No.

HC167P*

Notch

SQ

Notch Size

1/4"x3/8"x1/4"

HC168P*

SQ

1/16"x1/16"x1/16"

HC169P*

SQ

1/4"x1/4"x1/4"

HC170P*

V

3/16"x5/32"

HC166P*

No Notch



Order in Case Cut cartons of 12 each

Adhesive Spreader

Economy stainless steel adhesive spreader with 9" cold rolled steel blade. Hang hole for easy display or storage.

No

HC305*

Notch

SQ

Size

1/4"x3/8"x1/4"

HC306*

Notch

SQ

1/16"x1/16"x1/16"

HC307*

Notch

SQ

1/4"x1/4"x1/4"

HC308*

Notch

V

3/16"x5/32"

Asphalt Trowel

Use the right angle edge like a shovel to apply filler material into cracks. Steel blade tamps down the material and edge helps smooth surfaces.

No. HC249PF*



Order in cartons of 6 each



More Asphalt Tools on pages 80-83



PROFESSIONAL LEVELS



Sands Level Online

A Kraft Tool Co.® Brand

Professional Cast Aluminum Levels



Contractor's red, super hard professional surface

Durable cast aluminum
Will not warp
Will not rust

No.	Length	Vials
SL1212	12" (305mm)	4
SL1818	18" (457mm)	6
SL2424	24" (610mm)	6
SL2828	28" (711mm)	6
SL3030	30" (762mm)	6
SL4848	48" (1219mm)	6
SL18YA18	18" (457mm)	5 (45 Degree Vial)
SL24YA24	24" (609mm)	5 (45 Degree Vial)

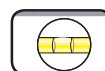
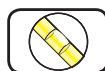

Precision milled frame for accurate work surface

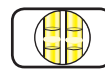

Solid Set Cat's Eye Yellow double bent vials for accuracy with protective lenses

Cast Aluminum Level Repair Kit
Includes: (6) lenses, (6) paper rings, (1) 8 oz. painter's putty and (1) aluminum putty tool
No. SL010

Guaranteed accurate to .0004" per inch

Professional Plumber's Cast Aluminum Level



Graduated 1/16" ruler on working surface on contractor's red edge

Durable cast aluminum
Will not warp
Will not rust

No.	Length	Vials
SL2424P	24" (610mm)	4

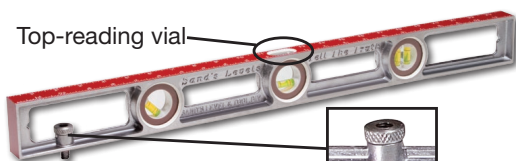

Top-reading vial

Threaded cap screw to adjust pitch

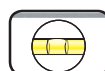

Precision milled frame for accurate work surface

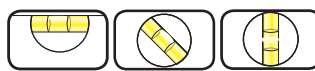

Four Solid Set vials: top-reading vial, 45 degree vial, and twin plumb vials

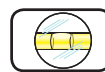

Solid Set Cat's Eye Yellow double bent vials for accuracy with protective glass lenses

Guaranteed accurate to .0004" per inch

Professional Top-Reading Magnetic Aluminum Extruded Levels



Full length magnetic strip

No.	Length	Vials
SLPML18	18" (457mm)	3
SLPML24	24" (610mm)	3
SLPML36	36" (914mm)	3
SLPML48	48" (1219mm)	3
SLPML72	72" (1829mm)	5
SLPML96	96" (2438mm)	5

Top-reading level



Heavy-duty extruded aluminum I-beam frame with strong magnetic strip

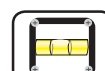

Special replaceable Solid Set acrylic Roto Vial® feature for accurate leveling in all directions

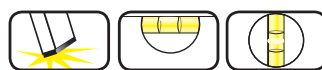

Shock absorbent end caps, Cat's Eye Yellow vials, top-reading window for the level vial, and two plumb vials

SANDS PROFESSIONAL MAHOGANY LEVELS

Wood Level Repair Kit

Includes: (6) lenses, (1) 8 oz. painter's putty, (1) aluminum putty tool and (1) 2 oz. raw linseed oil
No. SL011

Professional Top-Reading Mahogany I-Beam Levels



Heavy-duty aluminum I-beam frame for extra strength

No.	Length	Vials
SLTMI-24	24" (610mm)	5
SLTMI-48	48" (1219mm)	5

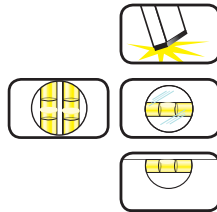

Shock absorber rubber end caps

Five Solid Set Cat's Eye Yellow double bent vials with protective glass lenses

Adjustable top vial for accuracy



Guaranteed accurate to .0004" per inch

Professional Mahogany Flat Brass Levels



Solid flat brass trim with screws makes it more durable

No.	Length	Vials
SL22BY24	24" (610mm)	6
SL22BY36	36" (914mm)	6
SL22BY42	42" (1067mm)	6
SL22BY48	48" (1219mm)	6

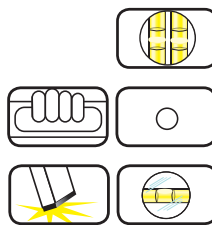

Six Solid Set Cat's Eye Yellow double bent vials for accuracy

Two large hand holes and one hang hole

Shock absorber rubber end caps and protective glass lenses

Guaranteed accurate to .0004" per inch

Professional Walnut/Maple Laminated Levels



Premium grade walnut/maple with flat stainless steel binding and wrap around end caps

No.	Length	Vials
SLWML24	24" (610mm)	6
SLWML36	36" (914mm)	6
SLWML42	42" (1067mm)	6
SLWML48	48" (1219mm)	6

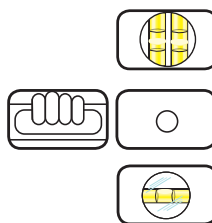

Six Solid Set Cat's Eye Yellow double bent vials for accuracy

Two large hand holes and one hang hole

Double strength glass lenses

Guaranteed accurate to .0004" per inch

Professional Mahogany Door Jamb Level

Use as a straightedge or for setting door jams



No.	Length	Vials
SLMA78R	77-3/4" (1975mm)	8



Adjustable solid aluminum rollers for checking plumb of door

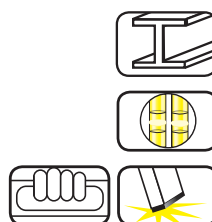

Heavy-duty aluminum I-beam frame for extra strength

Eight Solid Set Cat's Eye Yellow double bent vials for accuracy

Three large hand holes and shock absorber rubber end caps

Professional Mahogany I-Beam Levels



Heavy-duty aluminum I-beam frame for extra strength



No.	Length	Vials
SLMA24	24" (610mm)	6 with hand grooves
SLMA36	36" (914mm)	6
SLMA42	42" (1067mm)	6
SLMA48	48" (1219mm)	6
SLMA72	72" (1829mm)	8



Six Solid Set Cat's Eye Yellow double bent vials for accuracy with protective glass lenses



Two large hand holes and one hang hole



Shock absorbent rubber end caps

• Made from the finest selection of mahogany wood

Guaranteed accurate to .0004" per inch

Professional Brass Bound Mahogany Levels

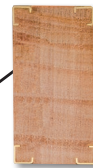

Angle bound brass binding embedded in wood for extra strength

No.	Length	Vials
SL12AB18	18" (457mm)	6 no hand holes
SL12AB24	24" (610mm)	6
SL12AB28	28" (711mm)	6
SL12AB36	36" (914mm)	6
SL12AB42	42" (1067mm)	6
SL12AB48	48" (1219mm)	6



Six Solid Set Cat's Eye Yellow double bent vials for accuracy with protective glass lenses



Two large hand holes and one hang hole



Shock absorbent rubber end caps

• Made from the finest selection of mahogany wood

Guaranteed accurate to .0004" per inch

Professional Stainless Steel Bound Mahogany Levels

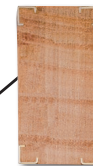

Angle bound NO RUST stainless steel binding on all edges

No.	Length	Vials
SL44SB24	24" (610mm)	6
SL44SB36	36" (914mm)	6
SL44SB42	42" (1067mm)	6
SL44SB48	48" (1219mm)	6



Six Solid Set Cat's Eye Yellow double bent vials for accuracy with protective glass lenses



Two large hand holes and one hang hole



Shock absorbent rubber end caps

• Made from the finest selection of mahogany wood

Professional Asphalt Mahogany I-Beam Level

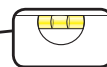
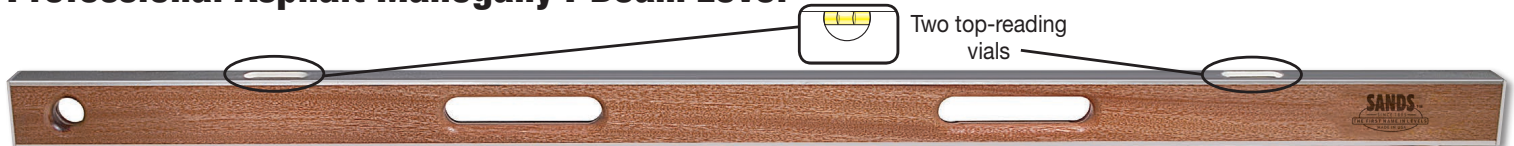

Two top-reading vials

No.	Length	Vials
SLAL48	48" (1219mm)	2



Heavy-duty aluminum I-beam frame for extra strength



Two top-reading Solid Set Cat's Eye Yellow double bent vials for accuracy



Two large hand holes and one hang hole for hanging

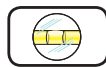

Protective glass lenses

• Designed to be used in asphalt construction - NO plastic parts
• Made from the finest selection of mahogany wood

Contractor Mahogany Carpenter Levels

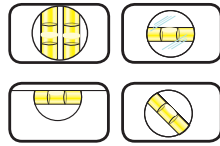

Solid Set Cat's Eye Yellow bent vials for accuracy with heavy protective glass lenses

Available with top-reading or 45 degree vials

Made from the finest selection of mahogany wood and double sealed with a smooth lacquer finish



No. SL67824 **Length** 24" (610mm) **Vials** (1) level vial (1) plumb vial



No. SL1024 **Length** 24" (610mm) **Vials** (1) level vial with top-reading and (1) plumb vial with hand grooves



No. SL11824 **Length** 24" (610mm) **Vials** (2) level vials and (2) plumb vials
 SL11824A (not shown) 24" (610mm) (2) level vials, (1) plumb vial and (1) 45 degree vial

With end caps



No. SL2018 **Length** 18" (457mm) **Vials** (1) level vial, (1) plumb vial and (1) 45 degree vial with hand grooves
 SL2024 24" (610mm) (1) level vial, (1) plumb vial and (1) 45 degree vial with hand holes
 SL2048 48" (1219mm) (1) level vial, (1) plumb vial and (1) 45 degree vial with hand holes

Guaranteed accurate to .0004" per inch

Guaranteed accurate to .0004" per inch



Professional Combo Packs

No.	Description
SL4848CAT	48" Cast Aluminum Level w/ Case & Torpedo Level
SL2424C	24" Cast Aluminum Level w/ Case
SL4848C	48" Cast Aluminum Level w/ Case
SL12AB24C	24" Brass Bound Mahogany Level w/ Case
SL12AB48C	48" Brass Bound Mahogany Level w/ Case
SLWML24C	24" Walnut/Maple Laminated Level w/ Case
SLWML48C	48" Walnut/Maple Laminated Level w/ Case



Professional Level Cases



Easy hang hook



Available in 6 sizes 24" to 96"

- Will protect and prolong the life of the level
- Easy open/close end with peg hook for hanging
- Durable high-impact styrene
- Opening measures 1-1/4"x2-1/2"
- Available in 6 sizes
- Fits most levels

No.	Length
SLPLC24	24" (610mm)
SLPLC36	36" (914mm)
SLPLC42	42" (1067mm)
SLPLC48	48" (1219mm)
SLPLC72	72" (1829mm)
SLPLC96	96" (2438mm)



Professional Digital Box Level

- Digital display stores measurements and helps you find exact angles, percentages, and pitches
- Splash and dust resistant
- Unique top-reading plumb vial for easy-reading accuracy
- 10 minute auto shut-off. Requires one 9 Volt battery (not included)

No.	Size	Description
SLDIG24*	24" (610mm)	1 Hand Hole
SLDIG48*	48" (1219mm)	2 Hand Holes
SLDIG24C*	24" (610mm)	Level with Case
SLDIG48C*	48" (1219mm)	Level with Case

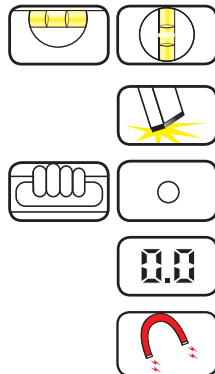

Top-reading level vial and plumb vial
Accurate to .005" per inch

Shock absorbent end caps

Hand hole(s) and one hang hole

Digital display
Accurate to 0.1" at level and plumb

Magnetic



Side and Top-Reading Plumb Vial



Professional Keyhole Box Level

- Top-reading level vial, unique side and top-reading plumb vial
- Accurate to .005" per inch
- Extra large center vial
- Shock absorbent end caps
- Bottom groove rests on curved surfaces
- Easy-to-grip keyhole shape
- Hand holes and one hang hole
- Does not fit Sands Level Cases

No.	Size	Description
SLK24*	24" (610mm)	1 Hand Hole
SLK48*	48" (1219mm)	2 Hand Holes

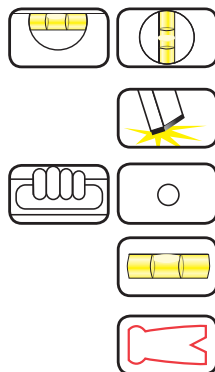

Top-reading level vial and two plumb vials
Accurate to .005" per inch

Shock absorbent end caps

Hand hole(s) and one hang hole

Extra large center vial

Easy-to-grip keyhole shape
Bottom groove to rest on curved surfaces



Side and Top-Reading Plumb Vial



Extra Large Center Vial



Professional LED Level

- Top-reading level vial
- Accurate to .0005" per inch
- Magnified top vial
- Shock absorbent end caps
- LEDs light up acrylic vials for high visibility
- Anodized precision milled aircraft aluminum
- Requires 2 AA batteries (not included)
- Does not fit Sands Level Cases

No.	Size
SLLED24*	24" (610mm)
SLLED48*	48" (1219mm)

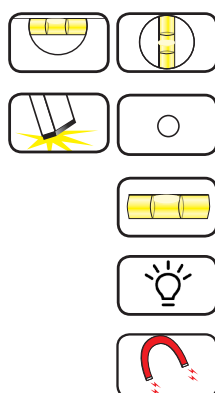

Top-reading level vial and two plumb vials
Accurate to .0005" per inch

Shock absorbent end caps
Two hang holes

Magnified top vial

LEDs light up vials

Rare earth magnets

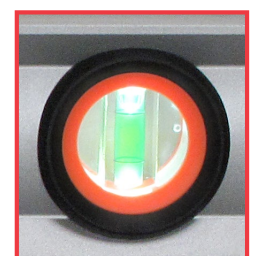

LEDs light up vials for high visibility

*See page 178

SANDS CONTRACTOR LEVELS



Sands Level
& Tool
Since 1895

Professional Aluminum Extruded Levels



Contractor's red with machined edge

I-Beam construction strong and lightweight

No.	Length	Vials
SLHD18	18" (457mm)	6
SLHD24	24" (610mm)	6
SLHD28	28" (711mm)	6
SLHD30	30" (762mm)	6
SLHD36	36" (914mm)	6
SLHD42	42" (1067mm)	6
SLHD48	48" (1219mm)	6
SLHD72	72" (1829mm)	10 (NO END CAPS)
SLHD78	78" (1981mm)	10 (NO END CAPS)
SLHD96	96" (2438mm)	10 (NO END CAPS)



Heavy-duty extruded aluminum I-beam frame



Strong, lightweight frame with shock absorbent end caps



Adjustable Cat's Eye Yellow double bent vials for accuracy with replaceable protective plastic lenses and vials

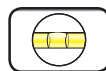

Precision milled frame for work surface accurate to .004" per inch

Professional Aluminum Box Levels



- Ribbed extruded, anodized aircraft aluminum frame
- Precision milled for accuracy
- Lightweight frame will not warp or twist
- Magnified center vial

No.	Length	Vials
SLBZ24*	24" (610mm)	3
SLBZ48*	48" (1219mm)	3
SLBZ72*	72" (1829mm)	3

Waterproof for easy clean-up of wet trades like tile and plaster



Top-reading window for level vial, one horizontal and two plumb vials



Bright yellow vials are accurate and consistent

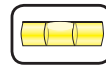

Magnified top vial

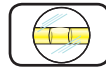

Strong acrylic vials

Guaranteed accurate to .0005" per inch

Professional Aluminum Box Levels with Hand Holes



- Ribbed extruded, anodized aircraft aluminum frame
- Precision milled for accuracy
- Lightweight frame will not warp or twist
- Magnified center vial
- Two hand holes with grips
- Does not fit Sands Level Cases

No.	Length	Vials
SLBZ24HH*	24" (610mm)	3
SLBZ48HH*	48" (1219mm)	3
SLBZ72HH*	72" (1829mm)	3

Waterproof for easy clean-up of wet trades like tile and plaster



Top-reading window for level vial, one horizontal and two plumb vials

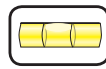

Magnified top vial



Shock absorbent end caps

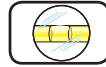

Bright yellow vials are accurate and consistent
Strong acrylic vials

Professional Magnesium Extruded Levels



No.	Length	Vials
SL024	24" (610mm)	6
SL028	28" (711mm)	6
SL048	48" (1219mm)	6
SL060	60" (1524mm)	8
SL072	72" (1829mm)	10
SL096	96" (2438mm)	10



30% lighter than aluminum



High quality Extru-Lite™ Magnesium I-beam frame is strong and 30% lighter than aluminum frame levels

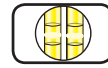

Adjustable Cat's Eye Yellow double bent vials for accuracy



Shock absorbent end caps

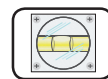

Replaceable protective plastic lenses and glass vials

Guaranteed accurate to .0004" per inch

Contractor Extruded Aluminum Levels

Easy-to-read English/Metric rule

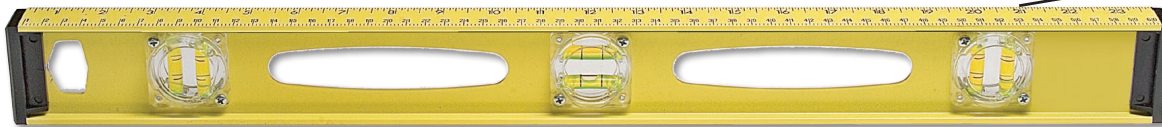

No.	Length	Vials
SLSC2212	12" (305mm)	2
SLSC2418	18" (457mm)	4
SLSC3624	24" (610mm)	6
SLSC3628	28" (711mm)	6
SLSC3636	36" (914mm)	6
SLSC3648	48" (1219mm)	6
SLSC4872	72" (1829mm)	8



Strong, lightweight aluminum I-beam frame

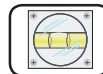

Cat's Eye Yellow double bent vials for accuracy with replaceable protective plastic lenses & vial



Two large hand holes and one hang hole



Shock absorbent end caps



Contractor Magnetic Extruded Aluminum Levels

Good for use on metal studs and door jambs. Easy-to-read English and Metric markings on top of level.

No.	Length	Vials
SLQML24	24" (610mm)	3
SLQML48	48" (1219mm)	3
SLQML72	72" (1829mm)	4



Solid set replaceable Roto Vial® protective plastic lenses and vials



Full length strong magnetic strip

Guaranteed accurate to .0004" per inch

Utility Aluminum Extruded Levels



No.	Length	Vials
SLPL218	18" (457mm)	2
SLPL318	18" (457mm)	3
SLPL224	24" (610mm)	2
SLPL324	24" (610mm)	3
SLPL336	36" (914mm)	3
SLPL348	48" (1219mm)	3



Lightweight extruded aluminum I-beam frame

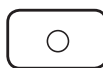

Two large hand holes and one hang hole



"V" groove on bottom of frame for use on round pipe, conduit or flat surfaces

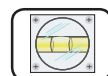

Solid set replaceable Roto Vial® protective plastic lenses and vials

• Engineered to meet the demands of the home handyman

All Torpedo Levels come with
 • One Level Vial • One Plumb Vial
 • One 45 Degree Vial

TORPEDO & SPECIALTY LEVELS

Professional 9" Aluminum Torpedo Level-3 Vial

Small size and aluminum frame makes a popular choice in welding.

No. SLSC50 Size 9" (229mm)



Professional 9" Magnetic Aluminum Torpedo Level-3 Vial

Small size magnetic level with aluminum frame makes a popular choice in welding.

No. SLSC50M Size 9" (229mm)



Contractor 9" Magnetic Plastic Torpedo Level-3 Vial

Rubber end caps stand up to the rigors of a jobsite.

No. SLPT12M* Size 9" (229mm)



Utility (DIY) 9" Magnetic Plastic Torpedo Level-3 Vial

Lightweight plastic and slim design is great for projects around the house.

No. SLPT9M* Size 9" (229mm)



Professional Specialty Levels

A) Aluminum Line and Surface Level

No. SLSC55 Length 3" (76mm) Vials 1

B) Aluminum Pocket Level

No. SL556 Length 5" (127mm) Vials 1

C) Plastic Line Level

No. SLPLL3 Length 3" (76mm) Vials 1

D) Cross Check Level

No. SL480* Vials 2

E) Bull's Eye Level

No. SL400*

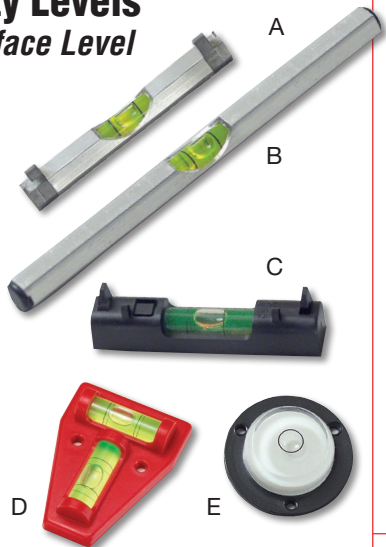

8" Billet Level

- 4 vials – 0°, 45°, 90°, and Variable Pitch
- Variable Pitch in 1/8" graduations up to 1/2"
- Laser etched Markings on bright yellow vials
- V-groove for use on pipes and rounded surfaces
- Strong aluminum alloy
- Powerful magnets

No. SL82B

Patent Pending



SL420
Magnetic Base



SL410

Contractor Dial Levels

- Easy-to-read degree graduations for setting angles
- Available magnetic and non-magnetic
- V groove for use on pipes

No. SL410* Description Non-Magnetic
 SL420* Magnetic

Pipe Level Set

Includes 5 Sizes

Easily measures slopes of pipes. Clip-on pipe level set includes five sizes to fit 1/2" to 2" thick steel, copper, plastic, and PVC pipes. Each clip features two vials for vertical and horizontal reading.

No. SL409*





Professional Brass Plumb Bob

- Removable cap for easy string installation
- Bright machined finish brass will not rust
- Ideal for finding vertical points
- Protective tool packaging

No.	Description
SL43*	8 oz.
SL42*	12 oz.
SL41*	16 oz.
SL40*	24 oz.
SL38*	32 oz.



Professional Steel Plumb Bob

- Bright plated finish
- Machined hexagonal steel
- Removable cap for easy string installation
- Ideal for finding vertical points

No.	Description
SL52C*	8 oz. Carded
SL51C*	12 oz. Carded

Rapid Square®

- Flat finish to prevent glare
- Durable, lightweight aluminum
- Easy-to-read dark, permanent graduations
- 7/8" lip rests on boards
- 5 tools in 1 (try square, miter square, protractor, inscriber and saw guide)

No.	Description
SLRS45	7" Rapid Square® with Manual
SLRS45B	7" Rapid Square® without Manual (Bulk pack 30)



With Manual



Professional Combination Squares

- Level vial in the head of the square
- Steel scribe and solid brass knurled thumb screw for adjustment
- Easy-to-read permanently etched graduations
- Available with plastic or zinc head
- Ideal for level, plumb and miter work

No.	Description
SLCS0	12" Plastic Head (304.8mm)
SLCS1	12" Zinc Head (304.8mm)
SLCS3	6" Zinc Head (152.4mm)

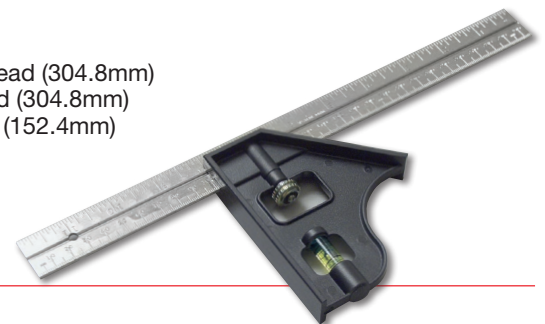

Professional Try and Mitre

- Hardened stainless steel blade
- Markings in inches and metric



No.	Description
SL430*	45° - 90°

Professional Sliding T-Bevel

- Chrome plated steel 8" (203.2mm) blade
- Solid plastic handle with hand groove and thumb locking screw for securing blade
- Used for testing bevels, duplicating angles and rafter cuts

No. SL440*



Contractor Carpenter Pencils

Flat style will not roll. Easy to sharpen.

No.	Description
SL450	Carded (2 per)
SL450B	Bulk Pack 72 (not carded)

Contractor Clear Redwood Floats

Quality redwood float with 5/8" thick blade. A popular choice for working color hardeners into decorative surfaces.

No.	Size
SL529	12"x5" (304.8mm x 127mm)
SL528	15"x3-1/2" (381mm x 88.9mm)



SL529



SL528
Beveled Front

*See page 178