

Self-Leveling Kit

Complete kit with all the items required to mix and install self-leveling products. Includes mixing barrel, measuring pitcher, oval mixer, spiked shoes, 20 self-leveling pins, gauge rake head, wood-framed stainless steel smoother and 5' 3-piece aluminum handle to fit gauge rake and smoother.

- | No. | Description |
|-------------|--|
| GG600 | Complete Self-Leveling Kit |
| A) GG601 | 15 Gal Mixing Barrel with Lid |
| B) GG602 | 5 Qt. Measuring Pitcher |
| C) GG603 | 24" Wood Frame Stainless Steel Smoother with Bracket |
| D) CC263 | 5' 3-piece Aluminum Handle (for Smoother and Gauge Rake) |
| E) HC178* | Hi-Craft™ Gunite Shoes |
| F) CC975-01 | 24" Gauge Rake/Leveler |
| G) DC717* | Oval Mixer (Zinc Plated Steel) |
| H) GG240* | 20 Self-Leveling Pins NEW |



Items can be ordered separately



Wood Frame Stainless Steel Smoother

24" stainless steel blade in laminated wood mounting. Used to apply and smooth coatings, especially self-leveling material. Can be used by hand or with standard broom thread handles (sold separately, see page 46).

- | No. | Description |
|----------|---|
| A) GG604 | 24" Smoother with Bracket and Built-in Handle |
| B) GG603 | 24" Smoother with Bracket |

Squeegee Trowel With Soft Grip Handle for Comfort

A contractor's favorite, used to smooth a variety of coatings in construction, drywall and concrete restoration. Includes blade protector for extended life. Can be used by hand or with threaded broom style handle (sold separately, see page 46).

- | No. | Description |
|----------|--------------------|
| GG242 | 12" |
| GG243 | 14" |
| GG244 | 18" |
| GG246 | 22" |
| GG247 | 26" |
| GG244-01 | Replacement Handle |



Squeegee Tool Handle
US Patent #D614,471S

Squeegees and Aluminum Frame

Sturdy, lightweight 24" wide aluminum squeegee frame used with a 24" wide, 2" high, EPDM squeegee blade, available in straight, V-notched, or U-notched. Used to ensure consistent depth when spreading thin materials. Used with broom thread handle. Shown with 3-piece aluminum handle (CC263). All items sold separately.

- | No. | Description |
|----------|--|
| GG235-01 | 24" Aluminum Frame ONLY (Order blades separately) |
| GG235-04 | 24" Wide Straight Blade Squeegee Replacement Blade |
| GG235-02 | 24" Wide 1/8" V-notched Squeegee Replacement Blade |
| GG235-03 | 24" Wide 1/4" V-notched Squeegee Replacement Blade |
| GG235-05 | 24" Wide 1/4" U-notched Squeegee Replacement Blade |
| CC263 | 3-Piece Aluminum Handle |

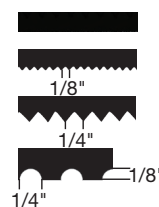

*See page 178

CONCRETE RESTORATION

Spiked Rollers

Roll out air bubbles in epoxy coatings and self-leveling material with two styles of spiked nylon rollers.

Use caution with sharp Spiked Rollers.

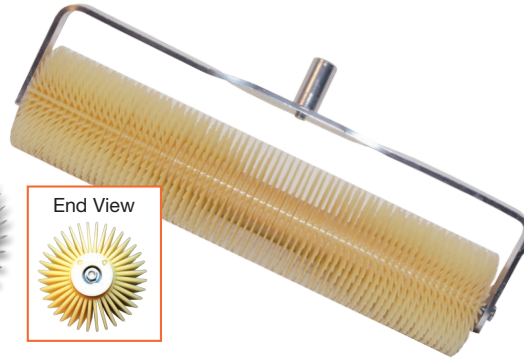
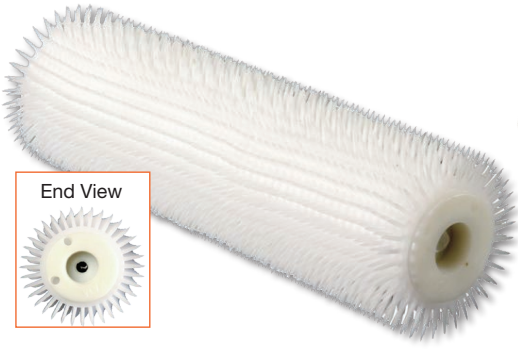
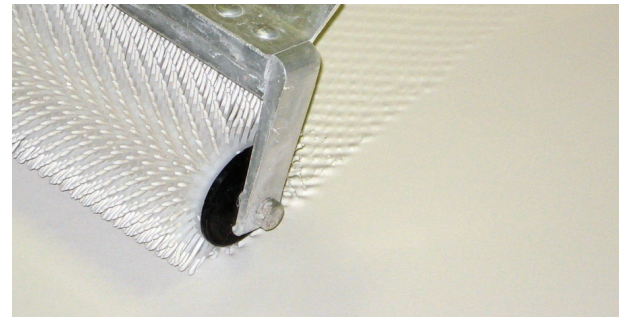

Super Spike Roller

Each spike measures 1/2" long. Super sharp spikes.

No.	Size	Description
GG476	9"	Roller with Frame
GG478	18"	Roller with Frame
GG477	9"	Super Spike Roller Only
GG479	18"	Super Spike Roller Only
DW179M*	9"	Roller Frame
DW178	18"	Roller Frame

Standard Spike Roller

Each spike measures 1-1/4" long.

No.	Size	Description
GG609	9"	Roller with Frame
GG618	18"	Roller with Frame
GG610	9"	Standard Spike Roller Only
GG619	18"	Standard Spike Roller Only
DW179M*	9"	Roller Frame
DW178	18"	Roller Frame



9" Spike Roller Frame

Aluminum frame with contoured plastic handle with thumb rest. Threaded end for use with broom thread handles (page 46).
No. DW179M*

Nap Roller Covers

Shed resistant for a smooth professional finish. Used for applying adhesives and coatings, especially for moisture vapor barrier.

Order roller frame separately.

No.	Width	Nap
DW171	9"	1/4"
DW172	9"	3/8"

(18" comes with end caps)

DW174	18"	1/4"
DW173	18"	3/8"

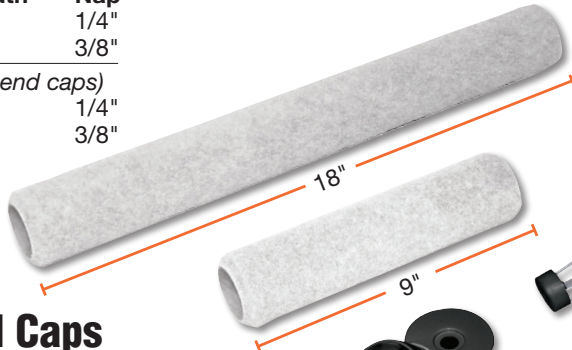

Roller End Caps

Prevent material from building up inside rollers. Comes in a pack of 6 caps.

No. DW178-02



18" Roller Frame

With Threaded Handle Adapter

18" aluminum frame securely holds standard 18" paint rollers, adhesive rollers, and spiked rollers for rolling larger areas. Full, two-sided frame applies even pressure across length of roller. Handle accepts standard broom thread handle for extended reach.

No. DW178



9" Roller Frame

9" roller frame with contoured plastic handle, threaded end for broom thread handle (page 46). Order roller covers separately.

No. DW179*

Double Notch Rake

Hardened steel blade with V-Notch for spreading floor coatings. Notched on 2 sides of rake. Includes 3-piece 60" threaded handle (CC263).

18" Double Notch Rake

No.	V-Notch Size
GG591	3/16"
GG605	1/4"
GG592	3/8"
GG593	1/2"

24" Double Notch Rake

No.	V-Notch Size
GG594	3/16"
GG606	1/4"
GG595	3/8"
GG596	1/2"



Add "01" after part no. for rake without handle

Roller Tray

Durable plastic holds roller up to 18" long.

No. DW189



Gauge Rake

Made of lightweight aluminum. Adjusts up to 2" for uniform coating of surface. Includes a 3-piece 5' aluminum broom thread handle (CC263).

No.	Description
CC975	24" Rake with Handle
CC975-01	24" Rake without Handle
CC976	36" Rake with Handle
CC976-01	36" Rake without Handle
CC975-04	Replacement Sleds & Hardware



Heavy-Duty Gunite Shoes Adjustable

Lightweight aluminum shoes, fitted with (12) 1" permanent steel spikes. Adjustable sole plate and heel support. Two adjustable nylon straps securely hold gunite shoe to work boot. One size fits most.

No. CC970 (Pair)



Flexible Gunite Shoes

Gray flexible plastic lets you work with natural movements. Protect your work and bring air bubbles out of the application. (13) firmly attached 3/4" (overall length) steel spikes cover the bottom of the shoe. Two adjustable nylon straps securely hold gunite shoe to work boot. One size fits most.

No.	Description
HC177*	Flexible Gunite Shoes (Pair)
HC177-01*	3/4" Replacement Spikes (26)
HC178-02*	Replacement Straps (Set)



Gunite Shoes

Used for epoxy installation. Fitted with (13) 1-1/2" (overall length) steel spikes. Two adjustable nylon straps with clasps securely hold gunite shoe to work boot. One size fits most.

No.	Description
HC178*	Gunite Shoes (Pair)
HC178-01*	1-1/2" Replacement Spikes (26)
HC178-02*	Replacement Straps (Set)



Oval Mixer

High viscosity mixer. Oval shape effectively removes air from mixtures. Designed to fit edges of barrels. Carbon plated steel. 26" Shaft. For use in a 1/2" drill.

No. DC717*

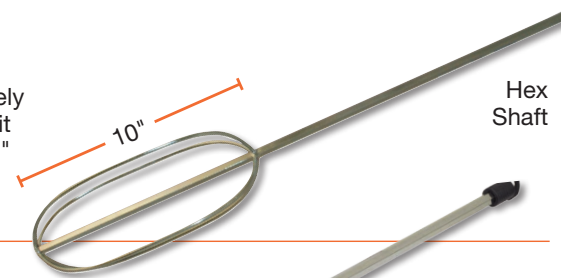

Hex Shaft

Unomixer

Ideal for fast mixing of many materials, from paint to cement. Unique design mixes materials quickly. 3-1/4" diameter spiral head is welded to 16" shaft for strength. For use in a 1/2" drill.

No. DC363*



Hex Shaft

Triangle Blade Mixer

Multi-purpose triangle blade mixer. Use with all concrete-based products. Measures 9-1/2" head depth, 23-1/4" overall. For use in a 1/2" drill.

No. DC721



Hex Shaft

Stainless Steel Jiffy Mud and Paint Mixers

For heavy-duty jobs. Fits 5-10 gallon containers. 20-1/2" long, 1/2" shaft, top diameter 4-5/8", bottom diameter 5", depth 5". Use with 1/2" drill.

No. DC409



Round Shaft

Stainless Steel Jiffy Mixer

For small containers 2 gallons or less. 10-1/4" long, 1/4" shaft, top diameter 2-5/8", bottom diameter 2-5/8", depth 2-3/8". Use with 3/8" drill at 450-750 RPMS for best results.

No. DC408



Round Shaft

Junior Mud Mixer

Rounded end design for better balance when mixing, prevents scraping of container. Ideal for mixing drywall mud and texture materials. Mud mixer has a cast aluminum paddle 8-1/2"x5" deep. 7/16" steel shaft works in slow speed 1/2" drill.

No.	Size
DC713	7/16" diam. x 30" shaft
DC714	7/16" diam. x 36" shaft
DC714L	7/16" diam. x 46" shaft

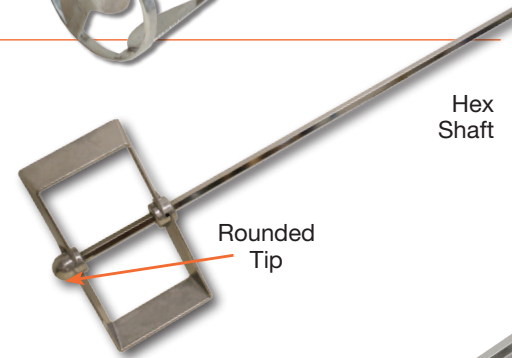

Hex Shaft

Epoxy Mixing Paddle

Flat steel blade with slots so material flows through and around mixer. Ideal for mixing epoxies, mortars, resins and other construction materials. Plated to resist wear and corrosion. 7/16" hex shaft. Overall length 18". Fits most 1/2" drill motors.

No. DC719



Hex Shaft

Double Bent Mixer

Bent mixing blades provide a bottom-to-top mixing action. Mix urethane and other materials smoothly. Plated to reduce wear and corrosion. Fits most 1/2" drill motors. 18" hex shaft. 4"x3" blades.

No. DC720



Hex Shaft

*See page 178

Rub Bricks

A) Fluted with Handle

Fluted silicon carbide rub bricks make dressing down concrete fast and easy. The fluted bricks are on a diagonal which provides sharp edges to help with stubborn materials while carrying away excess debris. Contoured plastic handle minimizes fatigue. Preferred by finishers for its ease of use.

No.	Size	Grit
CF268	8"x3-1/2"x1-1/2"	20
CF283	6"x3"x1"	20
CF282	6"x3"x1"	60

B) Fluted Less Handle

Made of silicon carbide, fluted on two sides.

No.	Size	Grit
CF462	6"x2"x2"	20
CF482	8"x2"x2"	20

Replacement Handle
for all Rub Bricks - CF283-01



Round Rub Brick

Lightweight round rub brick with handle. Makes grinding easy. Use one in each hand, in a circular motion. Stone is 1" thick and 6" diameter.

No.	Size	Grit
CF270	6"x1"	20



Broken-In Rub Brick

Already broken-in and ready for smoothing and dressing down concrete. A good value for the price.

No.	Size	Grit
CF281	8"x3-1/2"x3/4"	20



Rub Brick Mop

Fluted Rub Brick Mop used for concrete smoothing, dressing down and removing form marks. Aluminum bracket with 5' wood clevis handle (CC386).

No.	Size	Grit
CC497	8"x7"	20
CC497-01	8"x7" without Handle	20
CF268-01	Replacement Rub Brick (2 required)	20

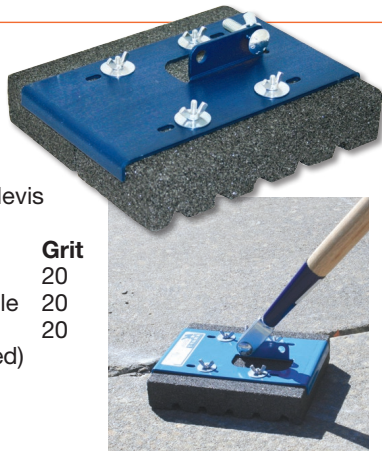

White Rub Brick Mop

Non-marring surface is ideal for decorative applications to insure a clean finish. Two fluted rub bricks are secured to a strong aluminum bracket. Includes a 5' clevis handle (CC386).

No.	Size	Grit
CC489	8"x7"	60
CC489-01	8"x7" without Handle	60
ST280-01	Replacement Rub Brick (2 required)	60



NEW

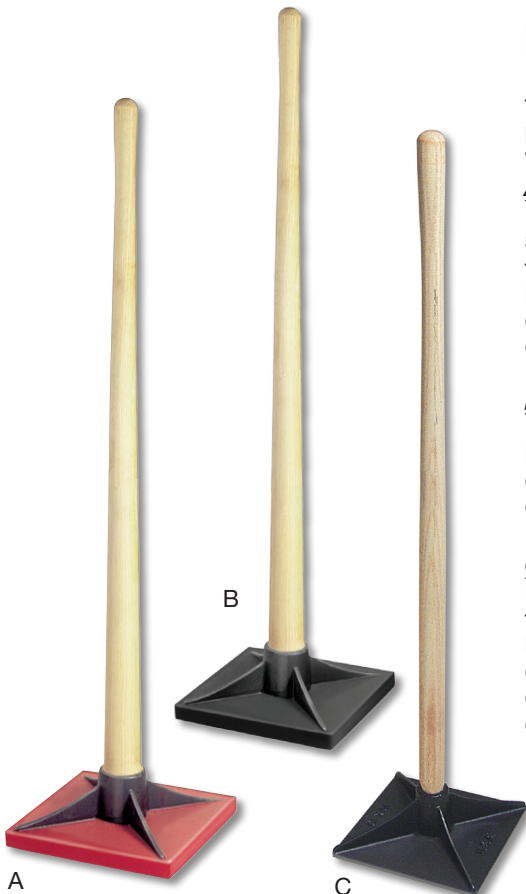

Heavy-Duty Tampers

Ideal for tamping soil, gravel, sand, and texture mats to achieve the right amount of pressure. Heavy-duty cast iron tampers fitted with 48" hardwood handle.

A) Cast Iron/Poly-Coated Base Texture Mat Tamper with Heavy-Duty Handle

Special rubber poly-coated base prevents tearing or marring of texture mats

No.	Description
CC928	11"x11" Heavy-Duty / 21 lbs.
CC928-01	Heavy-Duty Repl. Handle

B) Cast Iron Base Dirt Tamper with Heavy-Duty Handle

No.	Description
CC929	10"x10" Heavy-Duty / 17 lbs.
CC928-01	Heavy-Duty Repl. Handle

C) Cast Iron Base Dirt Tamper

Excellent way to tamp dirt surfaces. Cast iron tamper fitted with a 44" hardwood handle.

No.	Description
CC925	8"x8" / 12 lbs.
CC926	10"x10" / 13 lbs.
CC927	Replacement Handle

Landscape/Floor Scraper

A great all-purpose scraper. The 7" long forged head provides the strength needed for scraping hard material off of roadways, roofs, and other surfaces. The strong blade is great for breaking up ice in the wintertime. A secure ferrule mounting attaches the 54" hardwood handle. The strength of this scraper makes it a popular choice in landscaping for cutting roots, digging, and edging. Overall length 63".

No. GG859*



NEW

Concrete Roller Tamps

- 5" roller diameter
- Depresses the aggregate and brings the fat to the surface in a uniform manner
- Levels the slab in half the time and does a better job than other conventional tampers
- Prepares the surface for a smoother finish
- Rollers fit either threaded or button extension handles (sold separately, pages 22-23)

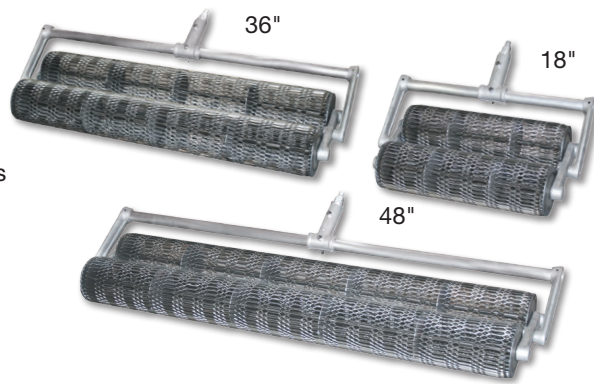

Special Roller Tamp Screen



Double Roller Tamps - 2 rollers per tamp head

Uses Threaded Bull Float Handles

No.	Size
CC948	18"
CC952	36"
CC958	48"



Uses 1-3/8" Button End Handles

No.	Size
CC948A	18"
CC952A	36"
CC958A	48"



Uses 1-3/4" Button End Handles

No.	Size
CC948B	18"
CC952B	36"
CC958B	48"



Replacement Roller with Shaft

No.	Size
CC949	18"
CC954	36"
CC959	48"

Single Roller Tamps - 1 roller per tamp head

Uses Threaded Bull Float Handles

No.	Size
CC952SINGLE	36"



Uses 1-3/8" Button End Handles

No.	Size
CC952ASINGLE	36"



Uses 1-3/4" Button End Handles

No.	Size
CC952BSINGLE	36"



Extension Handles
See Pages 22-23



Replacement Handle
No. CC883



Can ship UPS

Concrete Tamper

Rugged and durable concrete tampers are built to handle any job. Tamping pushes large aggregate to the bottom of the cement to add strength; fat rises to the top for easy finishing. Balanced for ease in use. Welded support bar between the handles for stability. Contoured handles with a slight texture provides a firm grip.

Round Hole Grill Pattern

No.	Size
CC887	36"x8" Unassembled
CC887ASM**	36"x8" Assembled
CC885	48"x8" Unassembled
CC885ASM**	48"x8" Assembled

Big Diamond Grill Pattern

Many concrete finishers prefer this style because it diverts the concrete splash away from the legs of the finisher.

No.	Size
CC879	36"x8" Unassembled
CC879ASM**	36"x8" Assembled
CC881	48"x8" Unassembled
CC881ASM**	48"x8" Assembled

**Must ship via truck

Economy Concrete Tamper

Durable concrete tampers are built to handle any job. Tamping with this tool pushes large aggregate to the bottom of the cement to add strength; fat rises to the top for easy finishing. Balanced for ease in use with support bar. Hardware included. Ships flat, unassembled.

No.	Size	Grill Pattern
CC887E*	36"x8"	Round Hole
CC885E*	48"x8"	Round Hole
CC879E*	36"x8"	Diamond
CC881E*	48"x8"	Diamond

Safety Roller

Diamond Patterned Safety Roller gives a rough, skid resistant finish to concrete ramps. Perfect for wheelchair or loading walkways where a non-skid surface is a must. Roller is 5" in diameter. Roller is made of tough expanded steel diamond mesh. Handle bracket accepts threaded 1-3/4" threaded bull float extension handles.

No.	Roller Size
CC956-24	24"
CC956-36	36"

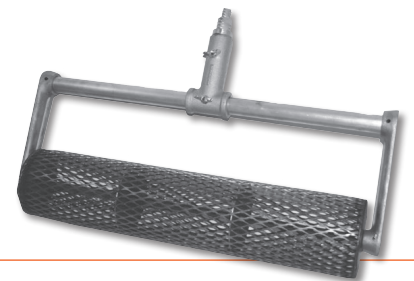

8" Roller Tamp

Prepares the slab the same way as other roller tamps. Works great in small areas, steps, or close to buildings and walls. Special handle angle keeps the finisher from scraping against buildings, forms or walls. Use with 1-3/8" swaged button handle or adapter (sold separately, pages 22-24).

No.	Description
CC946	8"x5" Diameter Roller with 1-3/8" Button Handle Adapter



*See page 178

Foam Rubber Knee Pads

Professional foam rubber hard shell knee pads. Contoured cap provides extra support and comfort for heavy use. Velcro® closures are easy to adjust and use.

No. WL135 (Pair)

Non-Skid Knee Pads (not shown)

Same as above. Rubber cap prevents sliding and marring of surfaces.

No. WL136 (Pair)



Rubber Cushion Knee Pads

A rubber cushion knee pad on the inside with a solid rubber surface for rugged long wear. Adjustable web straps with Velcro® closures are embedded within the pad.

(Judson Knee Pads)
No. WL070 (Pair)



Leather Knee Pads

Tough leather makes for long wear. Lined with felt and shaped to fit your knee. Rivet construction holds soft felt in place. One adjustable strap holds pad securely in place.

No. Description

WL087 1/2" Thick Felt (Pair)

WL088 1" Thick Double Felt (Pair)



Flat Leather Knee Pads

Hard but pliable, comfortable leather knee pads, lined with soft felt that bends with the knee. One adjustable strap holds pad in place while you work.

No. WL071 (Pair)



Knee Pads

Super Soft / Front Closure

- Protect knees with soft neoprene pad
- Unique, easy to use front Velcro® strap
- Wide binding straps will not gouge
- Coated with non-marring polyurethane for added protection and durability

No. WL139* (Pair)



Hinge Style Knee Pads

- Hinge style
- Extra cushion back with hard shell cap
- Wide nylon Velcro® straps for extra comfort

No. WL137 (Pair)



Polyurethane Knee Pads

- Made of shock-absorbing and durable polyurethane
- One strap holds the pad in place
- Pads are molded in one piece
- Very popular with concrete finishers

No. WL083 (Pair)



Ultra Rubber Knee Pads

- Durable rubber with comfortable foam pad insert
- Adjustable replaceable straps
- Accordion style cap

No. Description

WL084* Knee Pads (Pair)

WL084-01 Replacement Straps



Economy Soft Cap Knee Pads

- Long, contoured flexible cap provides a protective base
- Foam rubber cushion offers a soft protection for knees
- Velcro® closures are easy to adjust

No. WL136E* (Pair)



Polyurethane Knee Pads

- Made of durable lightweight polyurethane
- Used for all types of construction projects
- Two web straps hold pads to knees
- Pads are molded in one piece

No. Description

WL080 Knee Pads (Pair)

WL082 Replacement Straps (Pair)



Denver Sliders

Made with top quality #16 gauge stainless steel for an extra smooth sliding surface. Round edges and corners with special nesting design. Built-in toe brackets for easy back-and-forth motion. Weight 11 lbs.

No. CC152 **Size** 28"x8-1/2" (Pair)

Special nesting design



Concrete Sliders (Knee Boards)

Made of lightweight, tough heavy-duty polystyrene plastic that resists corrosion. Easy to use, easy to clean. One size fits most. Knee pads are replaceable.

No. CC153 **Description** 30"x10" (Pair)
 WL080 Replacement Pads (Pair)
 WL082 Replacement Straps (Pair)



Lightweight Stainless Steel Knee Boards

Knee boards are made of #18 gauge stainless steel. They are durable and easy to use. Knee pads are replaceable.

No. CC162 **Size** 28"x8" (Pair)
 WL080 Replacement Pads (Pair)
 WL082 Replacement Straps (Pair)



#18 Gauge

Deluxe Heavy-Duty Stainless Steel Knee Boards

Made with #16 gauge polished stainless steel to reduce corrosive problems. Reinforced and contoured on the bottom to prevent digging into the concrete. Adjustable knee pads are replaceable and allow a "comfort fit."

No. CC150 **Size** 31"x8" (Pair)
 CC151 28"x8" (Pair)
 WL080 Replacement Pads (Pair)
 WL082 Replacement Straps (Pair)



Heavy-Duty #16 Gauge

EZ-Kneeler™ Kneeboard

*Comfortable
Multi-Purpose
Kneeboard*

- Washable and chemical resistant
- Weighs only 2 lbs.
- 1-1/2" thick foam cushion
- Made in the USA

Provides the knees comfortable support and protection - *no more sore knees!* A 1-1/2" thick foam cushion (working surface measures 19-1/4"x13-1/2") securely fastened to 14"x24" polypropylene tray for maximum comfort and long life. It is a favorite of concrete finishers and tile installers.

No. WL069 (10) Per carton



Ideal For:
 Concrete Finishing
 Laying Tile and Carpet
 Plumbing and Electrical
 Lawn and Garden
 Auto Repair
 And More!

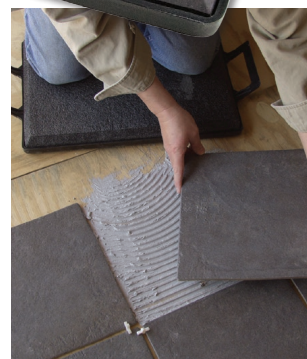

Case Cut Boxes
Ready to Display

ASPHALT LUTES & RAKES

GENUINE EXTRU-LITE™
MAGNESIUM



Magnesium Asphalt Lute With T-Lute Bracket

- Heavy-duty magnesium construction for longevity and strength
- Aluminum T-lute bracket for strength
- Ensures asphalt is applied evenly
- Use smooth side for finishing
- Handles are 1-3/8" in diameter
- Ships unassembled

Standard Teeth Lute

No.	Head Size	Handle
GG824-6	24"	6'
GG824	24"	7'
GG824-9	24"	9'
GG830-6	30"	6'
GG830	30"	7'
GG830-9	30"	9'
GG836-6	36"	6'
GG836	36"	7'
GG836-9	36"	9'
GG842-6	42"	6'
GG842	42"	7'
GG842-9	42"	9'

Flat Teeth Lute

No.	Head Size	Handle
GG824F-6	24"	6'
GG824F	24"	7'
GG824F-9	24"	9'
GG830F-6	30"	6'
GG830F	30"	7'
GG830F-9	30"	9'
GG836F-6	36"	6'
GG836F	36"	7'
GG836F-9	36"	9'
GG842F-6	42"	6'
GG842F	42"	7'
GG842F-9	42"	9'

NO Teeth Lute

No.	Head Size	Handle
GG830N	30"	7'
GG836N	36"	7'

Add "01" after part no. for blade only

Magnesium Asphalt Placer Lute With Round to Square Wood Handle

A must-have in this industry. Heavy-duty blade 30" made from 100% Genuine Extru-Lite™ Magnesium. The round to square 66" wood handle not only adds comfort but gives the end user a great grip. Ships unassembled.

No.	Description
GG875	Asphalt Placer Lute
GG875-01	Replacement Blade
GG875-02	Replacement Bracket
GG875-03	66" Replacement Handle

Right Angle Blade



Landscape and Asphalt Rake

This rake's 36" aluminum head is made for rugged use on asphalt and other tough materials. The 2-1/2" teeth have ball tips to ensure longer life. The 7'x1-3/8" magnesium is handle attached to a lightweight bracket (GG824-03). Ships unassembled.

No.	Size
CC960	36"
GG824-02	7' Replacement Handle



Magnesium Asphalt Rake

Lightweight magnesium head features standard teeth on one side and a smooth edge on the other. Includes 7'x1-3/8" blue anodized aluminum handle, which prevents hands from turning black caused by oxidation. Foam grip protects end of handle. Fitted with braces for extra support. Ships unassembled.

No.	Size
GG624	24" Rake Head
GG625	30" Rake Head
GG626	36" Rake Head
GG627	42" Rake Head
GG626-03	7' Blue Aluminum Handle

GENUINE EXTRU-LITE™
MAGNESIUM



Forged Bow Rake

The versatile forged steel Bow Rake can be used for tough landscaping jobs or roadwork. Made from one piece forged tempered steel, it features 16 curved 2-5/8" teeth across the 16-1/4" wide rake head. Two rivet construction connects the ferrule all the way through the 60" ashwood handle for extra strength and durability. Ideal for breaking up compacted soil, spreading materials evenly, raking leaves, grass, or moving asphalt material, heavy stones and gravel. A great rake for professional contractors and homeowners.

No. GG874

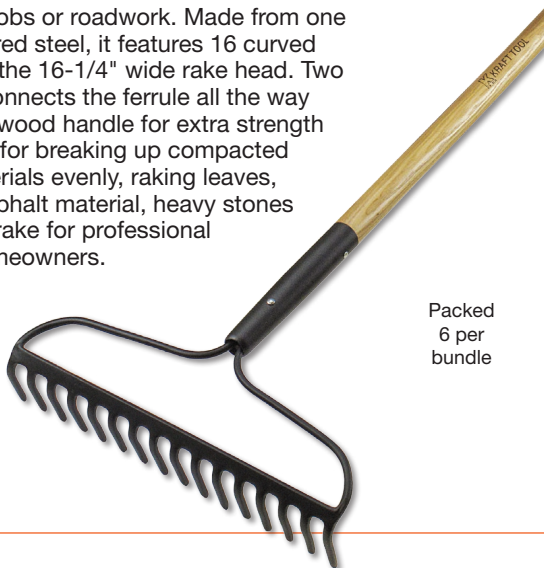

Packed
6 per
bundle

Landscape Rake

This rake's 36" aluminum head is made for rugged use on rocks, gravel, mulch, and other landscaping material. The 2-1/2" teeth have ball tips to endure a long life. The straight teeth are great for raking through both landscape and asphalt materials. After raking, flip over the blade to smooth the material for a professional look. Heavy-duty braces support the head. The 7' handle is anodized to protect the metal and prevent the user's hands from turning black from oxidation. The bright blue handle is easy to spot on the jobsite. The 1-3/8" diameter handle is easy to grasp. Ships unassembled.

No. GG959



Heavy-Duty Road Rake

14 Forged Teeth

A versatile rake for road work or heavy-duty landscaping. The forged steel head features 14 teeth across 16". The 3-1/2" long teeth provide support when moving stones, gravel and asphalt material. An 8" ferrule secures the 60" hardwood handle to the rake head.

No. GG871



Packed
6 per
bundle

Steel Asphalt Rake

Long 18" Shank

Heavy-duty construction, designed for tough use in asphalt paving. The 16" wide head features 14 teeth that extend down 3-1/4" to move through material. 18" long shank provides extra reach to burn asphalt build up. Sturdy wood handle is 60" long. Entire length of the tool is 78".

No. GG870



Packed
6 per
bundle

Asphalt Trowel

Use the right angle edge like a shovel to apply filler material into cracks. Steel blade tamps down the material and edge helps smooth surfaces.

No. HC249PF*

Order in cartons
of 6 each



Asphalt Shoes

Walk on asphalt in comfort without harming the surface.

Use to tamp down the surface in hard to reach areas. 1/2" felt protects the user and the surface. Each shoe has a galvanized steel base with a heel base to secure the user's foot for stability. Two adjustable nylon straps fit around the ankle and top of foot. One size fits most.

No. GG811



Professional Asphalt Mahogany I-Beam Level

Designed to be used in asphalt construction - NO plastic parts. Made from the finest selection of mahogany wood.

No.	Length	Vials
SLAL48	48" (1219mm)	2



- Heavy-duty aluminum I-beam for reinforced strength
- Two top-reading Solid Set Cat's Eye Yellow double bent vials for accuracy
- Protective glass lenses
- Two large hand holes and one hang hole

*See page 178

SQUEEGEES

Pull Style
GG817

Push Style
GG816

Permanent Head Crack Squeegees

V-shaped head is welded into a fixed position for your choice of either push or pull action. V-shape funnels hot or cold crack filler. Red silicone blade withstands temperatures up to 450°F. Attached to a 54" heavy-duty wood handle.

No.	Description
GG816	Push Style V-Shaped Squeegee
GG817	Pull Style V-Shaped Squeegee
GG814-02	V-Shape Red Silicone Replacement Blade

Asphalt Seal Coating Squeegees

Rounded end blade allows a thin layer of material to be placed on the surface. Square end blade cleans working surface and can apply sealant. Both styles feature a Neoprene 60 G blade that withstands temperatures up to 220°F and is clamped to aluminum head for an easy change or reversal of blade. Blade angle designed for easy working angle and quick break-in period.

Round Edge Asphalt Seal Coating Squeegee

No.	Size	Handle
GG844RE	24" Squeegee	7'
GG844RE-6	24" Squeegee	6'
GG844RE-01	24" Replacement Blade	
GG845RE	36" Squeegee	7'
GG845RE-6	36" Squeegee	6'
GG845RE-01	36" Replacement Blade	
GG846RE	48" Squeegee	7'
GG846RE-6	48" Squeegee	6'
GG846RE-01	48" Replacement Blade	

Square Edge Asphalt Seal Coating Squeegee

No.	Size	Handle
GG844	24" Squeegee	7'
GG844-01	24" Replacement Blade	
GG845	36" Squeegee	7'
GG845-01	36" Replacement Blade	
GG846	48" Squeegee	7'
GG846-01	48" Replacement Blade	

Round
Edge



Side
View

Square
Edge



Side
View

Reversible Head Crack Squeegees

Reversible head allows a push or pull action to funnel material into cracks. Choose between V or U-shaped black Neoprene blade that withstands temperatures up to 220°F. V-shaped red silicone blade withstands temperatures up to 450°F. Each includes a 54" heavy-duty wood handle. Blades are reversible.

A) V-Shaped Black Neoprene

No.	Description
GG813	V-Shaped Black Neoprene Blade w/ 54" Clevis Handle
GG813-01	V-Shape Head and Black Neoprene Blade
GG813-02	V-shape Black Neoprene Replacement Blade
CC656	54" Handle

B) V-Shaped Red Silicone

GG814	V-Shape Reversible Red Silicone Blade w/ 54" Handle
GG814-01	V-Shape Reversible Head and Red Silicone Blade
GG814-02	V-Shape Red Silicone Replacement Blade
GG814-03	54" Handle, Without Pin

C) U-Shaped Black Neoprene

GG815	U-Shape Black Neoprene Blade w/ 54" Handle
GG815-01	U-Shape Reversible Head and Black Neoprene Blade
GG815-02	U-Shape Black Neoprene Replacement Blade
GG814-03	54" Handle, Without Pin

A
V-Shaped
GG813

B
V-Shaped
GG814

C
U-Shaped
GG815

ASPHALT TOOLS



All Steel Tamper

One piece heavy-duty steel pipe construction with welded gussets for increased strength. Designed for professional rugged use. Base is used to flatten asphalt and other materials. Stands 48" tall with rubber grip for comfort.

No.	Size
CC921	8"x8"
CC939	10"x10"

46" Junior Mud Mixer

Rounded end design for better balance when mixing. Extra long shaft for mixing in large containers. Mud mixer has a cast aluminum paddle 8-1/2"x5" deep. 7/16" steel hex shaft works in slow speed 1/2" drill.

No.	Size
DC714L	46" Shaft x 7/16" Diameter

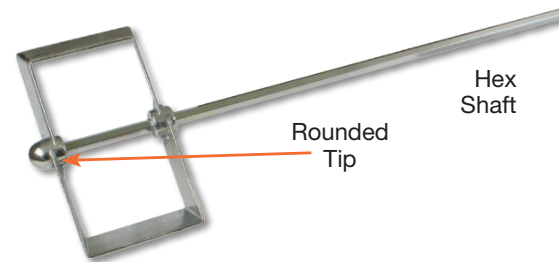

Asphalt Crack Hoe

Cleans asphalt cracks before sealing. V-shaped 2"x4" steel head. Comes with 5' wood handle attached to head.

No. GG812

Pour Pot

This 2.5 gallon, heavy gauge steel pour pot is an easy way to fill asphalt cracks with hot or cold crack filler. The convenient stand up design is available with or without wheels. Easy-to-use adjustable 3-size pouring nozzle with fingertip control top valve (squeeze to open, release to close).

No.	Description
GG961*	Pour Pot
GG961-01*	Pour Pot with Wheel Kit
GG961-02*	Wheel Kit ONLY



Asphalt Banding Machine

60% larger than a pour pot

Creates a consistent 3" wide band over cracks. Pull back on the machine to use. Holds 4 gallons of hot or cold crack sealant. Reversible wear plate extends life before replacement.

No.	Description
GG966*	Asphalt Bander
GG966-01*	Repl. Wear Plate
GG966-02*	Repl. Wheels (pair)



Seal Coat Brush

An aluminum bracket secures the 2-1/4" black poly trim for applying asphalt sealcoating and other materials. The stiff, crimped bristles provide a slight texture, ideal on most asphalt jobs. Thumbscrews allow a quick change of the broom strip for new jobs. The handle bracket accepts broom thread handles (sold separately, page 86). Kraft's 60" vinyl-coated steel handle is recommended (GG232).

No.	Description
GG847	24" Brush
GG848	36" Brush
GG849	48" Brush
GG847-01	24" Replacement Brush Strip
GG848-01	36" Replacement Brush Strip
GG849-01	48" Replacement Brush Strip
GG847-02	Replacement Seal Coat Brush Holder and Bracket (fits all sizes)
GG232	60" Heavy-Duty Coated Steel Broom Handle
CC163L	6' Metal Thread Wood Broom Handle

More broom threaded handles on page 86
For bull float adapters and handles see pages 22-24

Round Wire Street Broom

3-3/4" Coated steel wire bristles make this broom a perfect asphalt clean up tool. Great for rough spots. Comes with 54" tapered end wood handle (BL432).

No.	Description
GG877	16" Round Wire Street Broom with Handle
GG877-01	Head ONLY
BL432	54" Tapered Handle
CC107L	72" Wide Diameter (1-1/8") Tapered Wood Handle



Ammo Chalk Line Box

Heavy-duty 150' chalk line. Holds 1-1/2 lbs of chalk. Moisture-resistant easy refill lid. Great for paving contractors and highway departments. Chalk sold separately (see page 88 for all chalk).

No.	Description
GG302	Ammo Chalk Line Box
GG302-01	150' Replacement Line
GG317-48	Yellow Chalk 48 lbs.



*See page 178

Silverback™

PROFESSIONAL SERIES



- 14 gauge tempered steel blades for superior strength
- Forward turn step for comfort and firmer footing
- Lacquered hardwood handles are double riveted
- Wood and fiberglass handles available

Scoops

Long Handle Aluminum Scoop is sold 6 per bundle, other scoops sold 3 per bundle only.

No.	Description	Handle Type
A GG873*	#2 Aluminum Scoop	48" Wood
B GG869*	#12 Aluminum Scoop	28" "D" Wood
C GG868*	Asphalt Scoop	31" "D" Wood

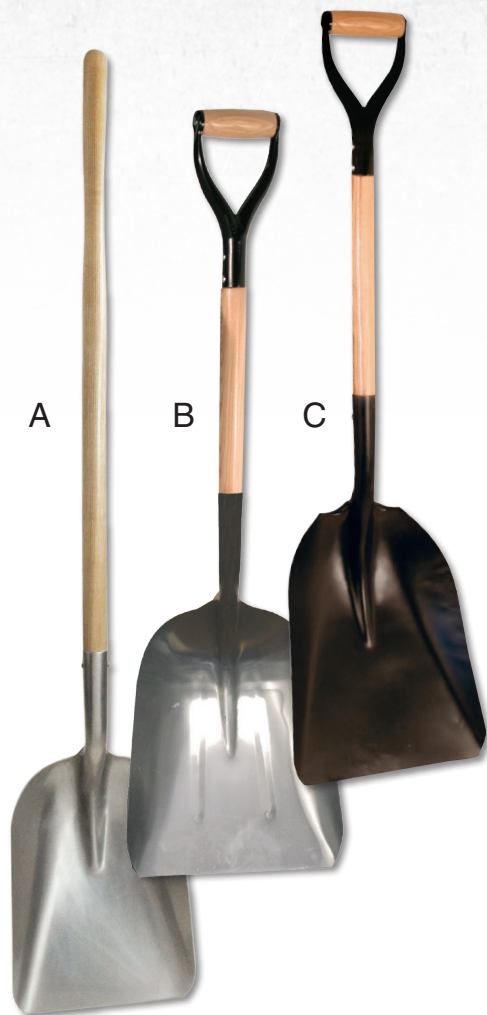

Short Handle Shovels

No.	Description	Handle Type	Sold Per Bundle Only
D GG860*	Square Point Shovel	31" "D" Wood	6 Per Bundle
E GG863*	Round Point Shovel	31" "D" Wood	6 Per Bundle
F GG866*	Round Blade Drain Spade	31" "D" Wood	6 Per Bundle
G GG867*	Square Blade Drain Spade	31" "D" Wood	6 Per Bundle

Long Handle Shovels

No.	Description	Handle	Sold Per Bundle Only
H GG861*	Square Point Shovel	48" Wood	6 Per Bundle
I GG861F*	Square Point Shovel	48" Fiberglass	6 Per Bundle
J GG864*	Round Point Shovel	48" Wood	6 Per Bundle
K GG864F*	Round Point Shovel	48" Fiberglass	6 Per Bundle
L GG866L*	Round Blade Drain Spade	48" Wood	6 Per Bundle



Fully-Stocked Retail Shovel Display

Compact metal display comes stocked with an assortment of 36 long and short handle shovels total. To see the complete list of tools, see page 172.

No.	Description
GG900*	Shovel Display with 36 Shovels

SCRAPERS & SQUEEGEES

Floor/Form Scraper

Cleans and shaves all types of material from concrete and wood surfaces. Great for concrete form cleaning. Fitted with 54" metal handle. 36" and 48" scraper comes with handle braces for extra support.

No.	Size
GG013	7" Scraper
GG013-01	7" Blade Only
GG014	14" Scraper
GG014-01	14" Blade Only
GG018	18" Scraper
GG018-01	18" Blade Only
GG022	22" Scraper
GG022-01	22" Blade Only
GG023	36" Scraper with Braces
GG023-01	36" Blade with Support
GG024	48" Scraper with Braces
GG024-01	48" Blade with Support
GG014-04	54" Repl Handle with Handle Clamp Bracket (for all Floor/Form Scrapers)

Big Floor Scraper Telescoping Handle

Features an 8" wide heavy-duty replaceable blade, and a twist-lock adjustable telescoping handle. Handle length adjusts from 36" to 59". The perfect tool for floor preparation.

No.	Description
FC506	Big Floor Scraper
FC507	(5) 8" Replacement Blades

Heavy-Duty Rubber Floor Squeegee

Rugged heavy-duty floor squeegee with all steel construction. Pure gum rubber blade is replaceable and reversible for longer wear. Comes complete with 60" wood handle and ferrule (CC901-02). Ships unassembled.

No.	Description
GG285	24" Rubber Floor Squeegee
GG286	36" Rubber Floor Squeegee
GG287	24" Rubber Refill
GG288	36" Rubber Refill

Heavy-Duty Floor Scraper

Ideal for after work clean up. Scraper blades are firm but flexible. Comes with heavy-duty 5' shovel-type wood handle.

No.	Size
CC214	Floor Scraper w/14" Blade
CC218	Floor Scraper w/18" Blade
CC222	Floor Scraper w/22" Blade
CC207	14" Blade (for CC214 only)
CC208	18" Blade (for CC218 only)
CC209	22" Blade (for CC222 only)
XHDW04	Wood Replacement Handle

T-Handle Floor Scraper

54" long all steel floor scraper. All steel "T" handle with weighted head for extra leverage. Shaves all kinds of floor coverings on any type of floor. Fitted with 7" or 10" replaceable steel blade.

No.	Size
GG393	Floor Scraper w/7" Blade
GG397	Floor Scraper w/10" Blade
GG394	7" Replacement Blade
GG395	10" Replacement Blade

Right Angle Scraper

18" scraper with 60" aluminum cushion grip handle. Right angle bracket gives extra strength. Heavy gauge, replaceable steel blade. Perfect clean up tool.

No.	Size
GG012	18" Right Angle Scraper
GG018-01	18" Replacement Blade

Squeegees

All Neoprene squeegee blades come with metal head and aluminum bracket. Requires a broom thread handle (sold separately).

Straight Blade Squeegee

Blade, head and bracket only

No.	Size
GG223-01	18"
GG224-01	24"
GG236-01	36"

Curved Blade Squeegee

Blade, head and bracket only

No.	Size
GG224C-01	24"
GG236C-01	36"

Squeegee Replacement Blades

No.	Size
GG223-03	18"
GG224-03	24"
GG236-03	36"

GG232	60" Threaded Coated Steel Handle
CC163	60" Threaded Wood Handle
CC163L	72" Threaded Wood Handle
GG224-04*	Replacement Handle Bracket



Heavy-Duty Floor Scraper



T-Handle Floor Scraper



Right Angle Scraper



90° Angle



Shown with GG232 Handle

*See page 178

Heavy-Duty Broom

Designed for heavy sweeping. Heavy-duty 5-3/4" crimped orange poly bristles. Bristles hold up under the toughest of conditions. Comes with 54" tapered end wood handle (BL432). Also works with threaded broom handles.

No.	Size	Add (01) to Part No. for Head Only
CC264	16" Broom	
CC195	18" Broom	
CC197	24" Broom	
CC195-02	Broom Bracket	
CC107L	1-1/8" diam. 72" Tapered Handle	



Must order Bracket Separately



Squeegee Coater Brush

18" hardwood block includes squeegee, brush and handle hole. Two rows of 2" palmyra bristles permits even distribution of coatings and asphalt sealers. Squeegee creates a smooth professional finish. Comes with 60" threaded handle (CC163).

No. GG876



Add (01) to Part No. for Head Only

3 Knot Brush

4-1/4" long durable bristles resist acids - ideal for applying roof sealants. Rounded design provides better coverage around pipes and other obstructions. Use with threaded broom handles (sold separately).

No. BL501



Economy Coating / Cleaning Brush

Perfect for applying coatings, rough scrubbing or acid cleaning. Smooth wood block with 9-1/2" brush surface and 2" tampico fibers. Use with threaded broom handles (sold separately).

No. BL503



Broom Handles

Telescoping Fiberglass® Handles

These handles fit all brooms that take a broom thread. Swivel twist lock loosens and tightens handles when extended to desired length.

No.	Size
A) CC446	Fiberglass® with Aluminum Extensions 6'3" to 12'
B) CC429	Fiberglass® with Aluminum Extensions 6'6" to 18'
C) CC448	All Fiberglass® 6'3" to 12'

Wood Handles

No.	Size
D) CC163	60" Metal Thread Wood Broom Handle
E) CC163L	72" Metal Thread Wood Broom Handle
F) CC107	54" Wide Diameter (1-1/8") Tapered Wood Jam Handle
CC107L	72" Wide Diameter (1-1/8") Tapered Wood Jam Handle
BL432	54" Tapered Wood Jam Handle (<i>not shown</i>)
G) BL431	14" Tapered Wood Jam Handle

Steel Handle

Heavy-duty coated steel handle with broom thread tip.

No.	Size
H) GG232	60" Coated Steel Handle

3-Piece Aluminum Handle

3-piece snap-style handle with broom thread tip.

No.	Size
I) CC263	60" Anodized Aluminum Handle

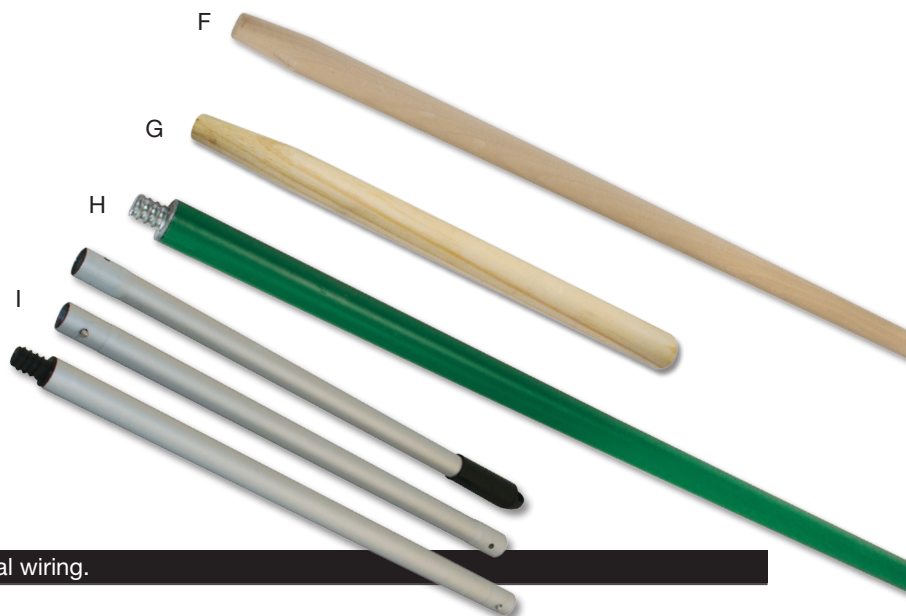
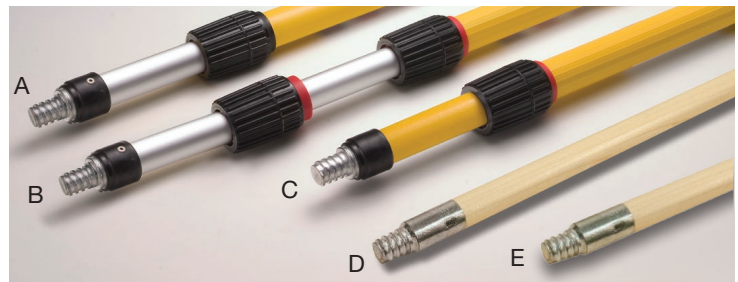

Handle Adapters

Page 44

CAUTION: Metal handles/adapters should not be used near electrical wiring.

Proudly Made In The USA

General Purpose Hammer

20 oz. curved claw general purpose hammer with smooth face. 11" wood handle.
No. GG219



Framing Hammer

21 oz. Fiberglass handle with a comfortable grip and your choice of a smooth or milled face on this must-have framing hammer.

No.	Style
GG641*	Smooth Face
GG642*	Milled Face



Estwing® 16" All Steel Framing Hammer

Drive nails straight and fast with this powerful steel hammer. Nylon vinyl grip.

No.	Weight	Face
GG417	22 oz.	Milled
GGE316S	16 oz.	Smooth



Sledge Hammers

Double faced sledge hammer available in two sizes. Choice of fiberglass or wood handles. Fiberglass handle has rubber grip for strong hold. Replaceable 32" wood handle with wedges available.

Fiberglass Handle

No.	Size
GG638F*	8 lb.
GG640F*	10 lb.

Wood Handle

No.	Size
GG638*	8 lb.
GG640*	10 lb.
GG638-01*	Replacement Wood Handle with Wedges



Sledge Hammer With Fiberglass Handle

4 lb. sledge style head with strong fiberglass handle with rubber grips. Overall length 15-1/2". Ideal for working with forms, stakes and other general construction jobs.

No.	Weight
BL454F*	4 lbs.



Mash Hammer

Forged steel head. Comes with 8-1/4" wood or fiberglass handle. Used by the professional bricklayer.

No.	Weight
BL453*	3 lbs. Wood Handle
BL453F*	3 lbs. Fiberglass Handle



Estwing® One-Piece Mash Hammer

Made of steel with nylon-vinyl cushion grip. Polished face and bevel, painted finish.

No.	Weight
BL352	2 lbs.
BL353	3 lbs.
BL354	4 lbs.



Dead Blow Hammer

2 pound hammer packs a wallop, yet dampens the vibration when striking the surface and minimizes the rebound. Compact head is flared for full coverage. The extruded handle is secured to tool. A rubber cover eliminates the possibility of sparking when striking metal, and minimizes surface marring.

No.	Weight
BL275*	2 lbs.



Drywall Hammers

Heavy-Duty

Chrome plated head features a checkered face to make nailing easier and prevents breaking the surface of wallboard. The 1-3/4" blade scores drywall for rough cut openings. The axe blade also has a puller notch for nails. Head is securely attached to a wood handle for perfect balance.

No.	Description
DW254	18 oz. Head / 14" Handle
DW264	18 oz. Head / 16" Handle

Lightweight

Beautifully balanced chrome head has a crowned checkered face to make nailing easy. The lightweight yet durable head is securely attached to a wood handle for a perfect balance.

No.	Description
DW354	13 oz. Head / 14" Handle
DW364	13 oz. Head / 16" Handle



*See page 178

CONTRACTOR BASICS



Ammo Chalk Line Box

Heavy-duty 150' chalk line. Holds 1-1/2 lbs. of chalk. Moisture resistant easy refill lid. Great for paving contractors, highway departments and landscape contractors. Order chalk separately.

No.	Description
GG302	Ammo Chalk Line Box
GG302-01	150' Replacement Line



100' Chalk Box With Line Level

A retractable line level provides versatility to this 100' chalk box. The line level is attached to the line so it can't get lost. The end hook dock can tack into drywall or hooks on nails. Easy chalk refill minimizes waste. Comfortable grip fits in hand.

Hang hole for easy storage. Order chalk separately.

No. GG337*

Large 150' Chalk Box Heavy Duty

This heavy-duty chalk box features 150' of line. The sturdy line has a pull ring for easy pull and hooks onto nails to snap the line. The durable plastic container is easy-to-fill. It holds over a pound of chalk so you spend less time refilling. A solid single piece steel handle ensures a long life to this tool.

Order chalk separately.

No. GG335



DIY Caulk Gun

Lightweight, easy-to-load gun with spout cutter and puncture tool. Accommodates standard 10 oz. caulk cartridge.

No. GG278*



Pro Caulk Gun

Professional caulking gun features all steel construction. Easy-to-load barrel swivels to quickly change the angles on corners. Ladder hook keeps the tools handy on the jobsite.

No.	Description
GG279*	10 oz.
GG277*	1 qt.



Chalk Box

Use either as a chalk line or plumb line. Comes with 100' line. Order chalk separately.

No. GG319



Sold 6
Per Box

4' Caulk Gun

Extra Long Reaching

Long reach to caulk floors without stooping, or ceilings without stretching or ladders. Anodized aluminum orange gun won't turn hands black from use. Cut the plastic top to desired diameter for tip. Includes plunger and replaceable tip for use with tubes of caulk. Set up for use with sausage packs of caulking and fireproofing. Remove tip and plastic plug for use with tubes of caulk.

No.	Description
GG276*	Caulk Gun
GG276-01*	Replacement Tip for Caulk Gun
GG276-02*	Replacement Sausage Tip Pack for Caulk Gun



Chalk

High quality chalk for use in any chalk box.

No.	Color	Weight
GG303	White	8 oz.
GG304	Blue	8 oz.
GG305	Glo-Orange	8 oz.
GG306	Red	8 oz.
GG307	Yellow	8 oz.
GG221	White	5 lbs.
GG314	Blue	5 lbs.
GG315	Glo-Orange	5 lbs.
GG316	Red	5 lbs.
GG317	Yellow	5 lbs.
GG317-48	Yellow	48 lbs.



Contractor Carpenter Pencils

Flat style will not roll. Easy to sharpen.

No.	Description
SL450	Carded (2 per)
SL450B	Bulk Pack 72 (not carded)

MEASURING TAPES



Lufkin® Power Tape

Easy-to-read black markings on yellow steel tape. Stud markings at 16". Strong 4 rivet construction. Top quality durable plastic case with handy belt clip.

No. **Size**
GG294* 25'x1" Engineer's Scale
(1/16", feet, 10ths, 100ths)



25' Lufkin® Tape with Wide Thumb Lock

- 4 rivet for durability
- 16" markings for studs
- Texture strip for increased grip
- Orange stripe on mirror-finish chrome case is easy to spot
- 1" wide tape with 8' standout
- Extra-wide thumb lock for comfort
- Nylon coated blade for legibility

No. **Size**
GG338* 25'x1"

Kraft Pro Self Locking 25' Tape Measure

English/Metric



Self-locking tape offers brake releases on top and bottom of tape for personal preference. Blade printed with English and Metric on both sides for ease in reading from all angles. Durable, nylon coated blade resists fading and warping. The riveted double end hook stands up to rugged use while providing accurate measurements.

No. **Size**
GG299* 25' (7.6m) x1"



Kraft Tool Fractional Read Tape Measure

- Positive lock tape
- 16" markings for studs
- Compact smooth plastic case fits comfortably in the user's hand
- Fractions marked for easy reading

No. **Size**
GG339* 25'x1"

Walking Tape

Quickly and easily measure long distances. Heavy-duty wheel is long-lasting. Gear drive counter for accuracy. Non-Glare counter is easy to read. Measures up to 10,000' (1.89 miles) without resetting. Kickstand keeps tool upright when not in use. Folding handle for easy storage.

No. **Description**
GG283* Feet/Inches
GG283M* Metric



200' Tape Measure

- Nylon coated steel tape
- 16" marking for studs
- Top quality durable plastic case
- Handy easy reel handle

No. **Size**
GG298* 200'x1/2" (ft, in)

Utility Knife Replacement Blades with Dispensers

Blades come with convenient plastic dispenser. Fits most standard utility knives. Steel blade with 2 notches on top (.025" thickness). 100 Pack has hang holes for easy storage.

No. **Description**
DW078* 10 Pack Dispenser (carded)
DW079* 100 Pack Dispenser (carded)



Checked Handle Utility Knife

Checked grip will not slip out of your hand. Blade can be adjusted, but does not retract. Storage for extra blades in handle.

No. **Description**
DW199 Bulk Packed 48 per carton (Includes 3 blades each)
DW199C* with Display Card (Includes 5 blades each)

3-Way Utility Knife

Blade will not slip. Retractable blade can be adjusted to 3 positions. Light yet rugged aluminum body. Includes 3 blades.

No. **Description**
DW042 Bulk Packed 48 per carton
DW042C* with Display Card



DW199



DW042C

*See page 178

Double Pouch Style 11-Pocket Moccasin Leather Carpenter's Apron

Our top of the line leather apron made for the professional craftsman. Finest quality supple moccasin leather.

- Large double stitched nylon pockets
- Stress points rivet reinforced
- 2 large and 2 medium size nail pockets
- 6 small tool pockets • 25' tape pocket
- 2 strap leather hammer loops
- 1-1/2" combination square holder
- Adjustable 2" polypropylene web belt

No. WL028



Drywall Tool Pouch

The best heavy leather drywall tool pouch on the market. Features a 3"x2" steel hammer loop, plus six other tool loops and holders. Securely made with total rivet construction for heavy-duty use.

No. WL077



Promotional 10-Pocket Split Leather Carpenter's Apron

This outstanding value has top of the line features at a promotional price.

- Strong suede split leather
- 2 large and 2 medium size nail pockets
- 6 small tool pockets • 25' tape pocket
- 2 strap leather hammer loops
- Adjustable 2" polypropylene web belt

No. WL029



Flat Type Drywall Tool Pouch

A flat 9-compartment drywall tool pouch features 4 flared front pockets that hold pencils, knives, etc. A strong metal clip allows for any size tape to be carried. Also features a sharpening stone pocket, circle cutter pockets, and a 3"x2" steel hammer loop.

No. WL096



Deluxe 9-Pocket Nail Bag

A favorite of drywall installers. This deluxe 9-pocket drywall nail bag is made of the finest moccasin leather.

No. WL520

Deluxe 5-Pocket Nail Bag

Deluxe 5-pocket nail bag has 10" flared pocket, 4"x6" pouched pocket with 2 nail slots and hammer holder. All pockets are fully bound for long wear and lock stitched with strong nylon thread. Rivet reinforced. Strong but supple leather makes this bag one of our best.

No. WL044
WL045

Description
Left Side Hammer Loop
Right Side Hammer Loop



3-Pocket Nail Bag

This fine quality, genuine cowhide nail bag has 3 pockets to hold even more tools and nails than a standard bag.

No. WL516

A) Steel Hammer Loop

3"x2" Steel loop hammer holder made for easy insertion. Top grain leather is riveted for long wear. Fits easily on belt.

No. WL095

B) Hammer Holder with Sheath

3"x3" Steel hammer loop with sheath to hold knives or snips. Fits easily on belt.

No. WL093

C) Hammer and Hatchet Holder

2-1/2"x2" Steel loop. Loop swings freely to make carrying hammer easier. Made of heavy leather. Fits easily on belt.

No. WL403



1-Pocket Nail Bag

Popular nail bag made of soft but heavy chrome split leather. Lockstitching and riveting make this bag extremely sturdy. Bag has a bellowed flared pocket and wide tunnel belt loop.

No. WL046

