

FasGroov[®]

FABRICATING SYSTEM

Tools for Safe, Fast, Accurate Fabrication of
1 in. and 1-1/2 in. Fiberglass Ductboard

**We'll Show you
Step-by-Step!**



Malco[®]

Work. Perform. Outlast.



FasGroov[®]

FABRICATING SYSTEM

- Engineered for Superior Performance / Limited Lifetime Warranty
- Conçu pour fournir des performances exceptionnelles / Garantie limitée à vie
- Diseñado para un desempeño superior / Garantía de vida útil limitada

MALCO PRODUCTS INC. • 14080 HWY 55 NW • PO Box 400
Annandale, MN 55302 • www.malcotools.com

Malco[®] Work. Perform. Outlast.

KIT CONTENTS

VEE-GROOVE KITS



**Silver Tools
FGVK**
Vee Kit for
1 in. (25.4 mm)
Ductboard



**Gold Tools
FGVKL**
Vee Kit for
1-1/2 in. (38.1 mm)
Ductboard

1 inch Kit Cat. No.	1-1/2 inch Kit Cat No.	Description
FGVK	FGVKL	Vee-Groove Kit with following:
FGV1	FGL1	#1 Tool
FGV	FGLV	Vee Tool
FGV5	FGL5	#5 Tool
FGV6	—	#6 Tool
FGS	FGS	Square
FGK	FGK	Duct Knife
FGM	FGML	Male Shiplap Knife
FGF	FGFL	Female Shiplap Knife
FGC	FGC	Tool Case

SHIPLAP KITS



**Silver Tools
FGSLK**
Shiplap Kit for
1 in. (25.4 mm) Ductboard



**Gold Tools
FGSLKL**
Shiplap Kit for
1-1/2 in. (38.1 mm)
Ductboard

1 inch Kit Cat. No.	1-1/2 inch Kit Cat No.	Description
FGSLK	FGSLKL	Shiplap Kit with following:
FGV1	FGL1	#1 Tool
FGV24	FGL24	#2/4 Tool
FGV3	FGL3	#3 Tool
FGV5	FGL5	#5 Tool
FGV6	—	#6 Tool
FGS	FGS	Square
FGK	FGK	Duct Knife
FGM	FGML	Male Shiplap Knife
FGF	FGFL	Female Shiplap Knife
FGC	FGC	Tool Case

FasGroov[®]

FABRICATING SYSTEM

Introduction..... 4

SETTING UP TOOLS

Adjusting FasGroov Square..... 9
Hand Tool blade height adjustment..... 10
Blade removal / replacement..... 14

Shiplap Fabrication..... 16

Vee-Groove Fabrication..... 20

Related Tools and Accessories..... 24

The duct fabrication procedures outlined in this manual pertain to two common methods of one-piece duct construction in standard 1" OR 1-1/2" ductboard. For applications requiring ductwork larger than that which can be constructed from a single piece of ductboard, consult the NAIMA Fibrous Glass Duct Construction Standards Manual or your ductboard manufacturer's fabrication manual for information on the two-piece "U", two piece "L", and four-piece construction methods.

INTRODUCTION

Tool Features:

- **FasGroov Tool identification incorporates both the numbering system of fabrication machines and the traditional hand tool color coding system.** FasGroov Tools are available for both shiplap and vee-groove fabrication methods.
- **Easy, turn-the-knob, blade height adjustment.** Scrap lifts cleanly out of groove. Blades are also easily removed without removing screws.
- **Molded plastic handles are ergonomically designed to fit angle of grip and reduce arm and hand fatigue on-the-job.**
- **Extruded, anodized, aluminum body is durable and lightweight.** Grooved surface on sled bottom facilitates easy sliding.

Molded handles ergonomically designed to reduce arm and hand fatigue.

Easy turn-the-knob blade height adjustment compensates for thickness variations in standard 1 and 1-1/2 inch board.

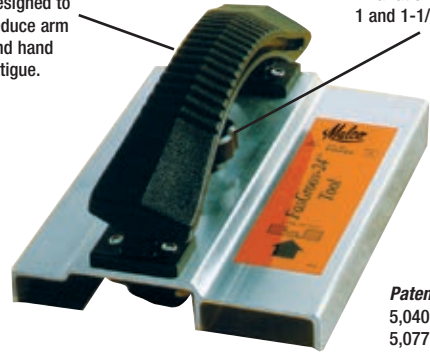

Patent No's.
5,040,297
5,077,899

Blades remove without removing screws.

Grooved sled bottom facilitates easy sliding.

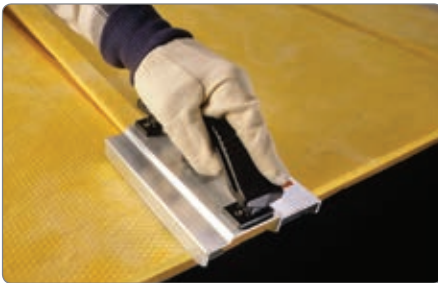
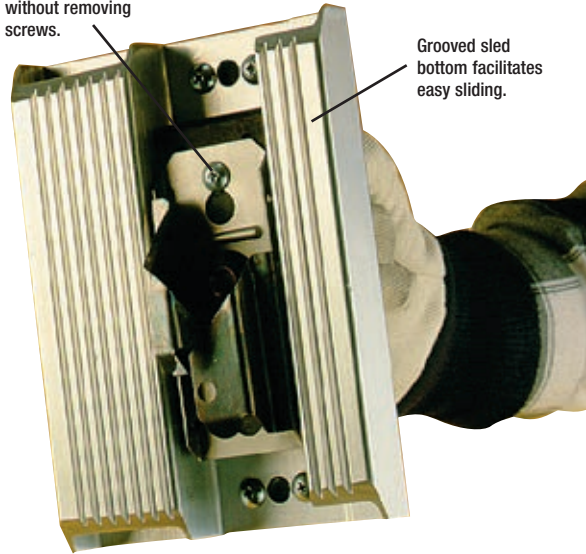

Sled glides easily and cleanly removes scrap piece out of groove.

Shiplap Method

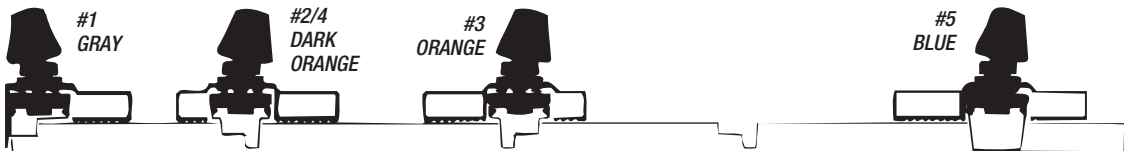

Vee-Groove Method

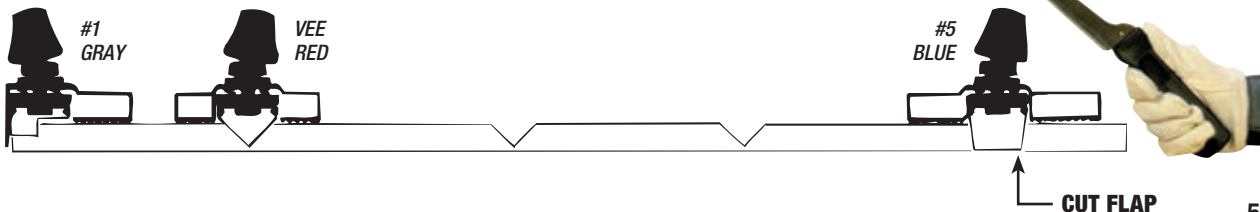

Use #6 Tool to shorten length of duct section, by measuring from outside edge of material to be scrapped.

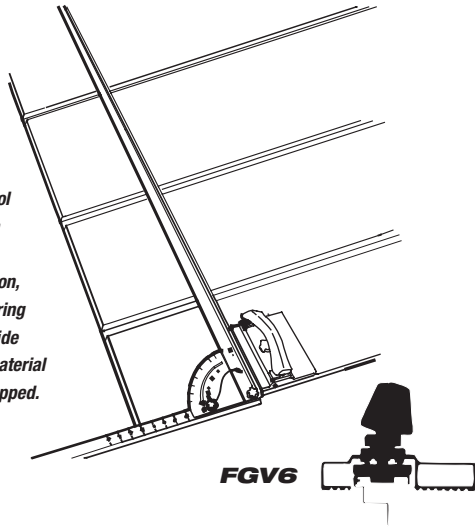

- 1" FasGroov kits also include a #6 tool (Tan color coded FGV6) for creating duct sections less than standard 4 foot lengths. The #6 replaces a shiplap knife for making a shiplap groove at fitting end prior to closure of duct section. The #6 may also be used for two-piece and four-piece ductboard fabrication.

FGV6

Use knob under handle to raise or lower blade and adjust depth of cut.

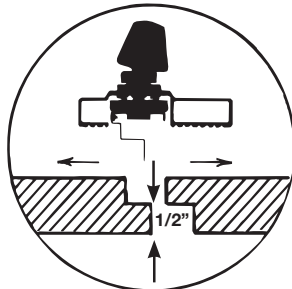
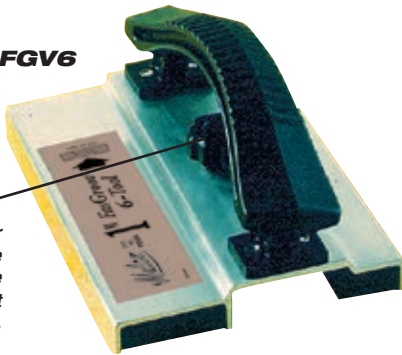

Easy one-piece layout:

- FasGroov Square** permits fast and accurate layout without marking cuts or calculating add-on dimensions. Lay out ductboard as you cut. Simply align dimension on FasGroov Square with right edge of previous cut and move across the board. Square is also easily adjustable for angled cuts.

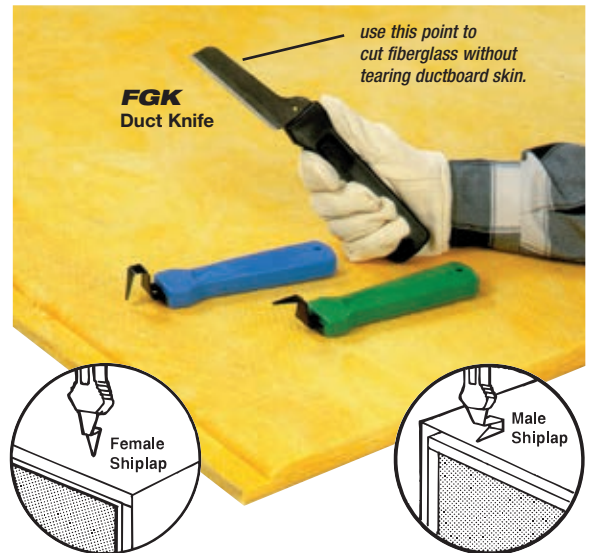

Single blade knives:

- Single blade FasGroov Knives** are safer to use and also feature comfortable molded handles. Male and Female Shiplap Knives can be used on closed duct sections.

For right or left hand use:

- Right hand orientation of 1" kits is easily changed by converting #5 Tool and FasGroov Square for left hand fabrication. Tool handles may also be turned around to provide left hand grip angle.

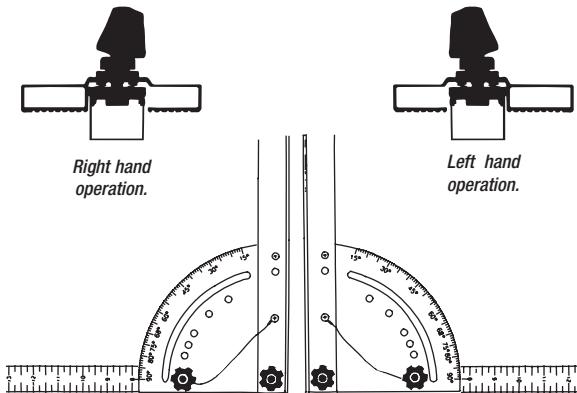

CONVERTING FASGROOV SQUARE FOR LEFT HAND USE.

1. Remove the angle adjustment knob and the end pivot knob.
2. Position the ruler stamped leg so that the 3 holes are to your left. (Rule reads left to right.)
3. Remove the protractor for the "L" shaped leg by removing the two screws.
4. Flip the protractor over and install on the opposite end of the "L" shaped leg.
5. Place the "L" leg/protractor assembly on top of the ruled leg.
6. Align the pivot knob holes and install the pivot knob.
7. Install the angle adjustment knob in any of the fixed positions or the sliding position.
8. After converting your square for left hand use, double check the accuracy in the fixed 90° position with a roofing square. Built-in manufacturing hole tolerances will allow you to true the square.

Note: 1-1/2" Kits cannot be converted for left hand use.

SETTING UP TOOL Adjusting Fasgroov Square:

PREDETERMINED SETTINGS

Place adjustment knob into hole corresponding to most used angles.

OTHER ANGLES

Place adjustment screw into protractor adjustment slot and tighten at desired angle.

STORAGE

Step 1:

Remove angle adjustment knob and fold ends of FasGroov Square together.

Step 2:

Place angle adjustment knob into the storage hole and tighten.

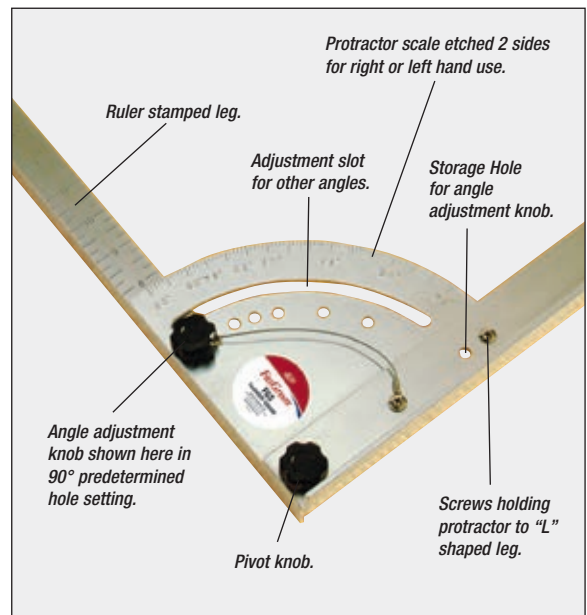

Hand Tool blade height adjustment:

FASGROOV #1 TOOL

Push the FasGroov #1 Tool along the left edge of a test piece of ductboard. Measure the depth of cut of the female shiplap groove, it should be half the thickness of the ductboard (see illustration).

If adjustment is needed: (1) Turn the blade adjustment knob counterclockwise to lower the blade for a deeper cut or (2) Turn the blade adjustment knob clockwise to raise the blade for a shallower cut. Repeat adjustment until the proper depth of cut is achieved.

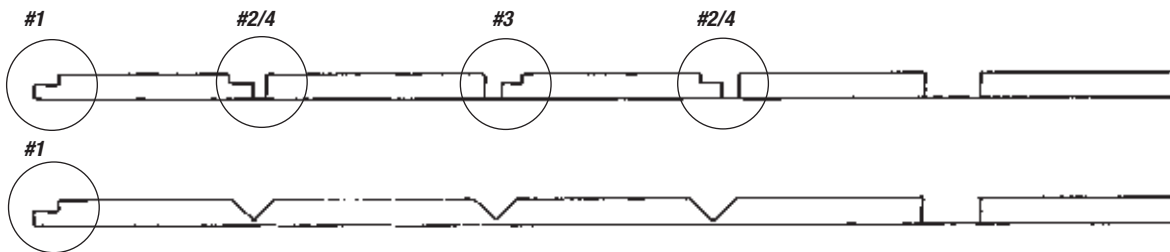
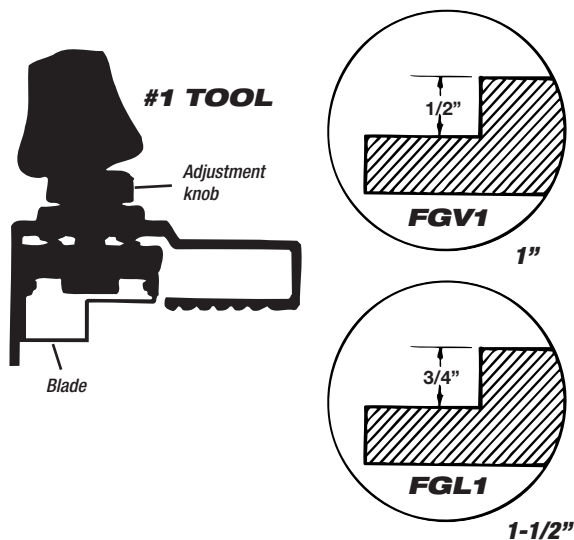

FASGROOV #2/4 and #3 TOOLS

Push the FasGroov #2/4 Tool and FasGroov #3 Tool through a test piece of ductboard. Measure the amount of fiberglass remaining between the foil backing and the deepest part of the shiplap cut (see illustration).

If adjustment is needed: (1) Turn the blade adjustment knob counterclockwise to lower the blade for a deeper cut or (2) Turn the blade adjustment knob clockwise to raise the blade for a shallower cut.

Repeat adjustment until the proper depth of cut is achieved.

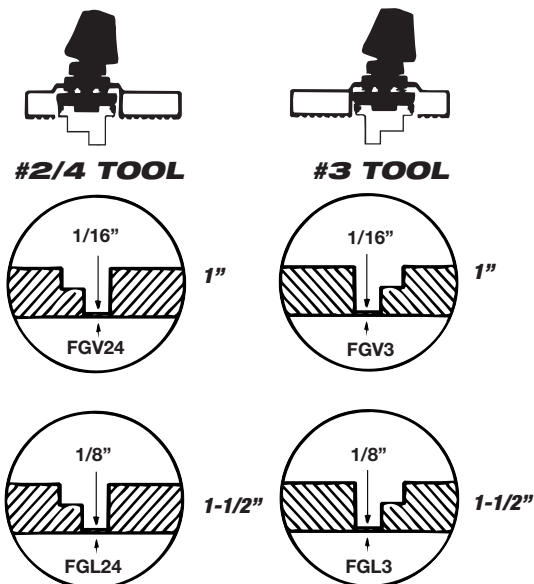

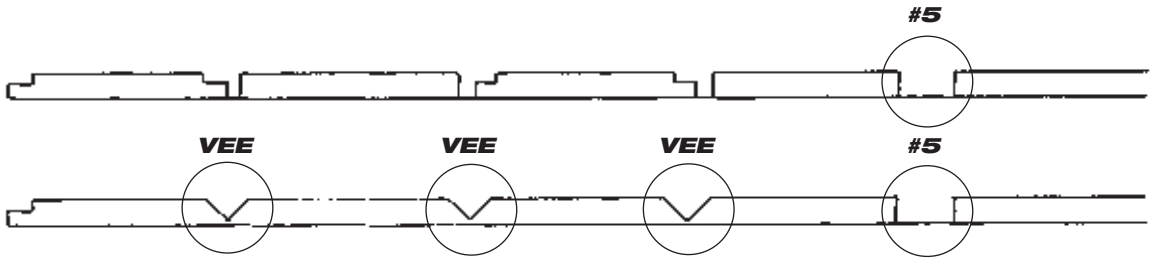

FASGROOV-VEE TOOL

Push the FasGroov-Vee Tool through a test piece of ductboard.

Measure the amount of fiberglass remaining between the foil backing and the deepest part of the vee-groove cut. There should be 1/8" of fiberglass remaining (see illustration for width of cut.)

If adjustment is needed: (1) Turn the blade adjustment knob counterclockwise to lower the blade for a deeper cut or (2) Turn the blade adjustment knob clockwise to raise the blade for a shallower cut.

Repeat adjustment until the proper depth of cut is achieved.

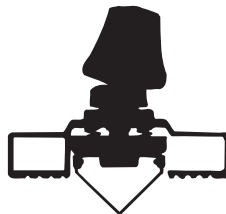
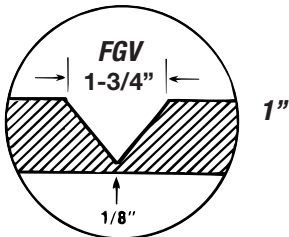

VEE TOOL

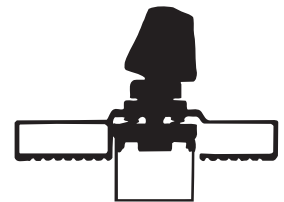
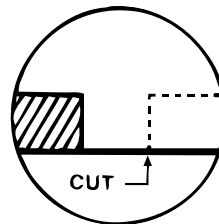
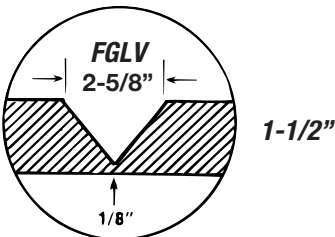

#5 TOOL

*Use FGK Knife
to cut staple flap.*

Blade removal, replacement:

Since the blade adjustment mechanism is the same for all FasGroov Tools, this procedure applies to any tool requiring blade removal/replacement.

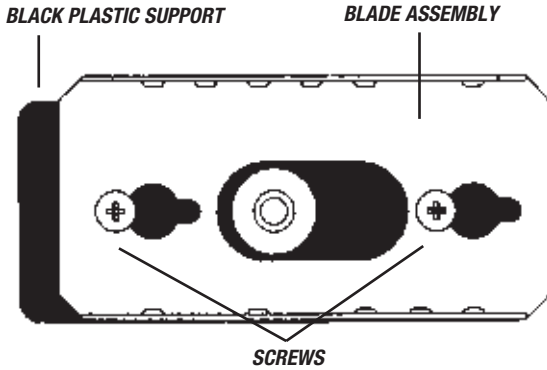

Loosen Screws

Slide and remove worn blade assembly.

Place new blade into the black plastic support and retighten screws.

Note: Initial cutting friction may be realized due to rust prevention factory finish on the blade.

***Blades remove
without removing
screws.***

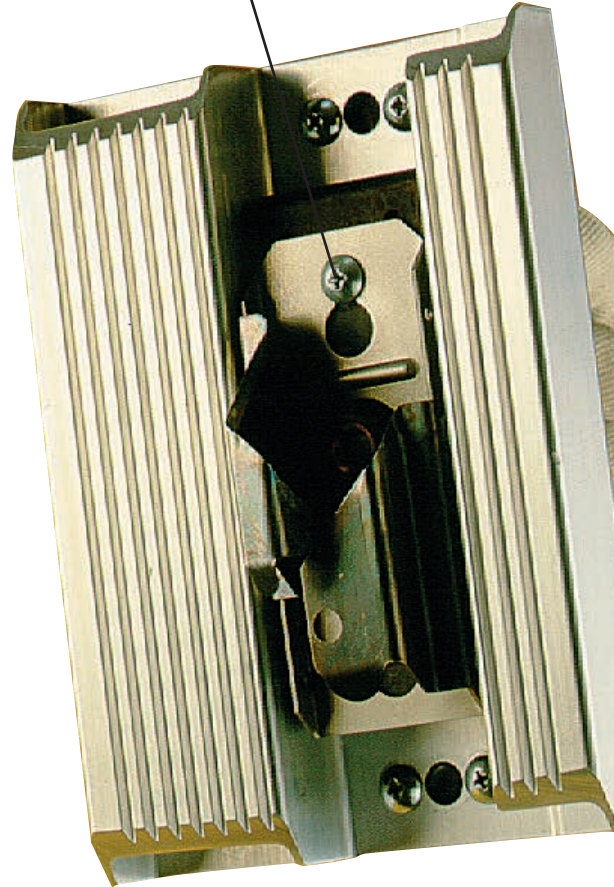

SHIPLAP FABRICATION

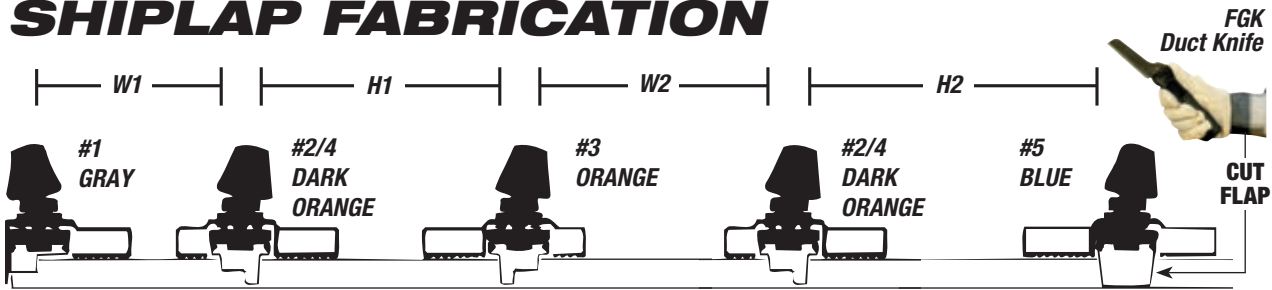

Work left to right facing the factory-made female shiplap edge as your base edge for a standard 4-foot deep ductboard section.

Place the FasGroov #1 Tool flush against the left edge of the ductboard. Push the tool along length of left edge to produce a female shiplap groove.

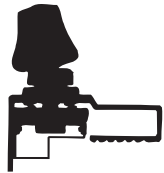

#1 TOOL

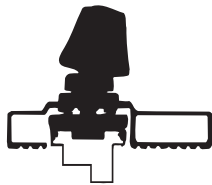

#2/4 TOOL

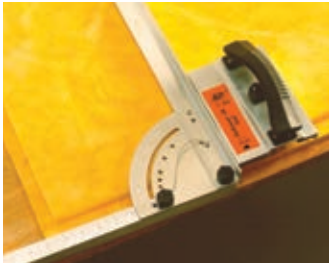

Set the FasGroov Square on top of the ductboard. Place the ruled edge of the square flush against the base edge of the board.

Locate your desired inside duct width dimension ($W1$) on the ruled edge of square and move the square along the board base to align your width dimension with the right edge of the previous cut made with the #1 Tool. Place the left side of the FasGroov #2/4 Tool flush against the arm of the square and push the #2/4 tool along the arm's length to produce a right hand shiplap groove.

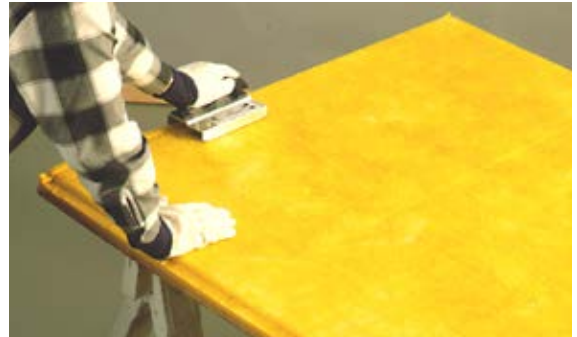

Locate your desired inside duct height dimension ($H1$) on the ruled edge of the FasGroov Square and move square to the right along base of ductboard to align your height dimension with the right edge of the previous cut made with the #2/4 Tool. Place the left side of the FasGroov #3 Tool flush against the arm of the square and push the #3 tool along arm's length to produce a left hand shiplap groove.

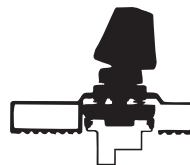

#3 TOOL



SHIPLAP FABRICATION

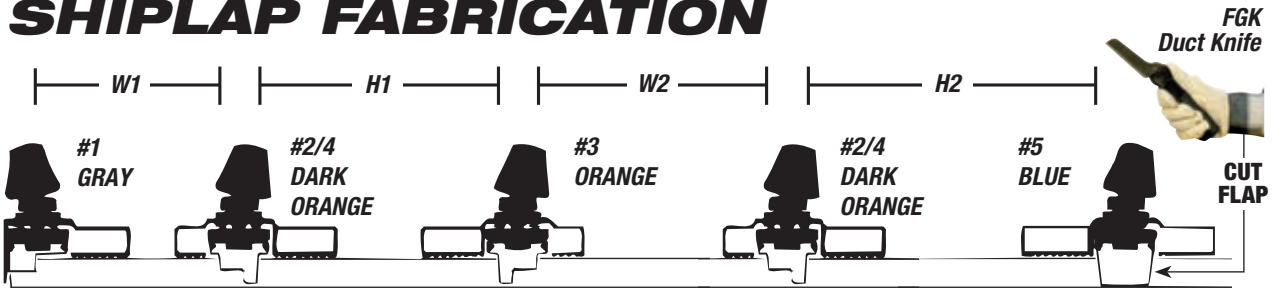

Move the square to the right again to align your width dimension (W2) with the right edge of the previous cut made with #3 Tool. Place the left side of the FasGroov #2/4 Tool flush against the arm of the square and push the #2/4 along arm's length to produce a second right hand shiplap groove.

Move the square one last time to align your height dimension (H2) with the right edge of the previous cut made with #2/4 Tool. Place the left side of the FasGroov #5 Tool flush against the arm of the square and push the #5 along arm's length to produce a staple flap groove.



Insert the FGK FasGroov Duct Knife into the right edge of the staple flap cut made with the #5 Tool. Cut completely through the foil to finish the grooving process.



Fold the duct Section together. Staple and tape the flap, join duct sections and install take-offs with manufacturer-approved products.

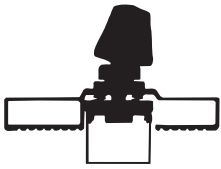

#5 TOOL

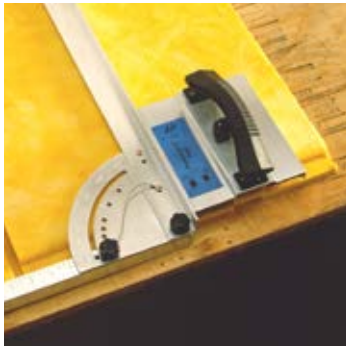

VEE-GROOVE FABRICATION

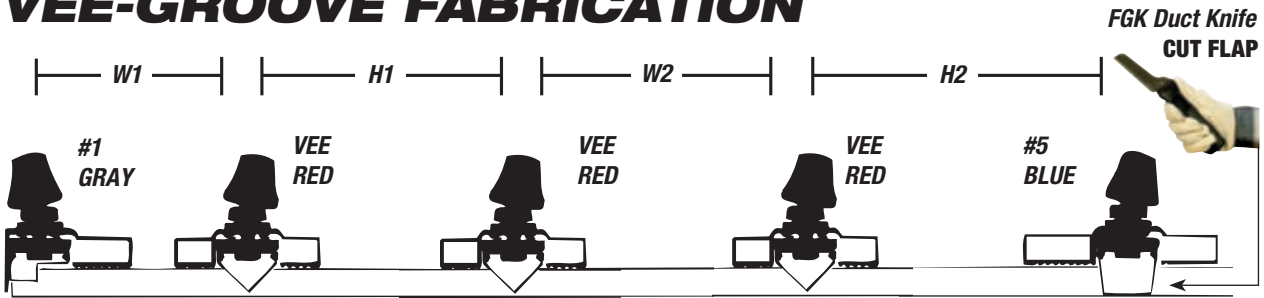

Work left to right facing the factory-made female shiplap edge as your base edge for a standard 4-foot deep ductboard section.

Place the FasGroov #1 Tool flush against the left edge of the ductboard. Push the tool along length of left edge to produce a female shiplap groove.



Locate your desired inside duct height dimension (H1) on the ruled edge of the FasGroov Square and move square to the right along base of ductboard to align your height dimension with the right edge of the previous cut made with the Vee Tool. Again place the left side of the Vee Tool flush against the arm of the square and push the tool along arm's length to produce a vee groove.



Set the FasGroov Square on top of the ductboard. Place the ruled edge of the square flush against the base edge of the board.

Locate your desired inside duct width dimension (W1) on the ruled edge of square and move the square along the board base to align your width dimension with the right edge of the previous cut made with the #1 Tool. Place the left side of the FasGroov-Vee Tool flush against the arm of the square and push the Vee Tool tool along the arm's length to produce a vee groove.



VEE-GROOVE FABRICATION

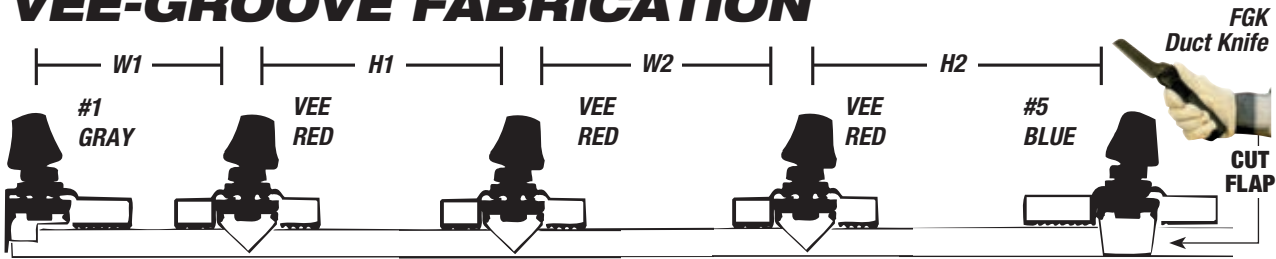

Move the square to the right to align your width dimension (W2) with the right edge of the previous cut. Place the left side of the Vee Tool flush against the arm of the square and push the tool along arm's length to produce a third vee groove.

Move the square one last time to align your height dimension (H2) with the right edge of the last cut made with Vee Tool. Place the left side of the FasGroov #5 Tool flush against the arm of the square and push the #5 along arm's length to produce a staple flap groove.



Insert the FGK FasGroov Duct Knife into the right edge of the staple flap cut made with the #5 Tool. Cut completely through the foil to finish the grooving process.

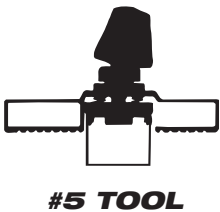

Fold the duct section together. Staple and tape the flap, join duct sections and install take-offs with manufacturer-approved products.

Galvanized Volcano Reinforcement Washers

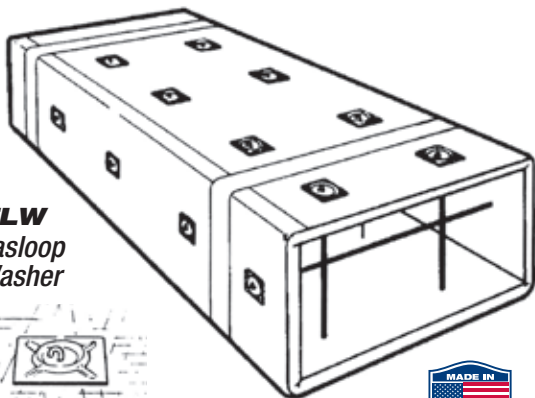

FLW
Fasloop
Washer



For use with wire-reinforced fiberglass ductboard walls to restrict duct wall deflection on positive pressure supply ducts. The volcano profiled reinforced washer seats flush to the ductboard surface. A 1/8-inch (3.18 mm) diameter hole accepts 12-gauge wire.

Cat. No.

FLW	
Dimensions in. (mm)	2 1/2 x 2 1/2 x .030 (64 x 64 x 0.76)
Hole Dia. in. (mm)	1/8 (3.18)

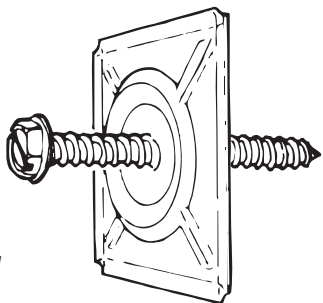

RW732
Reinforcing
Washer

Use for fastening sheet metal components to fiberglass ductboard. The volcano profiled reinforced washer seats flush to the ductboard. A 7/32-inch (5.56 mm) hole accepts a #8 screw.

Cat. No.

RW732	
Dimensions in. (mm)	2 1/2 x 2 1/2 x .030 (64 x 64 x 0.76)
Hole Dia. in. (mm)	7/32 (5.56)

Hole Cutter for Fiberglass Ductboard



FG1

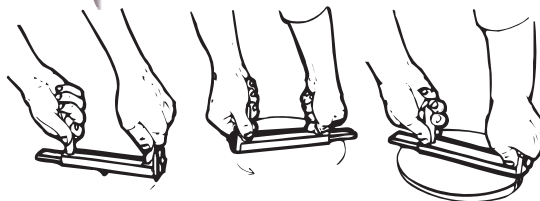

Cuts 4 to 20" (102 to 508 mm) diameter holes in both 1" (25.4 mm) and 1-1/2" (38.1 mm) fiberglass duct.

Operation is fast and easy.

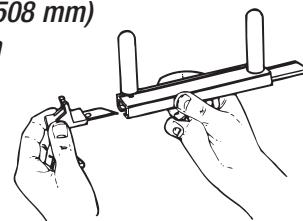

Supplied with a standard utility knife blade that safely stores in handle. Hole Cutter can also use the KBHC replacement blade for cutting 1-1/2" ductboard.

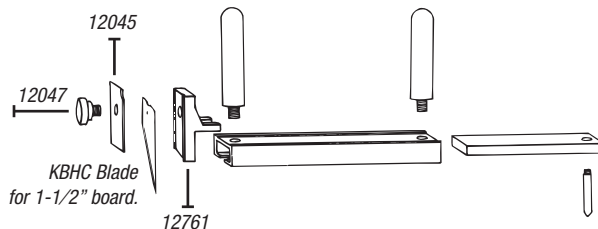

Cat. No.	Description	Net Weight oz. (g)
FG1	Fiberglass Duct Hole Cutter	7-1/2 (213)

REPLACEMENT 1-1/2" BLADE

KBHC	1-1/2" Blade for FG1 Hole Cutter	
-------------	----------------------------------	--

Duct Knife

Cuts Ductboard and Flex Duct!

For cutting flexible fiberglass wool duct and ductboard. Double edge blades are ideal for blind cuts in "flex" duct.

Serrated edge aids cutting "flex" fiberglass wool duct.

DK6S

Ergonomic cushioned handle offers comfortable, sure grip.



Puncture resistant nylon sheath included with DK6S cushion gripped knife.

Cat. No.	
DK6S	
Blade Length in. (mm)	6 (152)
Net Weight oz. (g)	7 (199)



Flex Duct Cutter

It also cuts the wire rib coil!

Double edged blade cleanly pierces through outer skin and fiberglass wool insulation and cuts in either direction around the duct circumference. Use the handy built-in wire cutter to cut the hardened wire rib coil.



Fine Honed Stainless Steel Double Edged Knife Blade

FDC1



Wire Cutter

Compound Leverage

Comfortable Contour Vinyl Gripped Handles

Double edged blade cleanly pierces duct, cuts both directions.

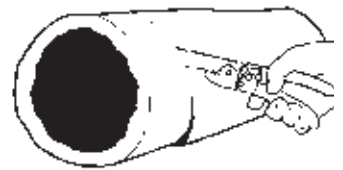

Built-in wire cutter completes the job by severing wire rib coil.

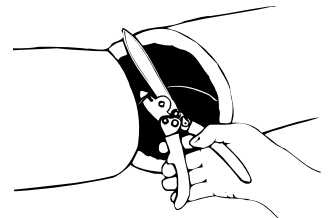

Cat. No.	
FDC1	
Length of Cut in. (mm)	4 (102)
Tool Length in. (mm)	11-7/8 (302)
Net Weight oz. (g)	11 (312)



Flex Duct Shear

Scissor action plus wire cutter!

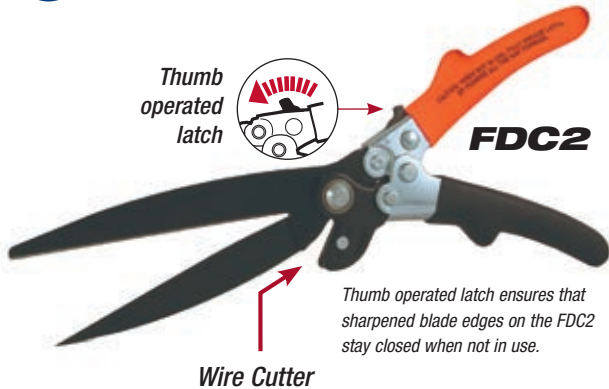

The shear's pointed bottom blade easily pierces duct to start the cut. The handy wire cutter is located away from the scissor blade edges. And a thumb-operated latch ensures that the blade edges stay closed when not in use. Double edged blade cleanly pierces through outer skin and fiberglass wool insulation and cuts in either direction around the duct circumference. Use the handy built-in wire cutter to cut the hardened wire rib coil.



Cat. No.	
FDC2	
Length of Cut in. (mm)	4-3/8 (111)
Tool Length in. (mm)	12-1/4 (311)
Net Weight oz. (g)	13 (369)



Multi-Purpose Flex Duct Tool

A knife, wire cutter & tie tool!

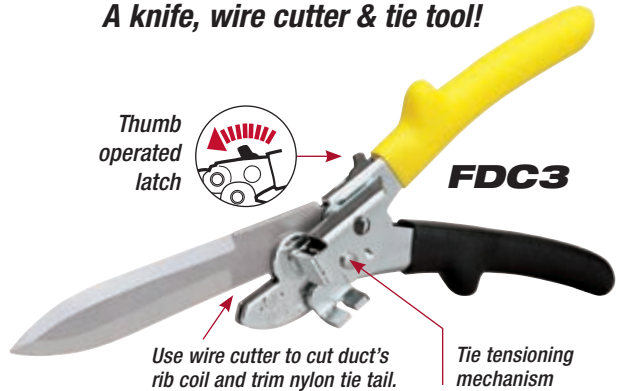

Double edged blade cleanly pierces through outer skin and fiberglass wool insulation and cuts in either direction around the duct circumference. Use the handy built-in wire cutter to cut the hardened wire rib coil. Use the tie tensioning mechanism to install a nylon tie strap that secures flex to a take-off collar. Use the wire cutter to cut excess nylon tie tail.



Cat. No.	
FDC3	
Length of Cut in. (mm)	4 (102)
Tool Length in. (mm)	11-7/8 (302)
Net Weight oz. (g)	14 (397)



Manual Cut-Off Tensioning Tools

Non-slip, notched gripper!



U.S. Patent No. 5,048,575



Gripped TY4G and Un-Gripped TY4 Manual Cut-Off Models feature comfortable handle openings and reduced pinch-point. These long-life tools also feature a unique, non-slip, notched gripper to ratchet and set thick and thin nylon ties.

Cat. No.

TY4 / TY4G (Gripped)

Tool Length in. (mm)	6 (152)
TY4 — Net Weight oz. (g)	10 (284)
TY4G — Net Weight oz. (g)	11 (312)



Adjustable High Leverage Tensioning Tool

Features Automatic Cut-Off!

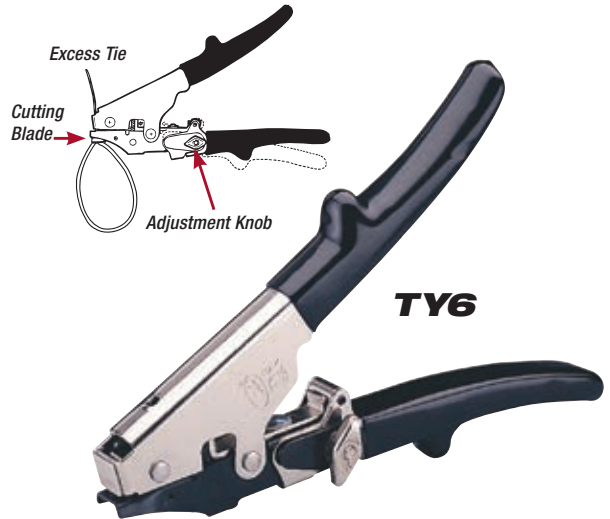

Features hardened steel stampings with weather resistant nickel chrome finish.

U.S. Patent No. 5,048,575



TY6 Model with Automatic Cut-Off can be set to engage blade and cut off the nylon tie tail when desired tension is reached. Designed for continuous use on thick ties, the TY6 features contoured cushion gripped handles and a long-life notched gripper.

Cat. No.

TY6

Tool Length in. (mm)	8-1/2 (216)
Net Weight oz. (g)	15 (425)



UV Resistant Adjustable Nylon Ties



Type 21S
AH-2
Supporting
Device
E487573 23MW

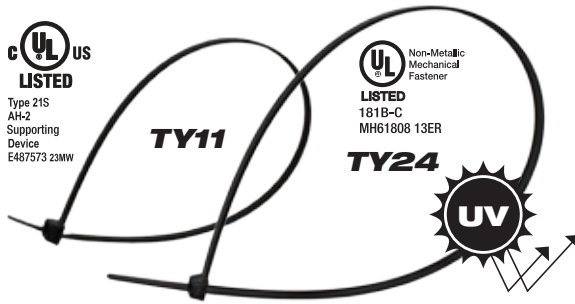

Non-Metallic
Mechanical
Fastener
LISTED
181B-C
MH61808 13ER

TY24



These Outdoor Rated UV Resistant Ties are made of 100% Nylon. A one-piece adjustable, self-locking design makes them easy to install for a multitude of outdoor applications.

	TY11	TY24
Overall Length in. (mm)	11 (279)	24 (610)
Width in. (mm)	3/16 (4.57)	3/8 (9.5)
Thickness in. (mm)	3/64 (1.32)	3/32 (2.29)
Min. Tensile Strength lbs.	50	175
Max. Adjustable Dia. in. (mm)	3-1/16 (78)	7-3/16 (179)
Color	Black	Black
For Malco Tie Tools	TY4, TY4G	TY4, TY4G, TY6



Jumbo Heavy-Duty Adjustable Nylon Ties



Non-Metallic
Mechanical
Fastener
LISTED
181B-C
MH61808 13ER

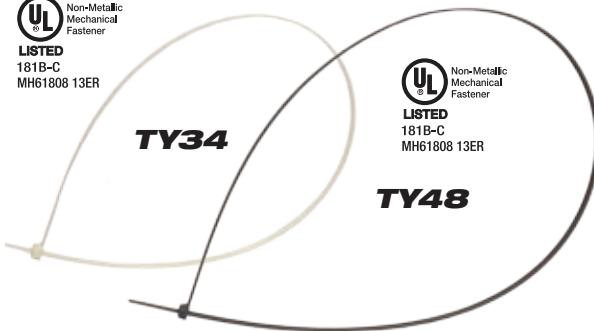

Non-Metallic
Mechanical
Fastener
LISTED
181B-C
MH61808 13ER

TY48

These Indoor Rated Ties are made of 100% Nylon. A one-piece adjustable, self-locking design makes them easy to install for a multitude of indoor applications. Uses include securing HVAC duct take-offs and securing/bundling heavy tubing, hoses and cables.

	TY34	TY48
Overall Length in. (mm)	36 (914)	48 (1219)
Width in. (mm)	3/8 (9.5)	3/8 (9.5)
Thickness in. (mm)	3/32 (2.29)	3/32 (2.29)
Min. Tensile Strength lbs.	175	175
Max. Adjustable Dia. in. (mm)	11 (279)	14-1/2 (368)
Color	Natural	Gray
For Malco Tie Tools	TY4, TY4G, TY6	TY4, TY4G, TY6



Flex Duct Support

Supports 90°
Flex Duct Elbow!



Quickly installs on 4-inch to 16-inch diameter flexible fiberglass wool duct to support a 90° elbow support. Reduces energy consumption by eliminating air flow restrictions and increasing air flow efficiency. Lightweight, 100% recycled polymer construction. Use with 36-inch and 48-inch nylon ties (Malco TY34 and TY48).

Cat. No.

FDS1

Nom. Dimensions in. (mm)	15 x 11-1/4 x 3 (38.1 x 28.6 x 7.6)
Net Weight oz. (g)	3 (85)

