

Catalog

2017

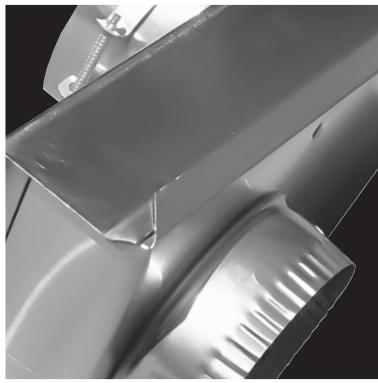

201 Broiles Drive
Jacksonville, TX 75766
Tel: 888-368-7233
Fax: 800-259-8368
buildersbest.com

inVenting Solutions



Growth since 1990

With over 200,000 square feet of manufacturing and distribution space, we are able to react very quickly to your needs.

Beginning with raw materials, our aluminum, plastic, and paperboard are specified and ordered often a year in advance. Turret presses, stamping, and duct forming create multiple lines to feed flexible assembly processes. Our plastics injection molding operation runs continually. On-site printing presses handle 75% of our packaging and point-of-purchase needs. These vertical integration enhancements help us manage inventory with extreme efficiency. We achieve these levels of integration via internal growth and outside acquisitions.



Whether it's for the dryer, bath, kitchen, or HVAC venting, we have the products and accessories in the right packaging to fit your space.

In 1990, we began installing clothes dryers with unique solutions, often imitated but never equalled. Twenty-five years and forty patents later, this family owned and operated company is the primary source for professional dryer venting in North America. We proudly manufacture in the U.S.A. at two manufacturing plants located in Texas and Florida. Strategic partners are helping us expanding our reach into Canada and beyond. As a vertically integrated company, we design, engineer, tool, manufacture, print and package in-house. From quick-ship to truckloads, you are our priority.

Builder's Best, Inc. • 201 Broiles Drive • Jacksonville, TX 75766



www.buildersbest.com • 1-800-368-7233

DUCT

SEMI RIGID

UL® AIR DUCT

V750 Universal Collars 4
V350-U Uncompressed 4
V250 Plain Ends 4
A100 Uncompressed 5
A100 Stretch-Fit™ 5
A300 Insulated Silver 5

NON-UL®

V330 PRO Crimped 6
V331 PRO Double Crimp 6
V230 PRO Plain Ends 6
V320 Crimped One End 7
V321 Double Crimp 7
V220 Plain Ends 7
V730 Double Female 7

RIGID

Galvanized Pipe & Elbow 8
V030 Aluminum 8
V020 Aluminum 8
V010 Aluminum 8
Long Sweep Elbow 8
Adjustable Elbow 8

FOIL & VINYL

Foil Duct 9
UL® Foil Kits 9
SilverDuct™ UL® 10
Indoor Lint Traps 10
Vinyl Hose 11
Bath Vent Kits 11
ClearDuct 11

VENT HOODS

WALL VENTS

GALVANIZED

GWM088 Heavy Duty 12
GWM271 P-Tanium™ 14
GWM271 Spangled 14

ALUMINUM

AWM088 Heavy Duty 13
AWM088 6" Spring 13
AWM271 Wide Mouth 15
ASM277 Standard Mouth 15
Rectangular 15

PLASTIC

SM Series 16
WC Series 16
J Block 16
PWM113 Wide Mouth 17
Pest Guards 17
PML282 Louvered 18

EAVE VENTS

ALUMINUM

AEV199 Eave Vents 19
AFL535 Micro Louver 19

PLASTIC

PFL812 Mini Louver 20
PEV802 Eave Vent 20
SV28 Soffit Vent 21
RDV Round Soffit 21
WG Diffusers 21

ROOF VENTS

GALVANIZED

GRV635 Black 24
GRV635 Spangled 24
Umbrella Cap 25
Creative Crown 25
Broad Band 25

ALUMINUM

ARV635 24

PLASTIC

RV28 26
RVL28 26
RV20 26

ACCESSORIES

Diffusers 21
Clamps 22
Aluminum Tailpipes 22
UL® Foil Tape 22
Draft Stopper 23
Heat Diverter 23
Aluminum Trim Plates 23
Incraser/Reducers 23
Couplings 23
Extension collar 28

Model Code

GWM088

G=Galvanized *Style= similar*
W=Wide *features*
M=Mouth

DRYER VENTING

ELBOWS

Close Elbow® 27
Wall Offset Elbow® 27
Dryer Offset Elbow® 27

SEMI RIGID

V830 Builder's Best® 28
V530 E-Z-Fasten™ 28
V430 Readi-Pipe™ 28

UL® SEMI RIGID

V450-TD UL® 29
V250-TD UL® 29

DRYER VENT KITS

UL® Dryer Vent Kits 30
SEK UL® 30
Close Loop™ 30
Over-the-Top® 30 & 31
Installer's Kit™ 30 & 31
Metal Kits with Elbows 31
Metal Kits with Hoods 31

PERISCOPES

Zero Periscope™ 32
18-29" 32
29-50" 32
Extension Pieces 32
Galvanized 29-74" 33
Aluminum 29-74" 33
Recessed Eave Vent 33
Transitions 34

DRYER OUTLET BOX

Dryer Outlet Box 34
8' & 10' Kits 34

UL® AIR DUCT

V750 AIR DUCT

- Universal male/female collar on each end
- 8' pieces compressed to 32"
- Factory installed universal male/female collars ensure uniform, air tight connections.
- UL® 181 label



Diameter	Length	Part #	Qty	Package
5"	8'	110344	9	bulk
6"	8'	110345	4	bulk
	8'	010346	9	bulk
7"	8'	110347	4	bulk
8"	8'	110348	4	bulk
	8'	010349	9	bulk
9"	8'	110350	4	bulk
10"	8'	110351	4	bulk
12"	8'	010352	1	ind. box
14"	8'	010353	1	ind. box
16"	8'	010354	1	ind. box
18"	8'	010355	1	ind. box
20"	8'	010356	1	ind. box
22"	8'	010357	1	ind. box
24"	8'	010358	1	ind. box

V350-U AIR DUCT

- 8' length
- One end crimped, one end plain
- Un-compressed
- UL® 181 label



Diameter	Length	Part #	Qty	Package
3"	8'	110744	42	bulk
4"	8'	110745	25	bulk
5"	8'	110759	16	bulk
6"	8'	110760	12	bulk
7"	8'	110761	9	bulk
8"	8'	110762	6	bulk
9"	8'	110763	5	bulk
10"	8'	110764	4	bulk
12"	8'	110755	2	ind. box

V250 AIR DUCT

- 8' and 10' lengths
- Plain Ends
- Compressed
- UL® 181 label

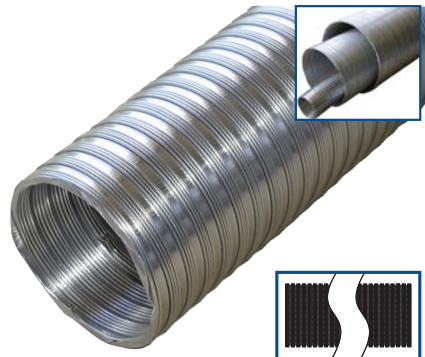

Diameter	Length	Part #	Qty	Package
3"	8'	110803	56	bulk
	10'	110801	40	bulk
4"	8'	110804	30	bulk
	10'	110802	24	bulk
5"	8'	110805	15	bulk
	10'	110690	15	bulk
6"	8'	110806	12	bulk
	10'	110691	12	bulk
7"	8'	110807	8	bulk
	10'	110692	6	bulk
8"	8'	110808	6	bulk
	10'	110693	6	bulk
9"	8'	110809	5	bulk
10"	8'	110810	4	bulk



Builder's Best purchased Metalflex® of Atlanta Georgia in 2005.
This is the strongest duct we make.

UL® AIR DUCT

MODEL A 100 AIR DUCT

- Uncompressed full 8' lengths
- Uninsulated
- Factory crimp on one end
- UL® 181 label.



Diameter	Part #	Qty	Package
3"	111253	42	bulk
4"	111254	25	bulk
5"	111255	16	bulk
6"	111256	12	bulk
7"	111257	9	bulk
8"	111258	6	bulk
9"	111259	5	bulk
10"	111260	4	bulk
12"	111261	4	bulk
14"	111262	4	bulk
16"	011263	1	ind. box
18"	011264	1	ind. box
20"	011265	1	ind. box
24"	011266	1	ind. box

MODEL A 100 STRETCH-FIT™ AIR DUCT

- 8' lengths compressed to 29"
- Uninsulated
- Factory crimp on one end
- UL® 181 label.



Diameter	Part #	Qty	Package
3"	111356	12	bulk
4"	111357	8	bulk
5"	111358	5	bulk
6"	111270	8	bulk
7"	111271	6	bulk
8"	111272	4	bulk
9"	111273	4	bulk
10"	111274	3	bulk

MODEL A 300 SILVER

- Uncompressed 8' lengths
- Factory crimp on one end
- Insulated - R4, R6, R8
- Outer jacket is silver "metalized" with scrim mylar vapor barrier.
- UL® 181 label



R4

Diameter	Part #	Qty	Package
4"	111307	12	bulk
5"	111308	9	bulk
6"	111309	8	bulk
7"	111310	5	bulk
8"	111311	4	bulk
9"	111312	4	bulk
10"	111313	4	bulk
12"	111314	4	bulk
14"	111315	3	bulk
16"	011316	1	ind. box
18"	011317	1	ind. box
20"	011318	1	ind. box
24"	011319	1	ind. box

R6

Diameter	Part #	Qty	Package
3"	111320	16	bulk
4"	111321	12	bulk
5"	111322	9	bulk
6"	111323	6	bulk
7"	111324	4	bulk
8"	111325	4	bulk
9"	111326	4	bulk
10"	111327	4	bulk
12"	111328	3	bulk
14"	111329	2	bulk
16"	011330	1	ind. box
18"	011331	1	ind. box
20"	011332	1	ind. box
24"	011333	1	ind. box

R8

Diameter	Part #	Qty	Package
3"	111661	16	bulk
4"	111662	12	bulk
5"	111663	9	bulk
6"	111664	6	bulk
7"	111665	4	bulk
8"	111666	4	bulk
9"	111667	4	bulk
10"	111668	4	bulk
12"	111669	3	bulk
14"	111670	2	bulk
16"	011671	1	ind. box
18"	011672	1	ind. box
20"	011673	1	ind. box
24"	011674	1	ind. box

Builder's Best® purchased Thermofin® of Florida in 2007.
Model A has a core of A100 flexible aluminum duct wrapped in fiberglass insulation.



SEMI-RIGID ALUMINUM DUCT

V330

- One crimped end and one plain end
- Non-insulated general purpose venting duct for low and medium operating pressures.
- Non-combustible corrugated aluminum with water-tight continuous lockseams.
- Class 0 metal duct.



Diameter	Length	Part #	Qty	Package
3"	8'	011489	20	bulk
4"	8'	011491	12	bulk
5"	8'	011493	6	bulk
6"	8'	110317	4	bulk
7"	8'	110319	4	bulk
8"	8'	110320	4	bulk
9"	8'	110322	4	bulk
10"	8'	110323	4	bulk
12"	8'	110246	4	bulk

V331

- Same as V330 but with a Double Crimp on one end.

Diameter	Length	Part #	Qty	Package
3"	8'	011450	20	bulk
4"	8'	011452	12	bulk

V230

- Same as V330, but with Plain ends

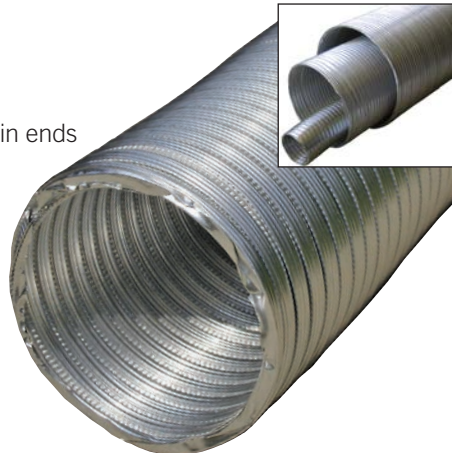

Diameter	Length	Part #	Qty	Package
3"	8'	110250	20	bulk
	10'	110251	20	bulk
	20'	110401	25	bulk
	25'	110252	25	bulk
4"	8'	110087	12	bulk
	10'	110253	12	bulk
	20'	110402	16	bulk
5"	8'	110315	16	bulk
	10'	011476	6	bulk
	20'	110256	9	bulk
6"	8'	110257	9	bulk
	10'	011479	4	bulk
	20'	110259	12	bulk
7"	8'	110260	6	bulk
	10'	110262	8	bulk
	20'	110263	4	bulk
8"	8'	110264	4	bulk
	10'	011487	6	bulk
	20'	110266	4	bulk
9"	8'	110267	4	bulk
	10'	110268	4	bulk
	20'	110269	4	bulk
10"	8'	110383	4	bulk
	10'	110384	4	bulk
	20'	110385	4	bulk
12"	8'	110247	4	bulk
14"	8'	110248	2	bulk

With two steel screw clamps:

4"	8'	110460	12	Display Bag
-----------	-----------	---------------	-----------	--------------------



The Builder's Best® PRO versions are heavier and stronger.

Parts in Red indicate Display Packaging.

SEMI-RIGID ALUMINUM DUCT

V320

- One crimped end and one plain end
- Non-insulated general purpose venting duct for low and medium operating pressures.
- Non-combustible corrugated aluminum with water-tight continuous lockseams.
- Class 0 metal duct.



Diameter	Length	Part #	Qty	Package	UPC
3"	8'	110443	10	Display Bag	•
	8'	011458	20	bulk	
4"	8'	110444	12	Display Bag	•
	8'	110434	12	bulk	
	20'	110439	16	bulk	
5"	8'	110445	6	Display Bag	•
	8'	110435	6	bulk	
6"	8'	011463	4	Display Bag	•
	8'	010431	4	bulk	
7"	8'	011465	4	Display Bag	•
	8'	011466	4	bulk	
8"	8'	011468	4	Display Bag	•
	8'	011469	4	bulk	

V321

- Same as V320 but with a Double Crimp on one end.

Diameter	Length	Part #	Qty	Package
3"	8'	011471	20	bulk
4"	8'	110584	12	bulk
5"	8'	110585	6	bulk
6"	8'	011473	4	bulk
7"	8'	011474	4	bulk
8"	8'	011475	4	bulk

V220

- Same as V320 but with Plain Ends



Diameter	Length	Part #	Qty	Package	UPC
3"	8'	110453	10	Display Bag	•
	8'	111583	10	Display Tag	•
4"	8'	011436	20	bulk	
	10'	110413	20	bulk	
	20'	110420	25	bulk	
	25'	110421	25	bulk	
	5'	110400	15	bulk	
4"	8'	110454	12	Display Bag	•
	8'	111584	12	Display Tag	•
	8'	110404	12	bulk	
	10'	110414	12	bulk	
	20'	110429	16	bulk	
5"	25'	110419	16	bulk	
	8'	111585	6	Display Tag	•
	8'	110405	6	bulk	
	10'	011440	9	bulk	
	20'	110425	9	bulk	
6"	8'	111586	4	Display Tag	•
	8'	011441	4	bulk	
	10'	110416	12	bulk	
7"	20'	011443	6	bulk	
	8'	111587	4	Display Tag	•
	8'	011444	4	bulk	
8"	10'	110417	8	bulk	
	8'	111588	4	Display Tag	•
	8'	011447	4	bulk	
8"	10'	110418	6	bulk	
	With two steel screw clamps:				
4"	8'	110459	12	Display Bag	•

V730 "DOUBLE FEMALE"



- 8' length
- Aluminum female collars overlap for smooth taped seams.



Diameter	Length	BB Part #	Qty	Package	
3"	8'	011454	20	bulk	
4"	8'	011456	12	bulk	
With two steel screw clamps:					
3"	8'	011501	20	bulk	
4"	8'	011502	12	bulk	

RIGID PIPE & ELBOWS

GALVANIZED PIPE



30 gauge galvanized



Diameter	Length	Part #	Qty	Package
3"	2'	110185	25	bulk
4"	2'	110182	25	bulk
4"	5'	111002	15	bulk

V030 RIGID ALUMINUM PIPE



26 gauge aluminum
(V030 is heavier than V020)



Diameter	Length	Part #	Qty	Package	UPC
3"	2'	110640	25	bulk	•
	5'	110641	15	bulk	
4"	2'	110642	25	bulk	•
	5'	110643	15	bulk	

V020 RIGID ALUMINUM PIPE

Lighter weight than PRO V030

Diameter	Length	Part #	Qty	Package	UPC
3"	2'	110636	25	bulk	•
	5'	110637	15	bulk	
4"	2'	110638	25	bulk	•
	5'	110639	12	bulk	•

V010 RIGID ALUMINUM PIPE

Lightest weight Rigid Pipe

Diameter	Length	Part #	Qty	Package
3"	2'	110644	25	bulk
4"	2'	110645	25	bulk

GALVANIZED ELBOW



- 30 gauge galvanized
- Turns 90° within 6"
 - 4-piece sectional adjustability
 - One crimped end



Diameter	Part #	Qty	Package
3"	110184	12	bulk
	010186	900	skid (75 cases)
4"	110181	12	bulk
	010187	660	skid (55 cases)

ALUMINUM ELBOW

- 26 Gauge
- Turns 90° within 6"
 - One crimped end
 - 4-piece sectional adjustability



Diameter	Part #	Qty	Package	UPC
3"	110543	12	bulk	•
4"	110544	12	bulk	•

LONG SWEEP ELBOW

- Measures the same as straight pipe
- Overcomes length of run issues for some building codes.
- 4-piece sectional adjustability



Diameter	Material	Part #	Qty	Package
4"	aluminum	111646	12	bulk



The Builder's Best® PRO versions are heavier and stronger.

FOIL DUCT AND KITS

FOIL DUCT

UL® 181, Class 1 air connector label

- Multi-ply design of metalized polyester and aluminum/polyester laminate
- Steel wire support
- 3" dia. has 3/4" pitch
- 4–12" dia. has 1" pitch
- UL® sticker every 10 feet
- Maximum velocity rating 5000 fpm



Diameter	Length	Part #	Qty	Package	UPC
3"	8'	110218	12	bulk	
	25'	110201	4	bulk	
	25'	110825	16	bag	
25'	25'	110221	5	ind. box	•
	50'	110215	4	ind. box	•
4"	5'	110219	12	bulk	
	5'	110223	12	Display Box	•
	8'	110224	12	Display Box	•
	8'	110220	12	bulk	
	8'	010242	36	bulk	
	25'	110202	4	bulk	
	25'	110826	16	Bag	
	25'	110222	5	ind. box	•
	50'	110216	4	ind. box	•
	50'	110244	4	Display Box	•
5"	25'	010203	1	ind. box	•
6"	25'	010204	1	ind. box	•
7"	25'	010205	1	ind. box	•
8"	25'	010206	1	ind. box	•
9"	25'	010207	1	ind. box	•
10"	25'	010208	1	ind. box	•
12"	25'	010210	1	ind. box	•
With two spring clamps:					
4"	8'	110680	12	Bag	•
With two steel screw clamps:					
	4"	5'	110660	12	Display Bag •
		8'	110661	12	Display Bag •

FOIL DUCT WALL VENT KITS

Hose	Hood	Clamps	Part #	Qty	Package	UPC
4" x 5' Foil Duct	White wide mouth plastic	2 ZipTorq™	110620	4	ind. box	•
4" x 8' Foil Duct	White wide mouth plastic	2 ZipTorq™	110618	4	ind. box	•
4" x 8' Foil Duct	Standard aluminum	2 ZipTorq™	110533	4	ind. box	•
4" x 5' Foil Duct	Standard aluminum	2 ZipTorq™	110603	4	ind. box	•
4" x 5' Foil Duct	Brown louver plastic	2 ZipTorq™	110611	4	ind. box	•
4" x 5' Foil Duct	White louver plastic	2 ZipTorq™	110612	4	ind. box	•
4" x 8' Foil Duct	Brown louver plastic	2 ZipTorq™	110609	4	ind. box	•
4" x 8' Foil Duct	White louver plastic	2 ZipTorq™	110610	4	ind. box	•
4" x 8' Foil Duct	White louver hood/Incraser/Reducer	2 ZipTorq™	111520	6	Display Box	•

FOIL DUCT ROOF VENT KITS

Hose	Hood	Clamps	Part #	Qty	Package	UPC
4" x 8' Foil Duct	4-5" Plastic Roof Cap/Incraser/Reducer	2 ZipTorq™	011885	1	ind. box	•
4" x 8' Foil Duct	4" Black Metal Roof Cap/Incraser/Reduce	2 ZipTorq™	012640	1	ind. box	•



Part #110533



Part #111520



Part #011885

The Builder's Best® PRO versions are heavier and stronger.



Parts in Red indicate Display Packaging.

SILVERDUCT™ AND KITS

SILVERDUCT™

- UL® listed and labeled as foil dryer transition duct.
- Steel wire support, multi-ply design of aluminum and polyester



Diameter	Length	Part #	Qty	Package	UPC
4"	5'	110504	12	bulk	
	5'	010507	72	bulk	
	5'	110676	6	Display Box	•
8"	110505	12	bulk		
	8"	010508	54	bulk	
	8'	110677	6	Display Box	•
	8'	010793	20	Display Box	•
With two spring tension clamps:					
4"	5'	110670	12	bag	•
	8'	110671	12	bag	•
With two Zip Torq™ clamps:					
4"	5'	110672	12	Display Box	•
	8'	110673	12	Display Box	•

LONG LENGTH SILVERDUCT™

* This product is constructed to meet UL® 2158A transition duct for clothes dryers.

* There is no UL® label. UL® specifies clothes dryer transition duct venting can only be 8 foot in length.

Diameter	Length	Part #	Qty	Package	UPC
4"	20'	111506	6	Display Box	•
	25'	111504	5	ind. box	•
	50'	111505	4	ind. box	•

SILVERDUCT™

DRYER VENT KITS

- 5' and 8' duct is UL® listed and labeled as clothes dryer transition duct.
- Some hoods require assembly
- Louvered hoods and Wide Mouth Plastic hoods have 10" tails

Hose	Hood	Clamps	Part #	Qty	Package	UPC
4" x 5' SilverDuct™	White louvered	2 ZipTorq	111406	6	Display Box	•
4" x 8' SilverDuct™	White louvered	2 ZipTorq	111407	6	Display Box	•
4" x 8' SilverDuct™	White wide mouth bird guard	2 ZipTorq	111408	8	Display Box	•
4" x 8' SilverDuct™	Brown wide mouth bird guard	2 ZipTorq	111528	8	Display Box	•

INDOOR LINT TRAP KITS

Use to vent ELECTRIC (not gas) dryers indoors. Note: We recommend venting dryers to the outside if at all possible.



Description	Clamps	Part #	Qty	Package	UPC
Bucket only		110496	48	bulk	
		110646	9	Display Box	•
Kits include Bucket and:					
4" x 5' SilverDuct™	2 spring	110597	9	Display Box	•
5' V220 Flexible pipe	2 steel	110497	3	ind. box	•



SilverDuct™ UL® 2158A clothes dryer transition duct provides flame resistance. However, it crushes easily behind the dryer and is held together with layers of aluminum foil and polyester plastic.

Clothes dryer manufacturers may limit the use of plastics in venting. Check the dryer warranty and installation instructions as well as your local building codes for appropriate use.

Parts in Red indicate Display Packaging.

VINYL DUCT AND KITS

PRO VINYL HOSE



Thickest Vinyl on the Market.

- steel wire support
- 1" pitch

- * Useful as bathroom fan venting.
- * Not approved for dryer venting.



Diameter	Length	Part #	Qty	Package	UPC
3"	5'	110046	12	bulk	
	8'	111534	12	Display Label	•
	20'	110047	12	bulk	
4"	20'	110048	5	ind. box	•
	50'	110053	4	ind. box	•
	5'	110111	12	bulk	
	8'	110052	12	Display Label	•
	8'	110112	12	bulk	
50'	20'	110059	5	ind. box	•
	50'	110062	4	ind. box	•
	With two ZipTorq™ clamps:				
4"	8'	110653	12	Display Bag	•

STANDARD VINYL HOSE

Steel wire support

- 3¼" and 3" diameter are 1" pitch
- 4" diameter is 1½" pitch

- * Useful as bathroom fan venting.
- * Not approved for dryer venting.
- * Check your local codes.



Diameter	Length	Part #	Qty	Package	UPC
3"	5'	110562	12	bulk	
	8'	110563	12	bulk	
	8'	010558	90	bulk	
	20'	110753	28	bulk	
	20'	110564	5	ind. box	•
3¼"	50'	110565	4	ind. box	•
	20'	110054	28	bulk	
	50'	110055	4	ind. box	•
4"	5'	110566	12	bulk	
	8'	110567	12	bulk	
	8'	010559	72	bulk	
	20'	110568	5	ind. box	•
	50'	110569	4	ind. box	•
	50'	010743	144	skid	

VINYL BATH VENT KITS

For installations which do not require UL® labels, these basic vinyl vent kits meet that need. Vinyl is not suitable for clothes dryer venting.

Hose	Hood	Clamps	Part #	Qty	Package	UPC
4" x 8' Vinyl	Wide mouth aluminum	2 ZipTorq	111522	8	Display Box	•
4" x 8' Vinyl	Brown louvered plastic	2 ZipTorq	111510	6	Display Box	•
4" x 8' Vinyl	White louvered plastic	2 ZipTorq	111511	6	Display Box	•
4" x 8' Vinyl	White wide mouth plastic with bird guard	2 ZipTorq	111517	8	Display Box	•



Part #111522



Part #111511

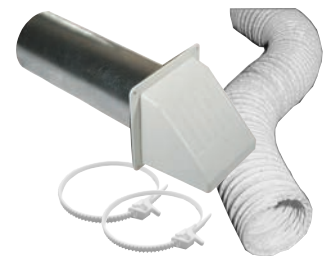

Part #111517

CLEARDUCT™

- Thick PVC (poly-vinyl-chloride) flexible duct
- Durable steel wire supported construction resists crushing and air leakage.

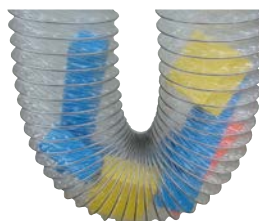

Diameter	Length	Part #	Qty	Package	UPC
4"	8'	100017	12	Display Box	•
50'	25'	110487	9	bulk	
	50'	110509	4	ind. box	•

WALL VENTS - GALVANIZED

GWM088 HEAVY GAUGE HOODS

- 26 Gauge Galvanized
- Riveted, not caulked
- Mouth opening exceeds pipe area
- 4 mounting holes for secure connections

Available:

- With and without backdraft flapper
- With and without 1/4" x 1/4" screens mechanically inserted and removable
- No tailpipe, with 6" tailpipe or with 11" tailpipe.

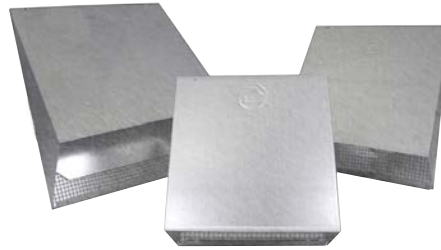

PN 111125

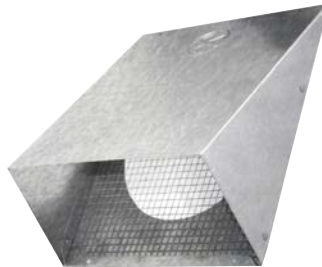

PN 111219



PN 111027

FLAPPER

Diameter	Tail	Part #	Qty
4"	n/a	111201	20
6"		111125	12
11"		011136	12
5"	n/a	111203	12
6"		111127	12
11"		111137	6
6"	n/a	111205	12
6"		111129	12
11"		111139	6
7"	n/a	111207	12
6"		111131	10
11"		111141	6
8"	n/a	111209	12
6"		111132	10
11"		111142	6
10"	n/a	111211	2
6"		111133	2
11"		011143	1
12"	n/a	111213	2
6"		111134	2
11"		011144	1

SCREEN

Diameter	Tail	Part #	Qty
4"	n/a	111215	20
6"		111076	12
11"		011088	12
5"	n/a	111217	12
6"		111078	12
11"		111089	6
6"	n/a	111219	12
6"		111080	12
11"		111091	6
7"	n/a	111221	12
6"		111081	10
11"		111093	6
8"	n/a	111223	12
6"		111082	10
11"		111094	6
10"	n/a	111225	2
6"		111083	2
11"		011095	1
12"	n/a	111227	2
6"		111084	2
11"		011096	1

FLAPPER & SCREEN

Diameter	Tail	Part #	Qty
4"	n/a	111229	20
6"		111033	12
11"		011023	12
5"	n/a	111231	12
6"		111035	12
11"		111024	6
6"	n/a	111233	12
11"		111037	12
n/a		111026	6
7"	n/a	111235	12
6"		111038	10
11"		111027	6
8"	n/a	111237	12
6"		111039	10
11"		111028	6
9"	n/a	111239	2
6"		111040	2
11"		011029	1
10"	n/a	111241	2
6"		111041	2
11"		011030	1



The Builder's Best® PRO versions are heavier and stronger.

WALL VENTS - ALUMINUM

AWM088 HEAVY GAUGE HOODS

- 26 Gauge Aluminum
- Riveted, not caulked
- Mouth opening exceeds pipe area
- 4 mounting holes for secure connections

Available:

- With and without backdraft flapper
- With and without 1/4" x 1/4" screens mechanically inserted and removable
- No tailpipe, with 6" tailpipe or with 11" tailpipe.



PN 111159



PN 111056



PN 111060

FLAPPER

Diameter	Tail	Part #	Qty
4"	n/a	111159	20
6"		111145	12
11"		011148	12
5"	n/a	111161	12
6"		111066	12
11"		111097	6
6"	n/a	111163	12
6"		111068	12
11"		111099	6
7"	n/a	111165	12
6"		111070	10
11"		111101	6
8"	n/a	111167	12
6"		111071	10
11"		111102	6
10"	n/a	111169	2
6"		111072	2
11"		011103	1
12"	n/a	111171	2
6"		111073	2
11"		011104	1

SCREEN

Diameter	Tail	Part #	Qty
4"	n/a	111173	20
6"		111115	12
11"		011106	12
5"	n/a	111175	12
6"		111117	12
11"		111107	6
6"	n/a	111177	12
6"		111119	12
11"		111109	6
7"	n/a	111179	12
6"		111121	10
11"		111111	6
8"	n/a	111181	12
6"		111122	10
11"		111112	6
10"	n/a	111183	2
6"		111123	2
11"		011113	1
12"	n/a	111185	2
6"		111124	2
11"		011114	1

FLAPPER & SCREEN

Diameter	Tail	Part #	Qty
4"	n/a	111187	20
6"		111056	12
11"		011046	12
5"	n/a	111189	12
6"		111058	12
11"		111047	6
6"	n/a	111191	12
6"		111060	12
11"		111049	6
7"	n/a	111193	12
6"		111062	10
11"		111050	6
8"	n/a	111195	12
6"		111063	10
11"		111051	6
10"	n/a	111197	2
6"		111064	2
11"		011052	1
12"	n/a	111199	2
6"		111065	2
11"		011053	1

AWM088 6" HOOD WITH SPRING LOADED DAMPER

- Aluminum
- Back draft spring-loaded damper



Diameter	Tail	Part #	Qty	Package	UPC
6"	6"	111387	12	bulk	
6"		011641	1	ind. box	•
6"	2 3/4"	111906	8	bulk	
Faceplate only:					
6"	n/a	111811	12	bulk	

WALL VENTS - GALVANIZED

GWM271 P-TANIUM™ WIDE MOUTH HOOD

- Ships gray, ready to paint
- 1 1/2" tailpipe
- Back-draft flapper

Paintable galvanized finish ships as gray, but accepts standard house paint.



PN 110889



PN 111157

Diameter	Part #	Qty	Package	UPC
----------	--------	-----	---------	-----

Wide Mouth:

3"	110887	12	bulk	•
4"	110648	6	Display Tray	•
	111430	8	Display Card	•
	110889	12	bulk	

Wide Mouth with flapper, screen and tail:

4"	110891	12	bulk	
----	--------	----	------	--

Hood only, no tailpipe:

Wide Mouth:

4"	111157	24	bulk	
----	--------	----	------	--

P-Tanium™ Trim Plates

3"	110056	100	bulk	
4"	110057	100	bulk	

GSM277 P-TANIUM™ STANDARD MOUTH HOOD

- Ships gray, ready to paint
- 1 1/2" tailpipe
- Back-draft flapper



PN 110885

Diameter	Part #	Qty	Package	UPC
----------	--------	-----	---------	-----

Standard Mouth:

3"	110883	12	bulk	
4"	110885	12	bulk	•
	110750	4	ind. box	•

Hood only, no tailpipe:

Standard Mouth:

4"	111419	24	bulk	
----	--------	----	------	--

GSM277 P-TANIUM™ AIR INTAKE

- Intakes do not have flappers
- Grid is metal 1/4" x 1/4"
- 1 1/2" Tailpipe
- P-Tanium™ paintable galvanized finish



Diameter	Part #	Qty	Package	UPC
----------	--------	-----	---------	-----

4"	110729	12	bulk	
----	--------	----	------	--

GWM271 SPANGLED WIDE MOUTH HOOD

- 1 1/2" tailpipe
- Back-draft flapper



PN 110771

Diameter	Part #	Qty	Package	UPC
----------	--------	-----	---------	-----

Wide mouth:

3"	110770	12	bulk	
4"	110771	12	bulk	

No tail wide mouth:

4"	110699	24	bulk	
----	--------	----	------	--

GSM277 SPANGLED STANDARD MOUTH HOOD

- 1 1/2" tailpipe
- Back-draft flapper

Diameter	Part #	Qty	Package	UPC
----------	--------	-----	---------	-----

Standard mouth:

4"	110732	12	bulk	
----	--------	----	------	--



The Builder's Best® PRO versions are heavier and stronger.

Parts in Red indicate Display Packaging.

WALL VENTS - ALUMINUM

AWM271 WIDE MOUTH HOOD

- 1 1/2" tailpipe
- Back plate
- Back-draft flapper
- Fully assembled, riveted tailpipe



PN 110271

Diameter	Part #	Qty	Package	UPC
3"	110270	12	bulk	•
3"	110328	4	ind. box	•
4"	110170	6	Display Tray	•
	110271	12	bulk	•
	110326	4	ind. box	•
With 4" tailpipe:				
4"	110791	18	bulk	
Faceplate only:				
4"	110557	24	bulk	
Faceplate with Flapper and Screen (no tailpipe):				
4"	110786	24	bulk	
With tail, flapper and screen:				
4"	110684	12	bulk	

ASM277 STANDARD MOUTH HOOD

- 1 1/2" tailpipe
- Back plate
- Back-draft flapper
- Fully assembled, riveted tailpipe

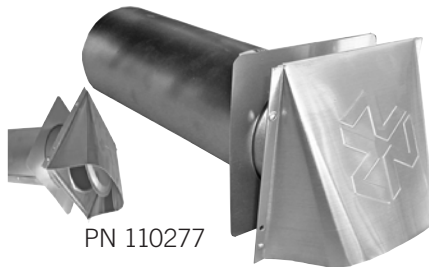

PN 110277

Standard Mouth:				
3"	110276	12	bulk	•
	110278	4	ind. box	•
4"	110277	12	bulk	•
	110279	4	ind. box	•

ARR929 RECTANGULAR HOODS

- 3 1/4" x 10" long rectangular tail
- Back draft spring-loaded
- Foam damper seals for quiet closure



Tail	Color	Part #	Qty	Package	UPC
Aluminum ARR929:					
5"		111929	14	bulk	•
11"		111377	8	bulk	•
Primex WC:					
1 1/4"	Gray	111872	6	bulk	
1 1/4"	White	111873	6	bulk	

WC310 primex

- UV Stabilized polymer resin
- 3 1/4" x 10" x 1 1/4" long rectangular tail
- Removable damper for intake or exhaust
- 1/2" x 1/2" molded grid
- Drip edge on flanged base to help drain away water



Parts in Red indicate Display Packaging.

WALL VENTS - PLASTIC

SM primex[®] SIDE WALL CAP

- UV-stabilized durable polymer resin
- One-piece, seamless design helps eliminate leaky joints while maximizing water protection
- Spring loaded damper reduces noise caused by wind
- Removable screen

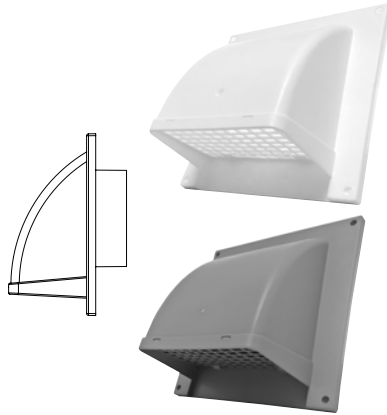

Diameter	Part #	Qty	Package	color	UPC
4"	112291	24	bulk	white	
5"	112292	10	bulk	white	
6"	112293	10	bulk	white	
6"	012303	1	Display Box	white	•
4"	112294	24	bulk	gray	
5"	112295	10	bulk	gray	
6"	012287	1	Display Box	gray	•
6"	112296	10	bulk	gray	
4"	112297	24	bulk	brown	
5"	112298	10	bulk	brown	
6"	112299	10	bulk	brown	

WC & WCL primex[®] WALL CAPS

- UV stabilized polymer resin
- Drip edge on flanged base helps drain away water
- Removable damper
- ½" x ½" molded grid
- Intake or Exhaust

* Other colors available upon request. Lead times will vary.



WC
Regular Profile

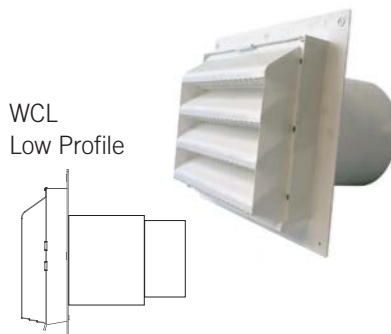
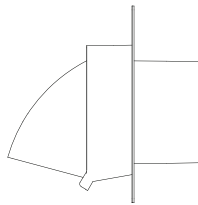

WCL
Low Profile

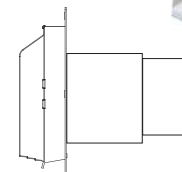

Diameter	Part #	Qty	Package
WC Regular Profile			
White:			
4"	111775	4	bulk
5"	111776	4	bulk
6"	111777	4	bulk
7"	111778	2	bulk
Gray:			
4"	111781	4	bulk
5"	111782	4	bulk
6"	111783	4	bulk
7"	111784	2	bulk
Brown:			
4"	111833	4	bulk
5"	112073	4	bulk
6"	111835	4	bulk
7"	112080	2	bulk

Diameter	Part #	Qty	Package
WCL Low Profile - Louvered:			
White:			
7" or 8"	111867	4	bulk
Gray:			
7" or 8"	111752	4	bulk

J-BLOCK VENT HOOD

- Plastic hood for brick, siding & stucco applications
- Weighted design helps prevent wind noise and animal entry.
- 11" tailpipe included
- 7.5" wide by 8.5" tall face
- Made in Canada



Diameter	Color	Part #	Qty	Package
With 11" Tailpipe:				
Reversible trim ring adjusts from 0 to ½":				
4"	White	111705	12	bulk
	Brown	111712	12	bulk
Reversible trim ring adjusts from ½" to 1.15":				
4"	White	111706	12	bulk
	Brown	111713	12	bulk
Faceplates only:				
Reversible trim ring adjusts from 0 to ½":				
4"	White	111714	12	bulk
	Brown	111715	12	bulk
Reversible trim ring adjusts from ½" to 1.15"				
4"	White	111716	12	bulk
	Brown	111717	12	bulk

WALL VENTS - PLASTIC WIDE MOUTH

PWM113 WIDE MOUTH HOOD

- 11" fully assembled, riveted tailpipe
- Aluminum trim plate
- Back-draft flapper
- Wide mouth plastic hood

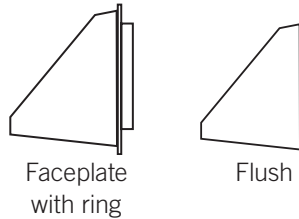

Diameter	Color	Part #	Qty	Package	UPC
3"	White	111243	8	bulk	•
	Brown	111378	8	bulk	•
4"	White	010179	6	Display Tray	•
	White	110164	8	Display Card	•
	White	110113	8	bulk	•
	White	110330	4	ind. box	•
	Brown	110410	8	Display Card	•
	Brown	110177	6	Display Tray	•
	Brown	110284	8	bulk	•
	Brown	110332	4	ind. box	•
Faceplate with ring:					
3"	White	111373	8	bulk	
	Brown	111374	8	bulk	
4"	White	110119	8	bulk	
	White	010723	336	skid (gaylord)	
	Brown	110285	8	bulk	
	Brown	010724	336	skid (gaylord)	
Faceplate for flush installation (no ring):					
4"	White	110766	8	bulk	
	White	010768	392	skid (gaylord)	
	Brown	110767	8	bulk	
	Brown	010769	392	skid (gaylord)	

PWM113 BIRD GUARD HOOD

- 11" fully assembled, riveted tailpipe
- Aluminum trim plate
- Back-draft flapper
- Wide mouth plastic hood
- ½" x ½" pest grid
- Snaps in and removable for cleaning.

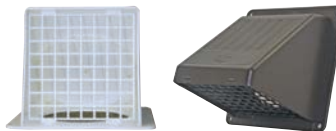

* This hood is not recommended for dryer venting, but if so used, check screen frequently for lint build-up.

Diameter	Color	Part #	Qty	Package	UPC
3"	White	111365	8	bulk	
	Brown	111368	8	bulk	
4"	White	111381	8	bulk	
	White	111411	6	Display Tray	•
	Brown	111384	8	bulk	
Faceplate with ring:					
3"	White	111375	8	bulk	
	Brown	111376	8	bulk	
4"	White	111732	8	bulk	
	Brown	111733	8	bulk	
Faceplate for flush installation (no ring):					
4"	White	111391	8	bulk	
	Brown	111392	8	bulk	

PEST GUARD

- Universal cap fits over most thru wall vent hoods
- Hinge action allows for easy cleaning.
- This product is made in Canada.



Color	Part #	Qty	Package	UPC
Fits over most 4" diameter through wall hoods				
White	111572	12	bulk	
	111573	12	Display Label	

Parts in Red indicate Display Packaging.

WALL VENTS - PLASTIC LOUVERED

PML282 LOUVERED PLASTIC HOOD WITHOUT TAILPIPE

- Screens are 1/4" x 1/4" molded grid
- Hoods with screens are not recommended for dryer venting.



snap-on connecting ring

SNAP ON RING

Diameter	Color	Part #	Qty	Package
3"	White	110749	12	bulk
	Brown	110872	12	bulk
4"	White	111424	12	Display Card
		110286	12	bulk
4"	Brown	111545	12	Display Card
		110287	12	bulk
5"	White	110830	12	bulk
	Brown	110834	12	bulk
6"	White	110838	12	bulk
	Brown	110842	12	bulk
7"	White	110846	12	bulk
	Brown	110850	12	bulk
8"	White	110854	12	bulk
	Brown	110858	12	bulk

RING WITH SCREEN

Diameter	Color	Part #	Qty	Package
3"	White	110340	12	bulk
	Brown	110342	12	bulk
4"	White	110288	12	bulk
	Brown	110292	12	bulk
5"	White	110831	12	bulk
	Brown	110835	12	bulk
6"	White	110839	12	bulk
	Brown	110843	12	bulk
7"	White	110847	12	bulk
	Brown	110851	12	bulk
8"	White	110855	12	bulk
	Brown	110859	12	bulk



flush



with screen

FLUSH

Diameter	Color	Part #	Qty	Package
3"	White	111149	24	bulk
	Brown	111151	24	bulk
4"	White	111153	24	bulk
	Brown	111155	24	bulk
5"	White	110832	12	bulk
	Brown	110836	12	bulk
6"	White	110840	12	bulk
	Brown	110844	12	bulk
7"	White	110848	12	bulk
	Brown	110852	12	bulk
8"	White	110856	12	bulk
	Brown	110860	12	bulk

FLUSH WITH SCREEN

Diameter	Color	Part #	Qty	Package
4"	White	110291	24	bulk
	Brown	110294	24	bulk
5"	White	110833	12	bulk
	Brown	110837	12	bulk
6"	White	110841	12	bulk
	Brown	110845	12	bulk
7"	White	110849	12	bulk
	Brown	110853	12	bulk
8"	White	110857	12	bulk
	Brown	110861	12	bulk

PML282 LOUVERED PLASTIC HOOD WITH TAILPIPE

- 11" tailpipe
- Aluminum trim plate
- Fully assembled
- Faceplate has 4 louvers

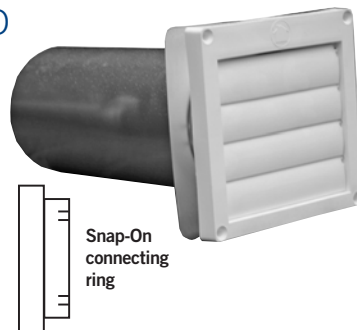

Snap-On connecting ring

Diameter	Color	Part #	Qty	Package	UPC
3"	White	110280	12	bulk	
	White	110334	4	ind. box	•
	Brown	110281	12	bulk	
4"	White	111412	12	Display Card	•
	White	110282	12	bulk	•
	White	110336	4	ind. box	•
4"	Brown	111414	12	Display Card	•
	Brown	110283	12	bulk	•
	Brown	110338	4	ind. box	•
Unassembled:					
4"	White	111692	12	bulk	
	Brown	111734	12	bulk	
Louver replacements					
4"	White	110003	100	bulk	
	Brown	110004	100	bulk	

EAVE VENTS - ALUMINUM

AEV199

FRESH AIR INTAKE

- Aluminum construction
- Intakes do not have flappers, meeting IBC.
- Grid is metal 1/4" x 1/4" , with 1/4" round holes
- Female snap-lock collar



Diameter	Part #	Qty	Package
Fresh air intake:			
4"	110189	8	bulk

AEV199

SCREENED EXHAUST

- Back draft flapper
- Aluminum construction
- Grid is metal 1/4" x 1/4" , with 1/4" round holes



Diameter	Part #	Qty	Package
Exhaust with flapper and female snap-lock™ fitting:			
4"	110188	8	bulk
Exhaust with flapper and male snap-lock™ fitting:			
4"	110199	8	bulk

AEV199

DRYER EAVE VENT

NO SCREEN

- 4" collar
- Back draft flapper
- No screen per IBC building codes
- Installs flush with eave



Description	Part #	Qty	Package	UPC
Female snap-lock collar	110166	8	Display Card	•
	110139	8	bulk	
Male crimped collar	110200	8	bulk	

* Good for clothes dryer venting.

AFL535

MICRO LOUVER EAVE VENT

- Aluminum
- Fixed louvered screen
- Installs flush

* This versatile eave vent is good for bathroom fan venting or fresh air intakes. Formerly the "Pro-Vent™ Eave Vent".



Diameter	Part #	Qty	Package
Faceplate only:			
3"	110272	20	bulk
4"	110273	20	bulk
With 3 ft V230 flexible aluminum pipe:			
3"	110274	16	bulk
4"	110275	16	bulk
With 3" collar:			
3"	110556	8	bulk
4"	110555	8	bulk

Parts in Red indicate Display Packaging.

EAVE VENTS - PLASTIC

PFL812 MINI LOUVER

- Polypropylene molded plastic
- Screens are ¼" x ¼" molded grid
- Fixed louvers
- 4 mounting holes
- Works for thru-wall as well as eave venting



PN 110681



PN 110812

FLUSH MOUNT

Diameter	Color	Part #	Qty
3"	White	110975	12
	Brown	110976	12
4"	White	110751	12
	Brown	110752	12
5"	White	110896	12
	Brown	111005	12
6"	White	110900	12
	Brown	111503	12
7"	White	110904	12
	Brown	111013	12
8"	White	110908	12
	Brown	111017	12



flush

FLUSH WITH SCREEN

Diameter	Color	Part #	Qty
5"	White	110897	12
	Brown	111006	12
6"	White	110901	12
	Brown	111010	12
7"	White	110905	12
	Brown	111014	12
8"	White	110909	12
	Brown	111018	12

WITH 3" TAIL

Diameter	Color	Part #	Qty
3"	White	110695	12
	Brown	110681	12
4"	White	110812	12
	Brown	110519	12

WITH 4" TAIL

Diameter	Color	Part #	Qty
6"	White	111918	4

WITH 10" TAIL

Diameter	Color	Part #	Qty
3"	White	110893	12
	Brown	110683	12
4"	White	110813	12
	Brown	110971	12

SNAP ON RING

Diameter	Color	Part #	Qty
3"	White	110694	12
	Brown	110682	12
4"	White	110811	12
	Brown	110972	12
5"	White	110894	12
	Brown	111003	12
6"	White	110898	12
	Brown	111007	12
7"	White	110902	12
	Brown	111011	12
8"	White	110906	12
	Brown	111015	12



snap-on
connecting ring

RING & SCREEN

Diameter	Color	Part #	Qty
4"	White	110754	12
	Brown	110974	12
5"	White	110895	12
	Brown	111004	12
6"	White	110899	12
	Brown	111008	12
7"	White	110903	12
	Brown	111012	12
8"	White	110907	12
	Brown	111016	12



PN 111249

WITH 3' FLEX TAIL

Diameter	Color	Part #	Qty
3"	White	111251	12
	Brown	110977	12
4"	White	111249	12
	Brown	110973	12

PEV802 - EXHAUST

- Polypropylene molded plastic
- Pre-drilled mounting holes
- Back draft flapper
- Locking ring connection on back
- Available with ¾" connecting ring OR 3" long aluminum tail
- Can be used for bathroom fan or dryer vent



Diameter	Color	Part #	Qty	Package	UPC
With ¾" connecting ring:					
3"	White	111830	12	bulk	
	Brown	111831	12	bulk	
4"	White	111802	12	bulk	
	Brown	111803	12	bulk	
With 3" long aluminum tail:					
3"	White	111806	12	bulk	
	Brown	111807	12	bulk	
4"	White	111804	12	bulk	•
	Brown	111805	12	bulk	•

EAVE VENTS - PLASTIC

SV EXHAUST primex

- One piece design
- No leaky seams
- Made from UV stabilized polymer resin
- Back draft flapper

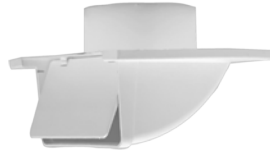

Diameter	Color	Part #	Qty	Package
4"	White	111858	12	bulk
5"	White	111859	12	bulk
6"	White	112251	10	bulk

SV28 EXHAUST primex

- One piece design
- No leaky seams
- Made from UV stabilized polymer resin
- Back draft flapper



PN 111941
shown with optional adapter PG 26

Diameter	Color	Part #	Qty	Package
4"-8" Flush (adapters on page 26):				
4"-8"	White	111941	6	bulk screen
4"-8"	White	111942	6	bulk no screen

RDV primex

- Extra long collar for better duct connection
- Molded in mesh screen
- UV Stabilized polymer resin
- Secure friction fit



Diameter	Color	Part #	Qty	Package	UPC
2"	White	111852	50	bulk	•
4"	White	111869	16	bulk	•
5"	White	111870	50	bulk	•
6"	White	111871	12	bulk	•

CEILING DIFFUSERS

WG primex

ADJUSTABLE DIFFUSERS

- Dual flow for intake or exhaust
- Stainless steel grip "clip" for snug fit
- Foam gasket allows for tight seal on uneven surfaces
- Lock nut included to adjust air flow



Diameter	Part #	Qty	Package
4"	111862	12	bulk
5"	111864	12	bulk
6"	111865	8	bulk

WGX primex

ADJUSTABLE DIFFUSERS

- Dual flow for intake or exhaust
- Adjustment screw to set airflow
- Secure friction fit
- Trim ring snaps over flange and hides mounting screws



Diameter	Part #	Qty	Package
4"	111896	25	bulk
6"	111898	25	bulk
8"	111900	15	bulk

Builder's Best is an Authorized Primex Distribution Partner.
Primex is Made in Canada.



ACCESSORIES

STEEL TENSION CLAMPS

- "Spring" clamps
- No tools required



Diameter	Part #	Qty	Package	UPC
3"	110480	100	bulk	
4"	111551	25	Display Card	
	110482	100	bulk	

WORM GEAR CLAMPS

- Galvanized
- Plated steel band, housing and screw



Diameter	Part #	Qty	Package	UPC
3"	111908	100	bulk	
4"	111909	100	bulk	
	111546	25	Display Card	•
6"	111911	40	bulk	

STEEL SCREW CLAMPS

- 1½" Phillips/hex head steel screw
- 4" Minimum I.D. 3.90", Max 4¼"
- Designed to resist stretching.



Diameter	Part #	Qty	Package	UPC
3"	110065	100	bulk	
4"	110074	25	Display Card	•
	110071	100	bulk	
6"	111417	40	bulk	
2" screw (provides larger diameter)				
4"	110075	100	bulk	

* 110074 display is 2 clamps per card, 25 cards per case.

ZIP TORQ™ CLAMPS

- Unique polymeric stretch plastic
- Tightens without tools
- Loosens with #2 phillips screwdriver



Diameter	Part #	Qty	Package	UPC
3"-4"	112145	100	bulk	

PLASTIC RATCHET CLAMPS

- Releasable Cable Tie
- Press tab, release and reuse.



Diameter	Part #	Qty	Package	UPC
3"-4"	111423	25	Display Card	•

11" ALUMINUM TAILPIPES

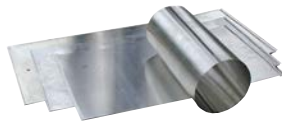

Diameter	Part #	Qty	Package	UPC
3"	110866	24	bulk	
4"	110867	24	bulk	
5"	110862	24	bulk	
6"	110863	24	bulk	
7"	110864	24	bulk	
8"	110865	24	bulk	

FOIL TAPE

- Aluminum foil printed backing
- Acrylic adhesive
- Paper liner
- Aluminum color
- Used to seal connections

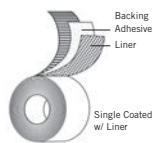

Description	Part #	Qty	Package
2.5" x 60 yards	111704	16	bulk

Parts in Red indicate Display Packaging.

ACCESSORIES

DRAFT STOPPER

- Helps prevent cold air from entering home through clothes dryer by inserting between clothes dryer duct and wall pipe.



Diameter	Part #	Qty	Package	UPC
4"	111577	6	bulk	

DRYER HEAT DIVERTER

- * Manual control directs heat into home in cold weather or outside in warm weather.



Diameter	Part #	Qty	Package	UPC
4"	111575	6	bulk	

ALUMINUM TRIM PLATES



Diameter	Part #	Qty	Package	UPC
3"	110126	100	bulk	
4"	110122	100	bulk	

WINDOW PLATE

- 12" high by 18" wide Aluminum



Description	Part #	Qty	Package	UPC
3" opening	110494	25	bulk	
4" opening	110495	25	bulk	

INCREASER & REDUCER

- Connect ducts of different diameters.

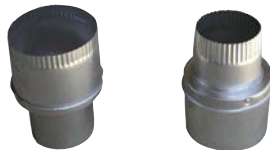

Part #110493 Part # 110492

Description	Part #	Qty	Package	UPC
Aluminum increaser 3" to 4"	110493	12	bulk	•
Aluminum reducer 4" to 3"	110492	12	bulk	•



Part # 110290

Description	Part #	Qty	Package	UPC
Plastic increaser/reducer 3"/4"	110290	10	bulk	•

DUCT COUPLING

- Aluminum coupling to connect pieces of pipe.



Part #110490, #110491 & #111536 Part #110137

Description	Diameter	Length	Part #	Qty	Package	UPC
Crimped both ends:						
Aluminum	3"	3"	110490	12	bulk	•
	4"	3"	110491	12	bulk	•
	6"	3"	111536	6	bulk	•
One end crimped, one end beaded:						
Aluminum	4"	3"	110137	25	bulk	

DUCT COUPLING



- Galvanized coupling
- Connect pieces of pipe



Part #111690

Description	Diameter	Length	Part #	Qty	Package	UPC
Galvanized	3"	4"	111689	16	bulk	
	4"	4"	111690	9	bulk	
	6"	4"	111691	4	bulk	

ROOF VENT CAPS

Builder's Best metal roof vent caps are rugged, high capacity terminations for bathroom and kitchen fans. Screens are removable so that caps can be used for venting clothes dryers as well. The GRV635 Black galvanized roof cap is treated with high performance polyester powder. At right are the results of the ASTM B117 testing and this roof cap shows very little corrosion.



Builder's Best coated galvanized steel



Leading Brand painted cold rolled steel

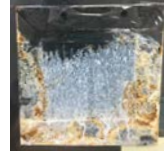

Foreign brand painted galvanized steel

GRV635 BLACK



- 26 gauge galvanized steel
- Black powder coat finish
- Removable 1/4" x 1/4" screen
- Back draft flapper
- Available with 4" collar and flush



012635



012636

Kit #012640 includes:

- One black roof cap with 4" diameter collar
- One 4" diameter x 8' UL® 181 Foil Duct
- One 3-4" Plastic Increaser/Reducer
- Two plastic Zip Torq™ clamps

Diameter	Part #	Qty	Package	Opening	UPC
4"	012635	1	Ind. Box	with collar	•
	012645	1	Disp. Box	with collar	•
	012636	1	Ind. Box	flush	•
	012646	1	Disp. Box	flush	•
no screen	012642	1	Ind. Box	flush	•
no screen	012643	1	Ind. Box	with collar	•
6"	012632	1	Ind. Box	flush	•
6"	012633	1	Ind. Box	with collar	•
7"	012639	1	Ind. Box	with collar	•
6-8" (3 1/4" x 10")	012634	1	Ind. Box	flush	•
	4" Black Kit 012640	1	Disp. Box	with collar	•

GRV635 SPANGLED



- 26 gauge bright spangled galvanized
- Removable 1/4" x 1/4" screen
- Back-draft flapper
- Available with 4" collar and flush



011756



011772

Diameter	Part #	Qty	Package	Opening	UPC
4"	011755	1	Ind. Box	flush	•
	011756	1	Ind. Box	with collar	•
no screen	012120	1	Ind. Box	flush	•
no screen	012121	1	Ind. Box	with collar	•
6"	011793	1	Ind. Box	flush	•
	011794	1	Ind. Box	with collar	•
6-8" (3 1/4" x 10")	011772	1	Ind. Box	flush	•
7"	011773	1	Ind. Box	flush	•
	011868	1	Ind. Box	with collar	•
10"	011774	1	Ind. Box	flush	•

ARV635 ALUMINUM



- 24 gauge aluminum
- Removable 1/4" x 1/4" screen
- Back draft flapper
- Available with 4" collar and flush



011748



011754

Diameter	Part #	Qty	Package	Opening	UPC
4"	011748	1	Ind. Box	flush	•
	011749	1	Ind. Box	with collar	•
no screen	011751	1	Ind. Box	flush	•
no screen	011746	1	Ind. Box	with collar	•
6"	011795	1	Ind. Box	flush	•
	011796	1	Ind. Box	with collar	•
6-8" (3 1/4" x 10")	011754	1	Ind. Box	flush	•
7"	011747	1	Ind. Box	flush	•
	011753	1	Ind. Box	with collar	•

Parts in Red indicate Display Packaging.

ROOF VENT CAPS

UMBRELLA CAP™

- Galvanized steel construction
- Rigid ribbed construction
- Economical protection from rain and snow for flues and vent pipes



Diameter	Cap diameter	Qty	Part #	UPC
3"	8"	1	010957	•
4"	8"	1	010958	•
5"	12"	1	010959	•
6"	12"	1	010960	•
7"	12"	1	010961	•
8"	12"	1	010962	•
9"	17"	1	010963	•
10"	17"	1	010964	•
12"	17"	1	010965	•

CREATIVE CROWN VENT CAP

- Galvanized steel construction for corrosion resistance
- Designed to effectively evacuate fumes from flues or pipes
- Eliminates downdrafts
- May also be used as a storm-proof air intake or exhaust
- Riveted assembly for long life



Diameter	Head diameter	Height	Part #	UPC
3"	7.63"	7"	010921	•
4"	7.63"	7"	010922	•
5"	9"	7.5"	010923	•
6"	10.5"	9"	010924	•
7"	12.25"	10.5"	010925	•
8"	14.13"	11.25"	010926	•
9"	16.5"	11.5"	010927	•
10"	18.5"	12.5"	010928	•
12"	22.5"	14.5"	010929	•

BROAD BAND SIPHON VENTILATOR™

- Rugged galvanized steel to guard against rust
- Large unrestricted outlet
- Storm proof – prevents downdrafts
- Ribbed cap and wide band provide maximum protection from the weather and create a strong siphoning action



Collar	5mph wind	Overall	Height	Part #	UPC
3"	2500	11"	6"	010939	•
4"	3000	11"	6"	010940	•
5"	3500	15"	7.5"	010941	•
6"	4000	15"	7.5"	010942	•
7"	5200	15"	7.5"	010943	•
8"	6500	15"	7.5"	010944	•
9"	7500	20"	10"	010945	•
10"	8400	20"	10"	010946	•
12"	9600	20"	10"	010947	•

ROOF VENT CAPS

RV28 GOOSENECK primex[®]

- UV protected polymer resin
- One piece, seamless construction
- Removable screen
- Removable backdraft damper
- ½" x ½" molded grid
- 4" thru 8" snap-in adapters available separately
- 26.5 square inches mouth opening



Diameter	Part #	Qty
Black roof cap only:		
4" - 8"	111786	5

ROOF CAP ADAPTER

- Snap fits with Plastic Gooseneck (above) & Heavy Duty Low Profile (below)
- Also for use with Premium Eave Vent on Page 21



Diameter	Part #	Qty
Black Adapters:		
4"	111787	8
5"	111788	8
6"	111789	8
7"	111790	6
8"	111791	6

RVL28 primex[®]

- UV protected polymer resin
- One piece, seamless construction
- Removable screen
- Removable backdraft damper
- ½" x ½" molded grid
- 4" thru 8" snap-in adapters available separately
- 27.8 square inch mouth opening



Diameter	Part #	Qty
Black roof cap only:		
4" - 8"	111797	6

RV20 primex[®]

- 20 sq. inches of "free area"
- One piece molded hood maximizes protection from leaks
- Fixed screen
- Removable damper
- UV protected polymer resin
- 6.5" x 6.88" x 4.88"



Diameter	Part #	Qty	Opening
4" - 5" - 6"	111866	10	collar

DURAFLO[®] ROOF CAP

- Heavy duty black plastic (polypropylene), modified for impact and UV resistance
- Flexible flange
- Molded screen
- Unique chatterless flapper
- Available flush mount or with a 3" long collar which adapts to 4" & 5" pipe
- Exhausts dryer vents or bathroom fan vents thru the roof.
- Made in Canada

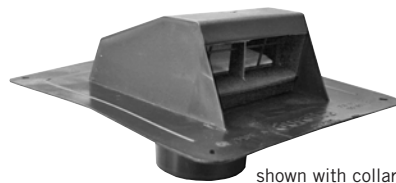

shown with collar

Diameter	Part #	Qty	Opening	UPC
Dryer Vent:				
4" - 5"	111250	6	collar	
up to 5"	111507	4	flush	
Bathroom Vent:				
4" - 5"	111508	6	collar	
up to 5"	111509	4	flush	
Bathroom Vent Kit with collar, 8' foil, increaser/reducer and clamps				
4" - 5"	011885	1	collar	•

SAF-T-DUCT® ELBOWS

CLOSE ELBOW®



- Turns 90° within 4"
- One male rotating snap-lock™ collar
- One female rotating snap-lock™ collar
- Best choice for 90° turns, especially on the dryer.

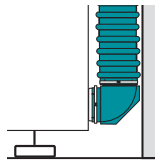

Diameter	Part #	Qty	Package	UPC
4"	110161	6	Display Card	•
	010151	24	Display Card	•
	110108	24	bulk	

WALL OFFSET ELBOW®



- Turns 90° within 4"
- One male rotating snap-lock™ collar
- One female snap-lock™ collar
- Use when outlet pipe in wall protrudes up to 2.5" and cannot be trimmed.

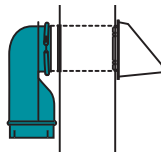

Diameter	Part #	Qty	Package	UPC
4"	110162	4	Display Card	•
	010152	20	Display Card	•
	110109	20	bulk	

DRYER OFFSET ELBOW®



- Turns 90° within 4"
- One female rotating snap-lock™ collar
- One male snap-lock™ collar
- Use when outlet pipe on dryer protrudes up to 2.5" and cannot be trimmed.
- Can also be used on wall outlet pipe if pipe is too large for Wall Offset Elbow®

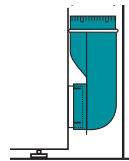

Diameter	Part #	Qty	Package	UPC
4"	110165	4	Display Card	•
	010155	20	Display Card	•
	110110	20	bulk	

Parts in Red indicate Display Packaging.

Clearance behind dryer • SPACE SAVINGS

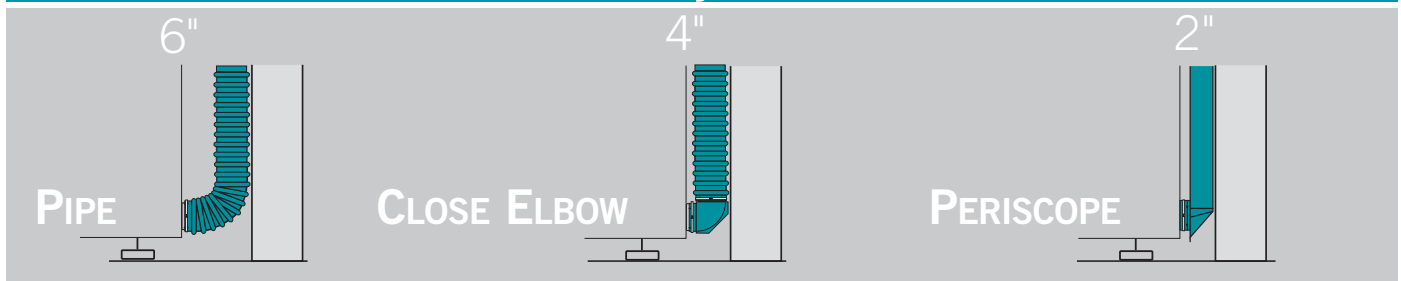

SAF-T-DUCT® Dryer Venting is the trusted solution for professional installers nationwide. These parts are available in several retail programs. It meets all clothes dryer manufacturer specifications. Heavy duty aluminum, Snap-Lock™ fittings, unique elbows and periscopes round out this line.



SAF-T-DUCT® SEMI-RIGID ALUMINUM DUCT

V830 BUILDER'S BEST®

- Best choice for dryer venting
- 4" Aluminum Snap-Lock™ Fittings

Builder's Best® Flexible Pipe is designed to snap-lock™ to elbows or to other pieces of V830 for longer runs.



Diameter	Length	Part #	Qty	Package	UPC
4"	6'	110129	12	Display Bag	•
	6'	010016	12	Display Tray	•
	5'	110138	15	bulk	
	6'	110107	12	bulk	
	8'	110120	20	bulk	
	12'	110079	20	bulk	
With two steel screw clamps:					
4"	6'	110092	12	bulk	

V530 E-Z-FASTEN™

- 4" Aluminum Male Snap-Lock Fitting
- One soft-cuff end



Diameter	Length	Part #	Qty	Package	UPC
4"	5'	110130	5	Display Bag	•
	5'	010150	15	Display Bag	•
	5'	110105	15	bulk	
	8'	110180	20	bulk	
E-Z-Fasten™ Shortie™ includes one steel screw clamp:					
4"	2'	110160	30	bulk	

V430 READI-PIPE™

- 4" aluminum soft cuff both ends
- Soft cuff ends are ready to clamp to other components.



Diameter	Length	Part #	Qty	Package	UPC
4"	4'	110088	20	bulk	
	5'	110089	15	bulk	
	6'	110090	12	bulk	
	8'	110091	12	bulk	
4" x 8' Read-PIPE™ Display Bag includes two steel clamps:					
4"	8'	110131	12	Display Bag	•

EXTENSION COLLAR

- 4" diameter x 3" aluminum collar
- Snap-lock fittings



Diameter	Length	Part #	Qty	Package
4"	3"	110103	25	bulk

MONEY SAVINGS with All Metal Venting

<p>ENHANCED DRYER EFFICIENCY AND LIFESPAN</p> 	<p>MEETS DRYER MANUFACTURER RECOMMENDATIONS</p> 	<p>FLAME RESISTANT ALL METAL CONSTRUCTION</p> 
--	---	--

Parts in Red indicate Display Packaging.



SAF-T-DUCT® Dryer Venting is the trusted solution for professional installers nationwide. These parts are available in several retail programs. It meets all clothes dryer manufacturer specifications. Heavy duty aluminum, Snap-Lock™ fittings, unique elbows and periscopes round out this line.

SAF-T-DUCT® SEMI-RIGID ALUMINUM DUCT

V450-TD BUILDER'S BEST®

- One male snap-lock™ crimped fitting
- One female snap-lock™ slotted fitting
- 4" diameter
- 6' length compressed to approx 30"



Diameter	Length	Part #	Qty	Package
Builder's Best® UL®				
4"	6'	110548	12	bulk
E-Z-Fasten™ UL®				
4"	8'	110546	12	bulk
Readi-Pipe™ UL®				
4"	6'	111700	12	bulk
	8'	110545	12	bulk
Plain End UL®				
4"	8'	110592	12	bulk

V450-TD E-Z-FASTEN™

- One male snap-lock™ crimped fitting
- One soft-cuff slotted end
- 4" diameter
- 8' length compressed to approx 30"



V450-TD READI-PIPE™

- both ends are slotted soft cuffs
- 4" diameter
- 8' length compressed to approx 30"



V250-TD PLAIN END

- both ends are plain
- 4" diameter
- 8' length compressed to approx 30"

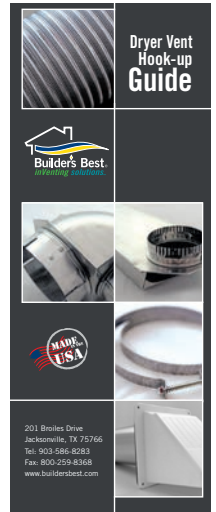

Hook-up Guide Available.

Elbows Enhance Installation

<p>90° TURNS TAKE LESS SPACE</p>	<p>LOOP SYSTEMS PROVIDE GOOD AIRFLOW</p>	<p>2 SECTIONS OF PIPE PROVIDE OVER-THE-TOP CONNECTIVITY</p>
---	---	--

Builder's Best is proud to label the first complete line of ALL METAL UL® 2158 dryer venting which complies with clothes dryer manufacturer recommendations.



SAF-T-DUCT® UL® DRYER VENT KITS

UL® METAL DRYER VENT KITS



SINGLE ELBOW KIT UL®

- One piece 8' UL® flexible pipe
- One Close Elbow®
- One crimped (male) fitting
- Two metal clamps



UL® Single Elbow Kit

Diameter	Length	Part #	Qty	Package	UPC
Single Elbow Kit UL®					
4"	8'	111718	4	Ind. Box	
Close Loop™ Kit UL®					
4"	6'	111693	4	Ind. Box	
	6'	111926	4	Display Box	•
Over-The-Top® Kit UL®					
4"	8'	111920	4	Ind. Box	
Installer's Kit® UL®					
4"	8'	111922	4	Ind. Box	

CLOSE LOOP™ KIT UL®

- One piece 6' UL® flexible pipe
- Two Close Elbows®
- Two metal clamps



UL® 6' Close Loop Kit

OVER-THE-TOP® KIT UL®

- Two 4' UL® flexible pipe sections
- Two Close Elbows® (attached to pipe)
- Two metal clamps for wall and dryer connections
- One wall plate for flush clearance

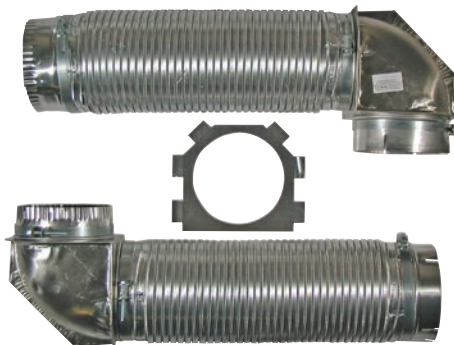

UL® Over-The-Top®

INSTALLER'S KIT® UL®

- One 4' UL® flexible pipe attached to a Close Elbow®
- One 4' UL® flexible pipe attached to a Wall Offset Elbow®
- One extension collar (used for recessed wall pipes)
- Two clamps for wall and dryer connection

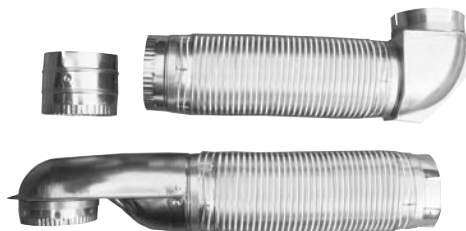

UL® Installer's Kit®

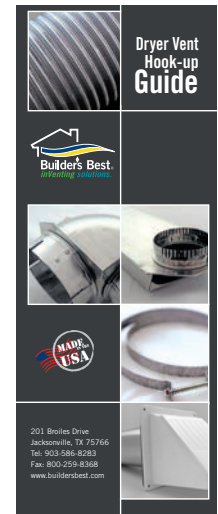

Hook-up Guide Available.

Parts in Red indicate Display Packaging.



Builder's Best is proud to label the first complete line of ALL METAL UL® 2158 dryer venting which complies with clothes dryer manufacturer recommendations.

SAF-T-DUCT® DRYER VENT KITS

OVER-THE-TOP® SNAP-LOCK™ DRYER VENT KIT



- Installs in 4½", when wall pipe is trimmed flush and wall plate is used. Swivel collars on elbows allow dryer to be pulled away from wall for cleaning without disconnecting.
- Kit contains:
 - 2 - 4 ft pipe sections
 - 2 - Close Elbows® (attached)
 - 2 - clamps for wall and dryer connections
 - 1 - wall plate for flush clearance
- Total kit length: 8 feet
- Pipe snap-locks together, as final step

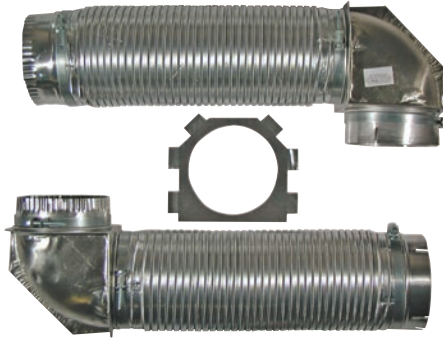

Part #	Qty	Package	UPC
110171	4	Display Box	•
110127	6	bulk	
UL® version			
111920	4	Ind. Box	

INSTALLER'S KIT® WITH SNAP-LOCK™ DRYER VENT KIT



Wall offset elbow allows the wall pipe to protrude up to 2½" without trimming. Box is kraft with UPC barcode and instructions printed in black on the outside.

- Kit contains:
 - 1 - 4 ft pipe section attached to a Close Elbow®
 - 1 - 4 ft pipe section attached to a wall elbow®
 - 1 - extension collar (for recessed wall pipe)
 - 2 - clamps for wall and dryer connection
- Total kit length: 8 feet

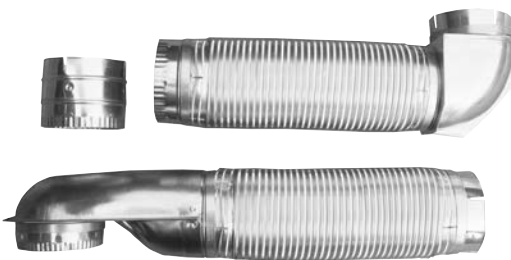

Part #	Qty	Package	UPC
110095	4	Ind. Box	•
110096	6	bulk	
UL® version			
111922	4	Ind. Box	

ALL METAL KITS WITH ELBOWS



- One piece Flexible pipe
- Two Close Elbows®
- Four metal clamps

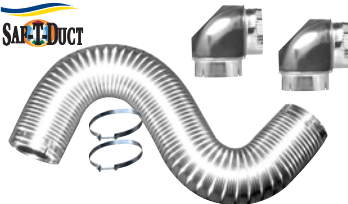

Pipe	Part #	Qty	Package	UPC
4" x 6' V830 Builder's Best® Loop Kit*	110043	4	Ind. Box	•
*This kit only requires two clamps thanks to the Snap-Lock Pipe.				
4" x 6' V430 Readi-Pipe™ Loop Kit	110049	4	Ind. Box	•
4" x 8' V430 Readi-Pipe™ Loop Kit	110050	4	Ind. Box	•

ALL METAL KITS WITH HOODS

- V230 or V220 plain end flexible pipe
- 5' and 8' lengths
- Two metal clamps
- Hoods have 10" tails and may require assembly

Pipe	Hood Style	Part #	Qty	Package	UPC
4" x 5' V230	Wide Mouth Aluminum	112101	4	Ind. Box	•
4" x 8' V230	Wide Mouth Aluminum	110536	4	bulk	
4" x 8' V220	White Wide Mouth Plastic	110625	12	Ind. Box	•
4" x 8' V220	Brown Wide Mouth Plastic	110626	12	Ind. Box	•
4" x 8' V220	Brown Louvered Plastic	112100	6	Ind. Box	•
4" x 8' V220	White Louvered Plastic	111405	6	Display Box	•
4" x 5' V220	Wide Mouth Aluminum	110537	4	Display Box	•

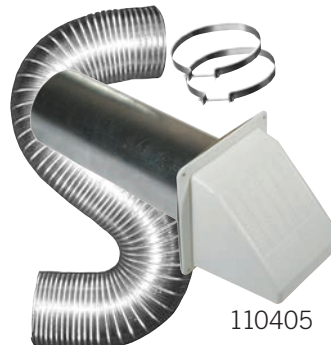

110405



110537

Parts in Red indicate Display Packaging.

SAF-T-DUCT® PERISCOPES

ZERO PERISCOPE™

- Available in 0-5 and 0-18 lengths
- Use where outlets overlap or are very close
- Baffles help direct airflow in 3-5" situations
- Sections are not reversible

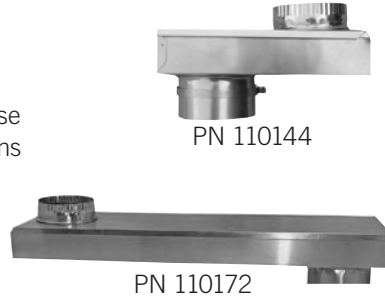

Length	Part #	Qty	Package	UPC
0-5" with baffle	110175	9	Display Card	•
no baffle	110144	9	bulk	
no baffle	110149	8	Ind. Box	•
0-18" with baffle	110172	4	Display Box	•
with baffle	110128	4	Display Bag	•
with baffle	010158	8	Display Bag	•
with baffle	110146	8	bulk	
with baffle	110148	4	Ind. Box	•

18-29" PERISCOPE

- Reaches side of most dryers
- Two piece assembly



Length	Part #	Qty	Package	UPC
18-29"	110173	4	Display Box	•
	110133	4	Display Bag	•
	010153	9	Display Bag	•
	110114	9	bulk	
	110116	4	Ind. Box	•

29-50" PERISCOPE

- Reaches top of most dryers
- Four piece assembly



Length	Part #	Qty	Package	UPC
29-50"	110174	4	Display Box	•
	110117	4	Ind. Box	•

Parts in Red indicate Display Packaging.

EXTENSION PIECES

- 2" x 6" rigid metal with no fittings
- Slide into and over 18-29, 29-50 and 29-74" sections to lengthen.
- Use aluminum tape to secure the sections

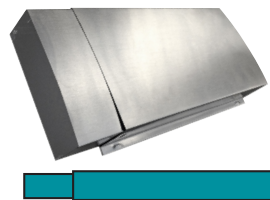

Length	Part #	Qty	Package
23" extension	110141	8	bulk
43" extension	110142	8	bulk

Slide • Rotate • Adjust • Maintain Airflow

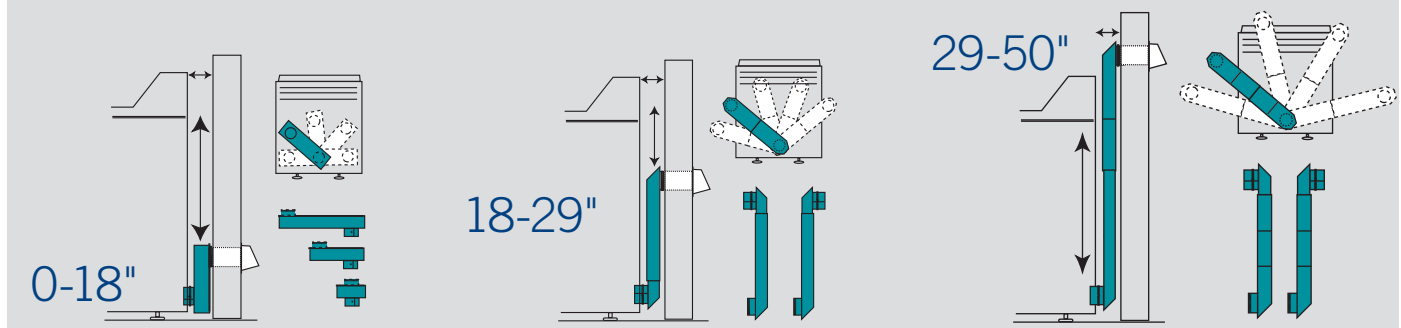

SAF-T-DUCT® Periscopes are 2" x 6" rigid aluminum with 4" draw-band collars and Snap-Lock™ crimped fittings. These periscopes reduce the space needed behind the dryer from 6" with pipe along to 2" WITHOUT reducing airflow. We cover the widest range of lengths in the industry.

SAF-T-DUCT® IN-WALL PERISCOPES

GALVANIZED ROUGH-IN SYSTEM

- 29" to 74" length (6' version)
- 30 Gauge Galvanized Steel
- In-wall (prior to dry-wall)
- Standard 4" diameter fittings
- Mounting strap included
- 6' or 8' length (for 8' or 10' ceilings)



Description	Part #	Qty	Package
6' Galvanized Periscope	110868	3	Ind. Box
8' Galvanized Periscope	110869	3	Ind. Box

ALUMINUM ROUGH-IN SYSTEM

- 29" to 74" length
- 26 gauge aluminum
- Four telescoping sections
- One male snap-lock fitting
- One female snap-lock collar
- Mounting strap included

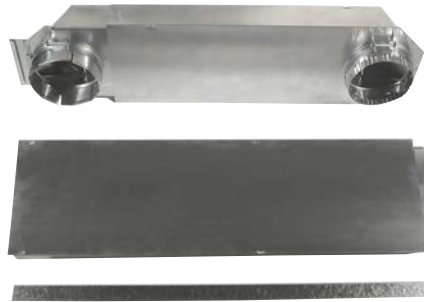

Description	Part #	Qty	Package	UPC
6' Aluminum Periscope	110094	3	Display Box	•
	110140	3	Ind. Box	•

BUILDER'S BEST® DRYER EAVE VENT

- 4" collar
 - Back draft flapper
 - No screen per IBC building codes
 - Installs flush with eave
- Good for clothes dryer venting.



Description	Part #	Qty	Package	UPC
4" female snap-lock collar	110166	8	Display Card	•
	110139	8	bulk	
4" male crimped collar	110200	8	bulk	

Parts in Red indicate Display Packaging.

When it is not possible to vent using a through-wall vent hood, an in-wall periscope and eave vent work well.

Install the periscope well off the floor to allow for dryer duct. Cut a hole in the top plate to run the periscope to the access. Continue the run with flexible or rigid pipe according to code.

The Builder's Best® aluminum dryer eave vent maintains critical airflow but is hidden from view within the eave. The lightweight back-draft flapper is designed to lay open gently while in use without making a sound.

Lint from the dryer is easily dispersed into the air.

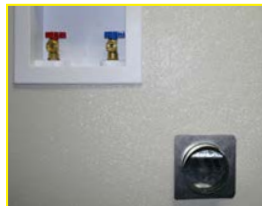

This 6' galvanized periscope is installed with fittings facing the same direction.

The bottom outlet is installed 19" off the floor to allow for easier dryer hookups.



SAF-T-DUCT® DRYER OUTLET BOX

DRYER OUTLET BOX

- One Self trimming unit:
18" wide by 24" high
- Fits all 16" centers 2x4's and 2x6's;
- Six prescored, true 4" diameter knockouts in most common positions
- Six starburst knockouts for gas connections and venting
- Plastic meets UL® standard 94HB tests for flammability



Description	Part #	Qty	Package	UPC
Single box	110697	10	bulk	
	110698	3	Ind. Box	
	110696	3	Display Box	•
Box with round to oval adapter/fitting:				
	111563	3	Display Box	•

Parts in Red indicate Display Packaging.

DRYER OUTLET BOX KIT

Kit Includes:

- One Dryer Outlet Box
- One Periscope
- Two rectangle to round transitions



Description	Part #	Qty	Package
Kit for 8' wall	111000	5	Ind. Box
Kit for 10' wall	111001	5	Ind. Box

TRANSITIONS



110518



111396



111850

Description	Part #	Qty	Package
Rectangle to round	110518	12	bulk
Round to oval	111396	16	bulk
Plastic squeeze elbow	111850	9	bulk

Clean finish with the Dryer Outlet Box leaving room for the dryer duct.



Dryer is close without crushing the duct.



Rectangle to round transition going through the header.



This Dryer Outlet Box is installed at the floor.

The 6' In-Wall Periscope has a rectangle to round transition going through the header.

Builder's Best, Inc.
201 Broiles Drive
Jacksonville TX 75766

Email:
sales@venting.biz

Phone:
1-8-U VENT SAFE (1-888-368-7233)
or 903-586-8283

Fax:
1-800-259-VENT (1-800-259-8368)
or 903-586-9370

www.BuildersBest.com

The All Metal Solution to Dryer Venting™, inVenting solutions™ E-Z-Fasten™ Read-i-Pipe™ Econo-Pipe™ Metalflex™ Pro-Vent™ and ZipTorq™ are trademarks of Builder's Best, Inc. Over-The-Top® Builder's Best® SAF-T-DUCT® Nemco® and the Builder's Best Logo are registered trademarks of Builder's Best, Inc.

Builder's Best, Inc. parts are covered by U.S. Patents: 5,121,948; 5,133,579; 5,145,217; 5,158,328; 5,498,204; 5,653,631; 5,819,435; 5,943,743; 6,035,495; 6,370,794; 6,390,510; D.335,174; D.342,130; D.342,782; Canadian patents 2,062,123; 2,063,098; 2,201,956; 2,279,599; 2,299,989; 2,317,863; Builder's Best, Inc.; © and/or patents pending.