

Aftermarket Motors & Accessories

ENGINEERED
QUALITY
UNMATCHED
VERSATILITY

Totaline® has a full line-up of affordable replacement aftermarket motors and accessories you need to get the job done the right way.

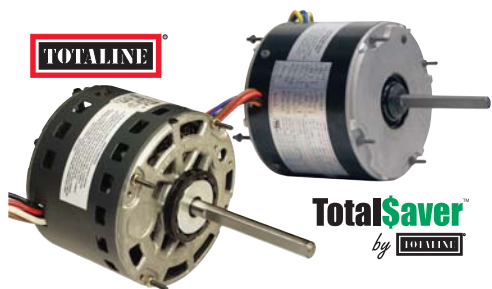

TABLE OF CONTENTS



The Perfect Balance of Versatility and Affordability

With Totaline® and TotalSaver® brand motors, you're ready for any aftermarket replacement.



Reduce your stress and restore your balance. Your local Totaline Sales Center has a full line-up of affordable replacement aftermarket motors with names you can trust, like our long-established Totaline brand, and our fighting brand, TotalSaver.

To find the locations of your local Totaline Sales Centers, please visit www.totaline.com.

TABLE OF CONTENTS

MOTORS

General Information

Definitions	Page 4
Selection	Page 5
Installation Tips	Page 5
Tips to Identify A Motor Without A Nameplate	Page 5-6

Condenser Fan Motors

Totaline® - Totally Enclosed, All Position Mounting	Page 7
Totaline® - Three Phase	Page 7
Totaline® - Single Phase	Page 8
Totaline® - Multi Horse Power	Page 8
TotalSaver® - Totally Enclosed, All Position Mounting	Page 9
TotalSaver® - Multi Horse Power	Page 9
Totaline® - 460V High Temperature	Page 10
NIDEC® - 70°C High Temperature	Page 10

Direct Drive Blower Motors

Totaline® - 115V, 208-230V	Page 11
Totaline® - Multi Horse Power	Page 11
TotalSaver® - 115V, 208-230V	Page 12
TotalSaver® - Multi Horse Power	Page 12

Generic Replacement Motors

Evergreen® EM- X13 ECM Replacements	Page 13
Evergreen® IM - PSC Replacements	Page 13

Belted Blower Motors

Totaline® - Split Phase	Page 14
Totaline® - Capacitor Start	Page 14

Oil Burner Motors

Totaline® 60 Hertz	Page 15
--------------------	---------

MOTOR ACCESSORIES

Universal Replacement Propellers

General Information	Page 16
Typical Applications	Page 16
Blade Shape	Page 16
Props for the Replacement Business	Page 16
Why Install a new Propeller?	Page 16
Propeller Vibration	Page 16
Pitch Selection	Page 16
Identifying Propeller Rotation	Page 16
Replacing a Propeller	Page 17
Horsepower Conversion Chart	Page 17
Safety Tips	Page 17

Universal Replacement Propellers

Hub Type Propellers (Aluminum Fixed Hub)	Page 18
Hubless Type (Interchangeable Hubs)	Page 18
Fixed Hub Propellers (2-Blade with 1/2" Bore)	Page 19
Heavy Duty Condenser Type (3-Blade)	Page 20-21
Heavy Duty Condenser Type (4-Blade)	Page 22-24

Propeller Accessories

Interchangeable Hubs	Page 24
----------------------	---------

Blower Wheels

Double Inlet Blower Wheels	Page 25-27
Single Inlet Blower Wheels	Page 28-30
Galvanized	Page 30

Totaline® Fan Belts

Fractional HP V-Belts	Page 31
Multiple V-Belts	Page 32-33
Narrow V-Belts, Cogged	Page 34

Totaline® Capacitors

General Information	Page 35
Oval Motor Run Capacitors	Page 36-37
Round Motor Run Capacitors	Page 38

Parts & Accessories

Rainshields	Page 39
Rubber Fan Hub Cap	Page 40
Hub Pullers	Page 40
Replacement Parts for Hub Pullers	Page 40
Pitch Gauge	Page 40
TECINspect Diagnostic Tool	Page 40
Totaline Bracket Kits	Page 41
Direct Drive Motor Mounting Brackets	Page 41
Bearing Brackets for Belt Drive Blowers	Page 42
Knock Down Bracket Kit	Page 42
Sleeve Bearing Bracket Kit	Page 42
Bearings	Page 43-44
Thrust Kits	Page 45
Vibro Pads	Page 45
Mounting Hardware	Page 45
Grommets	Page 45
Shafts	Page 46
Blower Shafts	Page 46
Shaft Bushings	Page 46
Adjustable Motor Pulleys	Page 46

CROSS REFERENCE

Cobra Blade Cross Reference	Page 47
Motor Cross Reference	Page 48-51



MOTOR INFORMATION

DEFINITIONS

SHADED POLE MOTORS

- Single Phase

For use in light-duty appliances because of low efficiency, power factor and starting torque. These motors are only suitable for direct drive fan and blower applications.

PERMANENT-SPLIT CAPACITOR MOTORS

- Single Phase

This type motor is similar to the shaded pole type but has higher efficiency and power factor. Starting torques are relatively low which limits application only for direct drive fan and blower applications.

SPLIT-PHASE MOTORS

- Single Phase

Split-phase motors have moderate starting torque with low starting current. They are used where starting load is moderate and where there is frequent starting with relatively long running periods. Reversible.

CAPACITOR-START MOTORS

- Single Phase

This type motor produces greater locked-rotor and accelerating torque per amp than the split phase type. With a higher starting torque than the split-phase type it can be used for driving compressors, pumps, air conditioning equipment and many other hard-to-start applications.

POLYPHASE-SQUIRREL CAGE INDUCTION MOTORS

- Three Phase

Polyphase motors have a high starting torque combined with high efficiency and power factor which makes them suitable for use on larger compressors and commercial air conditioning units. Do not require capacitors or starting relays. Reversible.

DEFINITIONS FOR LISTING ON FOLLOWING MOTORS PAGES

HP: Horsepower - Power rating of the motor

FLA: Full Load Amps - Amperage drawn by a motor when operating at rated load and voltage.

NOTE: RCD may use several motor suppliers for any given part number. Therefore FLA listed represents maximum rating that could be encountered under a given part number.

RPM: Synchronous speed or full load speed

HZ: Frequency or Hertz

V: Voltage AC

: Rotation Reversible

°C: Ambient Rating

CAP: Capacitor Rating (i.e. 5.0 μ f / 370 volts)

A: Amp rating at Full Load (i.e. 1.8A)

PSC: Permanent Split Capacitor motors single phase. This type of motor has high efficiency and power factor with starting torques relatively low, which limits the application only for direct drive fan and blower applications.

TE: Totally Enclosed Motor

OP: Open Enclosure

Speed: 1: Single Speed Motor

Mounting: Base, Stud, Strap

ROT. Rotation - Motors rotate in either a clockwise (CW) or counterclockwise (CCW) direction. Rotation listed is per NEMA, as viewed from the end of the motor opposite the shaft. In the case of double shaft motors, the rotation is viewed from the lead end of motor.

SF: Service Factor - A measure of the overload capacity designed into a motor. A 1.15 SF means the motor can deliver 15% more than a rated horsepower without injurious overheating. A 1.0 SF motor should not be overloaded beyond its rated horsepower.

BRGS: Bearings - SLV/BALL

FRAME: An (R), (S) or (T) may appear in this column adjacent to the NEMA frame designation and is defined as follows:

(R) - Resilient mounting rings included

(S) - Motor is mounted on rigid base

(T) - Motor is equipped with extended thru-bolts required for thru-bolt mounting

DIA: Diameter of motor in inches

SHAFT: Length/Diameter (i.e. 6.5" / 1/2").

First shaft length listed is at lead end of dual shaft motors.

NOTE: RCD may use several motor suppliers for any given part number. Therefore, shaft length(s) listed represent maximum length(s) available under a given part number.

Protector: Internal Thermally Protected

MOTOR DIMENSIONS:

- A. Overall length of motor including shaft(s)
- B. Diameter of mounting bold circle on motors supplied with mounting ears
- C. Shaft height - center of shaft to base on motors supplied with mounting base
- D. Diameter of mounting hole on motors supplied with mounting lugs

MOTOR SELECTION

When selecting either an indoor blower motor or outdoor condenser motor, always start with the following:

- **HP:** always try to use the same horsepower that was in the original equipment application, specifically within that frame size
- **RPM's:** selected should be in the $\pm 10\%$ range
- **AMPS:** never exceed the full load amps by more than $\pm 10\%$
- **Voltage:** should always be the same as the equipment
- **Capacitor:** may require a change to reflect the microfarads (μF) required by the motor (i.e. $5\mu\text{F}$ to $7.5\mu\text{F}$)

INSTALLATION TIPS



Before installing motors always measure the approximate propeller fan, or blower wheel location to make sure your final installation ends up in the same area in condenser orifices or blower housings to maintain the same air flow.

Make sure the hubs of the old fans or blower wheels are not stripped and the set screws are tight to the flat of the shaft.

Outdoor propeller fan blades flex during operation. Make sure you have enough clearance so that the fan blades do not contact the mounting screws of the motors on the shaft end. (If necessary, cut the installation screws back to avoid a fan hit.)

Motor must be securely and adequately grounded by wiring per NEC and local codes.



MOTOR INFORMATION

TIPS TO IDENTIFY A MOTOR WITHOUT A NAMEPLATE

Motor Diameter: Measure diameter to confirm NEMA (National Electrical Manufacturers Association) frame size.

Frame size: 4.9"= 42, 5.6"= 48, 6.5"= 56

Motor Type: Shaded Pole (SP), Permanent Split Capacitor (PSC), Split Phase, Capacitor Start/Capacitor Run, Three Phase, and DC.

Speed: RPM = 120 x Hz / # Poles

@ 60Hz # Poles	Full Load Speed			
	Syn	SP	PSC	General Purpose
2	3600	3000	-	3450
4	1800	1500	1625	1725
6	1200	1050	1075	1140
8	900	-	825	850

Count # of Poles

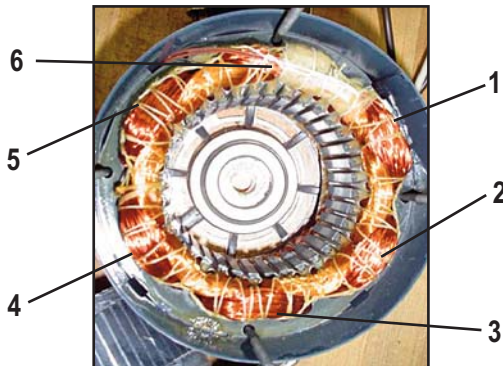

Horsepower & Stack Lengths:

4 & 6 Pole Open Motors

HP	Approx. Stack Length
1/4	1.25"
1/3	1.50"
1/2	2.25"
3/4	2.50"

8 Pole Open Motors

HP	Approx. Stack Length
1/8	1.13"
1/6	1.25"
1/4	1.62"
1/3	2.25"

4 & 6 Pole Closed Motors

HP	Approx. Stack Length
1/4	1.25"
1/3	1.75"
1/2	2.50"
3/4	3.00"

8 Pole Closed Motors

HP	Approx. Stack Length
1/8	1.25"
1/6	1.38"
1/4	1.75"
1/3	2.50"



Measure Stack Height For HP

Number Of Speeds:

- Number Speeds = number of power leads minus 1.
- For SP - **Do not count** the ground (green) lead.
- For PSC - **Do not count** the ground (green) lead or the capacitor (brown) lead.

Mechanical Features:

- Mounting Definition - Base, Belly band, Lugs, Studs, Face mount, etc.
- Enclosure - ODP (Open Drip Proof), TE (Totally Enclosed), etc.
- Shaft - Number, Length, Diameter, Flat-Keyway, etc.
- Unique Features - Leads, Conduit Box, Bearings, Brake, Rotation Arrow, Capacitor Cover, Slings, etc.

Rotation:

- Most standard motors (except Single Phase and Threaded Shaft) are reversible from standstill by electrical re-connection.
- Three phase motors reversed by interchanging any two of the three power leads.

Note: Rotation of an unknown motor is often found by noting attached fan, blower or other device. Dirt accumulates on the side towards which the motor rotates.

Voltage: Common Voltage

	115	230	Dual	277	460	575
SP	X	X	-	X	-	-
PSC	X	X	-	X	X	-
Split Ph	X	X	-	-	-	-
Cap Start	X	X	115/230	-	-	-
3 Phase	-	X	230/460	-	X	X

Note: Voltage may be difficult to determine. **Ask the customer!**

Typical Color Schemes (Not a standard):

- White - Common lead (115 volt)
- Yellow or Purple - Common lead (230 volt)
- Brown - Capacitor leads (1 or 2)(PSC Only)
- Black - High
- Blue - Medium
- Red - Low
- When replacing PSC a good practice is to replace the capacitor, too.
- Replace based on horsepower not AMP rating.
- Do not replace manual overload with automatic overload motor.
- Motors with similar stator dimensions will have output (other features being equal). I.e. It takes a similar amount of iron and copper (D2L) for torque.

Some rules of thumb:

Generally if this is... (the original)	This can be used as a replacement
Shaded Pole	Permanent Split Capacitor Ball Bearing
Sleeve Bearings	Sleeve Bearing Totally
Open or DP	Enclosed
1 Speed	1, 2 or 3 Speed
2 Speed	2 or 3 Speed
370 Volt Capacitor	370 or 460 Volt Capacitor

CONDENSER FAN MOTORS

TOTALINE® CONDENSER FAN MOTORS

TOTALLY ENCLOSED - ALL POSITION MOUNTING (ALL ANGLE 60 HERTZ)

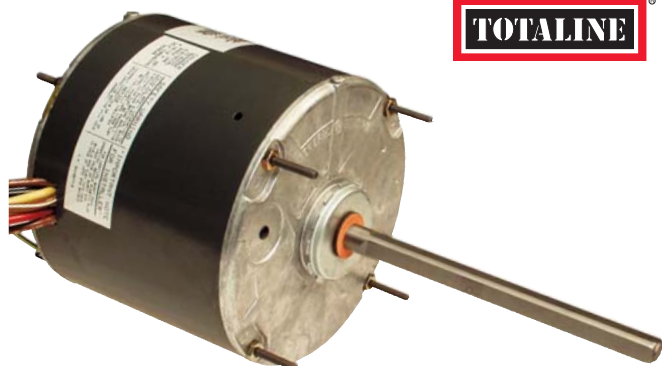

- Slinger protects bearing when motor is mounted in shaft up or horizontal position (remove slinger when motor is mounted in shaft down position)
- Rated continuous air over
- Automatic reset thermal protection
- Permanent split capacitor
- Class B Insulation
- Reversible by electrical reconnection
- 26" leads
- 6" shaft with 2 full flats, 90° apart
- NEMA 48 Frame
- Single Phase, 60 Hertz

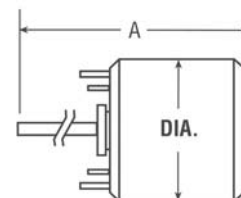
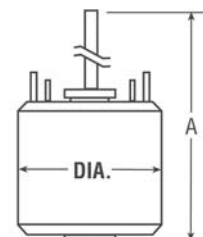

MOTOR Part No.	HP	VOLTAGE	FLA	RPM/ SPEED(S)	BRGS.	DIMENSIONS (IN.) A	AMBIENT	CAPACITOR MFD VOLTS	CAPACITOR Part No.
P257-8727	1/6	208-230	1.0	1075/1	SLV		60° C	5/370	P291-0503
P257-8728	1/4	208-230	1.8	1075/1	SLV	10.7"	60° C	5/370	P291-0503
P257-8729	1/3	208-230	2.4	1075/1	SLV	11"	60° C	7.5/370	P291-0753
P257-8730	1/2	208-230	3.5	1075/1	SLV	12.2"	60° C	10/370	P291-1003
P257-8731	3/4	208-230	5.5	1075/1	SLV		60° C	10/370	P291-1003

MOTOR Part No.	HP	VOLTAGE	FLA	RPM/ SPEED(S)	BRGS.	DIMENSIONS (IN.) A	AMBIENT	CAPACITOR MFD VOLTS	CAPACITOR Part No.
P257-8228	1/4	208-230	1.6	1075/2	SLV	11"	60° C	5/370	P291-0503
P257-8229	1/3	208-230	2.4	1075/2	SLV	11.5"	60° C	7.5/370	P291-0753
P257-8230	1/2	208-230	3.8	1075/2	SLV	12.5"	60° C	10/370	P291-1003

TOTALINE® CONDENSER FAN MOTORS

- Vertical shaft up mount
- Positioning screws in motor shell
- Water slinger for bearing protection
- Class B Insulation
- Reversible rotation
- NEMA 56 Frame
- 5/8" x 6" shaft with 5" flat and 5" long keyway - key not provided

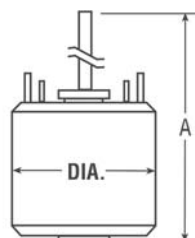

THREE PHASE

MOTOR Part No.	HP	VOLTAGE	FLA	RPM/ SPEED(S)	BRGS.	DIMENSIONS (IN.)	AMBIENT
P257-E378	3/4	208-230/460	3.6/1.8	1140	BALL	16.8"	60° C
P257-E379	1.0	208-230/460	4.8/2.4	1140	BALL	16.8"	60° C
P257-E380	1-1/2	208-230/460	6.4/3.2	1140	BALL	16.8"	60° C



CONDENSER FAN MOTORS

TOTALINE® CONDENSER FAN MOTORS (60 HERTZ)

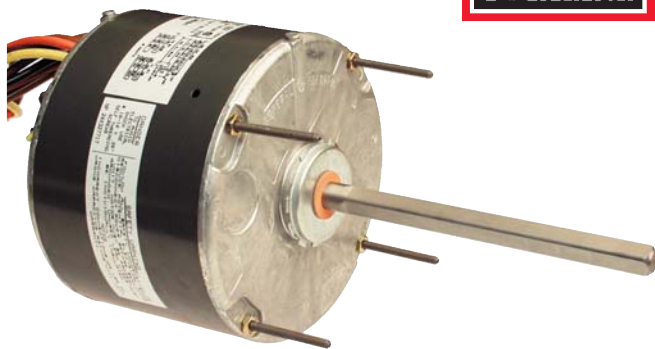

- Suitable for vertical shaft up or horizontal mounting
- Permanent split capacitor
- Automatic reset thermal protection
- Totally enclosed shaft end bracket, open opposite end
- Slinger for bearing protection
- 26" leads
- NEMA 48 Frame
- Reversible by electrical reconnection
- Class B Insulation

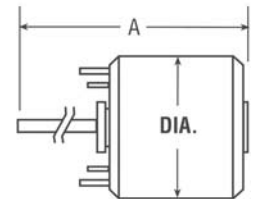
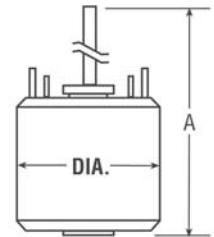

SINGLE PHASE

MOTOR Part No.	HP	VOLTAGE	FLA	RPM/SPEED(S)	BRGS.	SHAFT DIA. & LENGTH (IN.)	DIMENSIONS (IN.)		AMBIENT	CAPACITOR MFD VOLTS	CAPACITOR Part No.
							DIA.	A			
P257-8328*	1/4	208-230	1.8	1075/1	SLV	1/2" x 6"	5.6"	11.1"	60° C	5/370	P291-0503
P257-8028	1/4	208-230	1.5	1075/2	SLV	1/2" x 6"	5.6"	11.1"	60° C	5/370	P291-0503
P257-8046	1/4	208-230	1.5	1075/2	BALL	1/2" x 6"	5.6"	11.1"	60° C	5/370	P291-0503
P257-8329*	1/3	208-230	2.4	1075/1	SLV	1/2" x 6"	5.6"	11.4"	60° C	7.5/370	P291-0753
P257-8029	1/3	208-230	2.1	1075/2	SLV	1/2" x 6"	5.6"	11.9"	60° C	7.5/370	P291-0753
P257-8031	1/3	208-230	2.1	1075/2	BALL	1/2" x 6"	5.6"	11.9"	60° C	7.5/370	P291-0753
P257-8026	1/3	208-230	2.2	825/1	BALL	1/2" x 6"	5.6"	12.1"	60° C	10/370	P291-1003
P257-8330*	1/2	208-230	3.6	1075/1	SLV	1/2" x 6"	5.6"	12.1"	60° C	10/370	P291-1003
P257-8030	1/2	208-230	3.5	1075/2	SLV	1/2" x 6"	5.6"	12.4"	60° C	10/370	P291-1003
P257-8032	1/2	208-230	3.5	1075/2	BALL	1/2" x 6"	5.6"	12.4"	60° C	10/370	P291-1003
P257-8048	3/4	208-230	4.1	1075/2	BALL	1/2" x 6"	5.6"	12.4"	60° C	15/370	P291-1503

* Denotes high efficiency.

TOTALINE® CONDENSER FAN MOTORS

- Reversible rotation
- NEMA 48 Frame
- 36" leads
- All position mount
- Mounts with thru-bolts, shell holes or belly band



MULTI-HORSEPOWER

MOTOR Part No.	HP	VOLTAGE	FLA	RPM/SPEED(S)	BRGS.	DIMENSIONS (IN.)	AMBIENT
P257-E5462	1/6-1/3	208/230	2.6	1075/2	SLV	3.75" X 1/2"	60° C
P257-E5465	1/5-1/2	208/230	3.25	1075/2	BALL	5" X 1/2"	60° C
P257-E5464	1/6-1/3	208/230	2.55	825/2	BALL	5" X 1/2"	60° C

CONDENSER FAN MOTORS

TotalSaver® CONDENSER FAN MOTORS TOTALLY ENCLOSED - ALL POSITION MOUNTING



TotalSaver
by **TOTALINE**

- Suitable for vertical shaft up or horizontal mounting
- Permanent split capacitor
- Automatic reset thermal protection
- Totally enclosed shaft end bracket, open opposite end
- 26" leads
- NEMA 48 Frame
- Reversible by electrical reconnection
- Class B Insulation

MOTOR Part No.	HP	VOLTAGE	FLA	RPM	BRGS.	SHAFT DIA. & LENGTH (IN.)	TEMP RISE	HZ	CAPACITOR MFD VOLTS	CAPACITOR Part No.
T257-3727	1/6	208-230	1.0	1075	SLV	1/2" x 6.5"	60° C	60	5/370	P291-0503
T257-3728	1/4	208-230	1.8	1075	SLV	1/2" x 6.5"	60° C	60	5/370	P291-0503
T257-3729	1/3	208-230	3.0	1075	SLV	1/2" x 6.5"	60° C	60	7.5/370	P291-0753
T257-3730	1/2	208-230	3.6	1075	SLV	1/2" x 6.5"	60° C	60	10/370	P291-1003
T257-3731	3/4	208-230	5.5	1075	SLV	1/2" x 6.5"	60° C	60	10/370	P291-1003

TotalSaver® CONDENSER FAN MOTORS



TotalSaver
by **TOTALINE**

- Three models cover 208-230 Volt
- Applications from 1/6 to 1/2 HP
- Thru bolt or band mounting
- Class B Insulation
- Thermal overload protected

MULTI-HORSEPOWER

MOTOR Part No.	HP	VOLTAGE	FLA	RPM	BRGS.	SHAFT DIA. & LENGTH (IN.)	TEMP RISE	HZ	CAPACITOR MFD VOLTS	CAPACITOR Part No.
T257-3465	1/6-1/3	208-230	2.6	1075	SLV	1/2" x 3.75"	60° C	60	5/7.5/370	P291-0503*
T257-3468	1/5-1/2	208-230	3.2	1075	BALL	1/2" x 5"	60° C	60	10/12.5/370	P291-1003**
T257-3469	1/6-1/3	208-230	2.5	825	BALL	1/2" x 5"	60° C	60	7.5/10/370	P291-0753***

* At 208V a 7.5 mfd/370V capacitor should be used. Totaline Part Number P291-0753. Amps will be similar.

** At 208V a 12.5 mfd/370V capacitor should be used. Totaline Part Number P291-1253. Amps will be similar.

*** At 208V a 10 mfd/370V capacitor should be used. Totaline Part Number P291-1003. Amps will be similar.



HIGH TEMP. CONDENSER FAN MOTORS

TOTALINE® 460V HIGH TEMPERATURE CONDENSER FAN MOTORS

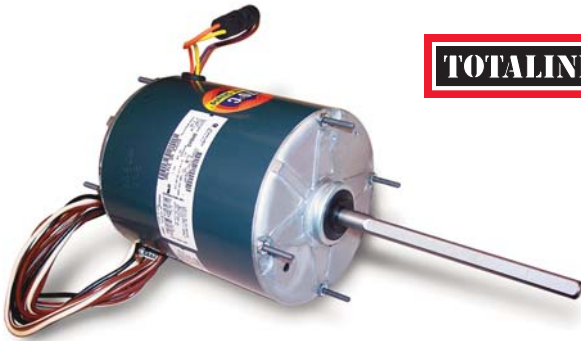

- Totaline Brand Packaging
- 70°C Ambient
- Runs cooler, Lower operating temperatures = improved life & reliability
- Increased lead length to 48"
- All Angle Mounting Position
- Rheem Mounting Holes
- Quick Connects on capacitor leads
- Extended thru bolts on both ends
- Drain holes in both endshields with plugs

MOTOR Part No.	HP	VOLTAGE	RPM/SPEED(S)	FRAME	ROTATION	BEARINGS
P257-3736HS	1/4	460	1075	48	REV	BALL
P257-3737HS	1/3	460	1075	48	REV	BALL
P257-3738HS	1/2	460	1075	48	REV	BALL
P257-3739HS	3/4	460	1075	48	REV	BALL

PSC CONDENSER FAN HIGH TEMPERATURE NIDEC® MOJAVE SERIES



- 158°F (70°C) Ambient Design
- Totally Enclosed Air Over (TEAO)
- Ball Bearings
- Class F Insulation
- Suitable for use with 370V Capacitors
- Extended Studs
- 48" Leads
- 5.6" Diameter
- Hubless Lead End
- Drain Holes Both Ends
- Reversible Rotation
- Automatic Reset Thermal Overload Protector
- Continuous Duty

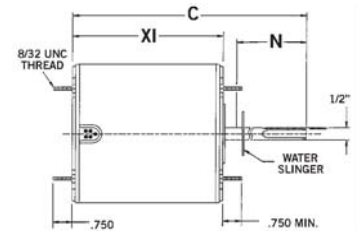

MOTOR Part No.	HP	RPM	VOLTAGE	BEARINGS	CAP MFD	AMPS	SHAFT N	SHELL XI	TOTAL C	SHIP WT LBS
1874H	1/4 - 1/8	825	208-230	BALL	5.0	2.1	6.0	4.4	10.9	13.0
1860H	1/4	1075	208-230	BALL	5.0	1.7	6.0	4.1	10.6	12.0
1861H	1/3	1075	208-230	BALL	7.5	2.1	6.0	4.6	11.1	14.0
1862H	1/2	1075	208-230	BALL	10.0	3.2	6.0	5.3	11.9	18.0
1868H	3/4	1075	208-230	BALL	10.0	4.7	6.0	5.8	12.4	20.0

DIRECT DRIVE BLOWER MOTORS

TOTALINE® DIRECT DRIVE BLOWER MOTORS

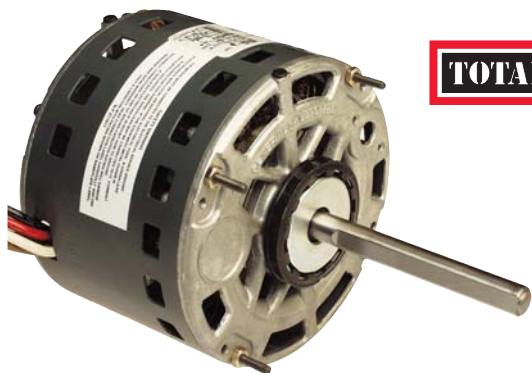

- Electrically reversible
- Continuous air over - 40°C
- All angle sleeve bearings
- NEMA 48 Frame
- Terminal connection for CW/CCW
- Automatic reset overload protection
- 1/2" extended thru bolts shaft end
- 1/2" diameter shaft 4 inches long with full flat
- 2 1/4" resilient rings with 2 1/2" snap rings
- Open construction, non-ventilated motors for exhaust, air circulators, unit heaters, unit coolers, and other air-over applications

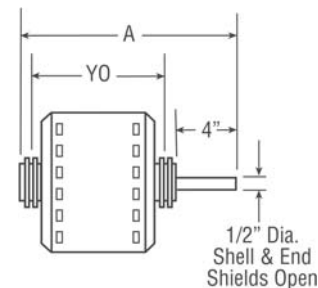

MOTOR Part No.	HP	VOLTAGE	FLA	RPM/SPEED(S)	DIMENSIONS (IN.)		HZ	CAPACITOR MFD VOLTS	CAPACITOR Part No.
					A	YO			
P257-8383	1/4	115	4.2	1075/2	9.1"	4.9"	60	5/370	P291-0503
P257-8384	1/4	208-230	2.0	1075/2	9.1"	4.9"	50/60	5/370	P291-0503
P257-8385	1/3	115	6.2	1075/2	9.4"	5.1"	60	5/370	P291-0503
P257-8386	1/3	208-230	2.9	1075/2	9.4"	5.1"	50/60	5/370	P291-0503
P257-8387	1/2	115	9.0	1075/2	10.4"	6.1"	50/60	5/370	P291-0503
P257-8388	1/2	208-230	4.3	1075/2	10.1"	5.9"	50/60	5/370	P291-0503
P257-8389	3/4	115	10.3	1075/2	10.4"	6.1"	60	15/370	P291-1503
P257-8390	3/4	208-230	4.4	1075/2	10.4"	6.1"	60	10/370	P291-1003

TOTALINE DIRECT DRIVE BLOWER MOTORS

- Open construction, non-ventilated motors for exhaust, air circulators, unit heaters, unit coolers, and other air-over applications
- High or standard efficiency
- 26" leads
- Permanent split capacitor
- Single phase, 60 hertz
- Sleeve bearings
- 2 1/4" to 2 1/2" resilient ring mount
- Automatic reset thermal protection
- Class A Insulation
- NEMA 48 Frame
- Reversible by electrical reconnection of reversing plug

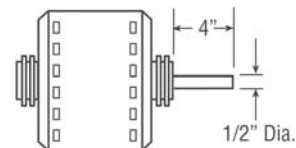

STANDARD EFFICIENCY				HIGH EFFICIENCY				HP	VOLTAGE	RPM/SPEED(S)
MOTOR Part No.	FLA	CAPACITOR MFD VOLTS	CAPACITOR Part No.	MOTOR Part No.	FLA	CAPACITOR MFD VOLTS	CAPACITOR Part No.			
P257-8583	4.2	5/370	P291-0503	P257-8983	3.7	7.5/370	P291-0753	1/4	115	1075/3
P257-8584	2.0	5/370	P291-0503	P257-8984	1.8	5/370	P291-0503	1/4	208-230	1075/3
P257-8585	6.1	5/370	P291-0503	P257-8985	4.9	7.5/370	P291-0753	1/3	115	1075/3
P257-8586	2.7	5/370	P291-0503	P257-8986	2.5	5/370	P291-0503	1/3	208-230	1075/3
P257-8587	9.0	5/370	P291-0503	P257-8987	7.3	10/370	P291-1003	1/2	115	1075/3
P257-8588	4.3	5/370	P291-0503	P257-8988	3.5	7.5/370	P291-0753	1/2	208-230	1075/3
P257-8589	11.2	15/370	P291-1503	P257-8989	10.3	15/370	P291-1503	3/4	115	1075/3
P257-8590	5.0	10/370	P291-1003	P257-8990	5.0	10/370	P291-1003	3/4	208-230	1075/3

MULTI-HORSEPOWER

MOTOR Part No.	HP	VOLTAGE	FLA	RPM/SPEED(S)	BRGS.	DIMENSIONS (IN.)	AMBIENT
P257-E5460	1/6-1/2	115	7.3	1075	SLV	1/2 x 5	60° C
P257-E5461	1/6-1/2	208/230	3.6	1075	SLV	1/2 x 5	60° C
P257-E5470	1/5-3/4	115	8.1	1075	BALL	1/2 x 5	60° C
P257-E5471	1/5-3/4	208/230	3.8	1075	BALL	1/2 x 5	60° C



DIRECT DRIVE BLOWER MOTORS

TotalSaver® DIRECT DRIVE BLOWER MOTORS



TotalSaver
by **TOTALINE**

- Suitable for vertical shaft up or horizontal mounting
- 26" leads
- Permanent split capacitor
- Automatic reset protection
- Class B Insulation
- NEMA 48 Frame

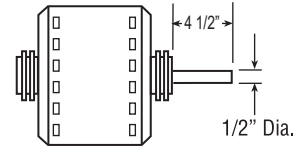

MOTOR Part No.	HP	VOLTAGE	FLA	RPM	BRGS.	SHAFT DIA. & LENGTH (IN.)	TEMP RISE	HZ	CAPACITOR MFD VOLTS	CAPACITOR Part No.
T257-3583	1/4	115	3.7	1075	SLV	1/2" x 4.5"	60° C	60	5/370	P291-0503
T257-3584	1/4	208/230	1.8	1075	SLV	1/2" x 4.5"	60° C	60	5/370	P291-0503
T257-3585	1/3	115	6.1	1075	SLV	1/2" x 4.5"	60° C	60	5/370	P291-0503
T257-3586	1/3	208/230	2.9	1075	SLV	1/2" x 4.5"	60° C	60	5/370	P291-0503
T257-3587	1/2	115	9.0	1075	SLV	1/2" x 4.5"	60° C	60	5/370	P291-0503
T257-3588	1/2	208/230	3.8	1075	SLV	1/2" x 4.5"	60° C	60	5/370	P291-0503
T257-3589	3/4	115	10.0	1075	SLV	1/2" x 4.5"	60° C	60	15/370	P291-0503
T257-3590	3/4	208/230	5.2	1075	SLV	1/2" x 4.5"	60° C	60	10/370	P291-1003

TotalSaver® DIRECT DRIVE BLOWER MOTORS



TotalSaver
by **TOTALINE**

- Four models cover applications from 1/6 through 3/4 HP
- Reversible rotation
- Class B Insulation
- Thermal overload protection
- NEMA 48 Frame

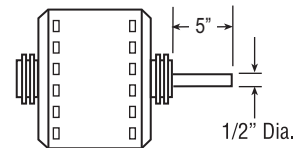

MULTI-HORSEPOWER

MOTOR Part No.	HP	VOLTAGE	FLA	RPM	BRGS.	SHAFT DIA. & LENGTH (IN.)	TEMP RISE	HZ	CAPACITOR MFD VOLTS	CAPACITOR Part No.
T257-3463	1/6-1/2	115	6.5	1075	SLV	1/2" x 5"	60° C	60	5/7.5/10/370	P291-0753*
T257-3464	1/6-1/2	208/230	3.1	1100	SLV	1/2" x 5"	60° C	60	5/7.5/10/370	P291-0753*
T257-3466	1/5-3/4	115	7.2	1075	SLV	1/2" x 5"	60° C	60	10/20/370	P291-1003**
T257-3467	1/5-3/4	208/230	4.6	1100	SLV	1/2" x 5"	60° C	60	10/20/370	P291-1003**

* Use Capacitor Part Number P291-1003 for 1/2 HP usage.

** Use Capacitor Part Number P291-2003 for 3/4 HP usage.

GENERIC REPLACEMENT MOTORS

EVERGREEN® EM X13 AFTERMARKET REPLACEMENT MOTORS BY REGAL/GENTEQ



- No distributor programming required
- Replaces Other Manufacturers OEM X13 ECM Models (does not replace premium ECM constant airflow products such as Eon, 3.0, 2.3 and Multi-Speed Constant Torque Brushless DC Motor)
- Automatically determines motor direction
- 5 discrete speeds using 24VAC (3 using 18VDC)
- NEMA 48 Frame (5.6 inch diameter Belly Band Mount)
- UL and CSA recognized
- Two Year Warranty

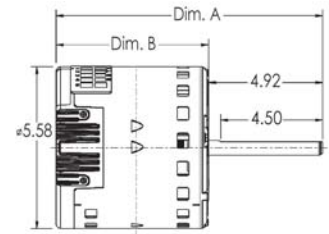

MOTOR Part No.	HP	VOLTAGE	MAX CURRENT	ROTATION	DIM A	DIM B	WEIGHT
6103E	1/3	115	4.8 A	CCW/CW	10.17"	5.25"	8.4
6105E	1/2	115	6.8 A	CCW/CW	10.67"	5.75"	11.3
6107E	3/4	115	8.4 A	CCW/CW	11.42"	6.5"	15.6
6110E	1	115	10.9 A	CCW/CW	12.17"	7.25"	19.3
6203E	1/3	208-230	2.8 A	CCW/CW	10.17"	5.25"	8.4
6205E	1/2	208-230	4.1 A	CCW/CW	10.67"	5.75"	11.3
6207E	3/4	208-230	6.0 A	CCW/CW	11.42"	6.5"	15.6
6210E	1	208-230	7.6 A	CCW/CW	12.17"	7.25"	19.3

EVERGREEN® IM AFTERMARKET PSC REPLACEMENT BY REGAL/GENTEQ



- Replaces other Manufacturers OEM PSC Blower Motors
- Four speed selections for heating and cooling
- Optimized constant fan speed
- Two Year Warranty

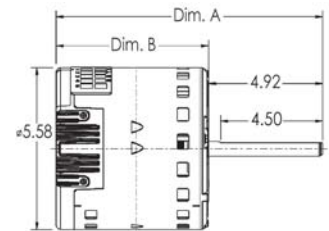

MOTOR Part No.	HP	VOLTAGE	MAX CURRENT	ROTATION	DIM A	DIM B	WEIGHT
6005	1/2	115/230	6.7/4.0 A	CCW/CW	11.26"	6.34"	12.0
6010	1	115/230	11.0/6.7 A	CCW/CW	12.76"	7.84"	20.0
6703	1/3	208-230/277V	2.8 A	CCW/CW	9.17"	5.25"	8.3
6705	1/2	208-230/277V	4.1 A	CCW/CW	9.67"	5.75"	11.3
6707	3/4	208-230/277V	6.0 A	CCW/CW	10.42"	6.5"	15.5



BELTED BLOWER MOTORS

TOTALINE® BELTED BLOWER MOTORS



- Open drip-proof construction
- Reversible rotation by electrical reconnection
- Class A Insulation - 1/6 thru 1/2 HP
- Class B Insulation - 3/4 thru 1 HP
- Automatic reset thermal protection

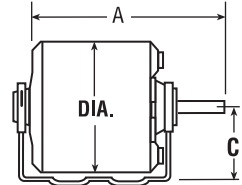

SPLIT PHASE

MOTOR Part No.	NEMA SERVICE FACTORS					BRGS.	RPM/ SPEED(S)	FRAME	SHAFT DIA. & LENGTH (IN.)	TEMP RISE	DIMENSIONS (IN.)			HZ
	HP	VOLTAGE	FLA	SF	DIA.						A	C		
P267-9305‡	1/4	115	4.4	1.35	SLV	1725	48	1/2" x 1.5"	40° C	5.6	9.4	3.0	60	
P267-9308‡	1/3	115	5.4	1.35	SLV	1725	48	1/2" x 1.5"	40° C	5.6	9.9	3.0	60	
P267-9309	1/3	230	2.7	1.35	SLV	1725	48	1/2" x 1.6"	40° C	5.7	9.9	3.0	60	
P267-9758‡	1/2	115	7.9	1.25	BALL	1725	48	1/2" x 1.5"	40° C	5.6	9.9	3.0	60	
P267-9392	1/2	115	8.0	1.25	SLV	1725	56	5/8" x 2"*	40° C	6.5	9.8	3.5	60	
P267-9310	1/2	115/230	3.9	1.25	SLV	1725	48	1/2" x 1.6"	40° C	5.7	10.4	3.0	60	
P267-D136	1/2	115/230	8.0/4.0	1.25	SLV	1725	56	5/8" x 2"*	40° C	6.5	9.8	3.5	60	
P267-D231	3/4	115	11.8	1.25	SLV	1725	56	5/8" x 2"*	40° C	6.5	9.8	3.5	60	
P267-D232	3/4	230	5.6	1.25	SLV	1725	56	5/8" x 2"*	40° C	6.5	9.8	3.5	60	

* Keyed motor shaft. ‡ Mounting holes are combination 48 and 56, shaft height is 3.0", includes 5/8" dia. shaft adapter.

TOTALINE® BELTED BLOWER MOTORS

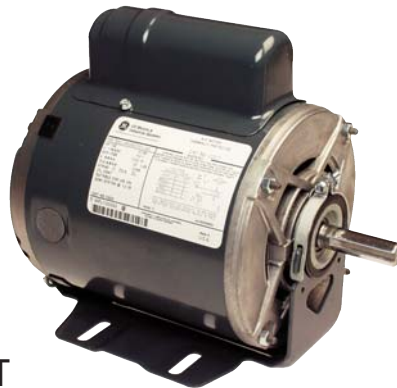

- Resilient mount
- Open drip-proof construction
- Class A Insulation - 1/2 HP
- Class B Insulation - 3/4 and 1 HP
- Reversible rotation by electrical reconnection
- Automatic reset thermal protection
- NEMA 56 Frame

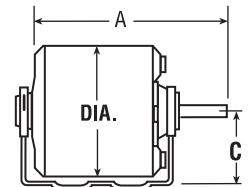

CAPACITOR START

MOTOR Part No.	NEMA SERVICE FACTORS					BRGS.	RPM/ SPEED(S)	SHAFT DIA. & LENGTH (IN.)	TEMP RISE	DIMENSIONS (IN.)			HZ
	HP	VOLTAGE	FLA	SF	DIA.					A	C		
P268-E223	1/2	115/230	8.6/4.3	1.25	BALL	1725	5/8" x 2"	40° C	5.6	9.3	3.5	60	
P268-E231	3/4	115/230	11.4/5.7	1.25	BALL	1725	5/8" x 2"	40° C	5.6	10.8	3.5	60	
P268-E236	1	115/230	13.0/6.5	1.15	BALL	1725	5/8" x 2"	40° C	6.2	11.8	3.5	60	

OIL BURNER MOTORS

TOTALINE® OIL BURNER MOTORS (60 HERTZ)



- Split phase
- Class A Insulation
- Manual reset thermal protection
- Reversible rotation by electrical reconnection
- 20" leads included
- NEMA 48 Frame

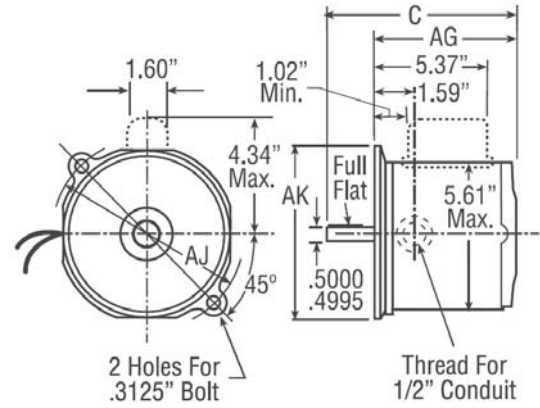

SINGLE PHASE

MOTOR Part No.	HP	VOLTAGE	FLA	BRGS.	RPM/SPEED(S)	TEMP RISE	DIMENSIONS (IN.)				
							C	AG	AJ	AK	HZ
P267-9782*	1/8	115	2.9	SLV	1725	40° C	7.40	5.34	7.25	6.38	60
P267-9783**	1/7	115	2.4	SLV	3450	40° C	7.15	5.12	6.75	5.50	60
P267-9784*	1/6	115	3.3	SLV	1725	40° C	7.60	5.54	7.25	6.38	60

* Motor leads - 21 inches long, 18 gauge. ** Motor leads -24" long #18 50 2-conductor out shell at 11 o'clock position.



UNIVERSAL REPLACEMENT PROPELLERS

UNIVERSAL REPLACEMENT PROPELLERS INFORMATION

GENERAL INFORMATION

The simplest form of an axial fan consists of a propeller, usually with three to five aluminum blades mounted in a venturi. This type of fan finds wide use in applications requiring high air volumes at low static pressures. The performance characteristics of propellers may vary in many ways. Some general guidelines are:

- Increased blade pitch increases CFM and HP
- Decreased blade pitch decreases CFM and HP
- Increasing the number of blades increases static pressure characteristics

ADVANTAGES OF PROPELLERS

- Straight through air flow pattern
- Low cost
- Light weight
- High volume

TYPICAL APPLICATIONS

- Roof Top Unit Heaters
- Condensing Units
- Walk-In Refrigeration Units
- Pedestal Fans, Mancoolers, Ventilating Fans

BLADE SHAPE

There are only three basic shapes that are of interest in the propeller selection - round, wide pressure blade and narrow pressure blade.



Round

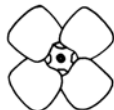

Wide

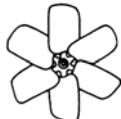

Narrow

The round blades are used for free air delivery and low pressure applications, and are quieter.

The wide pressure blade is used in most applications operating at substantial static pressures. It has excellent pressure characteristics and reasonable noise levels.

The narrow pressure blade is generally used in applications where higher static pressure exists, such as multi-row coils or places where minimum axial depth is necessary.

PROPS FOR THE REPLACEMENT BUSINESS

BOTH FREE AIR AND CONDENSER DESIGNS

- 2-, 3-, 4-, 5-, and 6-Blade Propellers
- Up to 60" in diameter, up to 40° pitches
- Hubs and Bushings: 1/4" to 1 7/16" bore

WHY INSTALL A NEW PROPELLER?

Propeller balance is sensitive and can be negatively affected by slight pressure. Simply resting the motor and propeller assembly on the ground after disassembly from a condensing unit may result in an unbalanced propeller. This is especially true of original equipment propellers, as they are constructed of lighter gauge material. If a puller must be used to remove a prop from a motor shaft, it is very likely that the propeller will be distorted from the pressure.



PROPELLER VIBRATION

Propellers are, by nature, rather flexible and subject to vibration. Commercially available propellers will have a number of natural frequencies occurring as different parts of the propeller vibrate, or as they vibrate in different modes. Lau exercises great care in designing propellers so natural frequencies do not occur at frequencies normally found in systems.

PITCH SELECTION

A pitch gauge is used to measure the pitch and rotation of a propeller.

- Pitch is measured at the spider lobe
- Consult the chart for pitch selection to avoid motor overload
- Make certain that the propeller horsepower does not exceed the motor horsepower
- On "Free Air" type propellers, use the brake horsepower published under the RPM in the performance chart
- On "Condenser" type applications, where static pressure is unknown, use the brake horsepower published at .3" static pressure for the appropriate RPM

IDENTIFYING PROPELLER ROTATION

- The direction of rotation of a propeller is determined to be clockwise (CW) or counter-clockwise (CCW) when viewed from the air discharge side (the cupped side of the blade)
- The discharge side is the concave ("cupped") side of the blade

EASY "SANDBOX METHOD" METHOD OF DETERMINING ROTATION

- Imagine standing in a sandbox and dropping the propeller face up or face down on the sand. Regardless of which side is up, the direction of rotation is the same as the direction required to turn the propeller into the sand

Specifications are subject to change without notice or obligation.

UNIVERSAL REPLACEMENT PROPELLERS

UNIVERSAL REPLACEMENT PROPELLERS INFORMATION

REPLACING A PROPELLER

1. Disconnect electrical power
2. Note the location fo the current propeller in the unit. Remove current propeller from motor shaft with the proper type of puller
3. Remove burrs and/or rust from motor shaft
4. Locate interchangeable hub on desired side of propeller. Attach hub to propeller with three screws. Tighten screws to approximately 30 in-lbs
5. Place propeller on motor shaft in the unit, place the propeller in approximately the same position as the old propeller
6. Make sure that the propeller will be rotating in the correct direction
7. Fasten the propeller to the motor shaft by tightening set screws securely. Be sure to align setscrew on flat of the motor shaft
8. Rotate the propeller by hand to make sure that the blades clear any obstructions by at least 1/4"

HOW TO REPLACE A 3-BLADE PROPELLER WITH A 4 OR 5-BLADE PROPELLER

1. Find the closest match to current blade from the data in the catalog
 - Match number of blades of the original propeller you are replacing
 - Match diameter of the original blade you are replacing
 - Match pitch (as closely as possible) to the original blade you are replacing
 - Check direction of rotation
2. Check current motor RPM for the existing blade
3. Check the Lau catalog technical data for the closest matching 3-blade replacement propeller's CFM and HP required
4. Find a propeller with same diameter and a different number of blades
5. Following the row for the motor's speed, find a propeller with CFM closest to original blade
 - Make sure the CFM is equal or greater to CFM of the blade you are replacing
 - **DO NOT** replace existing blade with a propeller that has a lower CFM
6. Ensure new blade's HP required is less than the nameplate rating of the motor.
 - If BHP exceeds nameplate rating, use prop with less CFM until HP is under nameplate rating on motor

▲ Safety Tips:

Avoid personal injury and/or equipment damage.

Do not exceed recommended RPM shown in charts.

Lau propellers are 100% inspected and precision balanced. Identification labels are applied to blades **BEFORE** balancing. Removal of a Lau label and/or adding additional labels to propeller blades can affect balance.

DID YOU KNOW?

You can replace a 3-blade condenser fan with a 4-blade or 5-blade fan. If you do this, choose a replacement that matches the CFM required as nearly as possible. Ensure the brake HP required **does not** exceed the nameplate rating of the motor.

NOTE: If minimum HP required for a fan blade is .501 the motor must be more than 1/2 HP motor.

HORSEPOWER CONVERSION CHART

Use to convert decimal horsepower to commonly available fractional horsepower motors.
(For watt conversion, use the formula 745.7 watts = 1 HP)

Decimal Horsepower																	
0.010	0.014	0.017	0.020	0.025	0.033	0.040	0.050	0.067	0.083	0.100	0.125	0.167	0.250	0.333	0.500	0.750	1.000
Fractional Horsepower																	
1/100	1/70	1/60	1/50	1/40	1/30	1/25	1/20	1/15	1/12	1/10	1/8	1/6	1/4	1/3	1/2	3/4	1



UNIVERSAL REPLACEMENT PROPELLERS

HUB AND HUBLESS TYPE PROPELLERS



HUB TYPE



HUBLESS TYPE



HUBLESS TYPE

- Hub and Hubless Types
- 3-, 5-, and 6-Blade Designs
- 5 1/2" - 10" Diameters
- 1/4" and 5/16" Bores
- CW and CCW Rotations
- High Quality Aluminum Blades

TYPICAL APPLICATIONS

- Air Moving – heating or cooling
- Fan Coils
- Freezers
- Refrigerators
- Refrigerated Display Cases
- Heaters
- Ventilators
- Range Hoods
- Small Appliances

WITH ALUMINUM FIXED HUB

Part No.	Blades	Dia.	Bore	Pitch	Rotation	Depth	RPM	Max. Pack	Std. Wt.
60834601 60834701	6	5 1/2"	1/4"	45°	CW CCW	1 1/2"	3450	4	1.0
60834801 60834901	5	7"	1/4"	27°	CW CCW	1 1/2"	3600	4	1.0
60835001 60835101	5	7"	5/16"	27°	CW CCW	1 1/2"	3600	4	1.0
60835201 60835301	5	8"	1/4"	24°	CW CCW	1 1/6"	3600	4	1.2
60835401 60835501	5	8"	1/4"	30°	CW CCW	1 5/8"	3600	4	1.2
60835601 60835701	5	8"	5/16"	18°	CW CCW	1 1/16"	3600	4	1.2
60835801 60835901	5	8"	5/16"	23°	CW CCW	1 5/16"	3600	4	1.2
60836201 60836301	5	9"	5/16"	26°	CW CCW	1 1/4"	3000	4	1.4
60836601 60836701	5	10"	1/4"	31°	CW CCW	1 5/8"	2400	4	2.0
60836801 60836901	5	10"	5/16"	20°	CW CCW	1 1/8"	2400	4	2.0
60837001 60837101	5	10"	5/16"	31°	CW CCW	1 5/8"	2400	4	2.0

CW Rotation: Hub on Intake Side. CCW Rotation: Hub on Discharge Side.

HUBLESS TYPE PROPELLERS

Part No.	Blades	Dia.	Pitch	Rotation	Depth	RPM	Pack
60838201	3	7 3/4"	30°	CW	2 9/16"	1550	4
60839701	3	8 3/4"	23°	CW	2 1/4"	1550	4
60838301	3	8 3/4"	32°	CW	3"	1550	4
60838401	3	10"	24°	CW	2 5/8"	1550	4
60837201	5	7"	20°	CW	1"	3600	4
60837301	5	7"	31°	CW	1 1/2"	3600	4
60837401	5	7 3/4"	20°	CW	1 1/8"	3600	4
60837501	5	7 3/4"	31°	CW	1 11/16"	3600	4
60837601	5	8"	24°	CW	1"	3600	4
60837701	5	8"	31°	CW	1 5/8"	3600	4
60837801	5	9"	20°	CW	1"	3000	4
60837901	5	9"	31°	CW	1 5/8"	3000	4
60838001	5	10"	20°	CW	1"	2400	4
60838101	5	10"	31°	CW	1 5/8"	2400	4

CW Rotation: Hub on Intake Side.

Used on equipment manufactured by well known OEMs such as Copeland, Tecumseh, Larkin Coils, Witt, Whirlpool, G.E., Carrier, Heil-Quaker, Nutone, Borg-Warner, Tappan, Amana, BDP, Barber-Colman, Emerson, Scotsman, Vendo and Beverage Air.

INTERCHANGEABLE HUBS FOR HUBLESS PROPELLERS

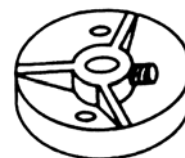

Lau Part No.	Bore
05382501	1/4"
05382502	5/16"

Specifications are subject to change without notice or obligation.

UNIVERSAL REPLACEMENT PROPELLERS

FIXED HUB PROPELLERS



- 14" - 24" diameters
- High strength aluminum blades
- Each propeller clearly labeled as to pitch, diameter, rotation and maximum RPM
- Available for immediate delivery from stock
- Top quality, epoxy painted spiders with high salt spray characteristics
- Steel Fixed Hub - 1/2" bore – exact propellers supplied to OEMs (no need for interchangeable hub feature since all Lau OEMs use 1/2" bore only)

TYPICAL APPLICATIONS

- For lower static pressure condensing units
- Well-known OEMs such as, G.E., Rheem-Rudd, Singer-Climate Control, Trane, etc.

2-BLADE WITH 1/2" BORE

Part No.	Rot. Hub Loc.*	Dia. ("")	Pitch	RPM	Static Pressure										Pack	
					.0" WC		.1" WC		.2" WC		.3" WC		.4" WC			
					CFM	HP	CFM	HP	CFM	HP	CFM	HP	CFM	HP		
60743401	CW,D	14"	36°	825	1067	.27	689	.035	-	-	-	-	-	-	-	2
				1075	1391	.061	1145	.068	742	.083	-	-	-	-	-	
				1140	1475	.072	1248	.080	913	.094	399	.120	-	-	-	
				1550	2005	.0182	1850	.191	1667	.202	1442	.219	1134	.244	-	
				1625	2102	.210	1956	.219	1785	.230	1582	.247	1321	.269	-	
60772501	CCW,I	18"	28°	830	2003	.061	1569	.070	668	.082	-	-	-	-	2	
				1075	2572	.122	2219	.131	1799	.146	984	.160	606	.197		
				1140	2768	.144	2394	.155	2093	.174	1189	.177	814	.215		
60652101	CCW,I	18"	33°	830	2217	.078	1758	.090	748	.103	-	-	-	-	2	
				1075	2841	.154	2491	.165	2124	.189	1080	.201	707	.245		
				1140	3015	.187	2667	.199	2380	.223	1310	.219	884	.268		
60772601	CCW,I	20"	28°	830	2375	.085	1775	.095	1025	.100	400	.120	-	-	2	
				1000	2861	.148	2410	.161	1777	.168	1175	.184	-	-		
				1140	2774	.155	2376	.181	2019	.197	1607	.207	-	-		
60772701	CCW,I	22"	16°	830	2325	.060	1425	.070	450	.100	-	-	-	-	2	
				1000	2800	.105	2024	.110	1289	.138	452	.210	-	-		
				1140	3193	.155	2541	.158	1889	.181	1188	.218	-	-		
60814201	CCW,I	22"	27°	830	3250	.095	2650	.113	1815	.130	1250	.148	-	-	2	
				1000	3910	.160	3400	.188	2890	.210	2100	.226	-	-		
				1140	4450	.240	4020	.270	3570	.298	3060	.320	-	-		
60772801	CCW,I	24"	27°	830	4136	.151	3504	.175	2358	.186	899	.240	-	-	2	
				1075	5299	.300	4753	.318	4346	.360	3785	.393	1845	.416		
				1140	5647	.367	5015	.370	4645	.418	4202	.460	2254	.456		

CW,D – Clockwise Rotation, hub on Discharge side of propeller. CCW, I – Counter-Clockwise Rotation, hub on Intake side of propeller.

▲ Safety Tips:

Avoid personal injury and/or equipment damage.

Do not exceed recommended RPM shown in charts.

Lau propellers are 100% inspected and precision balanced. Identification labels are applied to blades BEFORE balancing. Removal of a Lau label and/or adding additional labels to propeller blades can affect balance.

Why Risk a Callback?



When replacing a PSC motor, always replace the capacitor and insist on a Lau Universal Replacement Propeller to assure years of service from the motor you install today!

TOTALINE

UNIVERSAL REPLACEMENT PROPELLERS

HEAVY DUTY CONDENSER TYPE PROPELLERS



- 3-blade configuration is normally used in low pressure applications
- 4 and 5-blade configurations are suited for higher static pressures
- Square pressure-type blades are required for most condenser applications
- High quality aluminum blades
- Interchangeable hubs available from 1/4" through 3/4" bore, may be attached on either intake or discharge side (purchase separately)
- Pitches available for most common horsepower and motor speeds up to 1725 RPM in both CW and CCW rotations
- Each propeller clearly labeled as to pitch, diameter, rotation and maximum RPM
- Available for immediate delivery from stock

TYPICAL APPLICATIONS

- Air Conditioning Condensers
- Power Roof Ventilators
- Heat Pumps
- Heat Exchangers
- Roof Top Air Conditioners
- Commercial and Industrial Equipment
- Unit Heaters
- Agricultural Ventilation Equipment
- Walk-in Refrigeration Units
- General Cooling/Heating Applications

3-BLADE PROPELLERS

Part No.	Rot. Hub Loc.*	Dia. (")	Pitch	RPM	Static Pressure										Pack
					.0" WC		.1" WC		.2" WC		.3" WC		.4" WC		
					CFM	HP	CFM	HP	CFM	HP	CFM	HP	CFM	HP	
60265201	CW	10"	27°	1075	443	.013	213	.018	96	.019					2
60265301	CCW	10"	27°	1140	471	.016	255	.020	115	.027					
				1550	632	.027	508	.034	335	.040	229	.048	210	.065	
60716101	CW	12"	19°	1075	559	.015	309	.021	169	.026					2
60716201	CCW	12"	19°	1140	587	.017	378	.023	204	.028					
				1550	800	.032	674	.040	490	.047	353	.055	210	.061	
60716301	CW	12"	23°	1075	720	.019	543	.027	263	.033					2
60716401	CCW	12"	23°	1140	769	.022	608	.029	327	.037	162	.041	407	.084	
				1550	1037	.045	936	.053	792	.064	543	.075	555	.105	
60716501	CW	14"	23°	1075	1060	.031	806	.041	499	.053					2
60716601	CCW	14"	23°	1140	1120	.035	893	.047	602	.058	397	.074	757	.134	
				1550	1512	.071	1395	.086	1172	.102	927	.116	947	.167	
60716701	CW	14"	27°	1075	1211	.037	951	.047	610	.060	338	.077			2
60716801	CCW	14"	27°	1140	1275	.046	1065	.057	723	.069	485	.087	895	.169	
				1550	1717	.103	1586	.117	1388	.133	1116	.149	1185	.199	
60716901	CW	16"	19°	1075	1415	.046	1218	.057	774	.071	518	.085			2
60717001	CCW	16"	19°	1140	1500	.053	1322	.063	962	.079	641	.093	413	.107	
				1550	2014	.111	1890	.125	1751	.142	1555	.161	1187	.181	
60717101	CW	16"	23°	1075	1613	.054	1432	.068	1080	.083	689	.101	349	.112	2
60717201	CCW	16"	23°	1140	1725	.062	1556	.076	1234	.091	806	.110	562	.128	
				1550	2299	.140	2181	.158	2044	.178	1860	.200	1556	.222	
60556101	CW	18"	27°	830	2138	.068	1741	.083	970	.097	597	.122			2
60556201	CCW	18"	27°	1075	2736	.131	2489	.142	2182	.169	1464	.187	1057	.211	
				1140	2910	.155	2664	.164	2399	.192	1900	.220	1269	.237	
				1625	3957	.390	3776	.392	3595	.417	3409	.454	3189	.495	
				1725	4404	.537	4243	.536	4078	.559	3916	.595	3742	.638	
60556301	CW	18"	30°	825	2236	.080	1820	.093	1028	.110	640	.138			2
60556401	CCW	18"	30°	1075	2908	.164	2596	.166	2256	.199	1582	.220	1136	.244	
				1140	3066	.189	2804	.195	2524	.226	2022	.257	1351	.274	
				1625	4370	.548	4192	.540	4003	.564	3817	.605	3612	.652	
				1725	4639	.656	4475	.644	4293	.666	4119	.706	3936	.754	

NOTE: Order Hubs separately see page 24

Specifications are subject to change without notice or obligation.

UNIVERSAL REPLACEMENT PROPELLERS

HEAVY DUTY CONDENSER TYPE PROPELLERS

3-BLADE PROPELLERS - CONTINUED

Part No.	Rot. Hub Loc.*	Dia. (")	Pitch	RPM	Static Pressure										Pack
					.0" WC		.1" WC		.2" WC		.3" WC		.4" WC		
					CFM	HP	CFM	HP	CFM	HP	CFM	HP	CFM	HP	
60556501 60556601	CW CCW	18" 18"	33° 33°	825 1075 1140 1625 1725	2453 3127 3321 4588 4870	.095 .197 .229 .570 .682	2032 2857 3063 4448 4740	.105 .193 .229 .583 .695	1209 2534 2765 4292 4595	.122 .223 .259 .605 .717	746 1802 2174 4109 4432	.149 .249 .292 .637 .784	1252 1483 3882 4237	.271 .306 .676 .786	2
60556701	CW CCW	20" 20"	27° 27°	850 1000 1140	2500 2970 3360	.072 .115 .170	2100 2600 3070	.085 .135 .200	1460 2170 2700	.105 .155 .230	950 1600 2280	.122 .175 .250			2
60556901 60557001	CW CCW	20" 20"	30° 30°	850 1000 1140	2750 3250 3700	.100 .140 .220	2400 3000 3480	.110 .157 .240	1740 2400 3150	.125 .190 .253	1150 1850 2660	.150 .210 .300			2
60557101 60557201	CW CCW	20" 20"	33° 33°	850 1000 1140	2950 3500 4000	.110 .175 .250	2570 3170 3700	.120 .190 .270	1850 2550 3400	.140 .217 .300	1300 2000 2860	.170 .240 .350			2
60557301 60557401	CW CCW	22" 22"	27° 27°	850 1000 1140	3930 4700 5330	.200 .340 .500	3650 4400 5100	.220 .360 .530	3200 4050 4800	.240 .380 .570	2500 3600 4500	.275 .400 .620			2
60557501 60557601	CW CCW	22" 22"	33° 33°	850 1000 1140	4600 5450 6200	.300 .490 .720	4250 5150 5950	.330 .510 .753	3800 4800 5600	.360 .522 .810	3100 4380 5300	.380 .553 .850			2
60557701 60557801	CW CCW	24" 24"	27° 27°	825 1075 1140 1625	4844 6277 6632 9151	.237 .492 .583 1.533	4302 5834 6170 8669	.241 .492 .584 1.481	3855 5518 5872 8427	.286 .537 .633 1.536	1819 5195 5588 8229	.315 .590 .688 1.605	1247 4769 5267 8049	.384 .643 .742 1.679	2
60557901 60558001	CW CCW	24" 24"	33° 33°	825 1075 1140 1625	5335 6956 7538 10072	.300 .640 .747 1.857	4708 6432 6889 9698	.307 .635 .725 1.885	4244 6092 6550 9421	.364 .688 .780 1.949	1931 5758 6233 9194	.395 .747 .848 2.017	1444 5346 5877 8985	.472 .803 .919 2.087	2

NOTE: Order Hubs separately see page 24



UNIVERSAL REPLACEMENT PROPELLERS

HEAVY DUTY CONDENSER TYPE PROPELLERS



10"



12" - 14"



16" - 20"



22" - 24"



26"

4-BLADE PROPELLERS

Part No.	Rot. Hub Loc.*	Dia. (")	Pitch	RPM	Static Pressure										Pack
					.0" WC		.1" WC		.2" WC		.3" WC		.4" WC		
					CFM	HP	CFM	HP	CFM	HP	CFM	HP	CFM	HP	
60717301 60717401	CW CCW	10"	19°	825	432	.012	309	.017	-	-	-	-	-	-	2
				1075	563	.027	477	.033	361	.038	-	-	-	-	
				1140	597	.033	516	.039	416	.044	-	-	-	-	
				1550	812	.082	754	.091	692	.099	623	.107	536	.113	
1625	857	.095	796	.104	738	.113	624	.121	598	.128					
60717501 60717501	CW CCW	10"	23°	1075	402	.012	220	.017	132	.023					2
				1140	429	.016	271	.021	154	.026					
				1550	580	.025	479	.032	333	.038	252	.046	193	.054	
				1725	646	.033	557	.041	422	.047	330	.056	277	.064	
60717701 60717801	CW CCW	10"	27°	1140	580	.011	366	.023	209	.018					2
				1550	788	.027	600	.029	440	.033	350	.040			
				1725	877	.037	723	.039	587	.042	462	.049			
				1075	535	.019	334	.027	231	.035					
60759901 60760001	CW CCW	10"	33°	1140	564	.022	365	.027	231	.035				2	
1550				771	.045	635	.050	497	.058	398	.069				
1725				856	.057	771	.064	607	.069	519	.080	437	.092		
1075				586	.019	410	.025	273	.031	168	.035				
60717901 60718001	CW CCW	12"	19°	1140	623	.020	471	.027	318	.033	228	.039		2	
1550				839	.042	746	.051	613	.060	495	.069	415	.077		
1725				929	.054	841	.064	725	.074	612	.085	537	.094		
1075				731	.022	569	.029	345	.037	28	.044				
60718101 60718201	CW CCW	12"	23°	1140	773	.024	640	.033	414	.042	290	.049		2	
1550				1045	.048	969	.061	824	.074	644	.086	534	.095		
1725				1162	.065	1095	.088	994	.108	831	.105	690	.117		
1075				822	.023	683	.032	422	.040	272	.048				
60718301 60718401	CW CCW	12"	27°	1140	872	.030	725	.039	489	.048	341	.057		2	
1550				1171	.060	1100	.071	983	.084	762	.100	610	.122		
1725				1302	.081	1233	.092	1136	.107	973	.124	794	.139		
1075				953	.032	808	.041	488	.052	326	.062				
60760101 60760201	CW CCW	12"	33°	1140	1015	.040	902	.047	565	.060	408	.071		2	
1550				1369	.087	1292	.096	1161	.110	919	.129	745	.144		
1725				1508	.119	1447	.127	1356	.140	1172	.163	943	.184		
1075				970	.023	772	.035	492	.045	344	.055				
60718501 60718601	CW CCW	14"	19°	1140	1030	.029	853	.040	576	.050	413	.063	264	.073	2
1550				1380	.066	1281	.080	1134	.095	899	.108	731	.123		
1725				1523	.088	1445	.104	1332	.119	1134	.133	926	.149		
1075				1143	.035	982	.047	628	.059	448	.072	252	.081		
60718701 60718801	CW CCW	14"	23°	1140	1216	.043	1075	.054	741	.069	535	.081	386	.093	2
1550				1643	.089	1564	.103	1452	.119	1248	.136	972	.154		
1725				1810	.123	1740	.139	1644	.155	1488	.171	1211	.190		
1075				1286	.046	1131	.055	737	.071	525	.087				
60718901 60719001	CW CCW	14"	27°	1140	1370	.054	1225	.064	843	.081	624	.096	440	.113	2
1550				1838	.125	1754	.138	1629	.153	1376	.173	1090	.198		
1725				2036	.167	1963	.180	1863	.197	1702	.218	1418	.244		
1075				1286	.046	1131	.055	737	.071	525	.087				

Specifications are subject to change without notice or obligation.

UNIVERSAL REPLACEMENT PROPELLERS

HEAVY DUTY CONDENSER TYPE PROPELLERS

4-BLADE PROPELLERS - CONTINUED

Part No.	Rot. Hub Loc.*	Dia. (")	Pitch	RPM	Static Pressure										Pack
					.0" WC		.1" WC		.2" WC		.3" WC		.4" WC		
					CFM	HP	CFM	HP	CFM	HP	CFM	HP	CFM	HP	
60760301	CW	14"	33°	1075	1448	.061	1241	.069	858	.089	596	.105			2
60760401	CCW	14"	33°	1140	1531	.076	1341	.085	940	.108	709	.125	517	.143	
				1550	2077	.179	1972	.185	1811	.200	1521	.228	1240	.255	
				1725	2298	.234	2208	.245	2086	.260	1891	.282	1598	.312	
60719101	CW	16"	19°	1075	1405	.045	1231	.059	919	.075	646	.089	490	.102	2
60719201	CCW	16"	19°	1140	1482	.049	1332	.065	1098	.079	766	.093	562	.109	
				1550	1960	.113	1864	.131	1740	.151	1564	.171	1324	.192	
				1725	2161	.142	2077	.166	1975	.189	1841	.213	1657	.235	
60719301	CW	16"	19°	1075	1671	.064	1527	.078	1251	.096	845	.113	637	.133	2
60719201	CCW	16"	19°	1140	1774	.072	1638	.087	1410	.107	1018	.126	784	.144	
				1550	2365	.169	2268	.189	2156	.210	2016	.233	1815	.258	
				1725	2602	.218	2518	.239	2422	.263	2307	.290	2158	.321	
60719501	CW	16"	27°	1075	1896	.087	1747	.099	1498	.120	1018	.140	754	.158	2
60719601	CCW	16"	27°	1140	1997	.100	1872	.115	1653	.133	1237	.154	934	.175	
				1550	2677	.229	2593	.244	2488	.263	2348	.288	2123	.319	
				1725	2959	.314	2879	.327	2789	.346	2682	.369	2547	.397	
60760501	CW	16"	33°	1075	2013	.110	1852	.119	1469	.139	1123	.164	873	.188	2
60760601	CCW	16"	33°	1140	2134	.123	1963	.131	1611	.154	1277	.183	1038	.209	
				1550	2882	.299	2782	.308	2655	.327	2501	.355	2296	.390	
				1725	3201	.397	3107	.405	2988	.422	2851	.449	2684	.483	
60800201	CW	18"	23°	825	1918	.053	1678	.068	1027	.085	663	.103			2
60800301	CCW	18"	23°	1075	2491	.105	2291	.121	2060	.147	1595	.173	1117	.190	
				1140	2614	.126	2450	.142	2252	.168	1900	.199	1325	.217	
				1625	3624	.319	3508	.335	3388	.361	3259	.393	3111	.431	
				1725	3847	.382	3738	.398	3626	.424	3508	.456	3377	.494	
60558101	CW	18"	27°	825	2115	.068	1855	.082	1205	.102	765	.124			2
60558201	CCW	18"	27°	1075	2690	.136	2502	.157	2240	.188	1657	.216	1212	.236	
				1140	2873	.167	2702	.179	2495	.205	2174	.239	1465	.263	
				1625	3960	.408	3855	.426	3740	.451	3609	.484	3454	.523	
				1725	4204	.488	4105	.507	3998	.532	3880	.565	3745	.603	
60558301	CW	18"	30°	825	2241	.078	1942	.093	1244	.114	799	.138			2
60558401	CCW	18"	30°	1075	2886	.172	2699	.179	2461	.204	1954	.238	1289	.259	
				1140	3045	.194	2869	.206	2654	.234	2295	.270	1521	.290	
				1625	4231	.487	4122	.503	4003	.529	3873	.563	3727	.603	
				1725	4491	.583	4389	.599	4278	.625	4160	.659	4029	.699	
60558501	CW	18"	33°	825	2433	.100	2055	.113	1391	.135	862	.157			2
60558601	CCW	18"	33°	1075	3130	.208	2934	.214	2648	.240	2047	.274	1513	.297	
				1140	3309	.247	3089	.242	2828	.272	2458	.316	1750	.340	
				1625	4623	.638	4501	.634	4350	.650	4188	.683	4001	.730	
				1725	4907	.763	4796	.758	4655	.771	4506	.802	4341	.846	
60800401	CW	20"	23°	850	2235	.056	1830	.075	1400	.090	1060	.105			2
60800501	CCW	20"	23°	1000	2630	.091	2280	.117	1930	.135	1560	.160			
				1140	3000	.135	2700	.160	2400	.190	2100	.207			
60558701	CW	20"	27°	850	2590	.090	2180	.103	1700	.130	1300	.142			2
60558801	CCW	20"	27°	1000	3000	.150	2680	.162	2300	.180	1900	.200			
				1140	3420	.196	3120	.230	2800	.255	2450	.280			
60558901	CW	20"	30°	850	2800	.110	2490	.128	1900	.145	1500	.170			2
60559001	CCW	20"	30°	1000	3300	.180	3020	.200	2650	.220	2150	.240			
				1140	3770	.260	3510	.290	3215	.310	2830	.335			
60559101	CW	20"	33°	850	3120	.130	2700	.150	2040	.165	1610	.195			2
60559201	CCW	20"	33°	1000	3660	.210	3330	.235	2850	.260	2300	.282			
				1140	4160	.315	3900	.340	3520	.360	3020	.390			

NOTE: Order Hubs separately see page 24



UNIVERSAL REPLACEMENT PROPELLERS

HEAVY DUTY CONDENSER TYPE PROPELLERS

4-BLADE PROPELLERS - CONTINUED

Part No.	Rot. Hub Loc.*	Dia. (")	Pitch	RPM	Static Pressure								Pack		
					.0" WC		.1" WC		.2" WC		.3" WC			.4" WC	
					CFM	HP	CFM	HP	CFM	HP	CFM	HP		CFM	HP
60804101 60804201	CW CCW	22" 22"	23° 23°	850 1000 1140	3300 3870 4410	.150 .245 .360	3070 3700 4270	.175 .275 .395	2760 3450 4090	.200 .305 .430	2340 3150 3850	.220 .330 .460			2
60559301 60559401	CW CCW	22" 22"	27° 27°	850 1000 1140	3900 4580 5220	.208 .330 .500	3650 4400 5050	.230 .365 .520	3280 4100 4840	.255 .395 .565	2800 3780 4580	.280 .427 .600			2
60559501 60559601	CW CCW	22" 22"	33° 33°	850 1000 1140	4460 5250 6000	.300 .480 .710	4200 5050 5800	.322 .520 .760	3830 4780 5600	.350 .552 .800	3100 4400 5320	.375 .580 .830			2
60804301 60804401	CW CCW	24" 24"	23° 23°	825 1075 1140 1625	4188 5457 5728 7742	.187 .413 .484 1.266	3829 5112 5466 7504	.213 .408 .506 1.252	3415 4857 5217 7296	.258 .453 .550 1.290	2262 4611 4962 7124	.292 .508 .601 1.345	1550 4322 4662 6964	.334 .567 .655 1.408	2
60559701 60559801	CW CCW	24" 24"	27° 27°	825 1075 1140 1625	4958 6329 6735 9042	.262 .535 .627 1.548	4570 6081 6450 8848	.281 .565 .673 1.642	4103 5829 6194 8670	.328 .607 .723 1.705	2761 5546 5930 8496	.365 .657 .774 1.769	1904 5183 5629 8323	.414 .711 .825 1.835	2
60559901 60560001	CW CCW	24" 24"	33° 33°	825 1075 1140 1625	5879 7519 7943 10763	.376 .806 .935 2.312	5526 7293 7669 10586	.402 .827 .965 2.359	5041 7029 7391 10412	.444 .864 1.103 2.416	3560 6700 7089 10237	.484 .919 1.071 2.481	2322 6235 6733 10059	.522 .988 1.137 2.553	2
60760701 60760801	CW CCW	26" 26"	24° 24°	850 1000 1140	5440 6400 7300	.333 .540 .810	5200 6200 7120	.375 .590 .860	4900 6000 6930	.412 .630 .910	4500 5700 6720	.448 .680 .960			1

PROPELLER ACCESSORIES

INTERCHANGEABLE HUBS

For use on all 3-Blade, 4-Blade and 5-Blade propellers



HEX/Round Hubs

(includes set and mounting screws)

Part No.	Bore	Setscrews
60765801	1/4"	1
60765802	5/16"	1
60765803	3/8"	1
60765804	1/2"	2
60765805	5/8**	2
60765806	3/4**	2

*with keyway

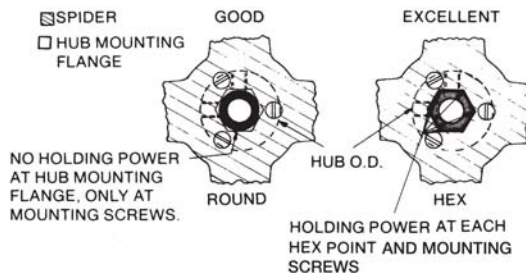

- All steel with extra metal in the two mounting surfaces (hex and round) for more secure fit in multiple applications
- Hex on one side, round on the other (may use either side) - one inventory for all propellers
- Zinc-plated, coated with gold chromate for double protection
- Setscrews are heat-treated, black oxide
- Mounting screws: zinc-plated, heat-treated, pan-slotted - with locking serrations under the head - with nylock patch for added locking strength (double locking device designed to grip into the threads without backing out)
- 5/8" and 3/4" have keyway with extended body length for increased strength
- Can be ordered in boxes of 12 or individually

SETSCREWS



Allen Head Setscrews

Part No.	Recommended Description	Seating Torque	Pkg.
05055001	1/4-28 x 1/2"	70 In-lbs.	12
05055002	5/16-24 x 5/8"	130 In-lbs.	12

TECHNICAL TIP:

Lau HEX design takes the torque off the screws and puts it on the hub and spider - where it belongs!

BLOWER WHEELS

DOUBLE INLET BLOWER WHEELS



ALUMINUM WITH STEEL HUBS (4 3/4" - 7 1/2" DIAMETER)

Part No.	Dia.	Width	Rotation	Bore	RPM
02895808	4 3/4"	5 1/8"	CW	1/2"	3450
02895814	4 3/4"	5 1/8"	CCW	1/2"	3450
02895801	4 3/4"	6 7/8"	CW	1/2"	3450
02895815	4 3/4"	6 7/8"	CCW	1/2"	3450
02895802	5 1/4"	5 7/8"	CW	1/2"	3450
02895816	5 1/4"	5 7/8"	CCW	1/2"	3450
02895817	5 1/4"	6 3/4"	CCW	1/2"	3450
02895818	5 1/4"	6 3/4"	CW	1/2"	3450
02895803	5 1/4"	6 7/8"	CW	1/2"	3450
02895819	5 1/4"	6 7/8"	CCW	1/2"	3450
02895804	5 3/4"	5 7/8"	CW	1/2"	3450
02895820	5 3/4"	5 7/8"	CCW	1/2"	3450
02895805	5 3/4"	6 7/8"	CW	1/2"	3450
02895821	5 3/4"	6 7/8"	CCW	1/2"	3450
02895822	5 3/4"	7 5/8"	CW	1/2"	3450
02895823	5 3/4"	7 5/8"	CCW	1/2"	3450
02895824	5 3/4"	8"	CW	1/2"	3450
02895825	5 3/4"	8"	CCW	1/2"	3450
02895806	5 3/4"	8 1/2"	CW	1/2"	3450
02895826	5 3/4"	8 1/2"	CCW	1/2"	3450
02895827	6 5/16"	6 3/8"	CW	3/4"	3450
02895828	6 5/16"	6 3/8"	CCW	3/4"	3450
02895807	6 5/16"	7 5/8"	CW	1/2"	3450
02895829	6 5/16"	7 5/8"	CCW	1/2"	3450
02895832	7 1/2"	4"	CW	3/4"	2500
02895833	7 1/2"	4"	CCW	3/4"	2500
02895834	7 1/2"	5"	CW	3/4"	2500
02895835	7 1/2"	5"	CCW	3/4"	2500
02895836	7 1/2"	6 11/32"	CW	3/4"	1800
02895837	7 1/2"	6 11/32"	CCW	3/4"	1800

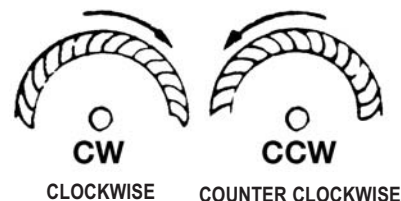

NOTE: To determine rotation for double wheels, view from hub.

TECHNICAL TIPS:

For other sizes: Double inlet wheels may be duplicated in the field by:

1. Using one CW and one CCW single wheel – may be different widths to make up space required, but diameters must be the same.
2. For wheels too close to apparatus to reach with driver, tighten wheels to shaft by using extended "T" Allen wrench inserted through a notch in one of the blades in each wheel.

CAUTION:

To avoid potential vibration, allow slight air gap (min. 1/32") between wheels.

Specifications are subject to change without notice or obligation.



BLOWER WHEELS

DOUBLE INLET BLOWER WHEELS

- 9" - 11" Double Inlet features a new design ensuring more precise blade spacing and improved consistency in alignment and balance
- Dynamically balanced, forward curved
- Incorporates Preslok® center disc construction for positive blade retention
- Provides higher RPM capability and industry proven reliability
- Offering the same outstanding features and high quality as Lau "A Series" Preslok® Wheels, "DD" Preslok® Wheels have a special hub for use with direct drive blowers
- All Standard Replacement Wheels are galvanized, cold-rolled steel
- Standard center disc arrangements shown

Rotation determined by viewing from hub side.

J = 1" on all models thru 11"
J = 11 5/16" on 12" models

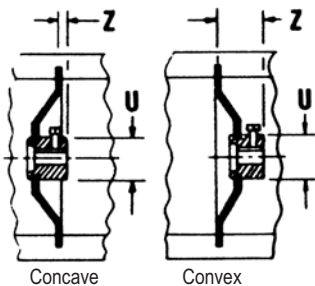
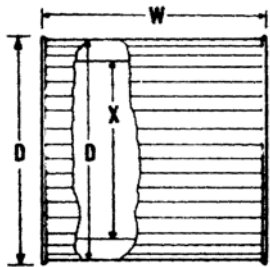
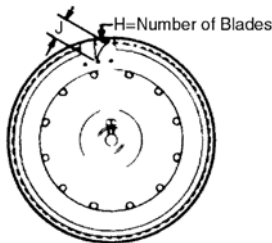

DIRECT DRIVE WHEELS (9" - 11" DIAMETER)

LAU UNIVERSAL REPLACEMENT "DD" PRESLOK® WHEELS FOR DIRECT DRIVE BLOWERS

Part No.	Bore Size	Rot.	Center Disc.	Max RPM	D	W	X	U	Z	H
01333401	1/2"	CW	Convex	1750	9 1/2	4 1/2	7 11/16	1 1/4	1 25/32	43
01333501	1/2"	CW	Convex	1750	9 1/2	6	7 11/16	1 1/4	1 25/32	43
01333602	1/2"	CW	Convex	1750	9 1/2	7 1/8	7 11/16	1 1/4	1 25/32	43
01333603	1/2"	CCW	Convex	1750	9 1/2	7 1/8	7 11/16	1 1/4	1 25/32	43
01333701	1/2"	CW	Convex	1750	9 1/2	8	7 11/16	1 1/4	1 25/32	43
01333703	1/2"	CCW	Convex	1750	9 1/2	8	7 11/16	1 1/4	1 25/32	43
01333201	1/2"	CW	Concave	1750	9 1/2	9 1/2	7 11/16	1 1/4	7/32	43
01333203	1/2"	CCW	Concave	1750	9 1/2	9 1/2	7 11/16	1 1/4	7/32	43
01332701	1/2"	CW	Convex	1750	11 1/8	4 1/2	8 7/8	1 1/4	1 15/16	48
01332601	1/2"	CW	Convex	1750	11 1/8	6	8 7/8	1 1/4	1 15/16	48
01332602	1/2"	CCW	Convex	1750	11 1/8	6	8 7/8	1 1/4	1 15/16	48
01332614	5/8"	CW	Convex	1750	11 1/8	6	8 7/8	1 1/4	1 15/16	48
01332501	1/2"	CW	Convex	1750	11 1/8	7 1/8	8 7/8	1 1/4	1 15/16	48
02710204	1/2"	CCW	Convex	1750	11 1/8	7 1/8	8 7/8	1 1/4	1 15/16	48
01332401	1/2"	CW	Convex	1750	11 1/8	8	8 7/8	1 1/4	1 15/16	48
01332402	1/2"	CCW	Convex	1750	11 1/8	8	8 7/8	1 1/4	1 15/16	48
01331701	1/2"	CW	Concave	1750	11 1/8	9 1/2	8 7/8	1 1/4	1/16	48
01331704	1/2"	CCW	Concave	1750	11 1/2	9 1/2	8 7/8	1 1/4	1/16	48
01332301	1/2"	CW	Convex	1750	11 1/8	9 1/2	8 7/8	1 1/4	1/16	48
01331602	1/2"	CW	Concave	1750	11 1/8	10 5/8	8 7/8	1 1/4	1/16	48
01332203	1/2"	CW	Convex	1750	11 1/8	10 5/8	8 7/8	1 1/4	1/16	48
01331606	1/2"	CCW	Concave	1750	11 1/8	10 5/8	8 7/8	1 1/4	1/16	48
02694003	1/2"	CW	Convex	1550	12 1/4	6	10	1 1/4		53
02694005	1/2"	CW	Convex	1550	12 1/4	7 1/8	10	1 1/4		53
02694007	1/2"	CW	Convex	1550	12 1/4	8	10	1 1/4		53
02694107	1/2"	CW	Concave	1550	12 1/4	8	10	1 1/4		53
02694008	1/2"	CCW	Convex	1550	12 1/4	8	10	1 1/4		53
02694009	1/2"	CW	Convex	1550	12 1/4	9 1/2	10	1 1/4		53
02694010	1/2"	CCW	Convex	1550	12 1/4	9 1/2	10	1 1/4		53
02694111	1/2"	CW	Concave	1550	12 1/4	10 5/8	10	1 1/4		53
02694112	1/2"	CCW	Concave	1550	12 1/4	10 5/8	10	1 1/4		53
01369325	1/2"	CW	Convex	1200	13 3/16	9 1/2	10 5/16	1 1/4	2	43
01369315	5/8"	CW	Convex	1200	13 3/16	9 1/2	10 5/16	1 1/4	2	43
01556507	1/2"	CW	Concave	1200	13 3/16	12 5/8	10 5/16	1 1/4	1/16	43
01556504	5/8"	CW	Concave	1200	13 3/16	12 5/8	10 5/16	1 1/4	1/16	43

TEMPERATURE: Due to temperature limitations of most motors, these wheels are recommended for application temperatures not exceeding 135°F (60°C). Wheels are rated to 200°F.

SERVICE TIP:

If opposite rotation is required, mount motor on hub side. Setscrew must be converted to Allen-head screw and then tightened through the blades, using "T" Allen wrench. (You may have to notch blade above setscrew to provide access for "T" Allen wrench.)

Specifications are subject to change without notice or obligation.

BLOWER WHEELS

DOUBLE INLET BLOWER WHEELS



- Galvanized, Universal Replacement Preslok® wheels with two hubs for CW or CCW rotation
- Highest quality blower wheel available for heating and air conditioning use
- Each blade is mechanically attached to the center disc by four steel fingers pressed through the hole in the blade for positive locking action
- End rings are of deep section and center disc is airflow shaped with increased hub spread. Highest maximum speed in the Lau wheel line
- **Maximum Operating Temperature - 200°F**

BELT DRIVE - A SERIES (9" - 20" DIAMETERS)

Part No.	G (Bore)	Set Screw	Key Way	Y	W	D	X	U	Z	H	Max. Wheel Cage RPM
00866612	3/4"	1	.19 x .09	9 1/2	6	9 1/2	7 11/16	1 1/4	2.94	43	4000
00862112	3/4"	1	.19 x .09	9 1/2	7 1/8	9 1/2	7 11/16	1 1/4	2.94	43	3300
00851912	3/4"	1	.19 x .09	9 1/2	9 1/2	9 1/2	7 11/16	1 1/4	2.94	43	2400
00851916	1"	1	.25 x 12	9 1/2	9 1/2	9 1/2	7 11/16	1 3/4	2.875	43	2400
01223712	3/4"	1	.19 x .09	10 5/8	4 1/2	10 5/8	8 7/8	1 1/4	3.28	48	3900
00836412	3/4"	1	.19 x .09	10 5/8	6	10 5/8	8 7/8	1 1/4	3.28	48	3900
00836312	3/4"	1	.19 x .09	10 5/8	7 1/8	10 5/8	8 7/8	1 1/4	3.28	48	3100
00836112	3/4"	1	.19 x .09	10 5/8	8	10 5/8	8 7/8	1 1/4	3.28	48	3000
00836212	3/4"	1	.19 x .09	10 5/8	9 1/2	10 5/8	8 7/8	1 1/4	3.28	48	2300
00836012	3/4"	1	.19 x .09	10 5/8	10 5/8	10 5/8	8 7/8	1 1/4	3.28	48	2100
00836010	5/8"	1	.19 x .09	10 5/8	10 5/8	10 5/8	8 7/8	1 1/4	3.28	48	2100
00836016	1"	1	.25 x 12	10 5/8	10 5/8	10 5/8	8 7/8	1 3/4	3.25	48	2100
00897116	1"	1	.25 x 12	13 3/16	6	12 5/8	10 5/16	1 3/4	3.5	43	3800
02757515	3/4"	1	.19 x .09	13 3/16	9 1/2	12 5/8	10 5/8	1 3/4	3.25	48	2100
00850716	1"	1	.25 x 12	13 3/16	9 1/2	12 5/8	10 5/16	1 3/4	3.5	43	2500
00850758	1 3/16"	1	.25 x 12	13 3/16	9 1/2	12 5/8	10 5/16	1 3/4	3.5	43	2500
00850723	1 7/16"	2	.38 x .19	13 3/16	9 1/2	12 5/8	10 5/16	2 1/2	3.88	43	2500
00986716	1"	1	.25 x 12	13 3/16	11 1/8	12 5/8	10 5/16	1 3/4	3.5	43	2000
00840310	5/8"	1	.19 x .09	13 3/16	12 5/8	12 5/8	10 5/16	1 1/4	3.375	43	1800
00840301	3/4"	1	.19 x .09	13 3/16	12 5/8	12 5/8	10 5/16	1 1/4	3.375	43	1800
00840316	1"	1	.25 x 12	13 3/16	12 5/8	12 5/8	10 5/16	1 3/4	3.5	43	1800
00840393	1 3/16"	1	.25 x 12	13 3/16	12 5/8	12 5/8	10 5/16	2 1/2	3.88	43	1800
00840379	1 7/16"	2	.38 x .19	13 3/16	12 5/8	12 5/8	10 5/16	2 1/2	3.88	43	1800
00874716	1"	1	.25 x 12	13 3/16	15	12 5/8	10 5/16	1 3/4	3.5	43	1100
00954816	1"	1	.25 x 12	15 1/2	9 1/2	15	12 5/8	1 3/4	4.12	51	2500
00954870	1 3/16"	2	.25 x 12	15 1/2	9 1/2	15	12 5/8	2 1/2	4.5	51	2500
00954823	1 7/16"	2	.38 x .19	15 1/2	9 1/2	15	12 5/8	2 1/2	4.5	51	2500
00841816	1"	1	.25 x 12	15 1/2	11 1/8	15	12 5/8	1 3/4	4.125	51	2100
00841877	1 3/16"	1	.25 x 12	15 1/2	11 1/8	15	12 5/8	1 3/4	4.125	51	2100
00841880	1 7/16"	2	.38 x .19	15 1/2	11 1/8	15	12 5/8	2 1/2	4.5	51	2100
00874616	1"	1	.25 x 12	15 1/2	12 5/8	15	12 5/8	1 3/4	4.125	51	1900
00827616	1"	1	.25 x 12	15 1/2	15	15	12 5/8	1 3/4	4.125	51	1550
01767137	1 3/16"	1	.25 x 12	15 1/2	15	15	12 5/8	1 3/4	4.125	51	1550
00827672	1 7/16"	2	.38 x .19	15 1/2	15	15	12 5/8	2 1/2	4.5	51	1550
00865916	1"	1	.25 x 12	18 5/8	13 1/2	18 1/8	14 11/16	1 3/4	5	48	1500
00865960	1 7/16"	1	.25 x 12	18 5/8	13 1/2	18 1/8	14 11/16	1 3/4	5	48	1500
00865816	1"	1	.25 x 12	18 5/8	18	18 1/8	14 11/16	1 3/4	5	48	1200
00865874	1 3/16"	1	.25 x 12	18 5/8	18	18 1/8	14 11/16	1 3/4	5	48	1200
00865887	1 7/16"	2	.38 x .19	18 5/8	18	18 1/8	14 11/16	2 1/2	5.375	48	1200
(A) 02553211	1 7/16"	1	.38 x .19	20 1/2	13 1/2	20	16 9/16	2 1/2	5.38	53	1300
(A) 02553207	1 7/16"	1	.38 x .19	20 1/2	15	20	16 9/16	2 1/2	5.38	53	1200
(A) 01954002	1 3/16"	1	.25 x 12	20 1/2	18	20	16 9/16	2 1/2	5.38	53	1100
(A) 01954041	1 7/16"	2	.38 x .19	20 1/2	18	20	16 9/16	2 1/2	5.38	53	1100
(A) 01954029	1 11/16"	1	.38 x .19	20 1/2	18	20	16 9/16	2 3/4	5.38	53	1100
(A) 01954020	2 15/16"	1	.50 x .25	20 1/2	18	20	16 9/16	4 1/4	5.38	53	1100
(A) 02043907*	3**	-	N/A	20 1/2	18	20	16 9/16	5 3/4	5.38	53	1100
(A) 02043920*	4**	-	N/A	20 1/2	18	20	16 9/16	7 1/8	5.38	53	1100

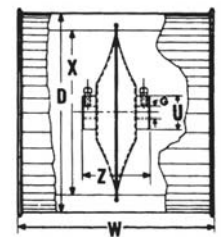
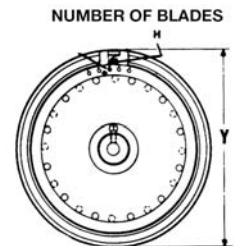

REDUCING BUSHINGS

For These Wheels Only



Used to reduce wheel bore sizes. A 1" bore wheel can be reduced to a 3/4" bore by using bushings with a 1" O.D. and a 3/4" I.D.

Model Description:

Bushing, 1" O.D. x 3/4" I.D. x 1 1/8" long

Part No.

027502-03

IMPORTANT:

Order the quantity of bushings to match number of hubs in the wheel.

SERVICE TIP: Use reducer bushings (one for each hub) if a smaller bore size is required.

(A) These wheels are a special order with 6-8 weeks lead time required and CANNOT ship by UPS.

* 1 3/16" and above diameter Clamplok hubs include tapped holes at 90° to keyway for accepting 2nd SS (supplied by installer).



BLOWER WHEELS

SINGLE INLET BLOWER WHEELS



- Galvanized steel construction (for plastic wheels, see Page 29)
- Replaces several OEM designs, as shown, and more
- Many can be bored to fit odd/larger sizes up to 5/8"
- Add bushings for smaller bore sizes (see Page 28)
- Allen head setscrews for easy reversibility
- Can combine two to replace double inlet wheels (see Technical Tips at the bottom, right of this page)
- **Maximum Operating Temperature - 200°F**

Lau's complete galvanized single inlet blower wheels are designed for easy serviceability and are built to last in the toughest of applications as well as to reduce SKUs.

TYPICAL APPLICATIONS

- Fan Coil Units
- Room Air Conditioners
- Draft Inducers
- Power Burners
- Heaters
- Packaged Terminal vAir Conditioners (PTAC) systems



COUNTER CLOCKWISE CLOCKWISE

ROTATION
Single inlet wheels
from closed end
(backplate)

TECHNICAL TIP:

Double inlet wheels may be duplicated in the field using *single* inlet wheels by:

1. Using one CW and one CCW single wheel back to back (may be different widths to make up space required, but diameters must be the same).
2. For wheels too close to apparatus to reach with a wrench, tighten wheels to shaft by using extended "T" Allen wrench inserted through a notch in one of the blades in each wheel.
3. **CAUTION:** To avoid potential vibration, allow slight air gap (min. 1/32") between wheels.

GALVANIZED - 3 3/16" - 10" DIAMETER

Part No.	Max. RPM	Dia.	Width	Rotation	Bore	OEM Applications
02895766	4500	3 13/16"	1 1/32"	CW	1/4"	Draft Inducers
02895767	4500	3 13/16"	1 1/32"	CCW	1/4"	Draft Inducers
02895768	4500	3 13/16"	1 7/8"	CW	5/16"	Draft Inducers, Evcon
02895769	4500	3 13/16"	1 7/8"	CCW	5/16"	Draft Inducers
02895770	4500	3 13/16"	2 1/2"	CW	5/16"	Draft Inducers, Reznor
02895771	4500	3 13/16"	2 1/2"	CCW	5/16"	Draft Inducers, Reznor
02895772	4500	3 27/32"	1 1/4"	CW	1/4"	Carrier, Draft Inducers
02895773	4500	3 27/32"	1 1/4"	CCW	1/4"	Carrier, Draft Inducers
02895774	4500	4"	1 1/2"	CCW	5/16"	Lennox, Carrier
02895775	4500	4"	2 1/2"	CCW	1/4"	Carrier, Amana, Draft Inducers
02895776	4500	4 1/4"	2"	CCW	1/4"	Carrier, Draft Inducer
02895721	4500	4 1/4"	2 1/2"	CW	3/8"	
02895722	4500	4 1/4"	2 1/2"	CCW	3/8"	
02895777	4500	4 1/4"	2 15/16"	CCW	1/4"	Lennox, Carrier, Draft Inducers
02895725	3450	4 3/4"	2 1/16"	CW	1/2"	
02895726	3450	4 3/4"	2 1/16"	CCW	1/2"	
02895727	3450	4 3/4"	2 1/2"	CW	1/2"	
02895728	3450	4 3/4"	2 1/2"	CCW	1/2"	
02895729	3450	4 3/4"	2 15/16"	CW	1/2"	
02895730	3450	4 3/4"	2 15/16"	CCW	1/2"	
02895731	3450	4 3/4"	3 7/16"	CW	1/2"	
02895732	3450	4 3/4"	3 7/16"	CCW	1/2"	
02895733	3450	5 1/4"	2 1/16"	CW	1/2"	
02895734	3450	5 1/4"	2 1/16"	CCW	1/2"	
02895735	3450	5 1/4"	2 1/2"	CW	1/2"	Carrier
02895736	3450	5 1/4"	2 1/2"	CCW	1/2"	Carrier
02895737	3450	5 1/4"	2 15/16"	CW	1/2"	
02895738	3450	5 1/4"	2 15/16"	CCW	1/2"	
02895739	3450	5 1/4"	3 7/16"	CW	1/2"	
02895740	3450	5 1/4"	3 7/16"	CCW	1/2"	
02895778	3450	5 5/8"	1 9/16"	CCW	15/16"	Carrier, Draft Inducers
02895753	3450	5 3/4"	2 1/16"	CW	1/2"	
02895754	3450	5 3/4"	2 1/16"	CCW	1/2"	
02895755	3450	5 3/4"	2 1/2"	CW	1/2"	
02895756	3450	5 3/4"	2 1/2"	CCW	1/2"	
02895757	3450	5 3/4"	2 15/16"	CW	1/2"	
02895758	3450	5 3/4"	2 15/16"	CCW	1/2"	
02895759	3450	5 3/4"	3 7/16"	CW	1/2"	Friedrich
02895760	3450	5 3/4"	3 7/16"	CCW	1/2"	
02895761	3450	5 3/4"	3 13/16"	CW	1/2"	
02895762	3450	5 3/4"	3 13/16"	CCW	1/2"	
02895779	3450	5 3/4"	4"	CW	1/2"	
02895780	3450	5 3/4"	4"	CCW	1/2"	
02895781	3450	6 1/4"	4"	CW	1/2"	
02895782	3450	6 1/4"	4"	CCW	1/2"	

Specifications are subject to change without notice or obligation.

BLOWER WHEELS

GALVANIZED - 3 3/16" - 10" DIAMETER - CONTINUED

Part No.	Max. RPM	Dia.	Width	Rotation	Bore	OEM Applications
02895741	3450	6 5/16"	2 1/16"	CW	1/2"	
02895742	3450	6 5/16"	2 1/16"	CCW	1/2"	
02895743	3450	6 5/16"	2 1/2"	CW	1/2"	
02895744	3450	6 5/16"	2 1/2"	CCW	1/2"	
02895745	3450	6 5/16"	2 15/16"	CW	1/2"	
02895746	3450	6 5/16"	2 15/16"	CCW	1/2"	
02895747	3450	6 5/16"	3 7/16"	CW	1/2"	
02895748	3450	6 5/16"	3 7/16"	CCW	1/2"	
02895749	3450	6 5/16"	3 13/16"	CW	1/2"	
02895750	3450	6 5/16"	3 13/16"	CCW	1/2"	
02895751	3450	6 1/4"	4 1/4"	CW	1/2"	
02895752	3450	6 1/4"	4 1/4"	CCW	1/2"	
02049153	2500	7 3/32"	3 5/32"	CW	1/2"	
02049154	2500	7 3/32"	3 5/32"	CCW	1/2"	
02049155	2500	7 3/32"	4"	CW	1/2"	Carrier
02049156	2500	7 3/32"	4"	CCW	1/2"	Carrier
02049157	2500	7 1/2"	2"	CW	1/2"	
02049158	2500	7 1/2"	2"	CCW	1/2"	
02049115	2500	7 7/16"	2 1/4"	CW	1/2"	
02049142	2500	7 7/16"	2 1/4"	CCW	1/2"	
02049159	2500	7 1/2"	2 1/2"	CW	1/2"	
02049160	2500	7 1/2"	2 1/2"	CCW	1/2"	
02049161	2000	7 1/2"	2 3/4"	CW	1/2"	
02049162	2000	7 1/2"	2 3/4"	CCW	1/2"	
02049163	1800	7 1/2"	3 5/32"	CW	1/2"	
02049164	1800	7 1/2"	3 5/32"	CCW	1/2"	
02049124	1650	7 7/16"	2 3/4"	CW	1/2"	
02049125	1650	7 7/16"	2 3/4"	CCW	1/2"	
02049137	1650	7 7/16"	3 1/4"	CW	1/2"	
02049120	1650	7 7/16"	3 1/4"	CCW	1/2"	
02049165	1650	7 1/2"	4"	CW	1/2"	Carrier
02049166	1650	7 1/2"	4"	CCW	1/2"	Carrier
02048763	1650	8"	3 3/16"	CW	1/2"	
02048764	1650	8"	3 3/16"	CCW	1/2"	
02048765	1650	8"	4"	CW	1/2"	
02048766	1650	8"	4"	CCW	1/2"	
02048767	1650	8 1/2"	3 3/16"	CW	1/2"	
02048768	1650	8 1/2"	3 3/16"	CCW	1/2"	
02048705	1650	8 1/2"	3 3/4"	CW	1/2"	
02048706	1650	8 1/2"	3 3/4"	CCW	1/2"	
02048769	1650	8 1/2"	4"	CW	1/2"	
02048770	1650	8 1/2"	4"	CCW	1/2"	
02048771	1400	8 1/2"	4 1/4"	CW	1/2"	
02048772	1750	8 1/2"	4 1/4"	CCW	1/2"	
02048738	1750	8 1/2"	4 1/4"	CW	1/2"	
02048739	1750	8 1/2"	4 1/4"	CCW	1/2"	
02055338	1750	9"	5"	CW	1/2"	
02055339	1750	9"	5"	CCW	1/2"	
02055301	1750	9 1/8"	3 3/4"	CW	1/2"	
02055303	1750	9 1/8"	3 3/4"	CCW	1/2"	
02055302	1750	9 1/8"	4 1/4"	CW	1/2"	Carrier
02055304	1750	9 1/8"	4 1/4"	CCW	1/2"	Carrier
01351110	1750	9 15/16"	6"	CCW	5/8"	Fedders
02055340	1750	10"	4"	CW	1/2"	Thermadore
02055341	1750	10"	4"	CCW	1/2"	

Maximum Operating Temperature - 200°F.

SINGLE INLET BLOWER WHEELS



STEEL SHAFT ADAPTER BUSHINGS* Zinc Finish

For use with single inlet wheels.



Part No.	Diameter		Length
	O.D.	I.D.	
029421-01	5/16"	1/4"	1"
029421-02	3/8"	1/4"	1 1/16"
029421-03	3/8"	5/16"	1 1/16"
029421-04	1/2"	5/16"	1 1/16"
029421-05	1/2"	3/8"	1 1/16"
029421-06	5/8"	1/2"	1 15/16"
029421-07	3/4"	5/8"	1 1/4"

* Must be ordered in multiples of 6.

TECHNICAL TIP:

Shaft adapters shown are used when a smaller bore diameter is required but not readily available. Use only one bushing for each hub.



BLOWER WHEELS

SINGLE INLET BLOWER WHEELS



- Steel hub clamps
- Molded from high strength polymer material
- Superior acoustic characteristics
- **Maximum Operating Temperature - 150°F**

PLASTIC - 5 3/8" - 8 3/8" DIAMETER

MANUFACTURED FOR MANY OEMS AS NOTED BELOW:

Part No.	Max. RPM	Dia.	Width	Rotation	Bore	OEM Applications
05379415	3450	5 3/8"	2 1/2"	CCW	1/2"	Frigidaire
05379401	3450	5 3/4"	2 1/2"	CCW	5/16"	Humidifiers Sears, Lau, etc.
05379402	3450	6 1/8"	3 7/8"	CW	1/2"	Carrier, GE, Trane
05379403	3450	6 1/8"	3 7/8"	CCW	1/2"	Carrier, GE, Trane
05379404	3450	6 7/8"	2 13/16"	CW	1/2"	Amana, Friedrich, Goodman
05379405	3450	6 7/8"	2 13/16"	CCW	1/2"	Amana, Friedrich, Goodman
05379406	2500	7 7/16"	3 9/16"	CW	1/2"	Friedrich
05379407	2500	7 7/16"	3 9/16"	CCW	1/2"	Friedrich
05379408	2500	7 1/2"	2 29/32"	CW	1/2"	Cold Point, Frigidaire
05379409	2000	7 5/8"	3 21/32"	CW	1/2"	Frigidaire, ICP
05379410	1800	7 25/32"	3 7/8"	CCW	1/2"	Amana
05379411	1650	8 1/16"	3 5/32"	CW	1/2"	Frigidaire, Friedrich
05379412	1650	8 3/8"	3 5/32"	CW	1/2"	Amana, Cold Point, Frigidaire
05379413	1650	8 3/8"	3 5/32"	CCW	1/2"	Amana, Cold Point, Frigidaire
05379414	1650	8 3/8"	3 5/8"	CW	1/2"	Amana, Cold Point, Frigidaire

GALVANIZED SINGLE INLET FOR LAU FGP & BD SERIES BLOWERS

- All steel galvanized construction
- Forward curved fan blades for quiet, efficient performance
- All wheels are dynamically balanced
- 10" - 18" diameter wheels are spun assembled construction
- 22" - 30" diameter wheels are precision-riveted construction
- **Maximum Operating Temperature - 200°F**

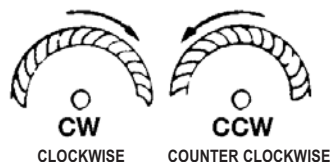

Rotation determined by viewing closed end of wheel (backplate).

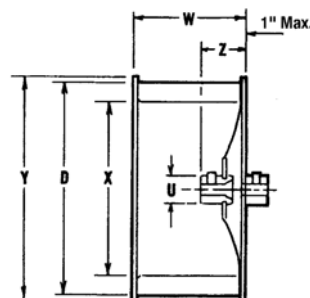

Part No.	Wheel Model	Bore Size	Rot.	Max. Wheel Cage RPM	Y	W	D	X	U	Z	No. Hubs	Hub Loc.	No. Setscrews Per Hub	Key Way
012398-57	SI 10-6A	3/4"	CW	1650	11 1/8	6	10 5/8	8 7/8	1 3/4	2 29/32	1	In	2	None
012398-58	SI 10-6A	3/4"	CCW	1650	11 1/8	6	10 5/8	8 7/8	1 3/4	2 29/32	1	In	2	None
014747-08	SI 12-6A	3/4"	CW	1350	13 3/16	6	12 5/8	10 5/16	1 3/4	2 29/32	1	In	2	None
014747-09	SI 12-6A	3/4"	CCW	1350	13 3/16	6	12 5/8	10 5/16	1 3/4	2 29/32	1	In	2	None
014528-01	SI 15-6A	1"	CW	1200	15 1/2	6	15	12 5/8	1 3/4	3 7/32	1	In	2	None
014528-03	SI 15-6A	1"	CCW	1200	15 1/2	6	15	12 5/8	1 3/4	3 7/32	1	In	2	None
020740-01	SI 15-9A	1"	CW	1050	15 1/2	9 1/2	15	12 5/8	1 3/4	3 7/32	2	In-Out	2-0	None
020740-04	SI 15-9A	1"	CCW	1050	15 1/2	9 1/2	15	12 5/8	1 3/4	3 7/32	2	In-Out	2-0	None
020202-03	SI 18-9A	1"	CW	1050	18 5/8	9	18 1/8	14 11/16	2 3/4	2 25/32	2	In-Out	1-0	1/4 x 1/8
020202-04	SI 18-9A	1"	CCW	1050	18 5/8	9	18 1/8	14 11/16	2 3/4	2 25/32	2	In-Out	1-0	1/4 x 1/8
026186-01	SI 18-13A	1"	CW	960	18 5/8	13 1/2	18 1/8	14 11/16	2 3/4	3 5/16	2	In-Out	1-1	1/4 x 1/8
026186-02	SI 18-13A	1"	CCW	960	18 5/8	13 1/2	18 1/8	14 11/16	2 3/4	3 5/16	2	In-Out	1-1	1/4 x 1/8
019965-03+A	SI 22-11K	1 3/16"	CW	900	23 1/4	11 1/4	22	17 7/8	2 3/4	3 1/2	2	In-Out	2-1	1/4 x 1/8
019965-06+A	SI 22-11K	1 3/16"	CCW	900	23 1/4	11 1/4	22	17 7/8	2 3/4	3 1/2	2	In-Out	2-1	1/4 x 1/8
019966-05*+	SI 25-12K	1 3/16"	CW	750	26 1/4	12 3/4	25	20 7/8	2 3/4	3 1/2	2	In-Out	2-1	1/4 x 1/8
019966-04*+	SI 25-12K	1 3/16"	CCW	750	26 1/4	12 3/4	25	20 7/8	2 3/4	3 1/2	2	In-Out	2-1	1/4 x 1/8
021071-03*+	SI 271/2-14K	1 7/16"	CW	700	28 3/4	13 15/16	27 1/2	23 3/8	2 3/4	3 1/2	2	In-Out	2-1	1/4 x 1/8
021071-04*+	SI 271/2-14K	1 7/16"	CCW	700	28 3/4	13 15/16	27 1/2	23 3/8	2 3/4	3 1/2	2	In-Out	2-1	1/4 x 1/8
021072-03*+	SI 30-15K	1 7/16"	CW	625	31 1/4	15 3/16	30	25 7/8	2 3/4	4 1/8	2	In-Out	2-1	1/4 x 1/8
021072-04*+	SI 30-15K	1 7/16"	CCW	625	31 1/4	15 3/16	30	25 7/8	2 3/4	4 1/8	2	In-Out	2-1	1/4 x 1/8

* Braced * Must ship via common carrier. ^ Special Order Only - allow 6 to 8 weeks lead time.

FRACTIONAL HP V-BELTS

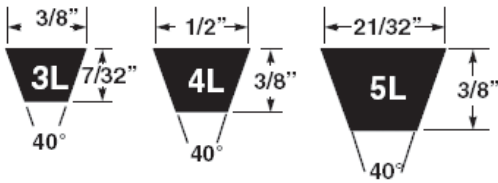

TOTALINE FHP V-Belts are built for maximum tension control, drive uniformity and long life, with minimum heat build-up and stretching on low horsepower electric motors and gasoline engines. They are designed for high speed operation and drive center distances as short as pulleys will allow.

3L Sizes

4L Sizes

5L Sizes

Part No.	Outside Length (in)
P465-3L150	15"
P465-3L160	16"
P465-3L170	17"
P465-3L180	18"
P465-3L190	19"
P465-3L200	20"
P465-3L210	21"
P465-3L220	22"
P465-3L230	23"
P465-3L240	24"
P465-3L250	25"
P465-3L260	26"
P465-3L270	27"
P465-3L280	28"
P465-3L290	29"
P465-3L300	30"
P465-3L310	31"
P465-3L320	32"
P465-3L330	33"
P465-3L340	34"
P465-3L350	35"
P465-3L360	36"
P465-3L370	37"
P465-3L380	38"
P465-3L390	39"
P465-3L400	40"
P465-3L410	41"
P465-3L420	42"
P465-3L430	43"
P465-3L440	44"
P465-3L450	45"
P465-3L460	46"
P465-3L470	47"
P465-3L480	48"
P465-3L490	49"
P465-3L500	50"
P465-3L510	51"
P465-3L520	52"
P465-3L530	53"
P465-3L540	54"
P465-3L550	55"
P465-3L560	56"
P465-3L570	57"
P465-3L580	58"
P465-3L590	59"
P465-3L600	60"
P465-3L610	61"
P465-3L620	62"
P465-3L630	63"

Part No.	Outside Length (in)
P465-4L160	16"
P465-4L170	17"
P465-4L180	18"
P465-4L190	19"
P465-4L200	20"
P465-4L210	21"
P465-4L220	22"
P465-4L230	23"
P465-4L240	24"
P465-4L250	25"
P465-4L260	26"
P465-4L270	27"
P465-4L280	28"
P465-4L290	29"
P465-4L300	30"
P465-4L310	31"
P465-4L320	32"
P465-4L330	33"
P465-4L340	34"
P465-4L350	35"
P465-4L360	36"
P465-4L370	37"
P465-4L380	38"
P465-4L390	39"
P465-4L400	40"
P465-4L410	41"
P465-4L420	42"
P465-4L430	43"
P465-4L440	44"
P465-4L450	45"
P465-4L460	46"
P465-4L470	47"
P465-4L480	48"
P465-4L490	49"
P465-4L500	50"
P465-4L510	51"
P465-4L520	52"
P465-4L530	53"
P465-4L540	54"
P465-4L550	55"
P465-4L560	56"
P465-4L570	57"
P465-4L580	58"
P465-4L590	59"
P465-4L600	60"
P465-4L610	61"
P465-4L620	62"
P465-4L630	63"
P465-4L640	64"

Part No.	Outside Length (in)
P465-4L650	65"
P465-4L660	66"
P465-4L670	67"
P465-4L680	68"
P465-4L690	69"
P465-4L700	70"
P465-4L710	71"
P465-4L720	72"
P465-4L730	73"
P465-4L740	74"
P465-4L750	75"
P465-4L760	76"
P465-4L770	77"
P465-4L780	78"
P465-4L790	79"
P465-4L800	80"
P465-4L810	81"
P465-4L820	82"
P465-4L830	83"
P465-4L840	84"
P465-4L850	85"
P465-4L860*	86"
P465-4L870*	87"
P465-4L880*	88"
P465-4L890*	89"
P465-4L900*	90"
P465-4L910*	91"
P465-4L920*	92"
P465-4L930*	93"
P465-4L940*	94"
P465-4L950*	95"
P465-4L960*	96"
P465-4L970*	97"
P465-4L980*	98"
P465-4L990*	99"
P465-4L1000*	100"
P465-5L230	23"
P465-5L240	24"
P465-5L250	25"
P465-5L260	26"
P465-5L270	27"
P465-5L280	28"
P465-5L290	29"
P465-5L300	30"
P465-5L310	31"
P465-5L320	32"
P465-5L330	33"
P465-5L340	34"
P465-5L350	35"

Part No.	Outside Length (in)
P465-5L360	36"
P465-5L370	37"
P465-5L380	38"
P465-5L390	39"
P465-5L400	40"
P465-5L410	41"
P465-5L420	42"
P465-5L430	43"
P465-5L440	44"
P465-5L450	45"
P465-5L460	46"
P465-5L470	47"
P465-5L480	48"
P465-5L490	49"
P465-5L500	50"
P465-5L510	51"
P465-5L520	52"
P465-5L530	53"
P465-5L540	54"
P465-5L550	55"
P465-5L560	56"
P465-5L570	57"
P465-5L580	58"
P465-5L590	59"
P465-5L600	60"
P465-5L610	61"
P465-5L620	62"
P465-5L630	63"
P465-5L640	64"
P465-5L650	65"
P465-5L660	66"
P465-5L670	67"
P465-5L680	68"
P465-5L690	69"
P465-5L700	70"
P465-5L710	71"
P465-5L720	72"
P465-5L730	73"
P465-5L740	74"
P465-5L750	75"
P465-5L760	76"
P465-5L770	77"
P465-5L780	78"
P465-5L790	79"
P465-5L800	80"
P465-5L810	81"
P465-5L820	82"
P465-5L830	83"
P465-5L840	84"

Part No.	Outside Length (in)
P465-5L850	85"
P465-5L860	86"
P465-5L870	87"
P465-5L880	88"
P465-5L890	89"
P465-5L900	90"
P465-5L910	91"
P465-5L920	92"
P465-5L930	93"
P465-5L940	94"
P465-5L950	95"
P465-5L960	96"
P465-5L970	97"
P465-5L980	98"
P465-5L990	99"
P465-5L1000	100"

*All belts are smooth



TOTALINE® FAN BELTS

MULTIPLE V-BELTS

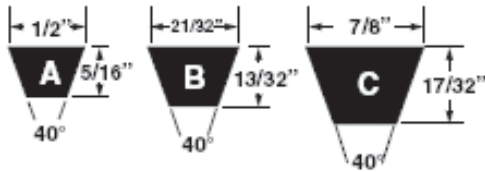

For multiple drive, high speed and high torque operation on light or heavy industrial or automotive machinery, TOTALINE Multiple V-Belts boast exceptional length, stability, and drive uniformity. Rigorous testing has shown these premium quality belts to have twice the service life or significantly greater transmission capacity than other multiple V-Belts.

A Sizes

Part No.	Outside Length (in)
P463-A20	22"
P463-A21	23"
P463-A22	24"
P463-A23	25"
P463-A24	26"
P463-A25	27"
P463-A26	28"
P463-A27	29"
P463-A28	30"
P463-A29	31"
P463-A30	32"
P463-A31	33"
P463-A32	34"
P463-A33	35"
P463-A34	36"
P463-A35	37"
P463-A36	38"
P463-A37	39"
P463-A38	40"
P463-A39	41"
P463-A40	42"
P463-A41	43"
P463-A42	44"
P463-A43	45"
P463-A44	46"
P463-A45	47"
P463-A46	48"
P463-A47	49"
P463-A48	50"
P463-A49	51"
P463-A50	52"
P463-A51	53"
P463-A52	54"
P463-A53	55"
P463-A54	56"
P463-A55	57"
P463-A56	58"
P463-A57	59"
P463-A58	60"
P463-A59	61"
P463-A60	62"
P463-A61	63"
P463-A62	64"
P463-A63	65"
P463-A64	66"
P463-A65	67"
P463-A66	68"
P463-A67	69"
P463-A68	70"
P463-A69	71"

Part No.	Outside Length (in)
P463-A70	72"
P463-A71	73"
P463-A72	74"
P463-A73	75"
P463-A74	76"
P463-A75	77"
P463-A76	78"
P463-A77	79"
P463-A78	80"
P463-A79	81"
P463-A80	82"
P463-A81	83"
P463-A82	84"
P463-A83	85"
P463-A84	86"
P463-A85	87"
P463-A86	88"
P463-A87	89"
P463-A88	90"
P463-A89	91"
P463-A90	92"
P463-A91	93"
P463-A92	94"
P463-A93	95"
P463-A94	96"
P463-A95	97"
P463-A96	98"
P463-A97	99"
P463-A98	100"
P463-A102	104"
P463-A105	107"
P463-A110	112"
P463-A116	118"
P463-A112	114"
P463-A120	122"
P463-A128	130"
P463-A136	138"
P463-A144	146"
P463-A158	160"
P463-A173	175"
P463-A180	182"
P463-AX20	22"
P463-AX22	24"
P463-AX23	25"
P463-AX25	27"
P463-AX26	28"
P463-AX27	29"
P463-AX28	30"
P463-AX29	31"
P463-AX30	32"

Part No.	Outside Length (in)
P463-AX31	33"
P463-AX32	34"
P463-AX33	35"
P463-AX34	36"
P463-AX35	37"
P463-AX36	38"
P463-AX37	39"
P463-AX38	40"
P463-AX39	41"
P463-AX40	42"
P463-AX41	43"
P463-AX42	44"
P463-AX43	45"
P463-AX44	46"
P463-AX45	47"
P463-AX46	48"
P463-AX47	49"
P463-AX48	50"
P463-AX49	51"
P463-AX50	52"
P463-AX51	53"
P463-AX52	54"
P463-AX53	55"
P463-AX54	56"
P463-AX55	57"
P463-AX58	58"
P463-AX60	62"
P463-AX62	64"
P463-AX63	65"
P463-AX64	66"
P463-AX66	68"
P463-AX67	69"
P463-AX70	72"
P463-AX71	73"
P463-AX78	80"
P463-AX80	82"
P463-AX90	92"
P463-AX112	114"

B Sizes

Part No.	Outside Length (in)
P463-B25	28"
P463-B26	29"
P463-B27	30"
P463-B28	31"
P463-B29	32"
P463-B30	33"
P463-B31	34"
P463-B32	35"
P463-B33	36"
P463-B34	37"
P463-B35	38"
P463-B36	39"
P463-B37	40"
P463-B38	41"
P463-B39	42"
P463-B40	43"
P463-B41	44"
P463-B42	45"
P463-B43	46"
P463-B44	47"
P463-B45	48"
P463-B46	49"
P463-B47	50"
P463-B48	51"
P463-B49	52"
P463-B50	53"
P463-B51	54"
P463-B52	55"
P463-B53	56"
P463-B54	57"
P463-B55	58"
P463-B56	59"
P463-B57	60"
P463-B58	61"
P463-B59	62"
P463-B60	63"
P463-B61	64"
P463-B62	65"
P463-B63	66"
P463-B64	67"
P463-B65	68"
P463-B66	69"
P463-B67	70"
P463-B68	71"
P463-B69	72"
P463-B70	73"
P463-B71	74"
P463-B72	75"
P463-B73	76"
P463-B74	77"

Part No.	Outside Length (in)
P463-B75	78"
P463-B76	79"
P463-B77	80"
P463-B78	81"
P463-B79	82"
P463-B80	83"
P463-B81	84"
P463-B82	85"
P463-B83	86"
P463-B84	87"
P463-B85	88"
P463-B86	89"
P463-B87	90"
P463-B88	91"
P463-B89	92"
P463-B90	93"
P463-B91	94"
P463-B92	95"
P463-B93	96"
P463-B94	97"
P463-B95	98"
P463-B96	99"
P463-B97	100"
P463-B100	103"
P463-B101	104"
P463-B103	105"
P463-B104	107"
P463-B105	108"
P463-B108	111"
P463-B111	114"
P463-B112	115"
P463-B115	118"
P463-B116	119"
P463-B120	123"
P463-B123	126"
P463-B124	127"
P463-B126	129"
P463-B129	132"
P463-B128	131"
P463-B133	136"
P463-B134	137"
P463-B136	139"
P463-B140	143"
P463-B142	145"
P463-B144	147"
P463-B148	151"
P463-B153	156"
P463-B154	157"
P463-B158	161"
P463-B162	165"

MULTIPLE V-BELTS - continued

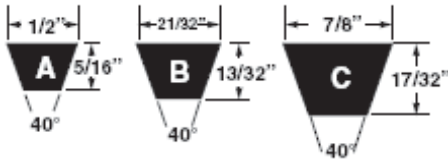

B Sizes - continued

Part No.	Outside Length (in)
P463-B173	176"
P463-B180	183"
P463-B195	198"
P463-B210	213"
P463-B225	228"
P463-B240	243"
P463-B255	258"
P463-B270	273"
P463-B285	288"
P463-B300	303"
P463-B315	318"
P463-BX27	30"
P463-BX28	31"
P463-BX29	32"
P463-BX30	33"
P463-BX31	34"
P463-BX32	35"
P463-BX34	37"
P463-BX35	38"
P463-BX37	40"
P463-BX38	41"
P463-BX39	42"
P463-BX40	43"
P463-BX41	44"
P463-BX42	45"
P463-BX43	46"
P463-BX44	47"
P463-BX45	48"
P463-BX46	49"
P463-BX47	50"
P463-BX48	51"
P463-BX49	52"
P463-BX50	53"
P463-BX51	54"
P463-BX52	55"
P463-BX53	56"
P463-BX54	57"
P463-BX55	58"
P463-BX56	59"
P463-BX57	60"
P463-BX58	61"
P463-BX59	62"
P463-BX60	63"
P463-BX61	64"
P463-BX62	65"
P463-BX63	66"
P463-BX64	67"
P463-BX65	68"
P463-BX66	69"
P463-BX67	70"

C Sizes

Part No.	Outside Length (in)
P463-BX68	71"
P463-BX69	72"
P463-BX71	74"
P463-BX72	75"
P463-BX73	76"
P463-BX75	78"
P463-BX76	79"
P463-BX77	80"
P463-BX78	81"
P463-BX80	83"
P463-BX81	84"
P463-BX82	85"
P463-BX83	86"
P463-BX85	88"
P463-BX86	89"
P463-BX88	91"
P463-BX90	93"
P463-BX93	96"
P463-BX95	98"
P463-BX97	100"
P463-BX99	102"
P463-BX100	103"
P463-BX103	106"
P463-BX105	108"
P463-BX106	109"
P463-BX108	111"
P463-BX112	115"
P463-BX116	119"
P463-BX124	127"
P463-BX126	129"
P463-BX128	131"
P463-BX133	136"
P463-BX136	139"
P463-BX144	147"
P463-C51	55"
P463-C60	64"
P463-C68	72"
P463-C75	79"
P463-C81	85"
P463-C85	89"
P463-C90	94"
P463-C96	100"
P463-C100	104"
P463-C105	109"
P463-C109	113"
P463-C112	116"
P463-C115	119"
P463-C120	124"
P463-C128	132"
P463-C136	140"
P463-C144	148"
P463-C150	154"
P463-C158	162"
P463-C162	166"
P463-C173	177"
P463-C180	184"
P463-C195	199"
P463-C210	214"
P463-C225	229"
P463-C240	244"
P463-C255	259"
P463-C270	274"
P463-C285	289"
P463-C300	304"
P463-C315	319"
P463-C330	334"
P463-C345	349"
P463-C360	364"
P463-C390	394"
P463-C420	424"
P463-C450	454"
P463-C480	484"
P463-CX162	166"



TOTALINE® FAN BELTS

NARROW V-BELTS - COGGED

The unique design and superior quality of the TOTALINE Narrow V-Belt allow you to build or redesign drive systems using smaller pulleys, with shorter center distances (reducing system weight and space) and increased horsepower capacity (exceeding RMA standards by 23.6% average). NOTE: The TOTALINE Narrow V-Belt in three section sizes is ideal for all applications covered by five section sizes of multiple V-belts. For multiple or single drives, the 3V replaces A, B, and C belts; the 5V replaces C and D belts; and the 8V replaces D and E belts.

3V Sizes

Part No.	Outside Length (in)
P464-3V215	22.63"
P464-3V250	25.63"
P464-3V265	27.63"
P464-3V280	28.63"
P464-3V300	30.63"
P464-3V315	32.63"
P464-3V335	34.63"
P464-3V355	36.63"
P464-3V375	38.63"
P464-3V400	40.63"
P464-3V425	43.13"
P464-3V450	45.63"
P464-3V475	48.13"
P464-3V500	50.63"
P464-3V530	53.63"
P464-3V560	56.63"
P464-3V600	60.63"
P464-3V630	63.63"
P464-3V670	67.63"
P464-3V710	71.63"
P464-3V750	75.63"
P464-3V800	80.63"
P464-3V850	85.63"
P464-3V900	90.63"
P464-3V950	95.63"
P464-3V1000	100.63"
P464-3V1060	106.63"
P464-3V1120	112.63"
P464-3V1180	118.63"
P464-3V1250	125.63"
P464-3V1320	132.63"
P464-3V1400	140.63"
P464-3VX215	21.5"
P464-3VX250	25"
P464-3VX265	26.5"
P464-3VX280	28"
P464-3VX300	30"
P464-3VX315	31.5"
P464-3VX335	33.5"
P464-3VX355	35.5"
P464-3VX375	37.5"
P464-3VX400	40"
P464-3VX425	42.5"
P464-3VX450	45"
P464-3VX475	47.5"
P464-3VX500	50"
P464-3VX530	53"
P464-3VX560	56"
P464-3VX600	60"
P464-3VX630	63"

Part No.	Outside Length (in)
P464-3VX670	67
P464-3VX710	71
P464-3VX750	75
P464-3VX800	80
P464-3VX850	85
P464-3VX900	90
P464-3VX950	95
P464-3VX1000	100
P464-3VX1060	106
P464-3VX1120	112
P464-3VX1150	118
P464-3VX1180	118.35
P464-3VX1250	125
P464-3VX1320	132
P464-3VX1400	140

5V Sizes

Part No.	Outside Length (in)
P464-5V500	50.75"
P464-5V530	53.75"
P464-5V560	56.75"
P464-5V600	60.75"
P464-5V630	63.75"
P464-5V670	67.75"
P464-5V710	71.75"
P464-5V750	75.75"
P464-5V800	80.75"
P464-5V850	85.75"
P464-5V900	90.75"
P464-5V950	95.75"
P464-5V1000	100.75"
P464-5V1060	106.75"
P464-5V1120	112.75"
P464-5V1180	118.75"
P464-5V1250	125.75"
P464-5V1320	132.75"
P464-5V1400	140.75"
P464-5V1500	150.75"
P464-5V1600	160.75"
P464-5V1700	170.75"
P464-5V1800	180.75"
P464-5V1900	190.75"
P464-5V2000	200.75"
P464-5V2120	212"
P464-5V2240	224"
P464-5V2360	236"
P464-5V2500	250"
P464-5V2650	265"
P464-5V2800	280"
P464-5V3000	300"
P464-5V3150	315"
P464-5V3350	335"
P464-5V3550	355"
P464-5VX450	45"
P464-5VX470	47"
P464-5VX490	49"
P464-5VX500	50"
P464-5VX510	51"
P464-5VX530	53"
P464-5VX540	54"
P464-5VX550	55"
P464-5VX560	56"
P464-5VX570	57"
P464-5VX580	58"
P464-5VX590	59"
P464-5VX600	60"
P464-5VX610	61"
P464-5VX630	63"

Part No.	Outside Length (in)
P464-5VX650	65"
P464-5VX660	66"
P464-5VX670	67"
P464-5VX680	68"
P464-5VX690	69"
P464-5VX710	71"
P464-5VX730	73"
P464-5VX740	74"
P464-5VX750	75"
P464-5VX780	78"
P464-5VX800	80"
P464-5VX830	83"
P464-5VX840	84"
P464-5VX850	85"
P464-5VX860	86"
P464-5VX880	88"
P464-5VX900	90"
P464-5VX930	93"
P464-5VX950	95"
P464-5VX960	96"
P464-5VX1000	100"
P464-5VX1030	103"
P464-51X1060	106"
P464-5VX1080	108"
P464-5VX1120	112"
P464-5VX1150	115"
P464-5VX1180	118"
P464-5VX1230	123"
P464-5VX1250	125"
P464-5VX1320	132"
P464-5VX1400	140"
P464-5VX1500	150"
P464-5VX1600	160"
P464-5VX1700	170"
P464-5VX1800	180"
P464-5VX1900	190"
P464-5VX2000	200"
P464-BX64	65.8"

AC CAPACITORS FOR MOTOR RUN APPLICATIONS



This capacitor series is designed specifically for the motor run applications where the capacitors are used in conjunction with permanent split capacitor type motors. They may be used on either 50 or 60-Hertz systems but should not be used at higher frequencies or in applications where higher frequency harmonics are present. For those types of applications the General Purpose AC Capacitors should be used.

FEATURES AND BENEFITS

- Reliability tested to meet 60,000 service hours, per United Technologies application parameters
- High grade metallized Polypropylene Film (5 to 12 microns thick)
- RoHS Compliant
- UL Approved with Pressure Sensitive interrupter of 1000 AFC
- Performance tested per United Technologies reliability requirements for capacitance ratings, power factor, dissipation factor and high voltage testing

PRODUCT RANGE

- Capacitance: 5uF to 80uF
- Tolerance: +/- 6%
- Voltage: 370 to 440 VAC
- Op Temp: -29° to +68° C

Note: Distributors that have historically stocked 440 volt and 370 volt capacitors round and / or oval designs can standardize inventory to use a 440 volt capacitors as replacement for a 370 volt capacitor provided the capacitance in (Mfd.) stays exactly the same.

Warning Note: Under no circumstances are we recommending usage of a 370 volt capacitor to replace a 440 volt capacitor. Also our capacitor straps are designed to secure and ground the capacitor, so we don't recommend mixing oval or round capacitor designs.



OVAL MOTOR RUN CAPACITOR - DUAL

Cap Grp	RCD P/N	Voltage (VAC)	Capacitance (µF) MFD	Dia	Height
Oval Dual	P291-0553	370	5/5	1.8	2.6
Oval Dual	P291-0773	370	7.5/7.5	1.8	3.1
Oval Dual	P291-1013	370	10/10	1.8	3.3
Oval Dual	P291-1513	370	15/10	1.8	3.3
Oval Dual	P291-1543	370	15/4	1.8	3.1
Oval Dual	P291-1553	370	15/5	1.8	3.1
Oval Dual	P291-1554	440	15/5	1.8	3.1
Oval Dual	P291-1573	370	15/7.5	1.8	3.3
Oval Dual	P291-2053	370	20/5	1.8	3.3
Oval Dual	P291-2054	440	20/5	1.8	3.5
Oval Dual	P291-2074	440	20/7.5	1.8	3.9
Oval Dual	P291-2513	370	25/10	1.8	3.7
Oval Dual	P291-2543	370	25/4	1.8	3.5
Oval Dual	P291-2553	370	25/5	1.8	3.5
Oval Dual	P291-2554	440	25/5	1.8	3.9
Oval Dual	P291-2573	370	25/7.5	1.8	3.5
Oval Dual	P291-2574	440	25/7.5	1.9	3.7
Oval Dual	P291-3013	370	30/10	1.9	3.5
Oval Dual	P291-3014	440	30/10	1.9	4.1
Oval Dual	P291-3053	370	30/5	1.8	3.7
Oval Dual	P291-3054	440	30/5	1.9	4.1
Oval Dual	P291-3073	370	30/7.5	1.8	3.7
Oval Dual	P291-3074	440	30/7.5	1.9	4.1
Oval Dual	P291-3514	440	35/10	1.9	4.5
Oval Dual	P291-3523	370	35/12.5	1.9	3.7
Oval Dual	P291-3543	370	35/4	1.9	3.7
Oval Dual	P291-3553	370	35/5	1.9	3.7
Oval Dual	P291-3554	440	35/5	1.9	4.5
Oval Dual	P291-3554S	440	35/5	1.8	4.9
Oval Dual	P291-3573	370	35/7.5	1.9	3.7

Cap Grp	RCD P/N	Voltage (VAC)	Capacitance (µF) MFD	Dia	Height
Oval Dual	P291-3574	440	35/7.5	1.9	4.5
Oval Dual	P291-4014	440	40/10	1.9	4.7
Oval Dual	P291-4053	370	40/5	1.9	4.1
Oval Dual	P291-4053S	370	40/5	1.9	4.3
Oval Dual	P291-4054	440	40/5	1.9	4.5
Oval Dual	P291-4073	370	40/7.5	1.9	4.1
Oval Dual	P291-4074	440	40/7.5	1.9	4.7
Oval Dual	P291-4513	370	45/10	1.9	4.3
Oval Dual	P291-4553	370	45/5	1.9	4.3
Oval Dual	P291-4554	440	45/5	1.9	4.7
Oval Dual	P291-4554S	440	45/5	1.9	5.5
Oval Dual	P291-4573	370	45/7.5	1.9	4.3
Oval Dual	P291-4574	440	45/7.5	1.9	4.9
Oval Dual	P291-5014	440	50/10	1.9	5.1
Oval Dual	P291-5053	370	50/5	1.9	4.7
Oval Dual	P291-5054	440	50/5	1.9	4.9
Oval Dual	P291-5074	440	50/7.5	1.9	4.9
Oval Dual	P291-5513	370	55/10	1.9	5.3
Oval Dual	P291-5553	370	55/5	1.9	5.3
Oval Dual	P291-5554	440	55/5	1.9	5.3
Oval Dual	P291-5574	440	55/7.5	1.9	5.3
Oval Dual	P291-6013	370	60/10	1.9	5.5
Oval Dual	P291-6014	440	60/10	1.9	5.5
Oval Dual	P291-6053	370	60/5	1.9	5.3
Oval Dual	P291-7053	370	70/5	1.9	5.7
Oval Dual	P291-8013	370	80/10	1.9	6.3
Oval Dual	P291-8053	370	80/5	1.9	6.3
Oval Dual	P291-8054	440	80/5	1.9	6.3
Oval Dual	P291-8073	370	80/7.5	1.9	6.3

OVAL MOTOR RUN CAPACITOR - SINGLE

Cap Grp	RCD P/N	Voltage (VAC)	Capacitance (μF) MFD	Dia	Height
Oval Single	P291-0203	370	2	1.2	2.6
Oval Single	P291-0303	370	3	1.2	2.6
Oval Single	P291-0304	440	3	1.2	2.6
Oval Single	P291-0403	370	4	1.2	2.8
Oval Single	P291-0404	440	4	1.2	2.8
Oval Single	P291-0503	370	5	1.2	2.8
Oval Single	P291-0504	440	5	1.2	3.1
Oval Single	P291-0603	370	6	1.2	3.1
Oval Single	P291-0604	440	6	1.2	3.1
Oval Single	P291-0753	370	7.5	1.2	3.5
Oval Single	P291-0754	440	7.5	1.2	3.5
Oval Single	P291-1003	370	10	1.2	3.5
Oval Single	P291-1004	440	10	1.2	4.1
Oval Single	P291-1253	370	12.5	1.2	3.5
Oval Single	P291-1254	440	12.5	1.2	4.5
Oval Single	P291-1503	370	15	1.2	3.7
Oval Single	P291-1504	440	15	1.2	4.5
Oval Single	P291-1753	370	17.5	1.2	4.1
Oval Single	P291-1754	440	17.5	1.8	3.1
Oval Single	P291-2003	370	20	1.2	4.3
Oval Single	P291-2004	440	20	1.8	3.1
Oval Single	P291-2503	370	25	1.8	3.1
Oval Single	P291-2503S	370	25	1.2	4.9

Cap Grp	RCD P/N	Voltage (VAC)	Capacitance (μF) MFD	Dia	Height
Oval Single	P291-2504	440	25	1.8	3.5
Oval Single	P291-3003	370	30	1.8	3.3
Oval Single	P291-3003S	370	30	1.2	5.3
Oval Single	P291-3004	440	30	1.8	3.9
Oval Single	P291-3503	370	35	1.8	3.7
Oval Single	P291-3504	440	35	1.8	4.3
Oval Single	P291-4003	370	40	1.8	3.9
Oval Single	P291-4004	440	40	1.9	3.5
Oval Single	P291-4503	370	45	1.9	3.5
Oval Single	P291-4504	440	45	1.9	3.7
Oval Single	P291-5003	370	50	1.9	3.5
Oval Single	P291-5004	440	50	1.9	3.9
Oval Single	P291-5503	370	55	1.9	3.5
Oval Single	P291-5504	440	55	1.9	4.1
Oval Single	P291-6003	370	60	1.9	3.7
Oval Single	P291-6004	440	60	1.9	4.3
Oval Single	P291-6503	370	65	1.9	3.7
Oval Single	P291-6504	440	65	1.9	4.5
Oval Single	P291-7003	370	70	1.9	3.9
Oval Single	P291-7004	440	70	1.9	4.7
Oval Single	P291-8003	370	80	1.9	4.3
Oval Single	P291-8004	440	80	1.9	4.9



ROUND MOTOR RUN CAPACITOR - DUAL

Cap Grp	RCD P/N	Voltage (VAC)	Capacitance (µF) MFD	Dia	Height
Round Dual	P291-1553RS	370	15/5	2.0	3.5
Round Dual	P291-1554RS	440	15/5	2.0	4.3
Round Dual	P291-2053R	370	20/5	2.0	3.7
Round Dual	P291-2054RS	440	20/5	2.0	4.6
Round Dual	P291-2513R	370	25/10	2.5	4.3
Round Dual	P291-2534R	440	25/3	2.0	4.4
Round Dual	P291-2553RS	370	25/5	2.0	3.9
Round Dual	P291-2554R	440	25/5	2.5	4.3
Round Dual	P291-2554RS	440	25/5	2.0	4.8
Round Dual	P291-2573R	370	25/7.5	2.5	3.7
Round Dual	P291-2573RS	370	25/7.5	2.0	4.3
Round Dual	P291-3013RS	370	30/10	2.0	4.4
Round Dual	P291-3033R	370	30/3	2.0	4.1
Round Dual	P291-3053RS	370	30/5	2.0	4.1
Round Dual	P291-3054R	440	30/5	2.5	4.3
Round Dual	P291-3054RS	440	30/7.5	2.0	5.2
Round Dual	P291-3073R	370	30/7.5	2.5	3.7
Round Dual	P291-3073RS	370	35/10	2.0	4.4
Round Dual	P291-3513RS	370	35/3	2.0	4.8
Round Dual	P291-3533R	370	35/3	2.0	4.4
Round Dual	P291-3534R	440	35/5	2.5	4.3
Round Dual	P291-3553RS	370	35/5	2.0	4.4
Round Dual	P291-3554RS	440	35/7.5	2.0	5.2
Round Dual	P291-3573R	370	35/7.5	2.5	3.7
Round Dual	P291-3573RS	370	35/7.5	2.0	4.8
Round Dual	P291-3574RS	440	35/7.5	2.0	5.2
Round Dual	P291-4033R	370	40/3	2.0	4.6
Round Dual	P291-4034R	440	40/3	2.5	4.3
Round Dual	P291-4053RS	370	40/5	2.0	4.6
Round Dual	P291-4054RS	440	40/5	2.0	5.8
Round Dual	P291-4073RS	370	40/7.5	2.0	5.0

Cap Grp	RCD P/N	Voltage (VAC)	Capacitance (µF) MFD	Dia	Height
Round Dual	P291-4074RS	440	40/7.5	2.0	5.6
Round Dual	P291-4513RS	370	45/10	2.0	5.2
Round Dual	P291-4533R	370	45/3	2.0	4.8
Round Dual	P291-4553RS	370	45/5	2.0	4.8
Round Dual	P291-4554RS	440	45/5	2.5	4.4
Round Dual	P291-4573RS	370	45/7.5	2.0	5.2
Round Dual	P291-4574RS	440	45/7.5	2.5	4.8
Round Dual	P291-5053RS	370	50/5	2.0	5.2
Round Dual	P291-5054RS	440	50/5	2.5	4.8
Round Dual	P291-5073RS	370	50/7.5	2.0	5.4
Round Dual	P291-5513R	370	55/10	2.5	4.6
Round Dual	P291-5514RS	440	55/10	2.5	5.2
Round Dual	P291-5553RS	370	55/5	2.5	4.3
Round Dual	P291-5554RS	440	55/5	2.5	4.4
Round Dual	P291-5573RS	370	55/7.5	2.5	4.3
Round Dual	P291-5574RS	440	55/7.5	2.5	5.2
Round Dual	P291-6013R	370	60/10	2.5	4.8
Round Dual	P291-6053RS	370	60/5	2.5	4.6
Round Dual	P291-6054R	440	60/5	2.5	5.2
Round Dual	P291-6073RS	370	60/7.5	2.5	4.6
Round Dual	P291-6074R	440	60/7.5	2.5	5.2
Round Dual	P291-7013RS	370	70/10	2.5	5.2
Round Dual	P291-7053RS	370	70/5	2.5	4.8
Round Dual	P291-7054R	440	70/5	2.5	5.4
Round Dual	P291-7073RS	370	70/7.5	2.5	4.8
Round Dual	P291-7554R	440	75/5	2.5	5.6
Round Dual	P291-8013RS	370	80/10	2.5	5.4
Round Dual	P291-8053RS	370	80/5	2.5	5.2
Round Dual	P291-8054RS	440	80/5	2.5	5.8
Round Dual	P291-8073RS	370	80/7.5	2.5	5.2

ROUND MOTOR RUN CAPACITOR - SINGLE

Cap Grp	RCD P/N	Voltage (VAC)	Capacitance (µF) MFD	Dia	Height
Round Single	P291-0503R	370	5	1.8	2.9
Round Single	P291-0753R	370	7.5	1.8	2.9
Round Single	P291-1003R	370	10	1.8	2.9
Round Single	P291-1004R	440	10	1.8	2.9
Round Single	P291-1253R	370	12.5	1.8	2.9
Round Single	P291-1503R	370	15	1.8	3.3
Round Single	P291-1504R	440	15	1.8	3.3
Round Single	P291-2003R	370	20	1.8	3.5
Round Single	P291-2004R	440	20	1.8	3.5
Round Single	P291-2503R	370	25	1.8	3.5
Round Single	P291-2503RS	370	25	1.8	3.5
Round Single	P291-2504R	440	25	1.8	4.1
Round Single	P291-3003R	370	30	1.8	4.3

Cap Grp	RCD P/N	Voltage (VAC)	Capacitance (µF) MFD	Dia	Height
Round Single	P291-3004R	440	30	1.8	4.3
Round Single	P291-3504R	440	35	1.8	4.6
Round Single	P291-4003R	370	40	2.0	3.9
Round Single	P291-4004R	440	40	1.8	5.2
Round Single	P291-4503R	370	45	2.5	4.3
Round Single	P291-4504RS	440	45	2.0	4.8
Round Single	P291-5003R	370	50	2.5	4.3
Round Single	P291-5004R	440	50	2.5	4.3
Round Single	P291-5504R	440	55	2.5	4.4
Round Single	P291-6004R	440	60	2.5	4.4
Round Single	P291-6503R	370	65	2.5	4.3
Round Single	P291-8003R	370	80	2.5	5.2

PROPELLER ACCESSORIES

RAINSHIELDS



7"

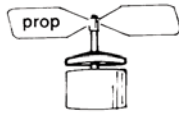

Interior cooling blades force air over motor. Use 7" diameter for open type motors.



3 1/2"

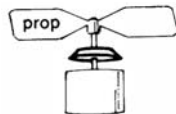

Position rainshield between propeller and motor. Use 3 1/2" diameter for closed motors.

An inexpensive way to reduce the potential of rain getting into the motor bearings on vertical shaft motor applications. Use primarily for vertical shaft motors on outdoor condensing units, but can also be used in any position to keep water from migrating along the shaft.

- Simple press fit on the 1/2" to 5/8" shafts
- 7" with interior cooling blades effectively reduces motor winding temperature and protects open motors
- 3 1/2" for closed motors to protect bearings
- Used as original equipment on many new air conditioners

Part No.	Single Size
60385303	3 1/2" x 1/2"
60379501	7" x 1/2"
60379502	7" x 5/8"

FINNED PLASTIC RAINSHIELD

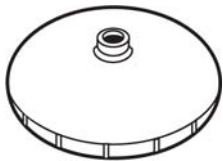

Finned plastic rainshield provides additional motor cooling by drawing air through motor. For use with vertically mounted condenser motors in shaft up position.

Outside Diameter: 7 1/2"

Part No.	Bore Size
P251-0056	1/2"
P251-0057	5/8"

PLASTIC SLINGER RAINSHIELD

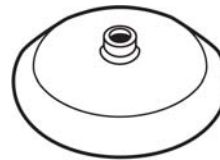

Plastic slinger for use with vertically mounted condenser motors in shaft up position.

Outside Diameter: 3 1/2"

Part No.	Bore Size
P251-0058	1/2"
P251-0059	5/8"

PLASTIC RAINSHIELD



Plastic rainshield for use with vertically mounted condenser motors in shaft up position.

Outside Diameter: 7 3/10"

Part No.	Bore Size
P251-0052	5/8"

METAL RAINSHIELD



Metal rainshield with rubber grommet to fit bearing hub protects motor windings only. Bearing slinger P251-0059 is also required for shaft bearing protection.

Aluminum rainshield for use with vertically mounted condenser motor in shaft up position.

Outside Diameter: 6 3/10"

Part No.	Bore Size
P251-0051	1/2"

Specifications are subject to change without notice or obligation.



PARTS & ACCESSORIES

HUB PULLERS



GENERAL DUTY APPLICATIONS

- Precision machined
- 5/8" steel bolt machined and tapered on one end
- 1 1/4" threading into body resists stripping
- Standard 7/8" wrench fitting
- Four grab bolts for maximum holding power
- Torque Limit: 75 ft. lbs



HEAVY DUTY APPLICATIONS

- Zinc plated, heavy steel construction
- Sight holes for visual alignment of puller and motor shaft
- Four square head cup point grab bolts
- 5/8" bolt will not bend with proper use
- Bar top – grip with wrench
- 1/4" steel collar
- 1" long threaded surface
- Torque Limit: 75 ft. lbs

HUB PULLERS / REPLACEMENT PARTS

Hub Puller	Replacement Fingers (set of 4)	Main Center Shaft	Centering Sleeve
05380401 - General Duty	05249901	05249701	05249801
05214101 - Heavy Duty	05221101	05221201	05221301

PITCH GAUGE



Part No.
05099801

EVERY TOOLBOX NEEDS A LAU PITCH GAUGE

Eliminate the guesswork when replacing old propellers. Lau's pitch gauge measures the correct pitch and direction of rotation.

FOLLOW THESE 3 STEPS TO MEASURE PROPELLER ROTATION AND PITCH:



STEP 1

Position the faceplate of the gauge on the blade of the fan

STEP 2

Place the foot of the wire body of the pitch gauge on the center section (spider) of the fan

STEP 3

The pointer gives a direct reading of the pitch in degrees, and the clockwise / counter-clockwise markings indicate the rotation

RUBBER FAN HUB CAP



Rubber fan hub cap prevents vertical mounted condenser fan from seizing to motor shaft.

Part No.
P251-0061

TECINSpect



- 16-Pin and 4-Pin Connector for diagnostics on Genteq Variable Speed Models
- Works with ECM models: 2.0, 2.3, Eon, 3.0, X13/Endura PRO
- Comes with ECM Service Guide

Part No.
GE-A447

Specifications are subject to change without notice or obligation.

TOTALINE® BRACKET KITS

MOTOR MOUNT KIT

Stamped steel motor mounting kits for 42 and 48 frame direct drive blower motors. Kits contain belly band, mounting arms, rubber isolation grommets and 1/4-20 sleeved bolts and nuts for attaching mount to fan housing.

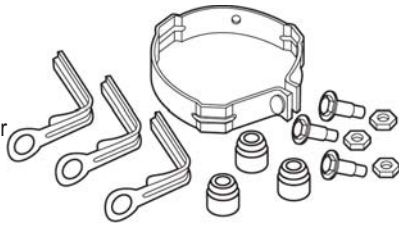

Part No.	Motor Diameter	Bolt Circle
P251-0074	5.3"	11.6"
P251-0075	5"	11"

ADJUSTABLE MOTOR MOUNT KIT

Use when replacing motors which originally had welded on mounting ears. Mounting ears have 5/16" slots and 3/4" knockouts which are adaptable to a wide range of mounting dimensions.

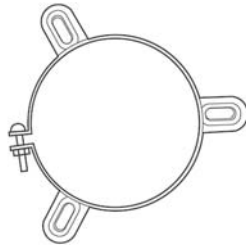

Part No.
P251-0015

TORSION FLEX BRACKET

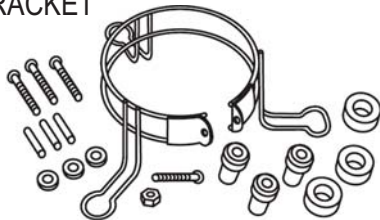

Part No.	Motor Frame	Bolt Circle	Emerson No.
P251-0010	42	9 9/32"	16
P251-0011	48	10"	17

TORSION FLEX BRACKET

An economical alternative to conventional mounts that require rubber grommets.

- Fits 9" or 10" blowers
- Maximum motor weight is 16 lbs
- Used with 5 1/2" diameter direct drive blower motors

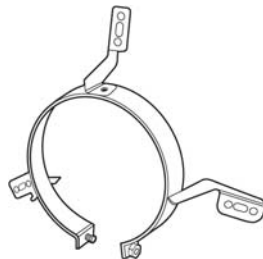

Part No.
P251-0073

DIRECT DRIVE MOTOR MOUNTING BRACKETS

FLEXIBLE MOUNT "BELLY" BAND ADAPTER

Adapts either to a 5" diameter motor (42-frame), or a 5 5/8" (48-frame) to mount on 9" and 10" blowers.



Part No.	Fits
05407401	5" Motor
05407402	5 5/8" Motor

MOTOR MOUNTING BRACKET

Supported from the housing venturi, mounting brackets are adjusted for motors 31/2" to 61/8" in length and accommodates a 48-frame motor. Adjusts to various wheel widths with the necessary hardware furnished.



Part No.	Blower Size
38251401	9"
38251501	10"
02612601	11"
02612601	12"

UNIVERSAL MOTOR MOUNTING BRACKETS

Lau's universal motor mounting brackets accommodate 10" and 12" blowers (includes mounting hardware).



Part No. 42-Frame Motors (5" Dia.)	Part No. 48-Frame Motors (5 5/8" Dia.)	Blower Size
02869101	02869201	10"
N/A	05409101	12"



PARTS & ACCESSORIES

BEARING BRACKETS FOR BELT DRIVE BLOWERS

NOTE - 18" version has 2 belt holes on each bracket leg.

One-Piece Bracket
(sold individually)



Part No.	Belt Drive Blower (1)	A	B	OD*
00896004	18"	9 5/16"	8 13/16"	2 1/2"
01443102	15"	7 13/16"	7 7/16"	2 1/2"
01573001	12"	6 5/16"	6"	2 1/2"

*OD as measured over rubber cushion.

KNOCK DOWN BRACKET KIT

For easier installation. Accommodates bearings that have 1 13/16" O.D.
(Fits up to 18 1/2" bolt circle.)

NOTE - When combined with a pair of 3/4" Lau bearings, can also replace obsolete flange bearing #38208201.



Part No. (Pair)	O.D. of Rubber Cushion
38269901	1 13/16"

SLEEVE BEARING BRACKET KIT

- Ideal for replacing obsolete pillow blocks and streamlined bearings
- Can also be used in some evaporative cooler applications
- Specially designed to fit most blowers from 9" to 16" sizes
- Sturdy, compact, 10-gauge steel bearing and bracket – completely assembled and ready to mount
- Sintered bronze ball assembly securely held in a spherical rubber isolating liner to assure maximum vibration absorption, quiet operation, constant self-alignment and long life
- Packaged in pairs with shaft and hardware group

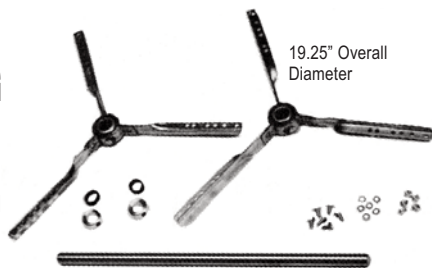

Part No.	Shaft Diameter	Maximum HP	Shaft Length
02917501*	3/4"	3/4 HP	20"
02917601	1"	1 HP	25"

*02917501 also replaces obsolete Part Number 38208201.

BEARINGS

LAU-PAK™ - SLEEVE SEALED TYPE BEARINGS WITH INSULATOR

Self-aligning, factory-packed with a supply of plastic petroleum assuring proper lubrication during the long life of the bearing. Self-aligning, porous bronze sleeve pressed in housing.



NOTE - Temperature Range for Sleeve Bearings: 40° - 135°.

Part No. (Pair)*	Shaft Diameter	O.D.*
38244301	5/8"	1 13/16"
38244302	3/4"	1 13/16"
38244303	1"	2 1/2"

*O.D. as measured over rubber cushion.

SEALED SLEEVE BEARINGS (REPLACES BRUNDAGE)

Self-aligning, factory-packed with a supply of plastic petroleum assuring proper lubrication during life of bearing.



NOTE - Temperature Range for Sleeve Bearings: 40° - 135°.

Part No. (Pair)*	Shaft Diameter	O.D.*
38269401	3/4"	2 1/16"
38269501	1"	2 1/16"

*O.D. as measured over rubber cushion.

SEALED TYPE BALL BEARINGS WITH INSULATOR

For use when operating conditions exceed the limits of sleeve bearings or where repetitive failures occur. These bearings are pre-lubricated at the factory and require no further lubrication or attention. They are equipped with seals for positive grease retention and protection against contaminants.



NOTE - Temperature Range for Sleeve Bearings: 40° - 135°.

Part No. (Pair)*	Temp. Range °F	Shaft Diameter w/ interlocking thrust collar	O.D.*
38258801	-20° +180°	3/4"	1 13/16"
38259001	-20° +180°	1"	2 17/32"
38256201	-20° +180°	1 3/16"	2 17/32"

*O.D. as measured over rubber cushion.

+ Bearings shipped in pairs

Specifications are subject to change without notice or obligation.

BEARINGS

LAU OIL TYPE - SLEEVE BEARINGS WITH INSULATOR

Self-aligning, self-oiling, with bronze bushing held in housing under light, uniform spring pressure, providing uniform distribution of lubricant through pores of bushing. Drive type oil cup.



NOTE - Shipped dry. Lubricate at time of installation with SAE 20 or 30 weight oil.

Part No. (Pair)*	Shaft Diameter	O.D.*
38240401	5/8"	1 13/16"
38244201	3/4"	1 13/16"
38244202	1"	2 1/2"

*O.D. as measured over rubber cushion.

OIL SLEEVE BEARINGS (REPLACES BRUNDAGE)

Self-oiling with sintered bronze bushings and drive type oil cups.



Part No. (Pair)*	Shaft Diameter	O.D.*
38269601	3/4"	2 1/16"
38269701	1"	2 1/16"

*O.D. as measured over rubber cushion.

OIL TYPE - SLEEVE BEARINGS WITH INSULATOR

Self-aligning, self-oiling with sintered bronze bushings and drive type oil cups.



NOTE - Re-lubricate with SAE 20 or 30 weight oil. (Due to wicking, may need to oil at time of installation.)

Part No. (Pair)*	Shaft Diameter	O.D.*
38245001	3/4"	1 27/32"
38244901	1"	1 27/32"
38209401	1" Heavy Duty	2 1/2"

*O.D. as measured over rubber cushion.

TOTALINE® BRONZE BEARING

- Porous bronze sleeve
- Oil cup



Part No.	Outside Diameter	Bore Diameter	Width
P461-2301*	1 11/16"	3/4"	1 1/4"

*Requires Isolator P461-2001.

BEARINGS

CARTRIDGE TYPE SLEEVE BEARINGS

This cartridge type bearing has been designed to give you fast, easy interchangeability. It will fit any "spider type" bracket used on 9", 10", and 12" blowers.

Sintered bronze bushing pressed into steel bearing caps and cushioned in heavy neoprene conductive rubber. Factory-packed with lubricant for many years of quiet, trouble-free service. The cartridge bearing with a journal may permit use of old shaft.



Cartridge Bearing with Journal



Types of "Spider" Brackets

Part No. (Pair)*	Shaft Diameter	O.D.*
38209101 Mark IV	3/4" w/ thrust & spacer	1 13/16"
38227201 Mark III	3/4" w/ journal	1 13/16"
38209001	1"	1 13/16"

*O.D. as measured over rubber cushion.

BALL BEARING CARTRIDGE UNITS



- Light duty series
- Molded rubber outer liner
- Eccentric self-locking collar

- Permanently lubricated
- Quiet operation
- Width: 1"



Part No.	Outside Diameter	Bore Diameter
P461-2202	2.5"	1/2"
P461-2502	2.5"	5/8"
P461-2302	1.8"	3/4"
P461-2304	2.5"	3/4"
P461-2201	1.7"	1/2"
P461-2102	2.5"	1"
P461-2103*	2.5"	1"
P461-2901	2.5"	1 3/16"

*Width 3/4 inch.

BALL BEARING CARTRIDGE UNITS



- Porous bronze sleeve
- Sealed type
- Self-aligning



Part No.	Outside Diameter	Bore Diameter	Width
P461-2303	1 13/16"	3/4"	1"
P461-2101	2 1/2"	1"	1 3/8"

+ Bearings shipped in pairs



BEARINGS

PILLOW BLOCK SLEEVE BEARINGS

Heavy neoprene cushioned, re-oilable porous bronze bushing in a pressed steel ball unit held firmly in a housing of two-piece interlocking steel.

This high quality self-aligning, static-free, pillow block will assure quiet operation and many years of trouble-free performance. Two 1/8" rubber spacers provided for use, if needed.

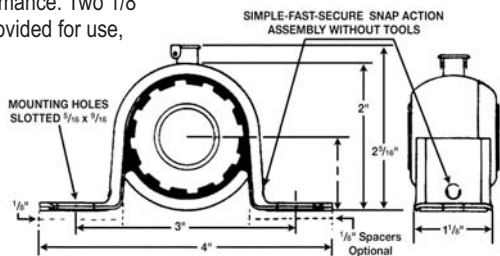

For use on horizontal shaft applications only

Part No. (Pair)*	Shaft Diameter
38220401	5/8"
38208601	3/4"
38208701	1"
38209301*	1" Heavy Duty

*Dimensions for the heavy duty pillow block are: mounting holes on center 3 1/2"; base to shaft center 1 3/16"; width 1 1/2".

PILLOW BLOCK BALL BEARINGS

- Durable cast-iron construction
- Pre-lubricated bearings
- Re-greaseable

NOTE - Temperature Range: -30 to 200°F.



Part No. (Pair)*	Shaft Diameter	Spread		Hole Size	O.D.*
		Min.	Max.		
38256701	3/4"	3 5/8"	3 7/8"	9/16" x 13/32"	3 5/16"
38256801	1"	3 7/8"	4 1/8"	9/16" x 13/32"	1 7/16"
38256901	1 3/16"	4 1/2"	4 3/4"	3/4" x 9/16"	1 11/16"
38257001	1 7/16"	4 3/5"	5"	3/4" x 9/16"	1 7/8"

*O.D. as measured over rubber cushion.

TECHNICAL TIP:

Pillow block ball bearings are pre-lubricated at the factory. Normal operating temperature is from -30°F to 200°F. Under normal operating conditions (clean environment and RPM under 1500) re-lubrication is recommended at 6-12 month intervals. When re-greasing, care should be taken not to over grease as seal blow out and/or bearing burnout can occur.

BEARINGS

PILLOW BLOCK LIGHT DUTY SERIES



- Permanently lubricated
- Rubber cushion interliner
- Eccentric locking collar
- Two-piece pressed steel housing
- Self-aligning



Part No.	Base to Shaft Center	Mounting Center Distance	Bore Diameter	Type
P461-2203	9/16"	2"	1/2"	SLV
P461-2503	.70"	3"	5/8"	SLV
P461-2501	1"	3"	5/8"	BALL
P461-2306	1 1/8"	3 3/8"	3/4"	BALL
P461-2104	1 5/16"	3 3/4"	1"	BALL
P461-2904	1 5/16"	3 3/4"	1 3/16"	BALL

PILLOW BLOCK BRONZE BEARING



- Porous bronze sleeve
- Self-aligning
- Spherical bearing cartridge
- Quiet operation
- Oil cup for re-lubrication



Part No.	Base to Shaft Center	Mounting Center Distance	Bore Diameter
P461-2504	1"	3 1/8"	5/8"
P461-2305*	1"	3 1/8"	3/4"
P461-2106	1"	4 1/16"	1"
P461-2107	1 3/8"	3 5/16"	1"

FLANGE BALL BEARINGS

Permanently sealed and lubricated, two-bolt flange unit, rubber-mounted oil-resistant, rubber isolator. Stamped steel housing.



Part No. (Pair)*	Shaft Diameter	Spread	Hole Size	O.D.*
38256501	3/4"	3 5/8"	7/16"	2 41/64"
38256502	1"	3 5/8"	7/16"	2 41/64"
38256601	1 3/16"	4 5/8"	1/2"	3 1/4"

*O.D. as measured over rubber cushion.

Specifications are subject to change without notice or obligation.

THRUST SLEEVE & SPACER KIT

Developed to eliminate end-play on sleeve bearing blowers. Replaces old style spring design. Plastic sleeve with assortment of spacers make adjustment easy on any size blower.

Easy-to-follow instructions included. Available in 3/4" shaft size only.



Part No. (Pair)*	Shaft Diameter
38220301	3/4"

THRUST COLLAR KIT

Sheet metal thrust collar in 3/4", 5/8" and 1" size. All with hollow head (Allen) setscrews.

Kit consists of one pair packaged with thrust washers. Order by part number.



Part No. (Pair)*	Shaft Diameter
38243101	5/8"
38220601	3/4"
38220701	1"

THRUST SPACER KIT

Packaged 12 per bag.



Part No. (Pair)*	Shaft Diameter
38249101	5/8"
38249102	3/4"
38249103	1"

MOTOR MOUNTING HARDWARE KIT



Motor attachment and adjustment hardware for 9", 10", 12" and 15" blowers.

Part No.
38252101

MOTOR ADJUSTMENT KIT

Tailpiece assembly for proper belt tension adjustment.

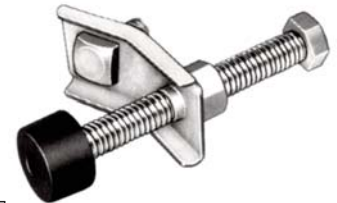

Part No.
38252301

MOTOR ADJUSTMENT GROMMETS

Resilient rubber tips for use with tailpiece assembly to reduce motor vibration and noise.



Part No. (Pack of 6)
38252501

VIBRO-PADS 5/16" HOLE

Resilient rubber pads snap easily into place. Reduces vibration, wear and noise on blowers, fans, motors, etc. (packaged 12 per bag).

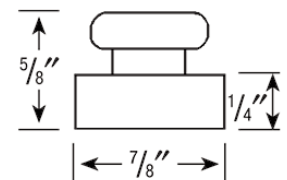

Part No. (Doz.)
38220901



+ Shipped in pairs



PARTS & ACCESSORIES

SHAFTS

SHAFTS

When a bearing fails, the shaft is inevitably scored. If not replaced, it will destroy the new bearings. Premium shafting is ground and polished 1018 cold-rolled steel. Excess shaft may be cut off. (Keyways and/or flats are to be added as required in the field.)



NOTE - When replacing bearings, be sure to replace the shaft.

Part No.	Diameter	Length	Shaft
38220501	5/8"	20"	Solid
38209601	3/4"	20"	Solid
38269301	3/4"	35"	Solid
38209501	1"	25"	Solid
38249201	1"	35"	Solid

TOTALINE® BLOWER SHAFTS

- Solid cold-rolled steel
- Ground and polished shaft
- Universal sizes
- Can be cut to proper length

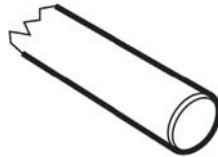

NOTE - When replacing bearings, be sure to replace the shaft.

Part No.	Diameter	Length	Shaft
P461-4520	5/8"	20"	Solid
P461-4320	3/4"	20"	Solid
P461-4335	3/4"	35"	Solid
P461-4125	1"	25"	Solid
P461-4135	1"	35"	Solid

STEEL SHAFT BUSHINGS



Part No.	Inside Diameter	Outside Diameter	Length
P251-0062	5/16"	3/8"	1 1/64"
P251-0063	5/16"	1/2"	1 1/8"
P251-0064	3/8"	1/2"	1 1/8"
P251-0076	1/2"	5/8"	1 1/8"
P251-0065	1/2"	3/4"	1 1/4"
P251-0066	5/8"	3/4"	1 1/4"
P251-0067	5/8"	1"	1 1/4"
P251-0068	3/4"	1"	1 1/4"
P251-0069	1"	1 3/16"	1 1/4"

TOTALINE® ADJUSTABLE MOTOR PULLEYS



- Quality cast iron key way
- Designed for long belt life
- Corrosion resistant

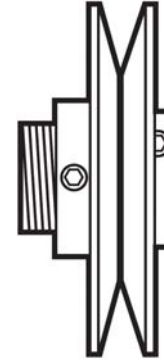

Part No.	Pulley Size	Shaft Size	Pitch Diameter
P461-3201	3"	1/2"	1.9 - 2.9"
P461-3503	3"	5/8"	1.9 - 2.9"
P461-3301	3"	3/4"	1.9 - 2.9"
P461-3202	4"	1/2"	2.4 - 3.4"
P461-3505	4"	5/8"	2.4 - 3.4"
P461-3302	4"	3/4"	2.4 - 3.4"
P461-3710	4"	7/8"	2.4 - 3.4"
P461-3203	4 1/4"	1/2"	2.8 - 3.8"
P461-3507	4 1/4"	5/8"	2.8 - 3.8"
P461-3303	4 1/4"	3/4"	2.8 - 3.8"
P461-3708	4 1/4"	7/8"	2.8 - 3.8"
P461-3204	5"	1/2"	3.4 - 4.4"
P461-3504	5"	5/8"	3.4 - 4.4"
P461-3304	5"	3/4"	3.4 - 4.4"
P461-3706	5"	7/8"	3.4 - 4.4"

CROSS-REFERENCE CHART

Totaline® Aftermarket Motor Cross-Reference Chart

Part #	Description	GE/ Genteq	US Motors/ Emerson	AO Smith
P267-D136	Totaline Belted Blower Motor Split Phase, 1/2HP 115/230V 1725RPM		4114	
P267-9392	Totaline Belted Blower Motor Split Phase, 1/2HP 115V 1725RPM		4293	
P267-9758	Totaline Belted Blower Motor Split Phase, 1/2HP 115V 1725RPM		8200	GF2054
P267-9308	Totaline Belted Blower Motor Split Phase, 1/3HP 230V 1725RPM			GF2034
P267-9309	Totaline Belted Blower Motor Split Phase, 1/3HP 230V 1725RPM		1789	
P267-D231	Totaline Belted Blower Motor Split Phase, 3/4HP 115V 1725RPM		4115	
P267-D232	Totaline Belted Blower Motor Split Phase, 3/4HP 230V 1725RPM		4115	
P267-9784	Totaline Oil Burner Motors Single Phase, 1/6HP 115V 1725RPM	4784	3250	XEL2014, EL2014
P267-9783	Totaline Oil Burner Motors Single Phase, 1/7HP 115V 1725RPM	4779	3083	EL2002, EL2002V1, OCN2002
P267-9782	Totaline Oil Burner Motors Single Phase, 1/8HP 115V 1725RPM	4782	3196	XEL2004, EL2004, EL2005

Cobra Blades Cross-Reference Charts

Standard Catalog 2-Blade Props					2-Blade Cobra Props					3-Blade Cobra Props				
Part No.	Model	Dia.	Pitch	Rot.	Part No.	Model	Dia.	Pitch	Rot.	Part No.	Model	Dia.	Pitch	Rot.
6130580001	S10S08-2424	24"	24°	CCW	6139820001	S10HS6A-2424	24"	24°	CCW	6139720001	T10HS6A-2420	24"	20°	CCW

Standard Catalog 3-Blade Props					3-Blade Cobra Props					4-Blade Cobra Props				
Part No.	Model	Dia.	Pitch	Rot.	Part No.	Model	Dia.	Pitch	Rot.	Part No.	Model	Dia.	Pitch	Rot.
60557301	T12E10-2227	22"	27°	CW	6140720001	T10HS9A-2234	22"	34°	CW	N/A				
6129850001	T12E10-2230	22"	30°	CW	6140720001	T10HS9A-2234	22"	34°	CW	6140730001	F10HS9A-2234	22"	34°	CW
60557501	T12E10-2233	22"	33°	CW	6140720001	T10HS9A-2234	22"	34°	CW	6140730001	F10HS9A-2234	22"	34°	CW
6129870001	T12E10-2235	22"	35°	CW	N/A					6140730001	F10HS9A-2234	22"	34°	CW
60557801	T12E10-2427	24"	27°	CCW	N/A					6139940001	F10HS6A-2428	24"	28°	CCW
60558001	T12E10-2433	24"	33°	CCW	N/A					6140060001	F10HS6A-2434	24"	34°	CCW
61046601	T10S08-2626	26"	26°	CW	6140330001	T10HS8A-2628	26"	28°	CW	N/A				
6129890001	T10E10-2626	26"	26°	CW	6140470001	T10HS8A-2634	26"	34°	CW	N/A				
6129900001	T10E10-2633	26"	33°	CCW	N/A					6140480001	F10HS8A-2634	26"	34°	CCW
6130660001	T10S08-2637	26"	37°	CW	6140470001	T10HS8A-2634	26"	34°	CW	N/A				

Standard Catalog 4-Blade Props					4-Blade Cobra Props					3-Blade Cobra Props				
Part No.	Model	Dia.	Pitch	Rot.	Part No.	Model	Dia.	Pitch	Rot.	Part No.	Model	Dia.	Pitch	Rot.
60804101	F05E10-2223	22"	23°	CW	6140620001	F10HS9A-2224	22"	24°	CW	6140660001	T10HS9A-2228	22"	28°	CW
60559301	F05E10-2227	22"	27°	CW	6140670001	F10HS9A-2228	22"	28°	CW	N/A				
60559501	F05E10-2233	22"	33°	CW	6140730001	F10HS9A-2234	22"	34°	CW	N/A				
6130140001	F05E10-2413	24"	13°	CCW	6139740001	F10HS6A-2420	24"	20°	CCW	N/A				
6130160001	F05E10-2416	24"	16°	CCW	6139740001	F10HS6A-2420	24"	20°	CCW	6139720001	T10HS6A-2420	24"	20°	CCW
6130180001	F05E10-2418	24"	18°	CCW	6139860001	F10HS6A-2424	24"	24°	CCW	6139840001	T10HS6A-2424	24"	24°	CCW
6130200001	F05E10-2420	24"	20°	CCW	6139860001	F10HS6A-2424	24"	24°	CCW	6139840001	T10HS6A-2424	24"	24°	CCW
60804401	F05E10-2423	24"	23°	CCW	6139940001	F10HS6A-2428	24"	28°	CCW	6139920001	T10HS6A-2428	24"	28°	CCW
60559801	F05E10-2427	24"	27°	CCW	6140060001	F10HS6A-2434	24"	34°	CCW	6140040001	T10HS6A-2434	24"	34°	CCW
60760701	F05E10-2624	26"	24°	CW	N/A					6140470001	T10HS8A-2634	26"	34°	CW
60760901	F05E10-2627	26"	27°	CW	6140480001	F10HS8A-2634	26"	34°	CW	N/A				



CROSS-REFERENCE CHART

Totaline® Aftermarket Motor Cross-Reference Chart

Part #	Description	GE/ Genteq	US Motors/ Emerson	AO Smith
P257-8330	Totaline Condenser Fan Motor High Efficiency, 1/2HP 208/230V 1075RPM	3330	1862	FS1056S
P257-8328	Totaline Condenser Fan Motor High Efficiency, 1/4HP 208/230V 1075RPM	3328	1860	FS1026S
P257-8329	Totaline Condenser Fan Motor Single Phase High Eff, 1/3HP 208/230V 1075RPM	3329	5455	FS1037S
P257-8030	Totaline Condenser Fan Motor Single Phase, 1/2HP 208/230V 1075RPM	3030		FS1056
P257-8032	Totaline Condenser Fan Motor Single Phase, 1/2HP 208/230V 1075RPM	3032		F1056
P257-8026	Totaline Condenser Fan Motor Single Phase, 1/3HP 208/230V 1075RPM	3026	1875	F1038
P257-8029	Totaline Condenser Fan Motor Single Phase, 1/3HP 208/230V 1075RPM	3029		FS1036
P257-8031	Totaline Condenser Fan Motor Single Phase, 1/3HP 208/230V 1075RPM	3031		F1036
P257-8028	Totaline Condenser Fan Motor Single Phase, 1/4HP 208/230V 1075RPM	3028		FS1026
P257-8046	Totaline Condenser Fan Motor Single Phase, 1/4HP 208/230V 1075RPM			F1026
P257-8048	Totaline Condenser Fan Motor Single Phase, 3/4HP 208/230V 1075RPM	3048		F1076
P257-8730	Totaline Condenser Fan Motor, 1/2HP 230V 1075RPM	3730	1862	FSE1056S
P257-8729	Totaline Condenser Fan Motor, 1/3HP 230V 1075RPM	3729	1861	FSE1036S
P257-8728	Totaline Condenser Fan Motor, 1/4HP 230V 1075RPM	3728	1860	FSE1026S
P257-8727	Totaline Condenser Fan Motor, 1/6HP 230V 1075RPM	3727	1859	FSE1016S
P257-8731	Totaline Condenser Fan Motor, 3/4HP 230V 1075RPM	3731	1868	FSE1076S
P257-E380	Totaline Condenser Fan Motor Three Phase, 1-1/2HP 208-230/460V 1140RPM		1819	
P257-E379	Totaline Condenser Fan Motor Three Phase, 1HP 208-230/460V 1140RPM		1818	
P257-E378	Totaline Condenser Fan Motor Three Phase, 3/4HP 208-230/460V 1140RPM		1817	
P257-8230	Totaline Condenser Fan Motor, 1/2HP 208/230V 1075RPM	3230	8671	FSE1056
P257-8229	Totaline Condenser Fan Motor, 1/3HP 208/230V 1075RPM	3229	8670	FSE1036
P257-8228	Totaline Condenser Fan Motor, 1/4HP 208/230V 1075RPM	3228		FSE1026
T257-3730	TotalSaver Condenser Fan Motor, 1/2HP 230V 1075RPM	3730	1862	FSE1056S
T257-3729	TotalSaver Condenser Fan Motor, 1/3HP 230V 1075RPM	3729	1861	FSE1036S
T257-3728	TotalSaver Condenser Fan Motor, 1/4HP 230V 1075RPM	3728	1860	FSE1026S
T257-3727	TotalSaver Condenser Fan Motor, 1/6HP 230V 1075RPM	3727	1859	FSE1016S
T257-3731	TotalSaver Condenser Fan Motor, 3/4HP 230V 1075RPM	3731	1868	FSE1076S
P257-E5465	Totaline Condenser Fan Motors Multi-Horsepower, 1/2-1/5HP 208/230V 1075 RPM	3468	5465	FE6002
P257-E5462	Totaline Condenser Fan Motors Multi-Horsepower, 1/3-1/6HP 208/230V 1075 RPM	3465	5462	FE6000
P257-E5464	Totaline Condenser Fan Motors Multi-Horsepower, 1/3-1/6HP 208/230V 825 RPM	3469	5464	FE6001
T257-3468	TotalSaver Condenser Fan Motor Multi-Horsepower, 1/5-1/2HP 208/230V 1075RPM	3468	5465	FE6002
T257-3469	TotalSaver Condenser Fan Motor Multi-Horsepower, 1/6-1/3HP 208/230V 825RPM	3469	5464	FE6001
T257-3465	TotalSaver Condenser Fan Motor, 1/3-1/6HP 208/230V 1075RPM	3465	5462	FE6000
P257-E5460	Totaline Direct Drive Blower Motors Multi-Horsepower, 1/2-1/6HP 115V 1075 RPM	3463	5460	FDL6001
P257-E5461	Totaline Direct Drive Blower Motors Multi-Horsepower, 1/2-1/6HP 208/230V 1075 RPM	3464	5461	FDL6000
P257-E5470	Totaline Direct Drive Blower Motors, 1/5-3/4HP 115V 1075 RPM	3466	5470	FDL6002
P257-E5471	Totaline Direct Drive Blower Motors, 1/5-3/4HP 208/230V 1075 RPM	3467	5471	FD6001
T257-3466	TotalSaver Direct Drive Blower Motor Multi-Horsepower, 1/5-3/4HP 115V 1075RPM	3466	5470	FDL6002
T257-3463	TotalSaver Direct Drive Blower Motor Multi-Horsepower, 1/2-1/6HP 115V 1075RPM	3463	5460	FDL6001
T257-3464	TotalSaver Direct Drive Blower Motor Multi-Horsepower, 1/2-1/6HP 208/230V 1075 RPM	3464	5461	FDL6000
T257-3467	TotalSaver Direct Drive Blower Motor Multi-Horsepower, 1/5-3/4HP 208/230V 1100RPM	3467	5471	FD6001
P257-8987	Totaline Direct Drive Blower Motor, High Eff, 1/2HP 115V 1075RPM	3987	1865	FDL1056
P257-8988	Totaline Direct Drive Blower Motor, High Eff, 1/2HP 208/130V 1075RPM	3988	1973	FD1056
P257-8985	Totaline Direct Drive Blower Motor, High Eff, 1/3HP 115V 1075RPM	3985	1864	FDL1036
P257-8986	Totaline Direct Drive Blower Motor, High Eff, 1/3HP 208/130V 1075RPM	3986	1972	FD1036
P257-8983	Totaline Direct Drive Blower Motor, High Eff, 1/4HP 115V 1075RPM	3983	1863	FDL1026
P257-8984	Totaline Direct Drive Blower Motor, High Eff, 1/4HP 208/230V 1075RPM	3984	1971	FD1026
P257-8989	Totaline Direct Drive Blower Motor, High Eff, 3/4HP 115V 1075RPM	3989	8904	FDL1076



Totaline® - A long established quality aftermarket motor to repair other equipment brands.
 TotalSaver® - The competitive fighting brand motor that will be beneficial for situations that require a quality economic alternative.
 Having these aftermarket motors available will ensure that you have what you need to get the job done no matter the equipment brand.

CROSS-REFERENCE CHART

Part #	Wagner	Source 1	Smart	Gemline	Marathon	Mars	Fasco	Packard	Nordyne/ Partners Choice	Rheem/ Ruud Protech	ROTOM
P257-8330					X221		D745				
P257-8328					X213		D749				
P257-8329					X214		D748				
P257-8030					X084						
P257-8032					X096						
P257-8026	WG840205	S1-FHM3205			X086	10405	D796	30825	0167		R22345
P257-8029					X082						
P257-8031					X083						
P257-8028					X080						
P257-8046											
P257-8048											
P257-8730	WG840730	S1-FHM3730	SE3730	EM3730	X221	10730	D907	43730	01-0163	W51-12CJA1-01	
P257-8729	WG840729	S1-FHM3729	SE3729	EM3729	X214	10729	D908	43729	01-0162	W51-13CJA1-01	
P257-8728	WG840728	S1-FHM3728	SE3728	EM3728	X213	10728	D909	43728	01-0161	W51-14CJA1-01	
P257-8727	WG840727	S1-FHM3727	SE3727		X411	10727	D917	43727	01-0160	W51-16CJA1-01	
P257-8731	WG840731	S1-FHM3731	SE3731			10731	D933	43731	01-0164	51-42534-19	
P257-E380											
P257-E379											
P257-E378											
P257-8230											
P257-8229											
P257-8228											
T257-3730	WG840730	S1-FHM3730	SE3730	EM3730	X221	10730	D907	43730	01-0163	W51-12CJA1-01	
T257-3729	WG840729	S1-FHM3729	SE3729	EM3729	X214	10729	D908	43729	01-0162	W51-13CJA1-01	
T257-3728	WG840728	S1-FHM3728	SE3728	EM3728	X213	10728	D909	43728	01-0161	W51-14CJA1-01	
T257-3727	WG840727	S1-FHM3727	SE3727		X411	10727	D917	43727	01-0160	W51-16CJA1-01	
T257-3731	WG840731	S1-FHM3731	SE3731			10731	D933	43731	01-0164	51-42534-19	
P257-E5465	WG840468	S1-FHM3468	SE3468			10468			01-0697		R22602
P257-E5462	WG840465	S1-FHM3465	SE3465			10465	D2827		01-0695	51-23053-21	R22605
P257-E5464	WG840469	S1-FHM3469	SE3469			10469	D2826		01-0696	51-20760-11	R22601
T257-3468	WG840468	S1-FHM3468	SE3468			10468			01-0697		R22602
T257-3469	WG840469	S1-FHM3469	SE3469			10469	D2826		01-0696	51-20760-11	R22601
T257-3465	WG840465	S1-FHM3465	SE3465			10465	D2827		01-0695	51-23053-21	R22605
P257-E5460	WG840463	S1-FHM3463	SE3463			10463	D2835		01-0698	51-23012-41	R43600
P257-E5461	WG840464	S1-FHM3464	SE3464			10464	D833		01-0699	51-23022-41	R43601
P257-E5470	WG840466	S1-FHM3466	SE3466			10466	D2832		01-0702		R43602
P257-E5471	WG840467	S1-FHM3467	SE3467			10467	D2833		01-0701		R43603
T257-3466	WG840466	S1-FHM3466	SE3466			10466	D2832		01-0702		R43602
T257-3463	WG840463	S1-FHM3463	SE3463			10463	D2835		01-0698	51-23012-41	R43600
T257-3464	WG840464	S1-FHM3464	SE3464			10464	D833		01-0699	51-23022-41	R43601
T257-3467	WG840467	S1-FHM3467	SE3467			10467	D2833		01-0701		R43603
P257-8987											
P257-8988											
P257-8985											
P257-8986											
P257-8983											
P257-8984											
P257-8989											

GE, Emerson, Wagner, Source 1, Smart Electric, AO Smith, Gemline, and Marathon are trademarks of their respective owners. Reasonable effort has been made to assure the accuracy of the cross-reference information. However, final evaluation for suitable replacement is left to the installer



CROSS-REFERENCE CHART

Totaline® Aftermarket Motor Cross-Reference Chart - continued

Part #	Description	GE/ Genteq	US Motors/ Emerson	AO Smith
P257-8990	Totaline Direct Drive Blower Motor, High Eff, 3/4HP 208/230V 1075RPM	3990	8905	FD1076
P257-8587	Totaline Direct Drive Blower Motor, 1/2HP 115V 1075RPM	3587	1865	FDL1056
P257-8588	Totaline Direct Drive Blower Motor, 1/2HP 208/230V 1075RPM	3588	1973	FD1056
P257-8585	Totaline Direct Drive Blower Motor, 1/3HP 115V 1075RPM	3585	1864	FDL1036
P257-8586	Totaline Direct Drive Blower Motor, 1/3HP 208/230V 1075RPM	3586	1972	FD1036
P257-8583	Totaline Direct Drive Blower Motor, 1/4HP 115V 1075RPM	3583	1863	FDL1026
P257-8584	Totaline Direct Drive Blower Motor, 1/4HP 208/230V 1075RPM	3584	1971	D1026
P257-8589	Totaline Direct Drive Blower Motor, 3/4HP 115V 1075RPM	3589	8904	DL1076
P257-8590	Totaline Direct Drive Blower Motor, 3/4HP 230V 1075RPM	3590	8905	D1076
P257-8388	Totaline Direct Drive Blower Motor, 1/2HP 208/230V 1075RPM	3388		D1056
P257-8387	Totaline Direct Drive Blower Motor, 1/2HP 115V 1075RPM	3387		DL1056
P257-8385	Totaline Direct Drive Blower Motor, 1/3HP 115V 1075RPM	3385		DL1036
P257-8386	Totaline Direct Drive Blower Motor, 1/3HP 208/230V 1075RPM	3386		D1036
P257-8383	Totaline Direct Drive Blower Motor, 1/4HP 115V 1075RPM	3383	3197	DL1026
P257-8384	Totaline Direct Drive Blower Motor, 1/4HP 208/230V 1075RPM	3384		D1026
P257-8389	Totaline Direct Drive Blower Motor, 3/4HP 115V 1075RPM	3389		DL1076
P257-8390	Totaline Direct Drive Blower Motor, 3/4HP 208/230V 1075RPM	3390		D1076
T257-3587	TotalSaver Direct Drive Blower Motor, 1/2HP 115V 1075RPM	3587	1865	FDL1056
T257-3588	TotalSaver Direct Drive Blower Motor, 1/2HP 230V 1075RPM	3588	1973	FD1056
T257-3585	TotalSaver Direct Drive Blower Motor, 1/3HP 115V 1075RPM	3585	1864	FDL1036
T257-3586	TotalSaver Direct Drive Blower Motor, 1/3HP 230V 1075RPM	3586	1972	FD1036
T257-3583	TotalSaver Direct Drive Blower Motor, 1/4HP 115V 1075RPM	3583	1863	FDL1026
T257-3584	TotalSaver Direct Drive Blower Motor, 1/4HP 230V 1075RPM	3584	1971	D1026
T257-3589	TotalSaver Direct Drive Blower Motor, 3/4HP 115V 1075RPM	3589	8904	DL1076
T257-3590	TotalSaver Direct Drive Blower Motor, 3/4HP 230V 1075RPM	3590	8905	D1076



Totaline® - A long established quality aftermarket motor to repair other equipment brands.

TotalSaver® - The competitive fighting brand motor that will be beneficial for situations that require a quality economic alternative.

Having these aftermarket motors available will ensure that you have what you need to get the job done no matter the equipment brand.

CROSS-REFERENCE CHART:

Part #	Wagner	Source 1	Smart	Gemline	Marathon	Mars	Fasco	Packard	Nordyne/ Partners Choice	Rheem/ Ruud Protech	ROTOM
P257-8990											
P257-8587	WG840587	S1-FHM3587	SE3587	EM3587	X004	10587	D701	43587	01-0171	W51-12BAA3-01	DD-3587
P257-8588	WG840588	S1-FHM3588	SE3588	EM3588	X005	10588	D703	43588	01-0175	W51-12BJA3-01	DD-3588
P257-8585	WG840585	S1-FHM3585	SE3585	EM3585	X002	10585	D701	43585	01-0170	W51-13BAA3-01	DD-3585
P257-8586	WG840586	S1-FHM3586	SE3586	EM3586	X003	10586	D923	43586	01-0174	W51-13BJA3-01	DD-3586
P257-8583	WG840583	S1-FHM3583	SE3583	EM3583		10583	D721	43583	01-0169	W51-14BAA3-01	DD-3583
P257-8584	WG840584	S1-FHM3584	SE3584	EM3584	X001	10584	D727	43584	01-0173	W51-14BJA3-01	DD-3584
P257-8589	WG840589	S1-FHM3589	SE3589	EM3589	X009	10589	D278	43589	01-0172	W51-34BAA3-01	DD-3589
P257-8590	WG840590	S1-FHM3590	SE3590	EM3590	X010	10590	D729	43590	01-0176	W51-34BJA3-01	DD-3590
P257-8388											
P257-8387											
P257-8385											
P257-8386											
P257-8383											
P257-8384											
P257-8389											
P257-8390											
T257-3587	WG840587	S1-FHM3587	SE3587	EM3587	X004	10587	D701	43587	01-0171	W51-12BAA3-01	DD-3587
T257-3588	WG840588	S1-FHM3588	SE3588	EM3588	X005	10588	D703	43588	01-0175	W51-12BJA3-01	DD-3588
T257-3585	WG840585	S1-FHM3585	SE3585	EM3585	X002	10585	D701	43585	01-0170	W51-13BAA3-01	DD-3585
T257-3586	WG840586	S1-FHM3586	SE3586	EM3586	X003	10586	D923	43586	01-0174	W51-13BJA3-01	DD-3586
T257-3583	WG840583	S1-FHM3583	SE3583	EM3583		10583	D721	43583	01-0169	W51-14BAA3-01	DD-3583
T257-3584	WG840584	S1-FHM3584	SE3584	EM3584	X001	10584	D727	43584	01-0173	W51-14BJA3-01	DD-3584
T257-3589	WG840589	S1-FHM3589	SE3589	EM3589	X009	10589	D278	43589	01-0172	W51-34BAA3-01	DD-3589
T257-3590	WG840590	S1-FHM3590	SE3590	EM3590	X010	10590	D729	43590	01-0176	W51-34BJA3-01	DD-3590

GE, Emerson, Wagner, Source 1, Smart Electric, AO Smith, Gemline, and Marathon are trademarks of their respective owners. Reasonable effort has been made to assure the accuracy of the cross-reference information. However, final evaluation for suitable replacement is left to the installer



TOTALINE

TOTALINE®

Solving challenging HVAC/R problems is your job. Helping you get the parts, supplies and equipment you need is ours. This is the Totaline commitment; we don't take it lightly.

Heating, ventilation, air conditioning, refrigeration... at Totaline, you'll find parts, supplies, equipment and tools for residential and commercial applications. But it goes beyond that. Our counter sales associates are the best-trained in the industry. They'll help you get what you need and get back to the job.

Make Totaline a daily stop. You'll find the big stuff... a compressor selection that will cover almost any application... but you'll also find the little things that are easy, yet painful, to forget. Duct tape? Wasp spray? Tools? Find it all at Totaline.

For the Totaline® location nearest you visit

www.totaline.com

For technical information visit

www.hvacpartners.com

TOTALINE®