



WIRE ROPE AND SLING BASICS

Wire rope slings are both flexible and resistant to abrasion. These characteristics are determined by the rope construction. Fewer wires result in larger diameter wires, better abrasion resistance, and reduced flexibility. More wires result in decreased wire diameter, reduced abrasion resistance, increased flexibility, and kink resistance.

The scale below shows the relative position of the sling constructions shown in this catalog as they pertain to abrasion resistance and flexibility.

- EIPS** = **Extra Improved Plow Steel**
- FC** = **Fiber Core**
- IWRC** = **Independent Wire Rope Core**

Wire Rope Construction

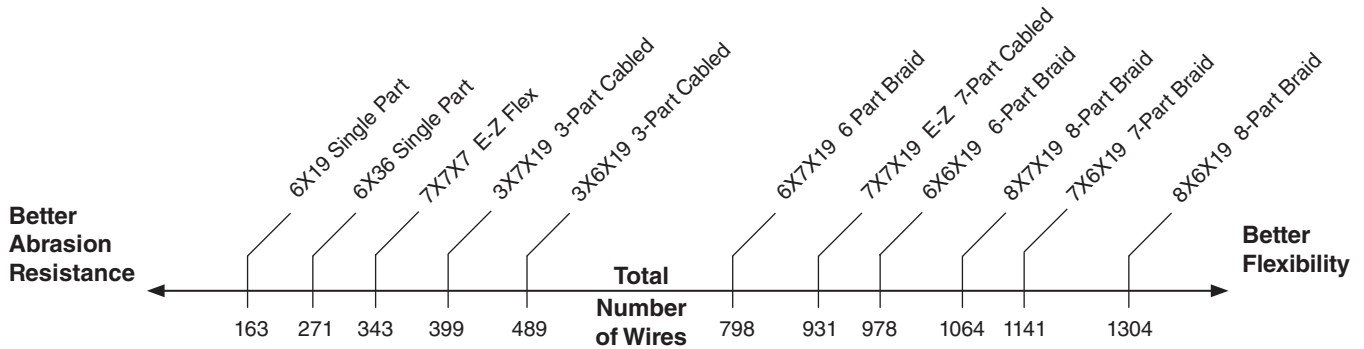
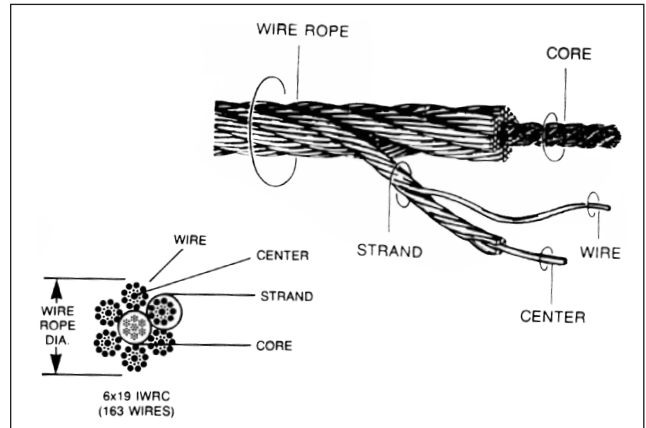

Wire Rope

WIRE ROPE SLINGS

Features and Benefits

- *Tuff-Tag* for capacity and serial numbered identification for traceability and compliance with OSHA.
- Least expensive (per capacity), of all steel slings.
- Use of IWRC EIPS rope gives 15% greater capacity than IWRC IP (Improved Plow) ropes.
- Countless combinations of sling terminations: hooks, chokers, and thimbles are available to fit specific lift requirements.

Environmental Considerations

- IWRC must not be used at temperatures above 400°F.
- FC must not be used at temperatures above 180°F.
- Fiber core ropes should not be subjected to degreasing solvents.

D/d - Basket Hitch Effect

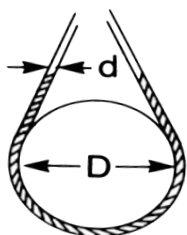

Tests have shown that when a sling body is bent around a diameter, the strength of the sling is decreased. D/d ratio is the ratio of the diameter around which the sling is bent, divided by the body diameter of the sling.

The capacities in this catalog are based on the minimum D/d ratios that appear below each of the capacity tables. For more severe bending conditions, contact *Lift-All* for revised capacities.

Effect of Shackle Pin or Crane Hook on Sling Eye



Damage to slings can occur if the wrong size pin or hook is used. The width of the hook should never exceed the natural inside width of the eye.

The eye dimension for each type and size of the slings are shown in the capacity tables of this catalog. If your pin or hook is large, request an oversized eye.

HOW TO ORDER WIRE ROPE SLINGS

Prior to sling selection and use, review and understand the General Information section in this catalog. We have developed the following wire rope sling code system to help you in ordering these products.

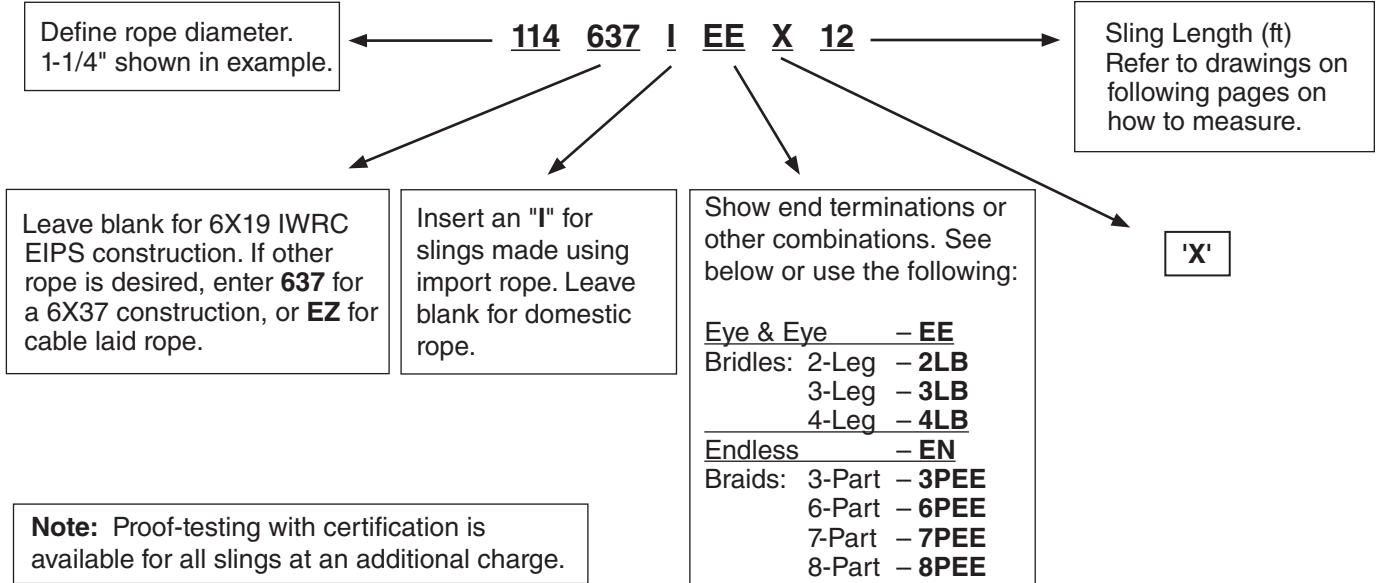

Wire Rope

Standard Combinations

Eye & Eye (E/E)	Thimble & Crescent Thimble (T/CT)
Eye & Thimble (E/T)	Thimble & Slip-Thru Thimble (T/ST)
Eye & Hook (E/TH)	Crescent Thimble & Hook (CT/TH)
Eye & Crescent Thimble (E/CT)	Crescent Thimble & (CT/CT) Crescent Thimble
Eye & Slip-Thru Thimble (E/ST)	Slip-Thru Thimble & Hook (ST/TH)
Thimble & Thimble (T/T)	Slip-Thru Thimble & Slip-Thru Thimble (ST/ST)
Thimble & Hook (T/TH)	

Sliding Choker

Eye & Thimble (E/T/SCH)
Eye & Eye (E/E/SCH)

Tolerances and Minimum Lengths
Refer to tables for tolerances and minimum lengths.

Stretch
Approximately 1% at rated capacity.

Wire Rope Class
Standard rope classes are shown for each type and size of sling in the charts. Specific rope constructions are available upon request.

PERMALOC™ WIRE ROPE SLINGS

Lift-All Permaloc slings are made using the Flemish Eye splice technique to form the eyes. Unlike the simple return loop method that places 100% of its strength on the swaged sleeve, *Permaloc* slings have reserve strength should the sleeve become damaged in use.

Features and Benefits

Maintains all the basic *Lift-All* wire rope sling features plus ...

Promotes Safety

- Reserve strength: Integrity of eyes not solely dependent upon steel sleeves.
- IWRC resists crushing better than FC ropes.

Saves Money

- When specified, thimble eyes protect wire rope from wear for increased life.
- Good abrasion resistance for longer life.

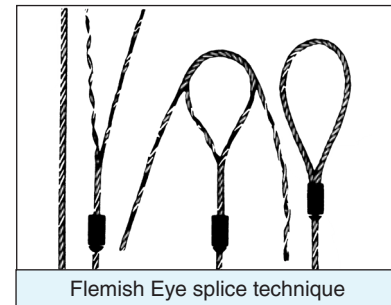

Wire Rope

Wire Rope Class		EIPS IWRC				Fiber core available at reduced capacities					
		Rated Capacity* (tons)			Min. Sling Length	Standard Eye Size W X L (in.)	Thimbled Eye Size W X L (in.)	Eye Hook Cap. (tons)	Crescent Thimble Eye Size W X L (in.)	Slip Thru Thimble Eye Size W X L (in.)	Sliding Choker Hook ** (in.)
Rope Dia. (in.)	Vertical	Choker	Vertical Basket								
6X19 EIPS IWRC	1/4	.65	.48	1.3	1'-6"	2 X 4	0.88 X 1.63	1	2 X 4	2.13 X 4.13	3/8
	5/16	1.0	.74	2.0	1'-9"	2.5 X 5	1.06 X 1.88	1	2 X 4	2.50 X 4.13	3/8
	3/8	1.4	1.1	2.9	2'-0"	3 X 6	1.13 X 2.13	1.5	2 X 4	2.50 X 4.13	3/8
	7/16	1.9	1.4	3.9	2'-3"	3.5 X 7	1.25 X 2.25	2	2 X 5	2.38 X 4.38	1/2
	1/2	2.5	1.9	5.1	2'-6"	4 X 8	1.5 X 2.75	3	2.25 X 6	2.38 X 4.38	1/2**
	9/16	3.2	2.4	6.4	2'-9"	4.5 X 9	1.5 X 2.75	4.5	2.25 X 7	2.38 X 4.38	5/8
	5/8	3.9	2.9	7.8	3'-0"	5 X 10	1.75 X 3.25	4.5	2.75 X 7	3.38 X 6.63	5/8**
	3/4	5.6	4.1	11	3'-6"	6 X 12	2 X 3.75	7	3.25 X 8.5	3.38 X 6.63	3/4**
	7/8	7.6	5.6	15	4'-0"	7 X 14	2.25 X 4.25	11	4.5 X 10	3.75 X 7.13	7/8
	1	9.8	7.2	20	4'-6"	8 X 16	2 X 4.5	11	4.5 X 11.5	3.75 X 7.13	1
6X37 EIPS IWRC	1-1/8	12	9.1	24	5'-0"	9 X 18	2.88 X 5.13	15	4.88 X 13	4.38 X 8.38	1-1/8
	1-1/4	15	11	30	5'-6"	10 X 20	3.5 X 6.5	15	5.5 X 14.5	4.38 X 8.38	1-1/4
	1-3/8	18	13	36	6'-0"	11 X 22	3.5 X 6.25	22	6 X 16	5 X 9.5	1-3/8
	1-1/2	21	16	42	7'-0"	12 X 24	3.5 X 6.25	22	6 X 17.5	5 X 9.5	1-1/2**
	1-3/4	28	21	57	8'-0"	14 X 28	4.5 X 9	30	7 X 20	6.75 X 11.75	-
	2	37	28	73	9'-0"	16 X 32	6 X 12	37	7 X 23.5	8 X 14.5	-
	2-1/4	44	35	89	10'-0"	18 X 36	7 X 14	45	8.5 X 26	8 X 15.5	-
2-1/2	54	42	109	11'-0"	20 X 40	-	-	8.5 X 29.5	-	-	

¹ Minimum sling length when using standard eyes.

** See sliding choker hook capacities in Hardware section when using these hooks.

Note: Larger diameter slings available. Basket ratings are based on a minimum D/d of 25.

Length Tolerances (Single Part Wire Rope Slings): Standard length tolerance is plus or minus two rope diameters, **OR** plus or minus 0.5% of the sling length, whichever is greater.

*** WARNING** Do not exceed rated capacities. Sling capacity decreases as the angle from horizontal decreases. Slings should not be used at angles of less than 30°. Refer to the Effect of Angle chart in the General Information section of this catalog.

PERMALOC™ BRIDLE SLINGS

Features and Benefits

Maintains all the basic *Lift-All* wire rope sling features plus ...

- Bridles provide better load control and balance.
- Independent wire rope core resists crushing.
- Alloy steel hardware assures long life.
- Thimble eyes protect wire rope from wear for increased life.
- Reduces load damage by using fixed points on load.
- Easier rigging provided when hooking into fixed lifting points.

Bridle Slings (With Single Part Body)				2-Leg Bridle				3-Leg Bridle				4-Leg Bridle			
				6X19				6X37				6X19 EIPS IWRC			
Rope Dia. (in.)	Min. Sling Length	Eye Hook Cap. (tons)	Rated Capacity* (tons)			Oblong Link Stock Dia. (in.)	Rated Capacity* (tons)			Oblong Link Stock Dia. (in.)	Rated Capacity* (tons)			Oblong Link Stock Dia. (in.)	
			60°	45°	30°		60°	45°	30°		60°	45°	30°		
1/4	1'-3"	1	1.1	.91	.65	1/2	1.7	1.4	.97	1/2	2.2	1.8	1.3	1/2	
5/16	1'-6"	1	1.7	1.4	1.0	1/2	2.6	2.1	1.5	1/2	3.5	2.8	2.0	3/4	
3/8	1'-8"	1-1/2	2.5	2.0	1.4	1/2	3.7	3.0	2.2	3/4	5.0	4.1	2.9	3/4	
7/16	1'-10"	2	3.4	2.7	1.9	3/4	5.0	4.1	2.9	3/4	6.7	5.5	3.9	1	
1/2	2'-0"	3	4.4	3.6	2.5	3/4	6.6	5.4	3.8	1	8.8	7.1	5.1	1	
9/16	2'-2"	4-1/2	5.5	4.5	3.2	3/4	8.3	6.8	4.8	1	11	9.0	6.4	1-1/4	
5/8	2'-4"	4-1/2	6.8	5.5	3.9	1	10	8.3	5.9	1-1/4	14	11	7.8	1-1/2	
3/4	2'-9"	7	9.7	7.9	5.6	1-1/4	15	12	8.4	1-1/2	19	16	11	1-3/4	
7/8	3'-3"	11	13	11	7.6	1-1/4	20	16	11	1-1/2	26	21	15	2	
1	3'-6"	11	17	14	9.8	1-1/2	26	21	15	1-3/4	34	28	20	2-1/4	
1-1/8	4'-0"	15	21	17	12	1-1/2	31	26	18	1-3/4	42	34	24	2-3/4	
1-1/4	4'-6"	15	26	21	15	1-3/4	38	31	22	2	51	42	30	2-3/4	
1-3/8	5'-0"	22	31	25	18	1-3/4	46	38	27	2-1/4	-	-	-	-	
1-1/2	5'-6"	22	37	30	21	2	55	45	32	2-1/4	-	-	-	-	
1-3/4	6'-6"	30	49	40	28	2-1/4	-	-	-	-	-	-	-	-	
2	8'-0"	37	63	52	37	2-3/4	-	-	-	-	-	-	-	-	

¹ Minimum length based on thimble eye and eye.

Other fittings and latches are available upon request.

Length Tolerances (Single Part Wire Rope Slings): Standard length tolerance is plus or minus two rope diameters, **OR** plus or minus 0.5% of the sling length, whichever is greater. The legs of bridle slings, or matched slings are normally held to within one rope diameter.

Import hooks with latches standard on import rope bridles. Domestic hooks with optional latches are standard on domestic rope bridles.

*** WARNING** Do not exceed rated capacities. Sling capacity decreases as the angle from horizontal decreases. Slings should not be used at angles of less than 30°. Refer to the Effect of Angle chart in the General Information section of this catalog.

ENDLESS SLINGS

Made from one 6X19 or 6X37 EIPS IWRC wire rope, mechanically joined with steel sleeves. Achieves higher capacities at a lower cost.

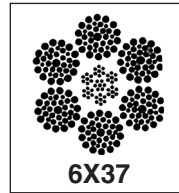
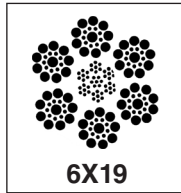

Features and Benefits

Maintains all the basic *Lift-All* wire rope sling features plus ...

Promotes Safety

- Load stability and balance can be achieved by spreading sling legs in a basket or choker hitch.

Saves Money

- Wear points can be shifted to extend sling life.
- The most versatile style of sling - fewer slings to inventory.

Saves Time

- More flexible than eye slings of comparable strength.
- Ideal for turning loads.

Wire Rope

⚠ WARNING

Do not lift with hook in splice area as sling damage may occur.

Endless – Mechanical Splice					
 Rope Dia. (in.)	Rated Capacity* (tons)			Minimum Sling Length	Splice Length A (in.)
	 Vertical	 Choker	 Vertical Basket		
1/4	1.0	.71	2.0	3'-0"	8
5/16	1.6	1.1	3.1	3'-0"	8
3/8	2.3	1.6	4.5	3'-0"	8
7/16	3.1	2.1	6.1	6'-0"	10
1/2	3.9	2.8	7.9	6'-0"	10
9/16	5.0	3.5	10	6'-0"	10
5/8	6.1	4.3	12	6'-0"	10
3/4	8.8	6.2	18	8'-0"	16
7/8	12	8.3	24	8'-0"	18
1	15	11	31	8'-0"	20

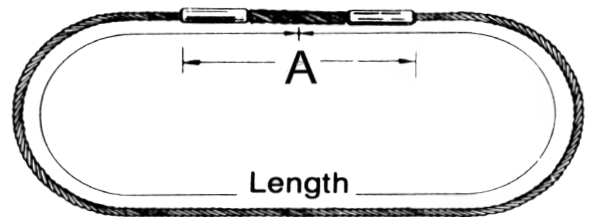

Order length by circumference

Notes:

1. Three sleeves used on 3/4" diameter and larger.
2. Vertical and Basket ratings are based on a minimum D/d of 5.

Do not lift with hook in splice area as sling damage may occur.

* **⚠ WARNING** Do not exceed rated capacities. Sling capacity decreases as the angle from horizontal decreases. Slings should not be used at angles of less than 30°. Refer to the Effect of Angle chart in the General Information section of this catalog.

E-Z FLEX™ CABLE LAID SLINGS

E-Z Flex slings are made from a machine laid rope that consists of seven individual, galvanized ropes.

Features and Benefits

Maintains all the basic *Lift-All* wire rope sling features plus ...

Saves Money

- Superior flexibility - resists damage from kinking.
- Galvanized coating for corrosion resistance and longer life.

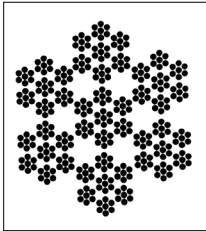

7X7X7

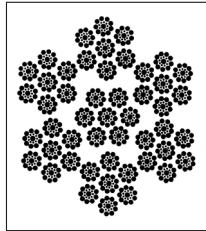

7X7X19



Standard Combinations	
	Eye & Eye (E/E)
	Eye & Thimble (E/T)
	Eye & Hook (E/TH)
	Eye & Crescent Thimble (E/CT)
	Eye & Slip-Thru Thimble (E/ST)
	Slip-Thru Thimble & Hook (ST/TH)
	Slip-Thru Thimble & Slip-Thru Thimble (ST/ST)
	Thimble & Thimble (T/T)

Rope Diameter (in.)	Rated Capacity* (tons)			**Min. Sling Length	Standard Eye Size (in.) W X L	Thimbled Eye Size (in.) W X L	Eye Hook Cap. (tons)	Crescent Thimble Eye Size (in.) W X L	Slip Thru Thimble Eye Size (in.) W X L	Sliding Choker Hook (in.)	
	Vertical	Choker	Vertical Basket								
7X7X7	1/4	.50	.34	1'-6"	2 X 4	.88 X 1.63	1	2 X 4	2.13 X 4.13	3/8	
	3/8	1.1	.74	2'-0"	3 X 6	1.13 X 2.125	1.5	2 X 4	2.13 X 4.13	3/8	
	1/2	1.9	1.3	2'-6"	4 X 8	1.5 X 2.75	2	2.25 X 6	2.38 X 4.38	1/2	
	5/8	2.8	1.9	5.5	3'-0"	5 X 10	1.75 X 3.25	3	2.75 X 7	3.38 X 6.63	5/8
7X7X19	3/4	4.1	2.8	8.1	3'-6"	6 X 12	2 X 3.75	4.5	3.25 X 8.5	3.38 X 6.63	3/4
	7/8	5.4	3.7	11	4'-0"	7 X 14	2.25 X 4.25	7	4.5 X 10	3.75 X 7.13	7/8
	1	6.9	4.7	14	4'-6"	8 X 16	2.5 X 4.5	7	4.5 X 11.5	3.75 X 7.13	1
	1-1/8	8.3	5.8	17	5'-0"	9 X 18	2.88 X 5.13	11	4.88 X 13	4.38 X 8.38	1-1/8
	1-1/4	9.9	7.0	20	5'-6"	10 X 20	3.5 X 6.5	11	5.5 X 14.5	4.38 X 8.38	1-1/4
	1-1/2	13	9.1	26	7'-0"	12 X 24	3.5 X 6.25	15	6 X 17.5	5 X 9.5	1-1/2

**Minimum sling length when using standard eyes. Basket ratings are based on a minimum D/d of 10.

Other fittings are available upon request.

Hooks with latches are standard on import assemblies; optional on domestic.

* **WARNING** Do not exceed rated capacities. Sling capacity decreases as the angle from horizontal decreases. Slings should not be used at angles of less than 30°. Refer to the Effect of Angle chart in the General Information section of this catalog.

E-Z FLEX™ TWO LEG BRIDLE SLINGS

Features and Benefits

Maintains all the basic *Lift-All* wire rope sling features plus ...

Promotes Safety

- Bridles provide better load control and balance.

Saves Money

- Excellent flexibility - resists damage from kinking.
- Galvanized coating for corrosion resistance and longer life.
- Alloy steel hardware assures long life.

Saves Time

- Easier rigging when hooking into fixed lifting points.
- Sliding choker hook speeds rigging of bundled materials.

⚠ WARNING

Do not lift with hook in splice area as sling damage may occur.

Wire Rope

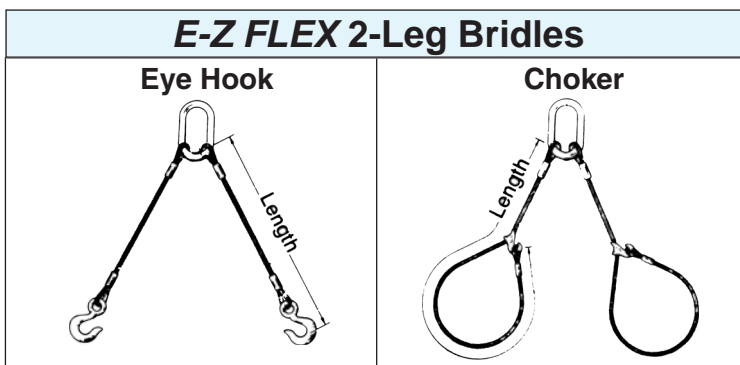

		Rated Capacity* (tons)									
Rope Dia. (in.)		60°	45°	30°	60°	45°	30°	**Min. Sling Length	Oblong Link Stock Dia. (in.)	Eye Hook Cap. (tons)	Sliding Choker Hook (in.)
7X7X7	1/4	.87	.71	.50	.60	.49	.34	1'-3"	1/2	1	3/8
	3/8	1.9	1.5	1.1	1.3	1.0	.74	1'-8"	1/2	1-1/2	3/8
	1/2	3.2	2.6	1.9	2.2	1.8	1.3	2'-0"	3/4	2	1/2
	5/8	4.8	3.9	2.8	3.3	2.7	1.9	2'-4"	1	3	5/8
7X7X19	3/4	7.0	5.8	4.1	4.8	3.9	2.8	2'-9"	1	4-1/2	3/4
	7/8	9.4	7.6	5.4	6.4	5.2	3.7	3'-3"	1	7	7/8
	1	12	9.7	6.9	8.2	6.7	4.7	3'-6"	1 1-1/4	7	1
	1-1/8	14	12	8.3	10	8.2	5.8	4'-0"	1-1/2	11	1-1/8
	1-1/4	17	14	9.9	12	9.8	7.0	4'-6"	1-1/2	11	1-1/4
	1-1/2	22	18	13	15	13	9.1	5'-6"	2	15	1-1/2

** Minimum length based on thimble eye and eye hook.

* **⚠ WARNING** Do not exceed rated capacities. Sling capacity decreases as the angle from horizontal decreases. Slings should not be used at angles of less than 30°. Refer to the Effect of Angle chart in the General Information section of this catalog.

E-Z FLEX™ ENDLESS SLINGS

Features and Benefits

Maintains all the basic *Lift-All* wire rope sling features plus ...

Promotes Safety

- Load stability and balance achieved by spreading sling legs in basket and choker hitches.

Saves Money

- Wear points can be shifted to extend sling life.
- Smaller rope diameter per capacity increases flexibility.

Saves Time

- Ideal for turning loads.
- More flexible than eye slings of comparable strength.

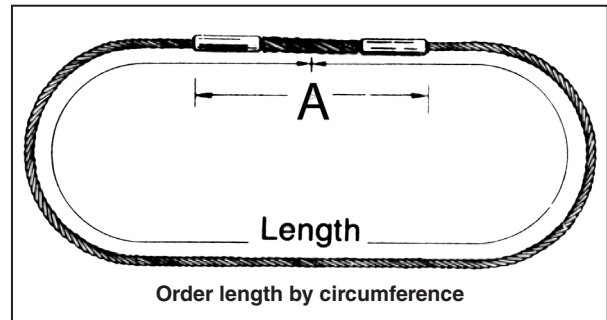

Note: Three sleeves used on 3/4" diameter and larger

Wire
Rope

E-Z FLEX Endless Slings						
Rope Dia. (in.)	Rated Capacity* (tons)			Min. Sling Length	Splice Length A (in.)	
	Vertical	Choker	Vertical Basket			
7X7X7	1/4	.83	.54	1.7	2'-3"	10
	3/8	1.8	1.2	3.6	3'-0"	10
	1/2	3.0	2.0	6.1	4'-0"	12
	5/8	4.6	3.0	9.1	5'-0"	12
7X7X19	3/4	6.7	4.3	13	6'-0"	18
	7/8	8.9	5.8	18	7'-0"	18
	1	11	7.3	23	8'-0"	20

Vertical and Basket ratings are based on a minimum D/d of 5.

⚠ WARNING

Do not lift with hook in splice area as sling damage may occur.

* **⚠ WARNING** Do not exceed rated capacities. Sling capacity decreases as the angle from horizontal decreases. Slings should not be used at angles of less than 30°. Refer to the Effect of Angle chart in the General Information section of this catalog.

HIDDEN TUCK HAND SPLICED SLINGS

Features and Benefits

Maintains all the basic *Lift-All* wire rope sling features plus ...

Promotes Safety



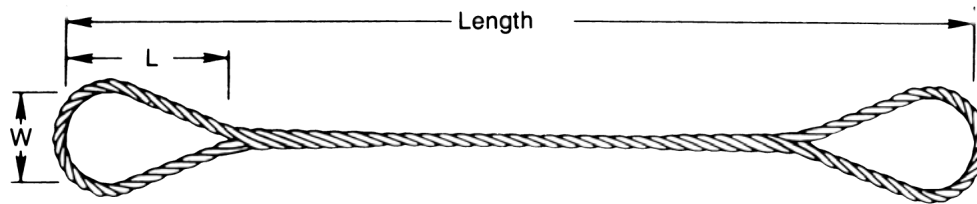
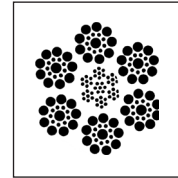

- Hidden Tuck buries wire ends to avoid snags and injuries.

Saves Time

- No steel sleeves to catch under load.



Wire Rope

Hidden Tuck Hand Spliced – Fiber Core						
 Rope Dia. (in.)	EIPS FC			Min. Sling Length	 Standard Eye Size W x L (in.)	
	Rated Capacity* (tons)					
	 Vertical	 Choker	 Vertical Basket			
6X19 EIPS FC	1/4	.54	.42	1.1	2'-0"	3 X 6
	5/16	.83	.66	1.7	2'-3"	3 X 6
	3/8	1.2	.94	2.4	2'-6"	3 X 6
	7/16	1.6	1.3	3.2	2'-9"	3.5 X 7
	1/2	2.0	1.6	4.0	3'-0"	4 X 8
	9/16	2.5	2.1	5.0	3'-6"	4.5 X 9
	5/8	3.1	2.6	6.2	4'-0"	5 X 10
	3/4	4.3	3.7	8.6	4'-6"	6 X 12
	7/8	5.7	5.0	11	5'-6"	7 X 14
	1	7.4	6.4	15	6'-0"	8 X 16

Basket ratings are based on a minimum D/d of 15.

*** WARNING** Do not exceed rated capacities. Sling capacity decreases as the angle from horizontal decreases. Slings should not be used at angles of less than 30°. Refer to the Effect of Angle chart in the General Information section of this catalog.

MULTI-PART CABLED SLINGS

3-Part Cabled

Constructed by hand cabling one rope to form a 3-part body with 2-part eyes.

Features and Benefits

Maintains all the basic *Lift-All* wire rope sling features plus ...

Saves Money

- Good abrasion resistance increases useful life of sling.
- Resists damage from kinking.

Saves Time

- Flexible and easy to handle.
- Small sleeve over component rope won't get in the way.

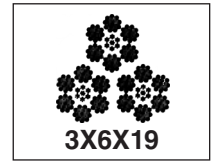
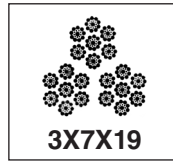

3-Part Cabled									
Component Rope (in.)	Sling Body Dia. (in.)	Rated Capacity* (tons)			Min. Sling Length	Standard Eye W X L (in.)	Crescent Thimble Eye Size W X L (in.)	Slip-Thru Thimble Eye Size W X L (in.)	
		Vertical	Choker	Vertical Basket					
7X19 GAC	3/16	3/8	1.2	.82	2.4	2'-0"	3 X 6	2 X 4	2.13 X 4.13
	1/4	1/2	1.9	1.3	3.9	2'-6"	4 X 8	2.25 X 4	2.38 X 4.38
	5/16	5/8	3.0	2.1	6.0	3'-0"	5 X 10	2.75 X 5	3.38 X 6.63
	3/8	3/4	4.3	2.9	8.6	3'-6"	6 X 12	3.25 X 6	3.38 X 6.63
6X19 EIPS IWRC	7/16	7/8	5.8	4.0	12	4'-0"	7 X 14	4.5 X 9	3.75 X 7.13
	1/2	1	7.6	5.2	15	4'-6"	8 X 16	4.5 X 9	3.75 X 7.13
	9/16	1-1/8	9.6	6.6	19	5'-0"	9 X 18	4.88 X 10	4.38 X 8.38
	5/8	1-1/4	12	8.0	23	5'-6"	10 X 20	5.5 X 11	4.38 X 8.38
	3/4	1-1/2	17	11	34	7'-0"	11 X 22	6 X 12	5 X 9.5

Basket ratings based on a minimum D/d of 10 (using sling body dia.).

7-Part Cabled

Constructed by hand cabling one rope to form a 7-part body with 4-part eyes.

Features and Benefits

Maintains all the basic *Lift-All* wire rope sling features plus

Saves Money

- Resists damage from kinking.

Saves Time

- Superior flexibility makes sling easy to rig and use.
- Small sleeve over component rope won't get in the way.

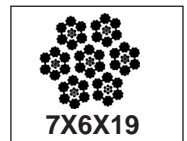
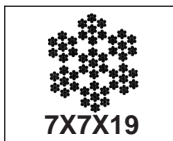

7-Part Cabled									
Component Rope Dia. (in.)	Sling Body Dia. (in.)	Rated Capacity* (tons)			Min. Sling Length	Standard Eye W X L (in.)	Crescent Thimble Eye Size W X L (in.)	Slip-Thru Thimble Eye Size W X L (in.)	
		Vertical	Choker	Vertical Basket					
7X19 GAC	1/8	3/8	1.3	.91	2.6	2'-0"	3 X 6	2 X 4	2.13 X 4.13
	3/16	9/16	2.8	1.9	5.6	2'-6"	4 X 8	2.25 X 6	2.38 X 4.38
	1/4	3/4	4.7	3.2	9.3	3'-0"	5 X 10	2.75 X 7	3.38 X 6.63
	5/16	15/16	6.5	4.5	13	3'-6"	6 X 12	3.25 X 8.50	3.75 X 7.13
	3/8	1-1/8	9.6	6.6	19	4'-0"	7.5 X 15	4.50 X 10	3.75 X 7.13
6X19	7/16	1-5/16	14	9.3	27	4'-6"	9 X 18	4.88 X 13	4.38 X 8.38
	1/2	1-1/2	18	12	35	5'-0"	10 X 20	5.50 X 14.50	4.38 X 8.38

Basket ratings based on a minimum D/d of 10 (using sling body dia.). See first page of WIRE ROPE section.

*** WARNING**

Do not exceed rated capacities. Sling capacity decreases as the angle from horizontal decreases. Slings should not be used at angles of less than 30°. Refer to the Effect of Angle chart in the General Information section of this catalog.

MULTI-PART BRAIDED SLINGS

6-Part Flat Braid

Constructed by braiding one rope to form a 6-part flat body with web seized eyes.

Features and Benefits

Maintains all the basic *Lift-All* wire rope sling features plus ...

Promotes Safety

- Wide bearing surface provides better load control and balance.
- Resists rotation, improving load control.

Saves Money

- Resists damage from kinking.
- Reduces load damage.

Saves Time

- Flexible - easy to rig.

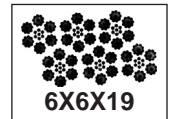
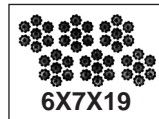

6-Part Flat Braid									
Component Rope Dia. (in.)	Sling Body Dia. (in.)	Rated Capacity* (tons)			Min. Sling Length	Standard Eye W x L (in.)	Crescent Thimble Eye Size W x L (in.)	Slip-Thru Thimble Eye Size W x L (in.)	
		Vertical	Choker	Vertical Basket					
7X19 GAC	1/8	9/16 X 3/8	.84	.74	1.7	2'-0"	3 X 6	2 X 4	2.13 X 4.13
	3/16	13/16 X 1/2	1.8	1.5	3.5	3'-0"	4 X 8	2.25 X 7.0	2.38 X 4.38
	1/4	1-1/8 X 11/16	2.9	2.6	5.9	3'-6"	5 X 10	3.25 X 8.5	3.38 X 6.63
	5/16	1-3/8 X 7/8	4.1	3.6	8.2	4'-6"	6 X 12	4.5 X 11.5	3.38 X 6.63
	3/8	1-11/16 X 1	6.0	5.3	12	5'-0"	7 X 14	4.88 X 13	3.75 X 7.13
6X19 EIPS IWRC	7/16	2 X 1-3/16	8.6	7.5	17	6' 0"	8 X 16	6.0 X 16	3.75 X 7.13
	1/2	2-1/4 X 1-5/16	11	9.8	22	6' 6"	9 X 18	6.0 X 17.5	4.38 X 8.38
	9/16	2-1/2 X 1-1/2	14	12	28	7' 0"	10 X 20	7.0 X 20	4.38 X 8.38
	5/8	2-13/16 X 1-11/16	17	15	35	8' 0"	11 X 22	7.0 X 23.5	5.0 X 9.50
	3/4	3-3/8 X 2	25	22	49	9' 0"	12 X 24	8.5 X 26	6.75 X 11.75

Basket ratings based on a minimum D/d of 10 (using sling body dia.). See 1st pg. of WIRE ROPE sec.

8-Part Round Braid

Constructed by braiding one rope to form an 8-part round body with 4-part web seized eyes.

Features and Benefits

Maintains all the basic *Lift-All* wire rope sling features plus ...

Promotes Safety

- Resists rotation, for improved load control.

Saves Money

- The most kink-resistant wire rope sling available.
- Greater flexibility for reduced load damage.

Saves Time

- Flexible - easy to rig.

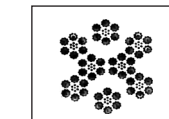
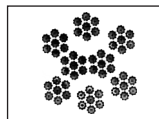

8-Part Round Braid									
Component Rope Dia. (in.)	Sling Body Dia. (in.)	Rated Capacity* (tons)			Min. Sling Length	Standard Eye W x L (in.)	Crescent Thimble Eye Size W x L (in.)	Slip Thru Thimble Eye Size W x L (in.)	
		Vertical	Choker	Vertical Basket					
7X19 GAC	1/8	9/16	1.1	1.0	2.2	2'-0"	3 X 6	2 X 4	2.13 X 4.13
	3/16	13/16	2.4	2.1	4.7	3'-0"	4 X 8	2.25 X 6	2.38 X 4.38
	1/4	1-1/8	3.9	3.4	7.8	3'-6"	5 X 10	3.25 X 8	3.38 X 6.63
	5/16	1-3/8	5.5	4.8	11	4'-6"	6 X 12	4.50 X 10	3.75 X 7.13
	3/8	1-1/16	8.1	7.1	16	5'-0"	7 X 14	4.63 X 12	3.75 X 7.13
6X19 EIPS IWRC	7/16	2	11	10	23	6' 0"	8 X 16	5.50 X 14	4.38 X 8.38
	1/2	2-1/4	15	13	30	6' 6"	9 X 18	6.0 X 16	5.00 X 9.50
	9/16	2-1/2	19	16	38	7' 0"	10 X 20	6.50 X 18	5.00 X 9.50
	5/8	2-13/16	23	20	46	8' 0"	11 X 22	7.0 X 20	6.75 X 11.75
	3/4	3-3/8	33	29	66	9' 0"	12 X 24	8.0 X 24	8.00 X 14.50

Basket ratings based on a minimum D/d of 10 (using sling body dia.). See 1st pg. of WIRE ROPE sec.



Do not exceed rated capacities. Sling capacity decreases as the angle from horizontal decreases. Slings should not be used at angles of less than 30°. Refer to the Effect of Angle chart in the General Information section of this catalog.

Wire Rope

ADJUST-A-LEG[®] Adjustable 2-Leg Wire Rope Slings

Features and Benefits

- Easy to adjust legs for a level lift of unbalanced and non-symmetrical loads.
- Can be locked in place for repetitive lifts.
- Use in pairs for 4-Point lifts.
- Can be used as top rigging for spreader beams.
- Great as rigging to move machinery.

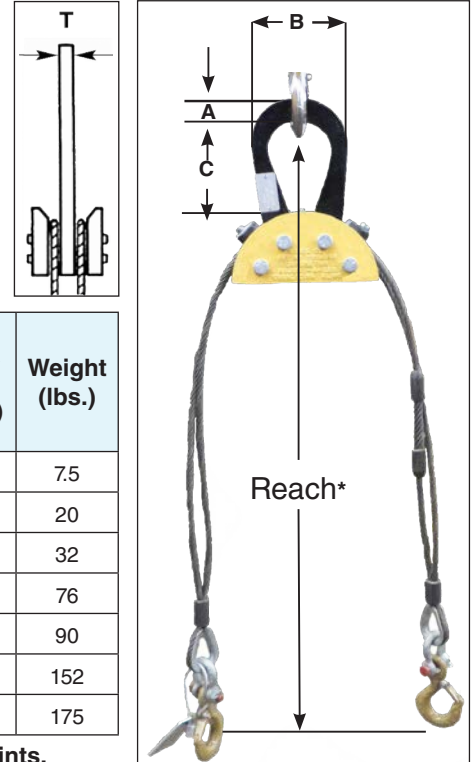

Rated Capacity Legs @ 45° (tons)	Part Number	Standard Reach* (ft.)	Rope Diameter (in.)	Top Assembly A • B • C • T (in.)	Hook Size (tons)	Weight (lbs.)
1	AAL1	3	5/16	1.13 • 3.13 • 5.00 • 0.63	1	7.5
2	AAL2	4	5/16	1.13 • 3.13 • 5.00 • 0.63	1-1/2	20
4	AAL4	6	7/16	1.13 • 3.13 • 5.00 • 0.63	3	32
6	AAL6	9	9/16	1.75 • 5.25 • 8.38 • 0.81	5	76
8	AAL8	9	5/8	1.75 • 5.25 • 8.38 • 0.88	7	90
12	AAL12	9	3/4	2.38 • 5.63 • 8.75 • 1.06	11	152
15	AAL15	9	7/8	2.38 • 5.63 • 8.75 • 1.06	11	175

* Reach should be a length of 70% or greater of the distance between pick up points.

Operation:

For a level lift, adjust the leg lengths so that the master plate is above the approximate center of gravity. Test position by lifting only until one end of the load is raised. Lower and reposition master plate and legs for another test. Repeat until load raises without tilting. **Adjust-A-Leg must be loaded to at least 10% of rated capacity before legs will fully lock into place.**

Typical Applications

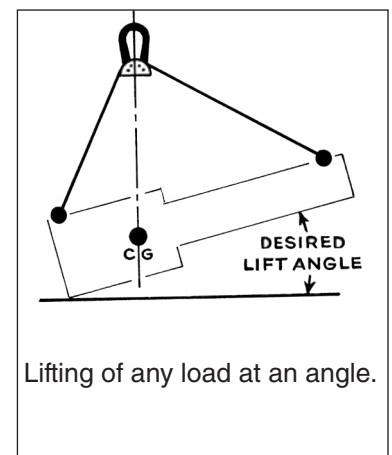
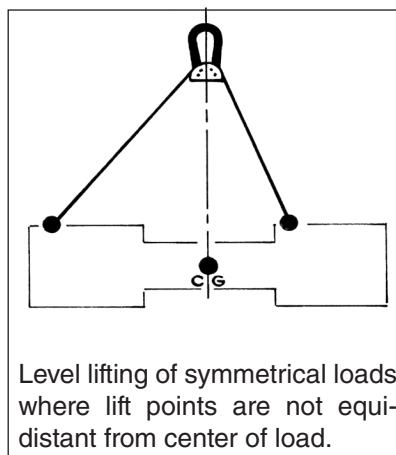
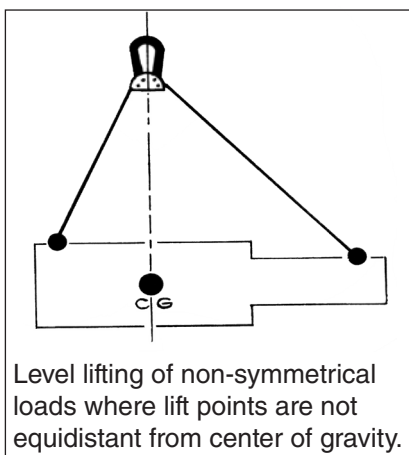

Adjust-A-Leg[®] is a registered trademark of Caldwell Group Lifting Solutions.

SWAGED THREADED STUDS

- Choice of studs made of specially selected carbon steel or stainless steel.
- Custom OEM engineering available.

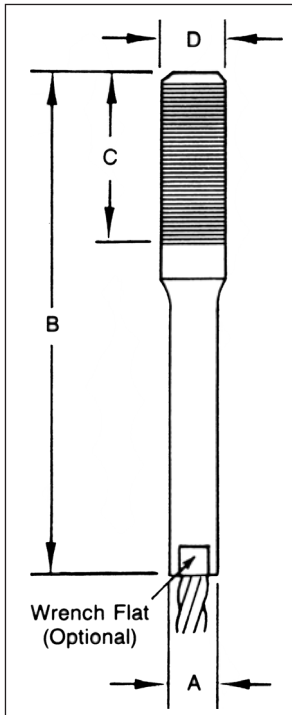

Straight Threaded Studs								
Part Number	Rope Dia (in.)	Nominal Breaking Strength* (tons)	Dimensions (in.)				N.C.** Thread	N.F. Thread
			After Swage A	Approx. B	C	D		
STS-8	1/4	3.4	0.44	4.06	1.50	0.50	13	20
STS-10	5/16	5.3	0.56	5.25	1.88	0.63	11	18
STS-12	3/8	7.6	0.63	6.25	2.25	0.75	10	16
STS-14	7/16	10.2	0.75	7.31	2.63	0.88	9	14
STS-16	1/2	13.3	0.88	8.25	3.00	1.00	8	14
STS-18	9/16	16.8	1.00	9.25	3.38	1.13	7	12
STS-20	5/8	20.6	1.13	10.13	3.75	1.25	7	12
STS-24	3/4	29.4	1.25	12.81	4.50	1.50	6	12
STS-28	7/8	39.5	1.50	14.56	5.25	1.75	5	12
STS-32	1	51.7	1.75	16.25	6.00	2.00	4.5	12
STS-36	1-1/8	65.0	2.00	18.25	6.75	2.25	4.5	12
STS-40	1-1/4	79.9	2.25	20.25	7.50	2.50	4	12

* Nominal Breaking Strength based on 6X19 or 6X37 IWRC EIPS wire rope, with assembly used as a straight tension member.

** N.C. - Coarse threads are standard

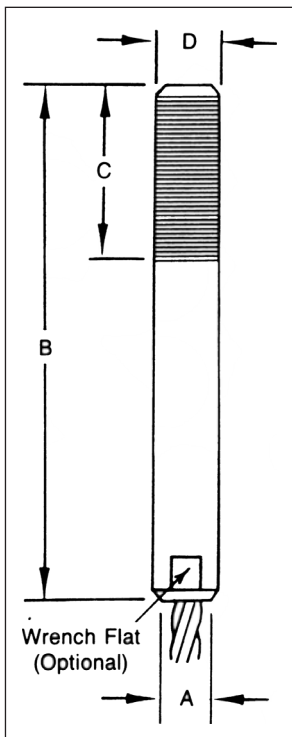

Turned Threaded Studs								
Part Number	Rope Dia (in.)	Nominal Breaking Strength* (tons)	Dimensions (in.)				N.C.** Thread	N.F. Thread
			After Swage A	Approx. B	C	D		
TTS-10	5/16	5.3	0.63	5.72	1.75	0.63	11	18
TTS-12	3/8	7.6	0.75	6.75	2.00	0.75	10	16
TTS-14	7/16	10.2	0.88	7.66	2.25	0.88	9	14
TTS-16	1/2	13.3	1.00	8.56	2.50	1.00	8	14
TTS-18	9/16	16.8	1.13	9.63	2.75	1.13	7	12
TTS-20	5/8	20.6	1.25	10.66	3.13	1.25	7	12
TTS-24	3/4	29.4	1.50	12.69	3.75	1.50	6	12
TTS-28	7/8	39.5	1.75	14.63	4.38	1.75	5	12
TTS-32	1	51.7	2.00	16.66	5.00	2.00	4.5	12
TTS-36	1-1/8	65.0	2.25	18.63	5.63	2.25	4.5	12
TTS-40	1-1/4	79.9	2.50	20.66	6.25	2.50	4	12
TTS-44	1-3/8	96.0	2.75	22.53	6.88	2.75	4	12
TTS-48	1-1/2	114	3.00	24.50	7.50	3.00	4	12

* Nominal Breaking Strength based on 6X19 or 6X37 IWRC EIPS wire rope, with assembly used as a straight tension member.

** N.C. - Coarse threads are standard

SWAGED SOCKET ASSEMBLIES

Features and Benefits

Promotes Safety

- Achieves 100% of nominal rope breaking strength.
- All assemblies are proof-tested before shipment.

Saves Money

- Custom engineered assemblies are available for specific rigging needs.

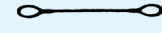
 Rope Diameter (in.)	Minimum Pendant Length	 Vertical Capacity* (tons)
1/4	11'-0"	0.68
5/16	1'-3"	1.1
3/8	1'-3"	1.5
7/16	1'-8"	2.0
1/2	1'-8"	2.7
9/16	2'-0"	3.4
5/8	2'-0"	4.1
3/4	2'-5"	5.9
7/8	2'-10"	8.0
1	3'-2"	10
1-1/8	3'-7"	13
1-1/4	4'-0"	16

* Values given apply to 6X19 or 6X37 IWRC EIPS rope when pendants are used for slings. If used as boom suspension system or other applications, contact *Lift-All* for ratings.

Open Swaged Sockets

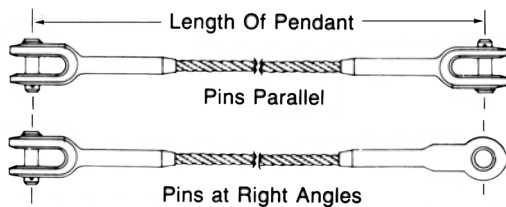

Open & Closed Swaged Sockets

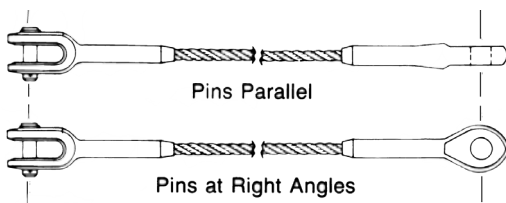

Closed Swaged Sockets

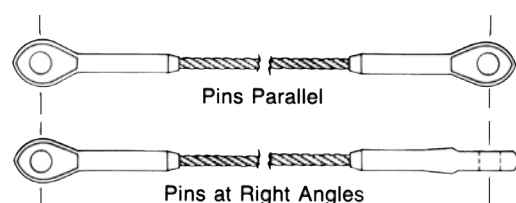

Swage Socket Dimensions – Forged Steel

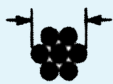
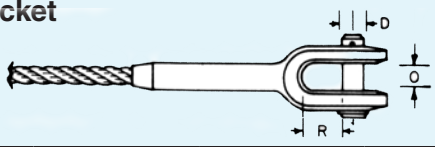
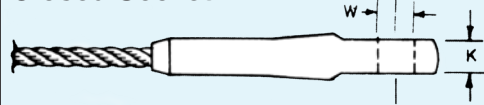
 Rope Dia. (in.)	Open Socket 				Closed Socket 		
	R (in.)	O (in.)	D (in.)	Weight (lbs.)	W (in.)	K (in.)	Weight (lbs.)
1/4	1.16	0.69	0.69	0.52	0.75	0.50	0.38
5/16	1.34	0.82	0.82	1.12	0.88	0.69	0.77
3/8	1.34	0.82	0.82	1.25	0.88	0.69	0.72
7/16	1.50	1.00	1.00	2.08	1.06	0.88	1.42
1/2	1.50	1.00	1.00	2.08	1.06	0.88	1.35
9/16	1.63	1.25	1.19	4.48	1.25	1.13	2.92
5/8	1.63	1.25	1.19	4.75	1.25	1.13	2.85
3/4	2.00	1.50	1.38	7.97	1.44	1.31	4.90
7/8	2.38	1.75	1.63	11.30	1.69	1.50	6.63
1	2.75	2.00	2.00	17.80	2.06	1.75	10.30
1-1/8	3.13	2.25	2.25	27.50	2.31	2.00	14.50
1-1/4	3.50	2.50	2.50	35.75	2.56	2.25	20.75

Wire Rope

HOIST LINES AND STEEL BUTTONS

Hoist Line Cables

Lift-All hoist lines are made using 6X19 IWRC wire core ropes for better resistance to abrasion and crushing. Available with carbon hooks for large throat openings, or alloy hooks for longer life.

Features and Benefits

Promotes Safety

- *Permaloc™* Flemish Eye splice for high strength efficiency.
- Meets OSHA 1910.184 and ASME B30.9.

Saves Money

- Heavy-duty thimble in eye extends useful life.
- Economical custom assemblies.

Saves Time

- No assembly time - ready to install.
- Stainless steel latch keeps hook in proper place.



Running lengths of cable with thimble eye ends available

6X19 Class - Bright (Uncoated)	
Diameter (in.)	Break Strength
	IWRC
3/8	14,000-lbs.
7/16	19,000-lbs.
1/2	25,000-lbs.
9/16	32,000-lbs.
5/8	39,000-lbs.

Swaged Steel Buttons

Swaged steel buttons are designed for use as end stops on drum winding equipment such as hoists and winches.

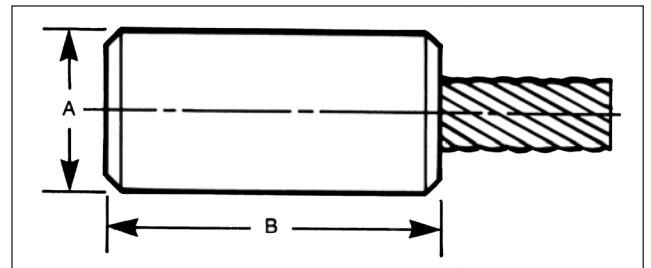

Wire Rope

After Swage Dimensions

Rope Diameter (in.)	A (approx.)	B (approx.)
1/4	0.63	1.13
5/16	0.75	1.50
3/8	0.88	1.75
7/16	1.00	2.00
1/2	1.13	2.38
9/16	1.25	2.63
5/8	1.38	2.88
3/4	1.50	3.50
7/8	1.75	4.13
1	2.00	4.75
1-1/8	2.25	5.25
1-1/4	2.50	5.88
1-3/8	2.75	6.50
1-1/2	3.00	7.13

Non-standard buttons are available.

WIRE ROPE



These high quality wire ropes are available in cut lengths or by the reels.

Wire Rope

Wire Core	
Extra Improved Plow Steel (EIPS) Higher Capacities	
6X19 Class	6X19
Six Strand Ropes Having 9 to 26 Wires Per Strand <i>Better Abrasion Resistance</i>	
6X37 Class	6X37
Six Strand Ropes Having 27 to 49 Wires Per Strand <i>More Flexible</i>	

Rotation Resistant Wire Rope			
19X7	Rope Dia. (in.)	Approx. Weight per Foot (lbs.)	Nominal Breaking Strength (tons)
	3/8	0.25	6.15
	7/16	0.35	8.33
	1/2	0.45	10.8
	9/16	0.58	13.6
	5/8	0.71	16.8
	3/4	1.02	24.0
	7/8	1.39	32.5
	1	1.82	42.2
	1-1/8	2.30	53.1

Rope Diameter (in.)	Approx. Weight per Foot (lbs.)	Nominal Breaking Strength (tons)
1/4	0.12	3.40
5/16	0.18	5.27
3/8	0.26	7.55
7/16	0.35	10.2
1/2	0.46	13.3
9/16	0.59	16.8
5/8	0.72	20.6
3/4	1.04	29.4
7/8	1.42	39.8
1	1.85	51.7
1-1/8	2.34	65.0
1-1/4	2.89	79.9
1-3/8	3.50	96.0
1-1/2	4.16	114
1-5/8	4.88	132
1-3/4	5.67	153
1-7/8	6.50	174
2	7.39	198

The Nominal Breaking Strength of wire rope should be considered the straight line pull, which will ACTUALLY BREAK a new, UNUSED, rope (with both rope ends fixed to prevent rotation). The Nominal Breaking Strength of the rope should NEVER BE USED AS ITS WORKING LOAD.

To determine the working load of a wire rope, the MINIMUM or NOMINAL Breaking Strength MUST BE REDUCED by a DESIGN FACTOR. The design factor will vary depending upon the type of machine and installation, and the work permitted. YOU must determine the applicable Design Factor for your use.

For example, a Design Factor of "5" means that the Minimum or Nominal Breaking Strength of the wire rope must be DIVIDED BY FIVE to determine the maximum load that can be applied to the rope system.

Design Factors have been established by OSHA, by ANSI, by ASME, and similar government and industrial organizations.

No wire rope should ever be installed or used without full knowledge and consideration of the Design Factor for the application.

The above is based on the 'Wire Rope Safety Bulletin' published by the "WIRE ROPE TECHNICAL BOARD."

Note: Specialty ropes are available upon request.

CABLE & COMPONENTS

Galvanized & Stainless Steel Cable					
7X7 	Cable Diameter (in.)	Weight per Reel (lbs.)	Standard Length (ft./Reel)	Nominal Break Strength (lbs.)	
				Galvanized Cable (GAC)	Stainless Steel Cable (SSAC) Type 304
				1/16	5
3/32	9	500	920	820	
1/8	15	500	1,700	1,500	
5/32	16	250	2,600	n/a	
3/16	26	250	3,700	n/a	
1/4	28	250	6,100	n/a	

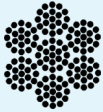
7X19 	3/32	9	500	1,000	920
	1/8	15	500	2,000	1,760
	5/32	12	250	2,800	2,400
	3/16	17	250	4,200	3,700
	1/4	25	250	7,000	6,400
	5/16	38	200	9,800	9,000
	3/8	52	200	14,400	12,000

Galvanized Cable Coated W/Clear Vinyl (VGAC)					
Galvanized Cable Construction	Cable Diameter (in.)	Coated to (in.)	Weight per Reel (lbs.)	Standard Length (ft./Reel)	Nominal Break Strength (lbs.)
7X7	1/16	3/32	7	500	480
	3/32	3/16	7	250	920
	1/8	3/16	10	250	1,700
7X19	1/8	3/16	10	250	2,000
	3/16	1/4	19	200	4,200
	1/4	5/16	28	200	7,000

STANDARD THIMBLES					
Rope Dia. (in.)	Dimensions (in.)			Quantity Per Bag	Weight Per Bag (lbs.)
	A	B	C		
1/8	1.31	0.69	0.25	100	4
3/16	1.31	0.69	0.31	100	4
1/4	1.31	0.69	0.38	100	4
5/16	1.50	0.82	0.44	80	3
3/8	1.63	0.94	0.50	80	4



Wire Rope

Heavy Duty Thimbles				
Rope Diameter (in.)	Dimensions (in.)			Weight Each (lbs.)
	A	B	C	
1/4	1.63	0.88	0.44	0.08
5/16	1.88	1.06	0.53	0.14
3/8	2.13	1.13	0.66	0.22
7/16	2.32	1.25	0.75	0.36
1/2	2.75	1.50	0.94	0.51
9/16	2.75	1.50	1.00	0.35
5/8	3.25	1.75	1.03	0.75
3/4	3.75	2.00	1.25	1.47
7/8	4.25	2.25	1.44	1.85
1	4.50	2.50	1.69	3.00
1-1/8	5.13	2.88	1.81	4.00
1-1/4	6.50	3.50	2.19	8.17
1-3/8 & 1-1/2	6.25	3.50	2.56	11.75
1-5/8	8.00	4.00	2.72	17.00
1-3/4	9.00	4.50	2.84	17.75
1-7/8 & 2	12.0	6.00	3.09	25.00
2-1/4	14.0	7.00	3.63	39.50

CABLE & COMPONENTS

Wire Rope Clips

The following instructions, supplied by the Wire Rope Technical Board, will result in an approximate 80% efficiency rating when the clips are applied, as instructed, on GAC, SSAC, RRL or RLL; 6X19 class or 6X37 class; fiber core or IWRC non-Seale type construction wire rope. If applying to vinyl-coated ropes, strip the vinyl from the connection area first.

How to Apply Clips

1. Turn back the specified amount of rope from the thimble. Apply the first clip, fastening it one clip width from the dead-end of the wire rope (U-bolt over dead-end; live end rests in clip saddle). Tighten nuts evenly to recommended torque.
2. Apply the next clip as close to the loop as possible. Turn nuts firmly but do not tighten.
3. If required, place additional clips equally between the first two. Tighten nuts; take up rope slack; tighten all nuts evenly on all clips to recommended torque.
4. **NOTICE!** Apply the initial load and re-tighten nuts to the recommended torque. Wire rope will stretch, and diameter is reduced when a load is applied. Inspect periodically and re-tighten to recommended torque.

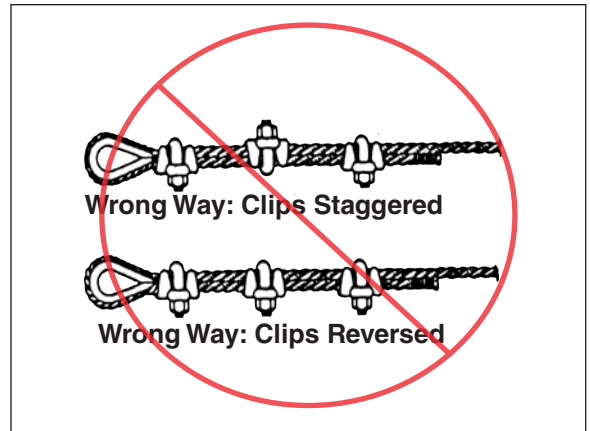
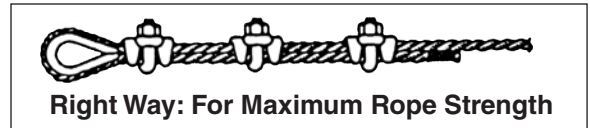

⚠ WARNING
Failure to make a termination in accordance with aforementioned instructions, or failure to periodically check and re-tighten to the recommended torque, may result in death or serious injury.



Drop Forged Wire Rope Clips				
Rope Dia. (in.)	Minimum Number of Clips	Rope Turn-back (in.)	Torque (ft./lbs.)	Weight Each (lbs.)
1/8	2	3.25	4.5	.06
3/16	2	3.75	7.5	.10
1/4	2	4.75	15	.18
5/16	2	5.25	30	.30
3/8	2	6.50	45	.47
7/16	2	7.00	65	.76
1/2	3	11.5	65	.80
9/16	3	12.0	95	1.04
5/8	3	12.0	95	1.06
3/4	4	18.0	130	1.50
7/8	4	19.0	225	2.12
1	5	26.0	225	2.50
1-1/8	6	34.0	225	2.80
1-1/4	7	44.0	360	4.15
1-3/8	7	44.0	360	4.60
1-1/2	8	54.0	360	5.30

Malleable Wire Rope Clips*					
Rope Dia. (in.)	Minimum Number of Clips	Rope Turn-back (in.)	Torque (ft./lbs.)	Quantity Per Bag	Weight Per Bag (lbs.)
1/8	3	5	3	200	10
3/16	3	6	5	150	12
1/4	3	7	15	100	12
5/16	3	8	15	100	15
3/8	3	10	30	50	11

* Malleable clips are not to be used for overhead lifting. Use in light duty, non-critical applications only.

INSPECTION CRITERIA FOR WIRE ROPE SLINGS

Remove slings from service when:

- Capacity information is missing or illegible.
- End attachments (including hooks) are cracked, deformed, or obviously worn.

- Hook throat opening is increased more than 15%.
- Hook is twisted out of plane by more than 10%.

CAUTION

Do not inspect a sling by passing bare hands over the wire rope.

OSHA 1910.184 requires wire rope slings to have "permanently affixed and legible identification markings".

BROKEN WIRES

WHAT TO LOOK FOR: The individual wires that make up the strands in a wire rope can break for various reasons including fatigue and overload. Wire rope slings must be taken out of service when you find 10 or more broken wires in one rope lay, or 5 or more broken wires in one strand of one rope lay.

TO PREVENT: Avoid pulling rope across edges or protrusions.

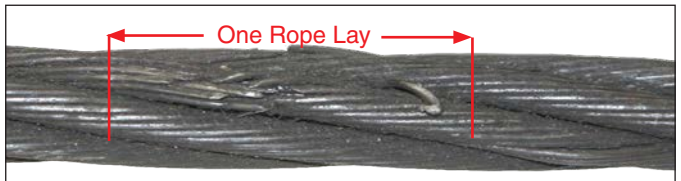

Wire
Rope

WEAR

WHAT TO LOOK FOR: Flat areas on the individual wires. When wires have lost one third or more of their original diameter, the sling must be taken out of service.

TO PREVENT: Do not drag sling on the ground and do not drag loads over slings. Protect high wear areas.



CORROSION / HEAT DAMAGE

WHAT TO LOOK FOR: Absence of lubrication and discoloration of rope.

TO PREVENT: Hang slings for storage away from moisture. Do not use wire core slings above 400° F or fiber core slings above 180° F.



KINKING / BIRDCAGING

WHAT TO LOOK FOR: Bent strands of wire or strands standing out from their regular position in the body of the sling.

TO PREVENT: Protect rope from sharp edges of load. Do not shock load slings.



CRUSHING

WHAT TO LOOK FOR: A section of rope that is flattened, where the cross section is no longer round.

TO PREVENT: Never allow loads to be set on top of slings.









SLING WEIGHTS



Estimate Sling Weights

$$\text{Sling Weight} = (\text{Length} \times \text{Per Foot Weight}) + \text{Zero Base Weight} + \text{Fitting Weights}$$

 Rope Dia. (in.)	Zero Base Weight* (lbs.)	 Per Foot Weight (lbs.)	 Thimbled Eye Wt. Ea. (lbs.)	 Alloy Eye Hook Wt. Ea. (lbs.)	 Crescent Thimble Wt. Ea. (lbs.)	 Slip Thru Thimble Wt. Ea. (lbs.)	 Sliding Choker Hook Wt. Ea. (lbs.)
1/4	0.31	0.12	0.08	0.63	0.50	1.30	1.30
5/16	0.47	0.18	0.14	0.63	0.50	1.30	1.30
3/8	0.73	0.26	0.22	0.85	0.50	1.30	1.30
7/16	1.30	0.35	0.36	1.40	0.50	1.50	1.90
1/2	1.70	0.46	0.51	1.90	0.75	1.50	1.90
9/16	3.10	0.59	0.51	3.70	0.75	1.50	1.90
5/8	3.50	0.72	0.75	3.70	1.20	3.40	4.00
3/4	5.70	1.00	1.50	7.30	2.00	3.40	4.50
7/8	8.90	1.40	1.90	15.00	3.30	5.60	10.00
1	13.00	1.90	3.00	15.00	3.80	5.60	10.00
1-1/8	18.00	2.30	4.00	22.00	5.00	8.60	26.00
1-1/4	25.00	2.90	8.20	22.00	6.80	8.60	26.00
1-3/8	32.00	3.50	12.00	38.00	8.00	10.00	50.00
1-1/2	41.00	4.20	12.00	38.00	8.00	10.00	50.00
1-3/4	65.00	5.70	18.00	60.00	17.00	18.00	-
2	99.00	7.40	25.00	105.00	22.00	53.00	-
2-1/4	169.00	9.40	40.00	148.00	39.00	70.00	-
2-1/2	278.00	12.00	-	-	39.00	126.00	-

* Zero Base Weight accounts for the additional rope and sleeves required to form two standard eyes.

Wire Rope



SLING WEIGHTS

Estimate Bridle Sling Weights

$$\text{Sling Weight} = (\text{Length} \times \text{Per Foot Weight}) + \text{Zero Base Weight}$$

Rope Dia. (in.)	2-Leg Bridle		3-Leg Bridle		4-Leg Bridle	
	*Zero Base Weight (lbs.)	Per Foot Weight (2-Legs)	*Zero Base Weight (lbs.)	Per Foot Weight (3-Legs) (lbs.)	*Zero Base Weight (lbs.)	Per Foot Weight (4-Legs) (lbs.)
1/4	2.8	0.23	2.8	.35	4.7	0.46
5/16	3.2	0.36	5.7	.54	6.9	0.72
3/8	5.8	0.52	7.5	.78	12	1.0
7/16	8.1	0.70	14	1.0	17	1.4
1/2	10	0.92	17	1.4	26	1.8
9/16	20	1.2	27	1.8	39	2.4
5/8	21	1.4	34	2.2	42	2.9
3/4	38	2.1	60	3.1	85	4.2
7/8	58	2.8	89	4.3	121	5.7
1	76	3.7	114	5.6	171	7.4
1-1/8	108	4.7	163	7.0	250	9.4
1-1/4	131	5.8	210	8.7	296	12
1-3/8	197	7.0	320	11	-	-
1-1/2	230	8.3	350	13	-	-
1-3/4	380	11.0	-	-	-	-
2	550	15.0	-	-	-	-

* Zero Base Weight includes Oblong Link, Thimbled Eyes and Sling Hooks

ACKNOWLEDGMENT

Lift-All wire rope slings and rated capacities comply with all OSHA, ASME B30.9, and Wire Rope Technical Board publications. Portions of this section of the catalog were taken from the Wire Rope Sling User's Manual with the permission of the Wire Rope Technical Board and the American Iron and Steel Institute.