

Welding & Cutting solutions from **ESAB**

Arc Equipment



Plasma Equipment



Gas Apparatus



Personal Protection



Mechanized Cutting



Welding Automation

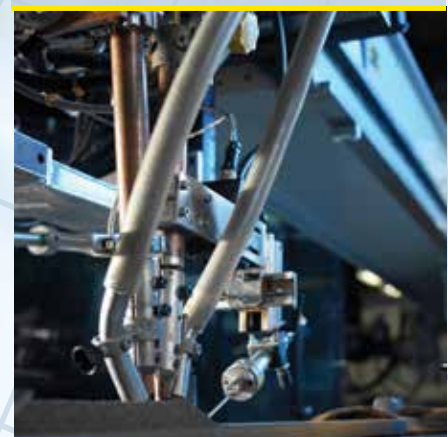

2014

A full line of arc and plasma equipment, gas apparatus, personal protection equipment, mechanized cutting, and welding automation.

ESAB Welding & Cutting Products

Equipment Catalog



Contents

Introduction	2
Arc Equipment	3
Plasma Equipment.....	77
Gas Apparatus.....	137
Personal Protection Equipment	237
Mechanized Cutting.....	261
Welding Automation	271

ESAB Welding & Cutting Products

Value & Performance Equal Confidence

ESAB delivers superior-value performance that allows today's industrial fabricator to attack any challenge with confidence.

Innovation Grounded in Experience

Our innovative, world-renowned equipment and solutions are developed with input from our customers and built with the expertise and heritage of a global manufacturing leader.

A World of Products & Solutions

ESAB's reach extends to almost every nation in the world, with **more than 8,600 employees**, an established corporate **presence in 47 countries**, and **23 manufacturing facilities** across **6 continents**.

Certified, Globally

ESAB is the first company in the world to achieve all-inclusive, external certification for the three key management standards - **ISO 9001**, **ISO 14001**, and **OHSAS 18001**. The Environmental, Health, and Safety Management System and certification covers all activities, people, and units in ESAB globally.



Serving Industries that Serve the World



Arc Equipment



SAB

WARRIOR



WARRIOR 500i CC/DC

50V
A

110V
120V
150V
180V
200V
220V
240V
250V
260V
270V
280V
290V
300V



Arc Welding Equipment

Table of Contents

Arc Welding Processes	6
Arc Welding Equipment Selection Guide	8
GMAW (MIG) Equipment, CV	
Caddy Mig C200i	10
Migmaster 215 Pro & 280 Pro	12
Origo Mig 320 & 410	14
GMAW Guns	
MXL GMAW Guns	16
MXL GMAW Gun Consumables	17
GunMaster 250 & 400	18
ST Water-Cooled GMAW Guns	20
GMAW Spool Gun Packages	22
GTAW (TIG) Equipment, CC	
Caddy Tig 2200i DC	24
Caddy Tig 2200i AC/DC	26
Heliarc 281i, 283i & 353i AC/DC	28
GTAW Torches	
TXH GTAW Torches	30
Genuine Heliarc	33
HW-24 Torch Family - 80 Amp	34
HW-90 Torch Family - 120 Amp	35
HW-9 Torch Family - 140 Amp	36
HW-17 Torch Family - 150 Amp	37
HW-26 Torch Family - 220 Amp	38
HW-20 Torch Family - 300 Amp	39
HW-18 Torch Family - 425 Amp	40
HW-25 Torch Family - 200 Amp	41
HW-27 Torch Family - 400 Amp	42
Genuine Heliarc	43
SMAW (Stick) Equipment, CC	
MiniArc 161LTS	48
Caddy Arc 201i	49
Origo Arc 410c & 650c	51
Multi-Process Equipment, CVCC	
Warrior 500i	53
Origo Mig 652c	57
Origo Mig 4002c, 5002cw & 6502c	60
Aristo Mig 5000i/U5000i	64
Aristo SuperPulse	66
MobileFeed 300AVS Wire Feeder	67
General Supplies & Accessories	
Wire Feeder Accessories	69
Counterbalance MiniBoom	71
Balanced Boom Assembly	72
Remote Controls	73
General Accessories	75

Arc Welding Processes

Gas Metal Arc Welding (GMAW, MIG)



This most flexible metal joining process involves an arc established between the workpiece and a wire electrode, which is continuously fed by a wire feeder through a torch.

The arc continuously melts the electrode to form the weld puddle.

An appropriate gas or gas mixture shields the weld area from atmospheric contamination.

The GMAW process has the advantages of high deposition rates, speed, excellent weld quality, minimal distortion of the workpiece, and no stub loss.

GMAW applications include several distinct process variations. Selection depends largely on the workpiece thickness and welding position:

Short Circuiting (Short Arc, Dip Transfer)

Involves a small fast-freezing weld puddle. Metal is transferred from the electrode to the puddle by repeated short circuits. Small diameter wires are used and the process operates at low currents and voltages. Short arc is used for welding thin gauge metals in all positions and for vertical and overhead welding of heavier sections.

Spray Arc

Electrode metal is transferred to the weld puddle as discrete droplets. Deposition rate is high and there is little or no spatter. With solid wire, the technique is used for 1/8 in. (3.2 mm) and thicker workpieces and for downhand welding.

Pulsed Spray Arc

The welding current is varied rapidly between a high and a low value. Metal is transferred to the work only during the high current period. The high peak current provides excellent arc stability. The period of low current maintains the arc and reduces the average current, making it possible to weld thinner gauge materials and to weld in all positions using larger sized wire electrodes than otherwise possible.

Cored Wire (FCAW, MCAW)

The electrode is fabricated from strip, enclosing a core of flux and metal which protects and refines the weld puddle and controls bead shape. Some cored wires can be used without external shielding gas. Smaller diameter wires can be used for all position welding. The addition of fluxing, alloy and slag-forming materials often allows high deposition rates, higher welding speeds and improved all-position capability compared with solid wires. This makes cored wire the material of choice in many high-production applications.

Shielded Metal Arc Welding (SMAW, Stick)



In this first practical arc welding process, the arc is established between a wire rod and the workpiece. The rod is coated with materials, which generate a gas and form a slag to protect the weld puddle and the solidifying weld metal from the atmosphere.

The coating may also supply alloying and refining ingredients, and the slag may help shape the weld bead, especially in vertical and overhead applications.

Electrodes are available for welding most carbon, low alloy, and stainless steels, some non-ferrous metals, and a wide range of maintenance and repair applications.

Light-duty work is often done with AC power from low cost transformers; production work usually involves DC power from heavy-duty rectifiers.

Gas Tungsten Arc Welding (GTAW, TIG)



Introduced by ESAB, the GTAW process produces welding heat from an arc between a non-consumable tungsten electrode and the workpiece. An inert gas, usually Argon, shields the arc and the workpiece.

Welding consumables, if used, are added

separately. Because the process uses totally inert shielding gas, welds of the highest quality are produced, and almost any metal can be welded.

Additional Technical Information



ESAB Technical Service Representatives are available to answer your questions. We also recommend that you take advantage of a series of handbooks published by ESAB which provide excellent guidance on the use of the arc welding processes. In addition, there are references from other sources which can be very helpful in achieving the best possible results.

Call ESAB at 1.800.ESAB.123 to find out more.

Arc Welding Processes



Icon Key

	Designates equipment capable of GMAW
	Designates equipment capable of GTAW
	Designates equipment capable of SMAW
1Phase	Designates equipment requiring 1-phase input power
3Phase	Designates equipment requiring 3-phase input power
1Phase 3Phase	Designates equipment that uses 1- or 3-phase input power
AC	Designates equipment with alternating current output
DC	Designates equipment with direct current output
ACDC	Designates equipment with alternating current & direct current output
CC	Designates equipment with constant current output
CV	Designates equipment with constant voltage output
CVCC	Designates equipment with constant current & constant voltage output

Important Product Safety

Sound common sense procedures must be followed for personal protection and operating efficiency when using arc welding equipment. Always comply with the manufacturer's recommendations for operating and maintaining the equipment, as set forth in the instructions provided with each unit. Also, be certain to use all applicable safety precautions, as described in *Precautions and Safe Practices for Arc Welding, Cutting and Gouging*, #F-52-529, which is available by contacting ESAB at 1-800-ESAB.123 or visiting esabna.com.

Arc Welding

Equipment Selection Guide

	GMAW								GTAW					SMAW			Remote Ctrl, Voltage	Remote Ctrl, Current	Submerged Arc	Arc Gouging
	Short Arc	QSet	Spray Arc	Flux Cored	Pulse Arc	SuperPulse	Inductance	Slope	DC	AC	Live TIG	Touch TIG	Pulsed TIG	High Frequency	DC	AC				
Compact Packages (built-in wire feeder)																				
Caddy Mig C200i	●	●	●	●			●													
Migmaster 215 Pro	●		●	●			●													
Migmaster 280 Pro	●		●	●			●													
Power Sources																				
Warrior 500i	●		●	●			●	●		●				●		●	●	Opt	●	
Origo Mig 320	●		●	●			●													
Origo Mig 410	●		●	●			●													
Origo Mig 652c	●		●	●			●	●		Opt				●		●	●	●	●	
Origo Mig 4002c	●	○	●	●	○	◆	●	Opt		Opt				○			●	●	Opt	
Origo Mig 5002cw	●	○	●	●	○	◆	●	Opt		Opt				○			●	●	Opt	
Origo Mig 6502c	●	○	●	●	○	◆	●	Opt		Opt				○			●	●	Opt	
Aristo Mig U5000i	●	○	●	●	○	◆	●	○			○	○	●	○		○	●	●	Opt	
Aristo Mig U5000iw	●	○	●	●	○	◆	●	○			○	○	●	○		○	●	●	Opt	
Heliarc 281i AC/DC								●	●	●	●	●	●	●	●	●	●	●	●	
Heliarc 283i AC/DC								●	●	●	●	●	●	●	●	●	●	●	●	
Heliarc 353i AC/DC								●	●	●	●	●	●	●	●	●	●	●	●	
MiniArc 161LTS								●			●			●						
Caddy Arc 201i A33								●			●			●		Auto		●		
Caddy Tig 2200i TA34								●			●	●(DC)	●	●		●		●		
Caddy Tig 2200i AC/DC								●	●	●	●	●(DC)	●	●	●	●		●		
Origo Arc 410c								●			●			●		●		●	●	
Origo Arc 650c								●			●			●		●		●	●	
Wire Feeders																				
Warrior Feed 304	●		●	●			●	●		●				●		●	●	Opt	●	
MobileFeed 300AVS	□		●	●	□															
Origo Feed 304 M12	●		●	●																
Origo Feed 304 M13u	●		●	●																
Origo Feed 3004 MA23	○		○	○			○							○		○	●	Opt		
Origo Feed 3004 MA24	○	○	○	○			○							○		○	●	Opt		
AristoFeed 3004 U6	○	○	○	○	○		○	○		○	○	○	○	○		○	●	Opt	○	
AristoFeed 3004 U8 ₂	○	○	○	○	○	○	○	○			○	○	○	○		○	●	Opt	○	

● Standard feature best performance.

□ Limited applications.

◆ Use add-on pendant.

○ When used on corresponding Aristo or Mig 4002c/5002c/6502c power sources and feeder combination.

Arc Welding Equipment Selection Guide



	Rated Output			Primary Input*		Physical				
	Rated Current' @ Duty Cycle	Welding Current Range, A	Max. WFS, ipm (m/min)	AC voltage	1 or 3 phase	Net wt., lbs. (kg)	Width, in. (cm)	Length, in. (cm)	Height, in. (cm)	
Compact Packages (built-in wire feeder)										
Caddy Mig C200i	180A @ 25%	30-200	472 (12)	230	1	26 (12)	7.8 (19.8)	17.7 (44.9)	13.7 (34.7)	
Migmaster 215 Pro	250A @ 20%	40-250	748 (19)	208/230	1	220 (100)	16.5 (42)	33.8 (86)	28.7 (73)	
Migmaster 280 Pro	250A @ 60%	40-300	750 (19)	208/230	1	341 (155)	21.7 (55)	32 (81)	34.3 (87)	
Power Sources										
Warrior 500i	500A @ 60%	16-500		380/460/575	3	115 (52)	12.8 (325)	28.1 (712)	18.5 (470)	
Origo Mig 320	320A @ 30%	40-320		230/460'	3	245 (111)	16.7 (42.5)	33 (84)	32.7 (83)	
Origo Mig 410	400A @ 50%	50-400		230/460'	3	320 (145)	21.7 (55.2)	32 (81.2)	36.4 (92.5)	
Origo Mig 652c	650A @ 60%	40-320		230/440-460	3	502 (228)	26 (64)	33 (84)	33 (84)	
Origo Mig 4002c	400A @ 60%	16-400		230/460'	3	328 (149)	25.2 (64)	32.7 (83)	32.9 (83.5)	
Origo Mig 5002cw	500A @ 60%	16-500		230/460/575	3	439 (199)	25.2 (64)	32.7 (83)	32.9 (83.5)	
Origo Mig 6502c	650A @ 60%	16-650		230/460	3	489 (222)	25.2 (64)	32.7 (83)	32.9 (83.5)	
Aristo Mig U5000i	500A @ 60%	4-500		460	3	154 (70)	15.5 (39.4)	24.6 (62.5)	19.5 (49.6)	
Aristo Mig U5000iw	500A @ 60%	4-500		460	3	198 (90)	15.5 (39.4)	24.6 (62.5)	30.6 (77.6)	
Heliarc 281i AC/DC	280A @ 50%	4-280		208-230	1	111 (50)	11.8 (300)	23.6 (600)	24.4 (620)	
Heliarc 283i AC/DC	280A @ 100%	4-280		460	3	111 (50)	11.8 (300)	23.6 (600)	24.4 (620)	
Heliarc 353i AC/DC	350A @ 45%	4-350		460	3	111 (50)	11.8 (300)	23.6 (600)	24.4 (620)	
MiniArc 161LTS	150A @ 60%	5-150		115/230	1	18 (9)	5.8 (14.6)	15.8 (40.0)	10 (25.5)	
Caddy Arc 201i A33	220A @ 20%	3-220		230	1	18.3 (8.3)	7.4 (18.8)	16.5 (41.8)	8.2 (20.8)	
Caddy Tig 2200i TA34	220A @ 20%	3-220		230	1	20.7 (9.4)	7.4 (18.8)	16.5 (41.8)	8.2 (20.8)	
Caddy Tig 2200i AC/DC	220A @ 20%	3-220		230	1	34.6 (15.7)	7.4 (18.8)	16.5 (41.8)	13.6 (34.5)	
Origo Arc 410c	400A @ 35%	20-400		230/460'	3	346 (157)	31.5 (80)	51.5 (131)	30.7 (78)	
Origo Arc 650c	650A @ 35%	20-650		230/460'	3	491 (223)	31.5 (80)	51.5 (131)	30.7 (78)	
Wire Feeders										
Warrior Feed 304	630A @ 60%		1000 (25)	42	1	33.1 (15)	10.8 (27.5)	27.2 (69)	15.5 (42)	
MobileFeed 300AVS	400A @ 100%		800 (20.3)	-		32 (14.5)	8.6 (21.7)	20.7 (52.6)	17.2 (43.7)	
Origo Feed 304 M12	630A @ 60%		1000 (25)	42	1	33.1 (15)	10.8 (27.5)	27.2 (69)	15.5 (42)	
Origo Feed 304 M13u	630A @ 60%		1000 (25)	42	1	33.1 (15)	10.8 (27.5)	27.2 (69)	16.1 (42)	
Origo Feed 3004 MA23	630A @ 60%		1000 (25)	42	1	33.1 (15)	10.8 (27.5)	27.2 (69)	15.5 (42)	
Origo Feed 3004 MA24	630A @ 60%		1000 (25)	42	1	33.1 (15)	10.8 (27.5)	27.2 (69)	15.5 (42)	
Aristo Feed 3004 U6	630A @ 60%		1000 (25)	42	1	33.1 (15)	10.8 (27.5)	27.2 (69)	15.5 (42)	
Aristo Feed 3004 U8 ₂	630A @ 60%		1000 (25)	42	1	33.1 (15)	10.8 (27.5)	27.2 (69)	15.5 (42)	

230/460/575V available in Canada.

Caddy® Mig C200i

1 Phase DC CV **3** YEAR WARRANTY **100%** EFFICIENCY

Arc
Equipment

- Easy-to-use, intelligent, and powerful inverter power source for GMAW applications with mild steels, aluminum, and stainless steel as well as GMAW brazing
- Lightweight and portable, the Caddy Mig is an excellent choice for repair, maintenance, and assembly work, both in the workshop and while on the go
- Weighing a little over 26 lbs. (12 kg), the Caddy Mig is the lightest welding unit in its output class
- Durable, impact-resistant housing made from advanced materials, including built-in cable, for easy transportation
- PFC (power factor correction) feature provides 30% more welding power from the same sized fuse
- QSet™ feature automatically sets the welding parameters and automatically adjusts during the process to maintain the optimum wire/gas combination and prevent waste of resources
- If you prefer, you can make adjustments with the wire feed speed and voltage
- A single-phase input connection makes it easy to find an electrical source and the machine performs equally as well when powered by a portable generator
- Built-in wire feeder fits a wire spool with an inner diameter of 2 in. (50 mm), external diameter of 8 in. (203 mm), and width of 2-1/8 in. (55 mm)
- Optimized to weld with .023 in. (0.6 mm), .030 in. (0.8 mm), and .035 in. (0.9 mm) solid or cored wires
- We recommend the following ESAB wires when welding with the Caddy Mig C200i:
 - Spoolarc 86, .023, .030 and .035 in. for welding of mild steels
 - Coreshield 15, .030 in. for gasless welding of mild steels
 - ERCuSi-A .030 and .035 in. for GMAW brazing
 - ESAB ER308LSi MIG .023, .030 and .035 in. for 18Cr 8Ni stainless steel welding
 - AlcoTec 5356 .035 in. for aluminum welding



Ordering Information

Ready to Weld Packages

USA

Caddy Mig C200i, 230V, 1ph..... 0558101321

Canada

Caddy Mig C200i, 230V, 1ph..... 0561000115

Includes: power source with built-in wire feeder, 10 ft. (3 m) MXL 180 torch, R-33-FM-580 regulator/flowmeter, 10 ft. (3 m) mains cable with 6-50P plug, 14.5 ft. (4.5 m) gas hose with 'B' male connector, 10 ft. (3 m) return cable with clamp, simple shoulder strap, fitted wear parts in torch/feeder (for .030 in. wire), 11 lbs. (5 kg) of 70S-6 mild steel .030 in. (0.8 mm) wire, and instruction manual.

Canada packages also include a 6-30/50P male plug.

Options & Accessories

Trolley (includes gas shelf) 0449366887
 Feedrolls, V-groove .023-.030 in. (0.6-0.8 mm)
 U-groove .040 in. (1.0 mm) 0349312836

Specifications

Caddy Mig C200i	
Input voltage	230V, 1ph, 50/60Hz
Fuse (slow)	16A
Maximum welding output	200A
Permitted load at: 25% duty cycle 100% duty cycle	180A/23V 100A/19V
Setting range	30-200A
Open circuit voltage	60V
Wire feed speed, ipm (m/min)	78-472 (2-12)
Max. size of the wire reel, in., lbs. (mm, kg)	8, 10 (200, 5)
Open circuit power	15W
Power factor at maximum current	0.99
Efficiency at maximum current	82%
Dimensions, LxWxH, in. (mm)	17.68x7.8x13.66 (449x198x347)
Weight with torch and cables, lbs. (kg)	26 (12)
Enclosure class	IP 23
Operating temperature, °F (°C)	14 to 104 (-10 to 40)

Wear Parts

Item	Description	Part Number
A	Gas nozzle	0700200054 ¹
B	Contact tip for .030 in. (0.8 mm) wire	0700200064 ¹
B	Contact tip for .035 in. (0.9 mm) wire	0700200066
C	Nozzle spring	0700200078 ¹
D	Tip adaptor	0700200072 ¹
E	Steel liner .023 - .030 in. (0.6 - 0.8 mm) wire	0700200086 ¹
E	Steel liner .035 - .045 in. (0.9 - 1.2 mm) wire	0700200088
F	Feed roller with groove	0349311890 ¹
G	Pressure roller	0349312062 ¹
H	Inlet nozzle	0455049002 ¹

¹As delivered.
See MXL 200 torch for additional nozzles, tips, and liners.

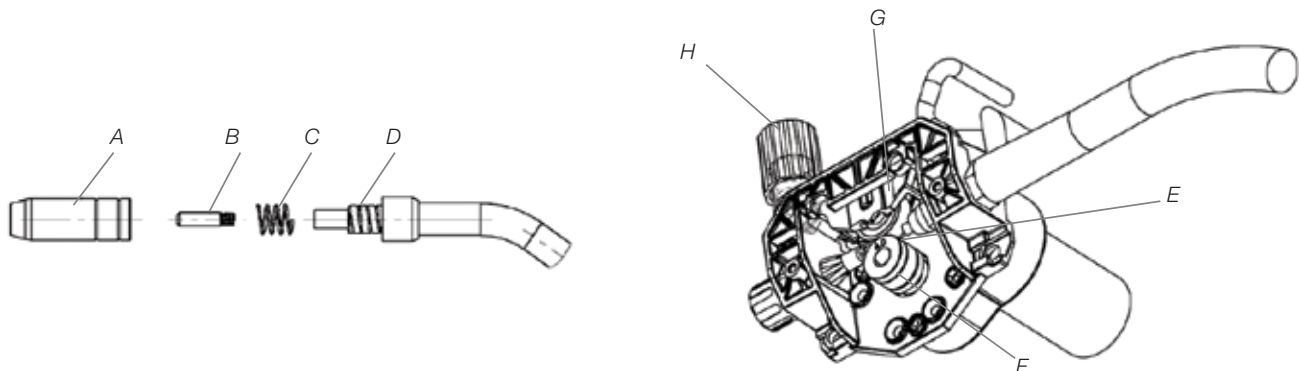

Migmaster® 215 Pro & 280 Pro

1Phase DC CV **3** YEAR WARRANTY 100% SATISFACTION GUARANTEE

- Sturdy, robust step-controlled welding power sources
- Intended for medium (215 Pro) to heavy-duty (280 Pro) GMAW applications with solid wires of steel, stainless steel, and aluminum, as well as cored wires with or without shielding gas
- ESAB's proven technology and software provide reliability and outstanding welding performance
- Made with a strong galvanized metal casing to withstand harsh environments
- Large wheels and built-in wire feeder make these machines practical, mobile solutions
- The units are fan-cooled and equipped with thermal overload protection
- A wide current and voltage range, plus two inductance outlets (280 Pro) make it easy to optimize settings for a variety of consumables and shielding gases
- Equipped with V/A digital meter with hold feature
- Equipped with the potentiometers to set the wire feed speed, spot welding time, and burnback time adjustment
- Equipped with additional functions such as creep start and inching



Ordering Information

Migmaster 215 Pro Ready to Weld Packages

208/230V, 1ph, 15 ft. (4.5 m), GM-250..... 0558101322
 208/230V, 1ph, 13 ft. (4 m), MXL 270* 0561000000

Migmaster 215 Pro Spool Gun Packages

230V, 1ph, 15 ft. (4.5 m), GM-250 MT-250SG*. 0561000001
 230V, 1ph, 13 ft. (4 m), MXL 270 MT-250SG*... 0561000002

Includes: power source with built-in wire feeder with .030-.045 in. (0.8-1.2 mm) drive roll, guide tube, 10 ft. (3 m) primary input cable with plug, gas hose, undercarriage, cylinder rack, GunMaster 250 or MXL 270 torch, 10 ft. (3 m) work cable with clamp, R-33 regulator/flowmeter, 40-lb (18-kg) spool of .035 in. (0.9 mm) solid wire.

Migmaster 280 Pro Ready to Weld Packages

208/230V, 1ph, 15 ft. (4.5 m), GM-250..... 0558101324
 208/230V, 1ph, 13 ft. (4 m), MXL 340* 0561000010
 208-575V, 1ph, 15 ft. (4.5 m), GM-250 0558101365
 208-575V, 1ph, 13 ft. (4 m), MXL 340* 0561000015

Migmaster 280 Pro Spool Gun Packages

230V, 1ph, 15 ft. (4.5 m), GM-250/MT-250SG* 0561000011
 230V, 1ph, 13 ft. (4 m), MXL 340/MT-250SG* .. 0561000012
 208-575V, 1ph, 15 ft. (4.5 m), GM-250/MT-250SG* 0561000016
 208-575V, 1ph, 13 ft. (4 m), MXL 340/MT-250SG* 0561000017

Includes: power source with built-in wire feeder with .030-.045 in. (0.8-1.2 mm) drive roll, guide tube, 10 ft. (3 m) primary input cable, gas hose, undercarriage, cylinder rack, GM-250 or MXL 340 torch, 10 ft. (3 m) work cable with clamp, and R-33 regulator/flowmeter. 230V packages include primary plug.

**Available in Canada only.*

Migmaster® 215 Pro & 280 Pro



Options & Accessories

Air Filters

Migmaster 215 Pro	0349302599
Migmaster 280 Pro	0349312810

Cable & Torch Holders

Migmaster 215 Pro	0349303362
Migmaster 280 Pro	0349312800

MT-250SG spool gun	36779
ST-23A spool gun ¹	19164

¹Requires ST-23A spool gun adaptor kit #37301.

Dual Cylinder Tray Kits

Migmaster 215 Pro	0349309312
Migmaster 280 Pro	0349312760

Feed Rolls

.023-.030 in. (0.6-0.8 mm) V-HARD.....	0367556001
.030-.040 in. (0.8-1.1 mm) V-HARD.....	0367556002
.035-.045 in. (0.9-1.2 mm) V-HARD ²	0349312497
.040-.045 in. (1.1-1.2 mm) U-SOFT.....	0367556004
.045/.052-1/16 in. (1.2/1.4-1.6 mm) VK-G.....	0367556006

²Included in ready to weld packages.

Arc
Equipment



Specifications

	Migmaster 215 Pro	Migmaster 280 Pro
Input voltage	208/230V, 1ph, 60Hz	208/230V, 1ph, 60Hz 230/460/575V, 1ph, 60Hz
Primary input current, 250A @ 25% duty cycle	53A/48A	74A/66A 66A/34A/26A
Permitted load at: 20% duty cycle 40% duty cycle 60% duty cycle 100% duty cycle	250A/23V - 160A/22V 110A/19.5V	- 300A/29V 250A/26.5V 194A/23.7V
Setting range (DC)	40A/16V-250A/23V	40A/16V-300A/29V
Power factor at maximum current	0.95	0.97
Efficiency at maximum current	76%	71%
Wire feed speed, ipm (m/min)	75-700 (2-17.8)	55-770 (1.4-19.5)
Burnback time	0-0.25 sec.	0-0.25 sec.
Spot welding time	0.2-2.5 sec.	0.2-2.5 sec.
Creep start	Selectable	Selectable
Voltage steps	12	21
Dimensions, LxWxH, in. (mm)	33x16.7x32.7 (840x425x830)	32x22x36.5 (840x552x925)
Weight, lbs. (kg)	216 (98)	308 (140)
Operating temperature, °F (°C)	14 to 104 (-10 to 40)	14 to 104 (-10 to 40)
Enclosure class	IP 23 S	IP 23 S
Wire dimensions, in. (mm): Steel Aluminum Stainless steel Cored wire	.023-.045 (0.6-1.2) .047 (1.2) .023-.045 (0.6-1.2) .035-.045/.052-1/16 (0.9-1.2/1.4/1.6)	.023-.045 (0.6-1.2) .047 (1.2) .023-.045 (0.6-1.2) .035-.045/.052-1/16 (0.9-1.2/1.4/1.6)

Origo™ Mig 320 & 410 with Origo Feed 304 M12



- Step-switched power sources for medium (320) to heavy-duty (410) GMAW applications
- Made with a strong galvanized metal casing to withstand harsh environments
- Large wheels, sturdy lifting eyelets, and an undercarriage designed for forklift transport make the Origo Mig easy to move
- The wide current and voltage range make it easy to optimize settings for a wide variety of consumables and shielding gases
- Optimized to operate together with the Origo Feed 304 M12 wire feeder available with 1.18 in. (30 mm) diameter feed rolls for wires up to 1/16 in. (1.6 mm) diameter
- Electronically controlled feeding gives an accurate and stable arc
- The wire feed unit sits on a swivel post mounted on the top of the power source, providing a 360° radius of operation
- The feeder mechanism is easy to access, and all wear parts can easily be exchanged
- A single pressure device makes it easy to adjust the appropriate feeding pressure
- All electronic components are protected in a separate compartment



Arc
Equipment

Ordering Information

Ready to Weld Packages

USA

Origo Mig 320, 230/460V, 3ph..... 0558101326
Origo Mig 410, 230/460V, 3ph..... 0558101328

Canada

Origo Mig 410, 230/460/575V, 3ph 0561000030

Includes: power source, 16 ft. (5 m) work cable/ground clamp, factory installed wheel kit, 6 ft. (1.7 m) cable connection kit, Origo Feed 304 wire feeder with M12 panel, .035/.045 in. (0.9/1.2 mm) V-groove drive rolls/guide tube, swivel mounting post for wire feeder, gas cylinder rack, 15 ft. (4.5 m) GunMaster 400cc torch with .035/.045 in. (0.9/1.2 mm) accessories and R-33-FM-580 gas regulator with adjustable flowmeter.

Basic Packages

Origo Mig 320, 230/460V, 3ph..... 0558101327
Origo Mig 410, 230/460V, 3ph..... 0558101329

Includes: power source, wire feeder, and 15 ft. (4.5 m) 400A torch.

Options & Accessories

Origo Mig 320 air filter.....	0349302599
Origo Mig 410 air filter.....	0349302423
Cable holder kit.....	0349303362
Origo MIG 320 stabilizer kit for MiniBoom.....	0349303475
Origo MIG 410 counterbalance kit for MiniBoom ¹ ..	0349305812
Reinforcer kit for mounting MiniBoom ²	0349309748

¹Includes counterbalance kit #0349309748 and stabilizer #0349303474.
²Stabilizer kit required.

Feeder Accessories

Wheel kit	0458707880
Strain relief for welding torch	0457341881
Feeder strain relief for connection cables	0459234880
Lifting eye	0458706880
Quick connector Marathon Pac	F102440880
Adapter for 11-lb (5-kg) spool	0455410001
Steel spool cover, 12 in. (305 mm)	0459431880

Counterbalance MiniBoom

For 12 in. (305 mm) spools	0458705880
For 18 in. (457 mm) spools	0458705882

Extension bracket for 60-lb coil (18 in. spools)	0459233880
Coil adaptor (requires 0459233880)	34323
Inching and gas purge kit	0459465880

Instruction Manual, Origo Mig 320	0349301158
Instruction Manual, Origo Mig 410	0349301158
Product Data Page	ARC-23283

Origo™ Mig 320 & 410

with Origo Feed 304 M12

Options & Accessories continued

Connection Cable Sets

Air-Cooled Torch, 23 Pole

5.5 ft. (1.7 m)	0349312470
16.4 ft. (5 m)	0349312471
32.8 ft. (10 m)	0349312472
49 ft. (15 m)	0349312473
82 ft. (25 m)	0349312474
115 ft. (35 m)	0349312475

Includes: control cable, electrode cable, and gas hose.

GunMaster 400cc Torches

25 ft. (7.6 m) basic	0558001674
12 ft. (3.6 m) x .035-.045 in. (0.9-1.2 mm)	0558001667
15 ft. (4.5 m) x .035-.045 in. (0.9-1.2 mm)	0558001669
15 ft. (4.5 m) x .052-1/16 in. (1.3-1.6 mm)	0558001670

See ARC-23095 for additional information.

Specifications

	Origo Mig 320	Origo Mig 410
Input voltage	230/460V, 3ph, 60Hz	230/460V, 3ph, 60Hz ¹
Permitted load at:		
30% duty cycle	320A/30V	-
50% duty cycle	-	400A/34V
60% duty cycle	250A/27V	365A/32V
100% duty cycle	195A/24V	280A/28V
Primary current at:		
30% duty cycle	34/18A	-
50% duty cycle	-	45/22A
60% duty cycle	23/12A	41/21A
100% duty cycle	16/8A	28/14A
Setting range (DC)	40A/16V-320A/30V	50A/16.5V-400A/34V
Open circuit voltage	16-40V	17-45V
Open circuit power	200W	360W
Open circuit power with cooling unit	-	600W
Power factor at maximum current	0.94	0.98
Efficiency at maximum current	75%	71%
Control voltage	42V, 50/60Hz	-
Voltage steps	40	40
Inductance outlets	2	2
Dimensions, LxW xH, in. (mm)	33x16x32 (840x425x830)	32x21x36 (812x552x925)
Weight, lbs. (kg)	244 (111)	317 (144)
Weight with cooling unit, lbs. (kg)	-	348 (158)
Operating temperature, °F (°C)	14 to 104 (-10 to 40)	14 to 104 (-10 to 40)
Enclosure class	IP 23	IP 23

¹230/460/575V available in Canada.

Origo Feed 304 M12 Wire Feeder Data

Power Supply	Wire Spool Capacity, lbs. (kg)	Max. Spool Diameter, in. (mm)	Wire Feed Speed, ipm (m/min)	Dimensions (LxWxH), in. (mm)	Weight Enclosed, lbs. (kg)	Wire Dimensions, in. (mm)	
42 VAC, 50/60 Hz	44 (19) or 60 (27) ²	12 (300) ²	31-1000 (0.8-25)	27 x11x16 (690 x 275 x 420)	33 (15)	Steel	.023-1/16 (0.6-1.6)
						Stainless steel	.023-1/16 (0.6-1.6)
						Aluminum	.040-1/16 (1.0-1.6)
						Cored wire	.030-1/16 (0.8-1.6)

¹Requires optional accessories.

²Enclosed.



MXL™ GMAW Guns



■ Designed to provide the utmost in convenience and versatility

Arc Equipment



Ordering Information

MXL 180 & 200

MXL 180, 10 ft. (3 m), .023-.030 in. (0.6-0.8 mm).. 0349483070
 MXL 200, 10 ft. (3 m), .023-.030 in. (0.6-0.8 mm).. 0700200002

MXL 270

MXL 270, 10 ft. (3 m), .035-.045 in. (0.9-1.2 mm).. 0700200004
 MXL 270, 13 ft. (4 m), .035-.045 in. (0.9-1.2 mm).. 0700200005

MXL 340

MXL 340, 13 ft. (4 m), .035-.045 in. (0.9-1.2 mm).. 0700200007

MXL torches available in Canada only.



Specifications

	MXL 180/200	MXL 270	MXL 340
Permitted load at: 35% duty cycle, CO ₂ 35% duty cycle, Ar/CO ₂	200A 170A	270A 260A	340A 320A
Cable length, ft. (m)	10 (3)	10 (3), 13 (4)	13 (4)
Weight, lbs. (kg): 10 ft. (3 m) 13 ft. (4 m)	3.5 (2) -	4.8 (2) 5.7 (3)	- 8.2 (4)



MXL™ GMAW Gun Consumables



Consumables & Wear Parts

	Size, in. (mm)	MXL 180/200	MXL 270	MXL 340
1	Gas Nozzle			
	7/16 (12), Standard	0700200054	-	-
	9/16 (15), Standard	-	0700200055	-
	5/8 (16), Standard	-	-	0700200056
	5/8 (16), Straight	0700200057	-	-
	11/16 (18), Straight	-	0700200058	-
	3/8 (9.5), Conical	0700200060	-	-
	7/16 (12), Conical	-	0700200061	-
2	Contact Tip			
	.023 (0.6)	0700200063	-	-
	.030 (0.8)	0700200064	-	-
	.035 (0.9)	0700200065	-	-
	.040 (1.0)	0700200066	-	-
	.030 (0.8)	-	0700200068	0700200068
	.035 (0.9)	-	0700200069	0700200069
	.040 (1.0)	-	0700200070	0700200070
	.045 (1.2)	-	0700200071	0700200071
3	Tip Adaptor			
	Standard	0700200072	-	-
	Standard	-	0700200073	-
	Short	-	-	0700200074
	Use with teflon liners	-	0700200067 ²	0700200075
4	Gas Diffusor	-	-	0700200080
5	Nozzle Spring	0700200078	0700200079	-
6	Liner, in. (mm)			
	Steel: .023-.030 (0.6-0.8), 13 ft. (4 m)	0700200086¹	0700200086	0700200086
	Steel: .035-.045 (0.9-1.2), 13 ft. (4 m)	0700200088 ¹	0700200088	0700200088
	Teflon: .035-.045 (0.9-1.2), 13 ft. (4 m)	0700200092 ¹	0700200092 ²	0700200092

¹MXL 180 use requires removal of wear inlet/collet.

²Use tip adaptor #0700200067 when using teflon liners.

Bold = standard deliveries.

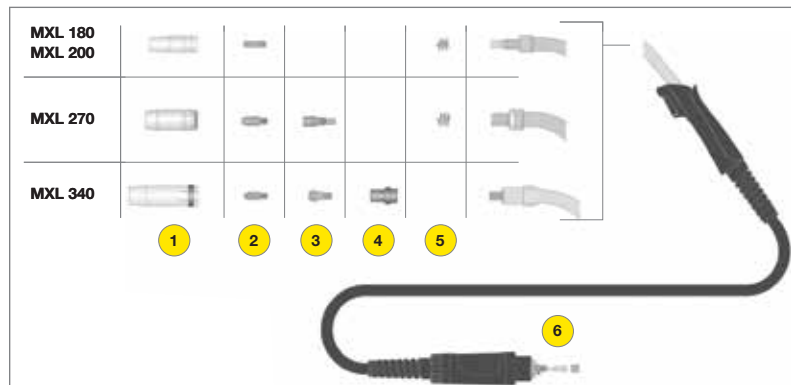

Arc
Equipment



GunMaster 250 & 400



- "Slide-on" standard and heavy-duty copper wall nozzles deliver performance and dependability
- Lightweight handle is impact resistant for long life
- Cable resists cuts, spatter, oil, and abrasion

Arc
Equipment

Ordering Information

Complete Assemblies NAS Style

GunMaster 250

10 ft. (3 m) x .023 in. (0.6 mm).....	0558001630
10 ft. (3 m) x .035-.045 in. (0.9-1.1 mm).....	0558001631
12 ft. (3.6 m) x .035-.045 in. (0.9-1.1 mm).....	0558001635
15 ft. (4.5 m) x .035-.045 in. (0.9-1.1 mm).....	0558001639

GunMaster 400

10 ft. (3 m) x .035-.045 in. (0.9-1.1 mm).....	0558001653
12 ft. (3.6 m) x .035-.045 in. (0.9-1.1 mm).....	0558001656
12 ft. (3.6 m) x .052-1/16 in. (1.3-1.6 mm).....	0558001657
15 ft. (4.5 m) x .035-.045 in. (0.9-1.1 mm).....	0558001659
15 ft. (4.5 m) x .052-1/16 in. (1.3-1.6 mm).....	0558001660

Complete Assemblies CC Style

GunMaster 250cc

10 ft. (3 m) x .035-.045 in. (0.9-1.1 mm).....	0558001644
12 ft. (3.6 m) x .035-.045 in. (0.9-1.1 mm).....	0558001645
15 ft. (4.5 m) x .035-.045 in. (0.9-1.1 mm).....	0558001649

GunMaster 400cc

12 ft. (3.6 m) x .035-.045 in. (0.9-1.1 mm).....	0558001667
15 ft. (4.5 m) x .035-.045 in. (0.9-1.1 mm).....	0558001669
15 ft. (4.5 m) x .052-1/16 in. (1.3-1.6 mm).....	0558001670

Basic NAS Style

Gun Master 400 NAS, 25 ft. (7.6 m).....	0558001664
-----------------------------------------	------------

Basic CC Style

Gun Master 400cc, 25 ft. (7.6 m).....	0558001674
---------------------------------------	------------

Options & Accessories

ESAB power pin.....	0558002313
Lincoln power pin.....	0558001862
45°, 250A gooseneck ¹	0558001616
Gas meter ²	19043
GMAW gun holder.....	0760022300

¹For GunMaster 250.

²Measures gas flow at the gun.

Trigger Leads, ESAB Style for NAS Style Guns

GunMaster 250, 6 in. (0.15 m).....	0558001815
GunMaster 250, 24 in. (0.6 m).....	0558002583
GunMaster 400.....	2075216

Control Plugs (Options)

Lincoln (LN 7, 8, 9, NAS).....	0558001864
--------------------------------	------------



Options & Accessories continued

Liner Selection

Steel/Flux Core

.023 in. (0.6 mm) x 10,12,15 ft.(3, 3.6, 4.5 m)...	0558001675
.030 in. (0.8 mm) x 10,12,15 ft. (3, 3.6, 4.5 m).....	37031
.035/.045 in. (0.9/1.1 mm) x 10,12,15 ft. (3, 3.6, 4.5 m) ..	37032
.052-1/16 in. (1.3-1.6 mm) x 10,12,15 ft. (3, 3.6, 4.5 m) ..	37033
5/64 in. (2.0 mm) x 10,12,15 ft. (3, 3.6, 4.5 m) ..	0558001676
3/32 in. (2.5 mm) x 10,12,15 ft. (3, 3.6, 4.5 m).....	37034
7/64-1/8 in. (2.8-3.2 mm) x 10,12,15 ft. (3, 3.6, 4.5 m) ..	952948
.035 - .045 in. (0.9-1.1 mm) x 25 ft. (7.6 m)	0558002137
.052 - 1/16 in. (1.3-1.6 mm) x 25 ft. (7.6 m)	0558002138
5/64 in. (2.0 mm) x 25 ft. (7.6 m).....	0558002139
3/32 in. (2.5 mm) x 25 ft. (7.6 m).....	0558002140

Aluminum

.035-3/64 in. (0.9-1.2 mm) x 15 ft. (4.5 m) poly	37039
3/64-1/16 in. (1.2-1.6 mm) x 15 ft. (4.5 m) poly	37040

Requires jumper sleeve #0558006682 when H.D. parts used.

Note: All 15 ft. (4.5 m) liners can be trimmed to fit 10 ft. (3 m) or 12 ft. (3.6 m). For use with Origo Feed MA23/MA24, and Aristo Feed U6/U8₂ Plus.

Aluminum Optimization Kits

For use with Origo Feed/Aristo Feed wire feeders

.035 in. (0.9 mm) and 3/64 in. (1.2 mm) Al.....	0558007841
3/64 in. (1.2 mm) and 1/16 in. (1.6 mm) Al.....	0558007842

Includes: 15 ft. (4.5 m) liners (CER/TFE), drive roll guides (4), tips (2 ea. size for kit), nozzle H.D. 5/8 in. (19 mm) and jumper sleeve.

Instruction Manual, GunMaster 250.....	F-15-612
Instruction Manual, GunMaster 400.....	F-16-513
Product Data Page.....	ARC-23095

GunMaster 250 & 400



Nozzles

Standard-Duty		Tip relationship using all sizes standard-duty tips 5/64 in. and 3/32 in. (2.0 and 2.5 mm)		Tip relationship using all sizes heavy duty tips except 5/64 in. and 3/32 in. (2.0 and 2.5 mm)
Inside Diameter, in. (mm)	Part Number			
3/8 (9.5)	0558001609	1/8 in. (3.2 mm) Stick Out	Copper	1/8 in. (3.2 mm) Stick Out
1/2 (12.7)	0558001612	Flush	Copper	Flush
1/2 (12.7)	0558001611	1/8 in. (3.2 mm) Stick Out	Copper	1/8 in. (3.2 mm) Stick Out
1/2 (12.7)	0558001613	1/4 in. (6.4 mm) Stick Out	Copper	1/4 in. (6.4 mm) Stick Out
5/8 (15.8)	0558001614	1/8 in. (3.2 mm) Stick Out	Copper	1/8 in. (3.2 mm) Stick Out
5/8 (15.8)	0558001615	1/4 in. (6.4 mm) Stick Out	Copper	1/4 in. (6.4 mm) Stick Out
Standard-Duty Tip/Nozzle Adaptor				
Tip/adaptor	0558001608			
Heavy-Duty		Tip relationship using 5/64 in. and 3/32 in. (2.0 and 2.5 mm) heavy-duty tips only		Tip relationship using all sizes heavy duty tips except 5/64 in. and 3/32 in. (2.0 and 2.5 mm)
Inside Diameter, in. (mm)	Part Number			
5/8 (15.8)	0558001599	1/8 in. (3.2 mm) Recess	Copper	Flush
5/8 (15.8)	0558001600	1/4 in. (6.4 mm) Recess	Copper	Flush
5/8 (15.8)	0558001598	Flush	Copper	1/8 in. (3.2 mm) Stick Out
Heavy-Duty Tip/Nozzle Adaptor				
Tip/adaptor	0558001888			

All tips are the medium length to give these relationships.

Contact Tips

Standard-Duty Tips		Heavy-Duty Tips	
Wire Size, in. (mm)	Part Number	Wire Size, in. (mm)	Part Number
.023 (0.6)	20543	.030 (0.8)	0558002367
.030 (0.8)	20544	.035 (0.9)	0558002368
.035 (0.9)	996995	.040 (1.0)	0558002369
.045 (1.1)	37290	.045 (1.1)	37286
.045 - 3/64 (1.1 - 1.2)	996999	3/64 (1.2) Aluminum	17765
.052 (1.4)	2075349	.052 (1.4)	17778
1/16 (1.6)	996997	1/16 (1.6) Hard or Cored Wire	37291
5/64 (2.0)	2075230	1/16 (1.6) Aluminum	948835
		5/64 (2.0)	948832
		3/32 (2.5)	948833

Gun Amperage Ratings

GunMaster Model	100% Duty Cycle		60% Duty Cycle	
	CO ₂	Mixed	CO ₂	Mixed
GunMaster 250	250A	180A	300A	250A
GunMaster 400	400A	275A	525A	400A

Ratings are based on tests that comply with NEMA ARC Welding Section Standard 11-6-1975 for duty cycle. "The time period of one complete cycle shall be 10 minutes" (60% = 6 minutes). National Electrical Manufacturers Association 2101 L Street N.W., Washington, D.C., 20037.



ST Water-Cooled GMAW Guns



- Rated at 600A with any shielding gas
- Handles flux cored wires to 7/64 in. (2.8 mm)
- ST-21M has an in-line body style designed for mechanized applications

Arc
Equipment



ST-21



ST-16

ST-21M

Ordering Information

ST-16, 10 ft. (3 m)	997498
ST-21, 12 ft. (3.6 m)	995950
ST-21M, 2 ft. (0.6 m)	690509

Does not include liner/conduits, contact tips/tubes or nozzles.

Options & Accessories

Warrior Feed 304 for ST-21 & ST-16	0588002048
Spatter liner	633603
Centering bushing	17782
EH-10A mech. Gun mounting bracket (ST-21M)	633885
EH-10A connection block assembly (ST-21M)	58V74
Outlet guide, .045-1/16 in. (1.2-1.6 mm)	0588000995
Power cable adaptor	45V11
Gas meter ¹	19043

¹Measures gas flow at the gun.

Specifications

	ST-16	ST-21	ST-21M
Gun capacity	600A @ 100% duty cycle	600A @ 100% duty cycle	600A @ 100% duty cycle
Dimensions, LxH, in. (mm)	13-3/4x4-1/4 (350x110)	12-1/2x7-1/16 (315x180)	10.25 (260) (length only)
Handle diameter, in. (mm)	1-3/8 (35)	1-3/8 (35)	1-3/8 (35)
Gun angle	55°	180°	180°
Weight, (less service lines), oz. (g)	28 (794)	38 (1077)	28 (794)
Cooling requirements, qt/min (L/min) ¹	1.6 (1.5)	1.6 (1.5)	1.6 (1.5)
Wires accommodated, in. (mm):			
Hard	.030-3/32 (0.8-2.4)	.030-3/32 (0.8-2.4)	.030-3/32 (0.8-2.4)
Soft	.035-3/32 (0.9-2.4)	.035-3/32 (0.9-2.4)	.035-3/32 (0.9-2.4)
Cored	.030-7/64 (0.8-2.8)	.030-7/64 (0.8-2.8)	.030-7/64 (0.8-2.8)

¹Minimum.

Instruction Manual, ST-16	F-11-744
Instruction Manual, ST-21	F-12-218
Instruction Manual, ST-21M	F-11-964
Product Data Page	ARC-23218

ST Water-Cooled GMAW Guns



Conduits & Liners for ST-16 & ST-21 Water-Cooled GMAW Guns

Wire Size, in. (mm)	Hard and Flux-Cored Wire			Aluminum		
	10 ft. (3 m) Conduit	ST-16 Jumper Liner	ST-21 Jumper Liner	10 ft. (3 m) Conduit	ST-16 Jumper Liner	ST-21 Jumper Liner
.030 (0.8)	633455	993822	-	-	-	-
.035 (0.9)	633455	993822	-	633578	636877 ¹	-
.045 (1.2)	633456	993823	995951	-	-	-
3/64 (1.2)	-	-	-	633578	636877 ¹	995953
.052 (1.4)	633456	993823	995951	-	-	-
1/16 (1.6)	633456	993823	995951	634777	636879	995953
5/64 (2.0)	598806	993823	995952	-	-	-
3/32 (2.4)	598922	598927	995952	46V68	994552	995954

¹Requires support liner #598927.

Conduits & Liners for ST-21M Water-Cooled GMAW Guns

Wire Size, in. (mm)	Hard and Flux-Cored Wire			Aluminum			Conduit Liner
	4 ft. (1.2 m)	6 ft. (2 m)	10 ft. (3 m)	4 ft. (1.2 m)	6 ft. (2 m)	10 ft. (3 m)	
.045 (1.2)	38V86	39V99	40V18	-	-	-	-
3/64 (1.2)	-	-	-	38V89	40V01	-	42V74
.052 (1.4)	38V86	39V99	40V18	-	-	-	-
1/16 (1.6)	38V86	39V99	40V18	39V80	39V83	40V20	42V75
5/64 (2.0)	38V89	40V01	-	-	-	-	-
3/32 (2.4)	39V80	39V83	40V20	39V80	39V83	40V20	42V73
7/64 (2.8)	39V80	39V83	40V20	-	-	-	-

ST-21M requires bracket #633885 and adaptor #61N59 for use with the above conduits when mounting away from feeder. Refer to torch manuals for specific accessories required to install on wire feeder (available online at esabna.com).

ST-16, 21 & 21M Contact Tips & Tubes

Wire Size, in. (mm)	Inside Diameter, in. (mm)	Contact Tips		Contact Tubes
		Short	Long	
.030 (0.8)	0.037 (0.9)	632791	-	-
.035 (0.9)	0.043 (1.1)	632793	632794	996104
.045 (1.2)	0.054 (1.4)	37278	37279	37280
3/64 (1.2)	0.058 (1.5)	-	-	996105
3/64 (1.2)	0.061 (1.6)	632795	632796	-
.052 (1.4)	0.062 (1.6)	-	-	996816
1/16 (1.6)	0.073 (1.9)	-	37282	37283
1/16 (1.6)	0.078 (2.0)	632797	632798	996106
5/64 (2.0)	0.094 (2.4)	-	-	996107
3/32 (2.4)	0.107 (2.7)	632800	-	996108
7/64 (2.8)	0.123 (3.1)	633611	-	-

ST-16, 21 & 21M Gas Nozzles

Nozzle Size	Inside Diameter, in. (mm)	ST-16/21/21M
8	1/2 (12.7)	598739 ¹
10	5/8 (15.8)	598721 ¹
10 Long	5/8 (15.8)	598891 ¹
12	3/4 (19)	633985
12 Medium	3/4 (19)	997310
12 Long	3/4 (19)	639756
12 Spot	3/4 (19)	993757

¹Requires spatter liner #633603.



GMAW Spool Gun Packages



ST-23A Spool Gun

- Rugged 250A @ 100% duty cycle performance
- Service lines enter the rear of gun instead of handle for improved balance and accessibility
- Inching push button mounted on bottom of handle
- 30 ft. (9 m) service lines
- Designed for use with Migmaster compacts
- Weighs less than 3 lbs. (1.3 kg)
- Uses durable contact tips and nozzles
- Powerful gear motor in handle pulls welding wire from 4 in. (101.5 mm) diameter spool in the molded gun case
- Partial depression of the torch trigger controls gas pre- and post-flow operations - full depression provides wire feeding as well as gas flow
- Wire feed control mounted on gun provides precise adjustment of wire feed rate at torch



ST-23A Spool Gun

MT-250 SG Spool Gun

- Designed for use with Migmaster compacts
- Weighs less than 3 lbs. (1.3 kg)
- Uses durable MT contact tips and nozzles
- Powerful gear motor in handle pulls welding wire from 4 in. (101.5 mm) diameter spool in the molded gun case
- Partial depression of the torch trigger controls gas pre- and post-flow operations - full depression provides wire feeding as well as gas flow
- Wire feed control mounted on gun provides precise adjustment of wire feed rate at torch
- Medium-duty 200A @ 100% duty performance
- Spool holder adjusts to balance in the operator's hand
- 25 ft. (7.6 m) service lines



MT-250 SG Spool Gun





GMAW Spool Gun Packages

ST-23A Spool Gun

Ordering Information

ST-23A Spool Gun 19164

Includes: one 3/64 in. (1.2 mm) contact tip, drive roll, liner, control cable, gas hose and #10 nozzle and 30 ft. (9 m) service lines.

Options & Accessories

Warrior 500i spool gun option 0588002061
 Zippered hose sheath, 25 ft. (7.6 m)¹ 35454
 ST-23A control cable extension² 636968
 ST-23A power cable/gas hose extension³ 15626
 ST-23A adaptor kit⁴ 37301

ST-23A Feed Rolls

.030-.035 in. (0.8-0.9 mm) 636343
 .045-.062 in. (1.2-1.6 mm)⁵ 996112

Torch Liners

Torch liner, .045-.062 in. (1.2-1.6 mm)⁵ 19167
 Torch liner, .030-.035 in. (0.8-0.9 mm) 19166

¹For gun service line protection.

²Extends spool gun control cable by 30 ft. (9 m).

³Includes coupling #11N19 for extending 30 ft. (9 m).

⁴For Migmaster 215 & 280 PRO.

⁵As delivered.

MT-250 SG Spool Gun

Ordering Information

MT-250 SG Spool Gun 36779

Includes: three 3/64 in. (1.2 mm) contact tips, drive roll, liner, control cable, gas hose and #10 nozzle and 25 ft. (7.6 m) service lines.

Options & Accessories

Warrior 500i spool gun option 0588002061
 Zippered hose sheath, 25 ft. (7.6 m)¹ 35454
 Gun extension lines, 25 ft. (7.6 m) 34V38
 Coupling, gas hose, 5/8-18 in. (16-457 mm) 11N17
 Replacement power/gas hose, 25 ft. (7.6 m) ... 0558002476

Quick Connectors

Male #2 - 1/0 13733936
 Female #2 - 1/0 13735632

Gas meter (measures gas flow at the gun) 19043
 Feedroll .030-3/64 in. (0.8-1.2 mm) soft wire² 36866
 Feedroll knurled .030-.045 in. (0.8-1.2 mm) hard wire 36867
 Inlet guide liner .030-3/64 in. (0.8-1.2 mm) gray 36869
 Barrel liner .030-3/64 in. (0.8-1.2 mm) white 36871

¹For gun service line protection.

²As delivered.



Nozzles

Size	Inside Diameter, in. (mm)	Standard-Duty	Heavy-Duty
6	3/8 (10)	998895	-
8	1/2 (13)	998893	-
8 HD	1/2 (13)	-	999471
10	5/8 (16)	998894	-
10 HD	5/8 (16)	-	999472 ¹
12 HD	3/4 (20)	-	999473
12 Spot	3/4 (20)	-	999625

¹Included with ST-23A and MT-250SG.

Contact Tips

Wire Size, in. (mm)	Inside Diameter, in. (mm)	Short	Contact Tips		
			Standard-Duty Medium ¹	Standard-Duty Long	Heavy-Duty Medium ²
.023 (0.6)	0.031 (0.8)	-	20543	999742	-
.030 (0.8)	0.037 (0.9)	-	20544	996994	0558002367
.030 (0.8) (Notched)	0.043 (1.1)	-	36884	-	-
.035 (0.9)	0.043 (1.1)	-	996995	996996	0558002368
.035 (0.9) (Notched)	0.048 (1.2)	-	36885	-	-
.040 (1.0)	0.048 (1.2)	-	37287	-	0558002369
.045 (1.2)	0.054 (1.4)	999578	37290	996998	37286
3/64 (1.2) (Notched)	0.060 (1.5)	-	36886 ³	-	-
3/64 (1.2)	0.058 (1.5)	-	996999 ⁴	-	17765

¹Requires tip adaptor #17983.

²Requires tip adaptor #17984.

³Included with MT-250SG.

⁴Included with ST-23A.

Instruction Manual, ST-23A F-14-353
 Instruction Manual, MT-250SG F-15-380
 Product Data Page ARC-23066

Caddy™ Tig 2200i DC

1Phase DC CC **3** YEAR WARRANTY **100%** SATISFACTION GUARANTEE

- Fifth generation Caddy machines feature advanced inverter technology built-in delivering unparalleled performance in a rugged, portable package
- Designed for quality GTAW applications with a variety of metals
- Extremely easy to use - all welding parameters displayed in an easy-to-understand format
- The TA34, 2-program function panel allows pre-programming and program changes during welding
- The TA34 panel also includes dual memory settings, switchable from the panel or torch trigger, and the capacity to set slope up/down and post-gas
- Pulsed TIG feature for greater control of heat input and weld pool
- Micro Pulse minimizes the heat affected zone, particularly when working with thin metals
- ArcPlus II improves welding characteristics and simplifies work for better weld quality with less clean up
- Hot Start and Arc Force settings create true SMAW characteristics
- Equipped with large OKC50 cable connectors for greater durability
- Compact design with impact resistant polymer and aluminum casing makes this unit lightweight and easy to carry
- Large heat sinks and innovative design make these Caddy machines run cooler for longer machine life even when used in harsh environments
- Designed to keep sensitive interior parts clean and dust free
- Built in accordance with IP 23 for outdoor use, even in wet weather conditions making Caddy Tig ideal for on-site work
- Equipped with a PFC (Power Factor Correction) circuit to allow the machine to perform a full range of functions on a 16A fuse, protects against fluctuating input voltage, and makes it safer to use with a generator
- Caddy Tig supplies direct current and allows you to weld most metals including alloy and non alloy steel, stainless steel and cast iron
- Caddy Tig welds electrodes up to 5/32 in. (4 mm) diameter



Ordering Information

Caddy Tig 2200i DC, 230V, 1ph 0460450883

Includes: power supply, TXH-201 torch 13 ft. (4 m) w/ remote on/off contactor, "crocodile" type electrode holder with 10 ft. (3 m) cable, GTAW accessory kit, R-33 regulator/flowmeter, 5 ft. (1.5 m) gas hose, 10 ft. (3 m) work cable and ground clamp, and 10 ft. (3 m) primary cable with plug.

Options & Accessories

Shoulder strap 0460265003

2-Wheel Trolley

Small gas bottle 0459366885
 Gas bottle on side 0460330880

Remote Controls

AT 1 CAN 0459491883
 AT1 CoarseFine CAN 0459491884
 MTA1 CAN 0459491880
 Foot pedal T1 CAN, with 16.4 ft. (5 m) cable ... 0460315880

Connection Cables for Remote Controls

16.4 ft. (5 m) CAN 0459554880
 33 ft. (10 m) CAN 0459554881
 49 ft. (15 m) CAN 0459554882
 82 ft. (25 m) CAN 0459554883

GTAW Torches

TXH-201, 13 ft. (4 m), OKC50 0700300552
 TXH-201F, 13 ft. (4 m), OKC50 0700300545
 TXH-201r, 13 ft. (4 m), OKC50 0700300628
 TXH-201Fr, 13 ft. (4 m), OKC50 0700300629

Electrode holder screw-type 150A, 10 ft. (3 m) 0700006898
 Electrode holder screw-type 200A, 10 ft. (3 m) 0700006900
 Return cable 150A, 10 ft. (3 m) 0700006899
 Return cable 200A, 10 ft. (3 m) 0700006901
 Remote adaptor kit¹ 0459491912
 GTAW torch holder 0760022400
 GTAW accessory kit 999126

¹Includes holder for remote models.

Instruction Manual 0460443101
 Product Data Page ARC-23252



Caddy™ Tig 2200i DC



Specifications

Caddy Tig 2200i	
Input voltage	230V, 1ph, 50/60Hz
Fuse (slow), A	16
Recommended generator size, kVA	12
Permitted load at (GTAW): 25% duty cycle 60% duty cycle 100% duty cycle	220A/18.8V 150A/16V 110A/14.4V
Permitted load at (SMAW): 25% duty cycle, 60% duty cycle 100% duty cycle	170A/26.8V 130A/25.2V 110A/24.4V
Setting range A, DC: GTAW SMAW	3-220 4-170
Open circuit voltage, V	72 V
Power factor at max. current, GTAW/SMAW	0.99
Efficiency at max. current: GTAW SMAW	5% 81%
Dimensions, LxWxH, in. (mm)	16.46x7.40x8.19 (418x188x208)
Weight, lbs. (kg)	20.72 (9)
Enclosure class	IP 23

Arc
Equipment



Control Panel Specifications

TA34 Control Panel	
Slope up, sec	0-10
Slope down, sec	0-10
Gas pre-flow, sec ¹	0-5
Gas post-flow, sec	0-25
Pulse, background time, sec	0.01-2.5
Micro Pulse time, sec ¹	0.001-0.250
Frequency AC, Hz	10-152
AC balance, %	50-98

¹Hidden functions.

Caddy™ Tig 2200i AC/DC

1Phase DC CC 3 YEAR WARRANTY 100% DUTY CYCLE

- Unparalleled performance in a mobile machine for a wide range of GTAW (TIG) and SMAW (Stick) applications
- Designed for quality GTAW applications with all types of metals
- Extremely easy to use - all welding parameters displayed in an easy-to-understand format
- Innovative QWave™ feature enables AC welding with exceptional arc stability and low noise
- AC frequency and balance control optimizes weld pool
- Electrode preheating facilitates excellent starts and extends electrode life
- The TA34, 2-program function panel allows pre-programming and program changes during welding
- AC Balance to control arc cleaning and penetration, AC Frequency to control arc width, and a special setting to control electrode preheating for better starts with a variety of electrodes
- DC Pulsed TIG welding for easy control of heat input and weld pool
- Micro Pulse minimizes the heat affected zone, particularly when working with thin metals
- Hot Start, Arc Force and polarity switch (DC) creates true SMAW characteristics in AC and DC mode
- Equipped with large OKC50 cable connectors for greater durability
- Features compact design with impact resistant polymer and aluminum casing – makes the unit lightweight and easy to carry
- Small size does not compromise vital cooling of internal components
- Large heat sinks and innovative design make these Caddy machines run cooler - promotes longer machine life even when used in harsh environments
- Designed to keep sensitive interior parts clean and dust free
- Built in accordance with IP 23 for outdoor use, even in wet weather conditions - makes this machine ideal for on-site work
- Equipped with a PFC (Power Factor Correction) circuit - allows the machine to perform a full range of functions on a 16A fuse, protects against fluctuating input voltage, and makes it safer to use with a generator



Ordering Information

Caddy Tig 2200i AC/DC, standard..... 0460150883

Includes: power supply, TXH-201 torch 13 ft. (4 m) w/remote on/off contactor, electrode holder with 10 ft. (3 m) cable, GTAW accessory kit, regulator/flowmeter, 7 ft. (2 m) gas hose, 15 ft. (4.5 m) work cable and ground clamp, and 10 ft. (3 m) primary cable with plug.

Caddy Tig 2200iw AC/DC with water cooler ... 0460150884

Includes: 10 ft. (3 m) of mains cable, no plug, 5 ft. (1.5 m) of gas hose with 2 hose clamps, 10 ft. (3 m) return cable with work clamp, SMAW kit, 2-wheel trolley, and CoolMini water cooler.

Caddy Tig 2200i AC/DC with finger control* ... 0561000125

Includes: power supply, RA T1 remote adaptor, TXH-201r torch 13 ft. (4 m) w/remote on/off contactor and variable current control, electrode holder w/10 ft. (3 m) cable, GTAW accessory kit, regulator/flowmeter, 7 ft. (2 m) gas hose, 15 ft. (4.5 m) work cable and ground clamp, and 10 ft. (3 m) primary cable with plug.

Caddy Tig 2200i AC/DC with foot control* 0561000126

Includes: power supply, TXH-201 torch 13 ft. (4 m) w/remote off/on contactor, T1-CAN foot control with 16.4 ft. (5 m) cable, electrode holder with 10 ft. (3 m) cable, GTAW accessory kit, regulator/flowmeter, 7 ft. (2 m) gas hose, 15 ft. (4.5 m) work cable and ground clamp, and 10 ft. (3 m) primary cable with plug.

**Available in Canada only.*

Caddy™ Tig 2200i AC/DC



Options & Accessories

CoolMini cooling unit 0460144880

2-Wheel Trolley

Small gas bottle 0459366885

Gas bottle on side 0460330880

Remote Controls

AT1-CAN 0459491883

AT1 CoarseFine CAN 0459491884

MTA1 CAN 0459491880

T1Foot CAN, 16.4 ft. (5 m) cable 0460315880

Connection Cables for Remote Controls

16.4 ft. (5 m) 0459554880

33 ft. (10 m) 0459554881

49 ft. (15 m) 0459554882

82 ft. (25 m) 0459554883

GTAW Torches

TXH-201, 13 ft. (4 m) OKC50 0700300552

TXH-201V, 13 ft. (4 m) OKC50 0700300553

TXH-201F, 13 ft. (4 m) OKC50 0700300554

TXH-251w, 13 ft. (4 m) OKC50 0700300561

TXH-251wF, 13 ft. (4 m) OKC50 0700300562

TXH-251w, 26 ft. (8 m) OKC50 0700300563

TXH-251wF, 26 ft. (8 m) OKC50 0700300564

F = Flexible. V = Gas Valve.

Remote adaptor RA T1, 82 ft. (25 m) cable 0459491912

GTAW torch holder 0760022400

Electrode holder screw-type 150A, 10 ft. (3 m) 0700006898

Electrode holder screw-type 200A, 10 ft. (3 m) 0700006900

Return cable 150A, 10 ft. (3 m) 0700006899

Return cable 200A, 10 ft. (3 m) 0700006901

Shoulder strap, padded 0460265003



Specifications

Caddy Tig 2200i AC/DC	
Input voltage	230V, 1ph, 50/60Hz
Fuse (slow), A	16
Permitted load at: 20% duty cycle 60% duty cycle 100% duty cycle	220A/18.8V 150A/16V 140A/15.6V
Setting range: GTAW SMAW	3-220A 4-160A
Open circuit voltage, V DC	70V
Power factor at 100%, GTAW	0.99
Efficiency at 100%, GTAW	66%
Enclosure class	IP 23
Dimensions, LxWxH, in. (mm)	16.5x7.4x13.6 (418x188x345)
Weight, lbs. (kg)	33 (15)
CoolMini Water Cooling Unit	
Cooling capacity, W	700W/0.264 g.p.m. at 104°F (700W/1 l.p.m. at 40°C)
Coolant volume, gal. (L)	0.581 (2.2)
Maximum flow, gal/min (L/min)	0.528 (2.0)
Maximum pressure, 50/60Hz, psi (bar)	33.4 (2.3)
Weight, lbs. (kg)	10/15 (4.5/6.7)
Dimensions, LxWxH, in. (mm)	16.5x7.4x5.4 (418x188x137)
TA34 Control Panel	
Slope up/down, sec	0-10
Gas pre-flow, sec ¹	0-5
Gas post-flow, sec	0-25
Pulse, background time, DC, sec	0.01-2.5
MicroPulse, sec ¹	0.001-0.250
Frequency AC, Hz	10-152
AC balance, %	50-98

¹Hidden functions.

Heliarc® 281i, 283i & 353i AC/DC

1Phase 3Phase ACDC 3 YEAR WARRANTY 100% EFFICIENCY

- Designed for quality GTAW and SMAW applications in all types of material
- Cost effective inverter technology at an SCR price - increased energy efficiency and more power from a lighter, smaller, and more portable unit
- Easy-to-control arc heat input for high quality welds
- Intuitive interface for easy setup and adjustment
- Digital controls ensure high accuracy and repeatability
- AC or DC Pulsed TIG welding - easy control of heat input and weld pool
- AC Hot Start is available at currents below 130A to boost current at the initial start to improve weld puddle initiation and arc penetration
- Control the arc with remote or foot control - switch between two currents by pressing torch switch
- Live TIG is ideal in places where high-frequency (HF) is not allowed
- AC Pulsing up to 2Hz makes Heliarc ideal for welding thin aluminum material
- Easily store up to 60 parameter sets for quick changes while working



Arc Equipment



Ordering Information

Ready to Weld Packages - Air-Cooled

Heliarc 281i, 208-230V, 1ph, TXH 151F DLX ... 0558101706
 Heliarc 281i, 208-230V, 1ph, TXH 201F DLX ... 0558101707
 Heliarc 283i, 460V, 3ph, TXH 151F DLX* 0558101715
 Heliarc 283i, 460V, 3ph, TXH 201F DLX* 0558101716

Ready to Weld Packages - Water-Cooled

Heliarc 281i, 208-230V, 1ph, TXH 251 wF DLX 0558101708
 Heliarc 281i, 208-230V, 1ph, TXH 401w DLX... 0558101709
 Heliarc 283i, 460V, 3ph, TXH 251wF DLX* 0558101717
 Heliarc 283i, 460V, 3ph, TXH 401w DLX* 0558101718
 Heliarc 353i, 460V, 3ph, TXH 251wF DLX 0558101710
 Heliarc 353i, 460V, 3ph, TXH 401w DLX 0558101711

Includes: power source, 25 ft. (7.6 m) torch, foot control, work cable, regulator/flowmeter Ar/CO₂, and cart.

Basic Packages - Water-Cooled

Heliarc 281i, 208-230V, 1ph 0558101704
 Heliarc 283i, 460V, 3ph* 0558101719
 Heliarc 353i, 460V, 3ph 0558101705

Basic package includes: power source, cooler, 2x-cable plugs, and coolant.

Power Source Only

Heliarc 281i, 208-230V, 1ph 0558101696
 Heliarc 283i, 460V, 3ph* 0558101713
 Heliarc 353i, 460V, 3ph 0558101697

**Available in USA only.*

Options & Accessories

Water cooler module..... 0558101703
 Coolant, 1 gal. (3.8 L) 0560950312
 Cart kit¹ 0558101702
 Foot control FC-5C, 30 ft. (9 m)..... 0558004234
 Electrode holder, 175A, 15 ft. (4.5 m)..... 0558001791
 Electrode holder, 300A, 15 ft. (4.5 m)..... 21226
 Quick connect "T", 1 male/2 female fittings 0365557001
 Quick lock connector male, 1/0 to 2/0 cable ... 0160360881
 Quick lock connector female, 1/0 to 2/0 cable ... 13735632
 Quick lock connector male, 1/0 to 4/0 cable ... 0160360882
 Quick lock connector female, 1/0 to 4/0 cable 13735631
 Work cable clamp and QD, 15 ft. (4.5 m) 36253
 Work cable clamp and QD, 32 ft. (9.8 m) 0588001906

¹Required with water cooler module #0558101703.

GTAW Torches

TXH-151F, 26 ft. (8 m), OKC50 0700300547
 TXH-201F, 26 ft. (8 m), OKC50 0700300557
 TXH-251wF, 26 ft. (8 m), OKC50 0700300564
 TXH-401w, 26 ft. (8 m), OKC50 0700300567
 TXH151, 26 ft. (8 m), wheel remote 0700300657
 TXH201, 26 ft. (8 m), wheel remote 0700300658
 TXH251w, 26 ft. (8 m), wheel remote 0700300659
 TXH401w, 26 ft. (8 m), wheel remote 0700300660
 TXH151, 26 ft. (8 m), flex wheel remote 0700300661
 TXH201, 26 ft. (8 m), flex wheel remote 0700300662
 TXH251w, 26 ft. (8 m), flex wheel remote 0700300663

F = Flexible.

GTAW Accessory Kits

TXH-151/201 999126
 TXH-251w 999127
 TXH-401w 0558101886

Instruction Manual 0558012079
 Product Data Page ARC-23305

Heliarc® 281i, 283i & 353i AC/DC



Control Panel



Specifications

	Heliarc 281i AC/DC	Heliarc 283i AC/DC	Heliarc 353i AC/DC
Input voltage	208-230V, 1ph, 50/60Hz	460V, 3ph, 50/60Hz	460V, 3ph, 50/60Hz
Open circuit voltage	75	75	75
Setting range, GTAW AC/DC	4-280A	4-280A	4-350A
Amps input at rated load, GTAW	47A	16.6A	16.6A
Amps input at 250A, GTAW	38A	12.5A	12.5A
Permitted load, GTAW AC/DC, at:			
100% duty cycle	250A	280A	280A
60% duty cycle	270A	-	300A
50% duty cycle	280A	-	-
45% duty cycle	-	-	350A
Power factor at maximum current, GTAW	0.80	0.75	0.80
KVA max, GTAW	10.5	11	14.5
Gas pre-flow, sec	0.1-2.5	0.1-2.5	0.1-2.5
Gas post-flow, sec	0.1-30	0.1-30	0.1-30
Slope down, sec	0.1-10	0.1-10	0.1-10
Frequency AC	20-200Hz	20-200Hz	20-200Hz
AC balance, %	10-90	10-90	10-90
DC pulse mode frequency	0.4-300Hz	0.4-300Hz	0.4-300Hz
AC pulse mode frequency	0.4-2Hz	0.4-2Hz	0.4-2Hz
Pulse duty (pulse time/background time), %	30-65	30-65	30-65
Background current % of main, A	10-90	10-90	10-90
Slope down time, sec	0.1-10	0.1-10	0.1-10
Start/crater current (4 stroke) % of main, A	10-90	10-90	10-90
Setting range, SMAW AC/DC	4-250	4-280	4-350
Permitted load, SMAW AC/DC, at:			
100% duty cycle	200A	220A	220A
60% duty cycle	220A	240A	240A
40% duty cycle	250A	280A	-
20% duty cycle	-	-	350A
KVA max, SMAW	12	14.2	19
Dimensions, LxWxH, in. (mm)	23.6x11.8x24.4 (600x300x620)	23.6x11.8x24.4 (600x300x620)	23.6x11.8x24.4 (600x300x620)
Weight, lbs. (kg)	110 (50)	110 (50)	110 (50)
Enclosure class	IP 21S	IP 21S	IP 21S

TXH™ GTAW Torches

TXH-121, 151, 201, 251 & 401



- TXH torches are designed to provide the utmost in convenience, versatility, and ergonomics to the welder
- Choose between air-cooled and water-cooled versions, with or without gas valve, and with or without a flexible neck to suit specific applications
- The torch heads are manufactured with high temperature resistant silicone rubber insulation
- All copper components ensure cooler running temperatures and maximum current capacity
- Integrated dual soft grips ensure the handle remains in place with minimal grip pressure
- Positioning of the torch is made easier by the combination of knuckle joints and a flexible leather section covering the first 31.5 in. (800 mm) of the torch immediately behind the handle



Air-Cooled Torches

OKC25 Connector [1 in. (25 mm)]

TXH-121

TXH-121, 13 ft. (4 m)'	0700300522
TXH-121, 13 ft. (4 m)	0700300532
TXH-121, 26 ft. (8 m)'	0700300527
TXH-121, 26 ft. (8 m)	0700300534
TXH-121V, 13 ft. (4 m)	0700300523
TXH-121V, 26 ft. (8 m)	0700300528
TXH-121F, 13 ft. (4 m)	0700300525
TXH-121F, 26 ft. (8 m)	0700300530

TXH-151

TXH-151, 13 ft. (4 m)'	0700300538
TXH-151, 13 ft. (4 m)	0700300548
TXH-151, 26 ft. (8 m)	0700300550
TXH-151, 26 ft. (8 m)'	0700300542
TXH-151V, 13 ft. (4 m)	0700300537
TXH-151V, 26 ft. (8 m)	0700300543
TXH-151F, 13 ft. (4 m)	0700300540
TXH-151F, 26 ft. (8 m)	0700300546

¹OKC25C.

TXH-201

TXH-201, 13 ft. (4 m)	0700300588
TXH-201, 26 ft. (8 m)	0700300560
TXH-201F, 13 ft. (4 m)	0700300599

OKC50 Connector [2 in. (50 mm)]

TXH-121

TXH-121, 13 ft. (4 m)	0700300524
TXH-121, 26 ft. (8 m)	0700300529
TXH-121F, 13 ft. (4 m)	0700300526
TXH-121F, 26 ft. (8 m)	0700300531

OKC50 Connector [2 in. (50 mm)] continued

TXH-151

TXH-151, 13 ft. (4 m)	0700300538
TXH-151, 26 ft. (8 m)	0700300544
TXH-151V, 13 ft. (4 m)	0700300539
TXH-151V, 26 ft. (8 m)	0700300545
TXH-151F, 13 ft. (4 m)	0700300541
TXH-151F, 26 ft. (8 m)	0700300547

TXH-201

TXH-201, 13 ft. (4 m)	0700300552
TXH-201, 26 ft. (8 m)	0700300555
TXH-201V, 13 ft. (4 m)	0700300553
TXH-201V, 26 ft. (8 m)	0700300556
TXH-201F, 13 ft. (4 m)	0700300554
TXH-201F, 26 ft. (8 m)	0700300557

Water-Cooled Torches

OKC50 Connector [2 in. (50 mm)]

TXH-251

TXH-251w, 13 ft. (4 m)	0700300561
TXH-251w, 26 ft. (8 m)	0700300563
TXH-251wF, 13 ft. (4 m)	0700300562
TXH-251wF, 26 ft. (8 m)	0700300564

TXH-401

TXH-401w, 13 ft. (4 m)	0700300565
TXH-401w, 26 ft. (8 m)	0700300567
TXH-401w HD, 13 ft. (4 m)	0700300566
TXH-401w HD, 26 ft. (8 m)	0700300568

F = Flexible. V = Gas Valve.

TXH™ GTAW Torches

TXH-121, 151, 201, 251 & 401

Remote Control Torches

OKC50 Connector [2 in. (50 mm)]

TXH-121

TXH-121r, 13 ft. (4 m)	0700300620
TXH-121r, 26 ft. (8 m)	0700300622
TXH-121Fr, 13 ft. (4 m)	0700300621

TXH-151

TXH-151r, 13 ft. (4 m)	0700300624
TXH-151r, 26 ft. (8 m)	0700300626
TXH-151Fr, 13 ft. (4 m)	0700300625
TXH-151Fr, 26 ft. (8 m)	0700300627

TXH-201

TXH-201r, 13 ft. (4 m)	0700300628
TXH-201r, 26 ft. (8 m)	0700300630
TXH-201Fr, 13 ft. (4 m)	0700300629
TXH-201Fr, 26 ft. (8 m)	0700300631

TXH-251

TXH-251wr, 13 ft. (4 m)	0700300632
TXH-251wr, 26 ft. (8 m)	0700300634
TXH-251wFr, 13 ft. (4 m)	0700300633
TXH-251wFr, 26 ft. (8 m)	0700300635

TXH-401

TXH-401wr, 13 ft. (4 m)	0700300636
TXH-401wr, 26 ft. (8 m)	0700300638
TXH-401wr HD, 13 ft. (4 m)	0700300637
TXH-401wr HD, 26 ft. (8 m)	0700300639

F = Flexible. V = Gas Valve.

Arc
Equipment



Specifications

	TXH-121	TXH-151	TXH-201	TXH-251w	TXH-401w	TXH-401w HD
Permitted load at:						
35% duty cycle	-	150A	200A	-	400A	430A
60% duty cycle	120A	120A	150A	250A	350A	400A
100% duty cycle	100A	100A	140A	200A	300A	-
◀ Ø in. (mm)	.040-1/8 (1.0-3.2)	.040-1/8 (1.0-3.2)	.040-5/32 (1.0-4.0)	.040-1/8 (1.0-3.2)	.040-3/16 (1.0-4.8)	.040-3/16 (1.0-4.8)

See Wear Parts table on next page.

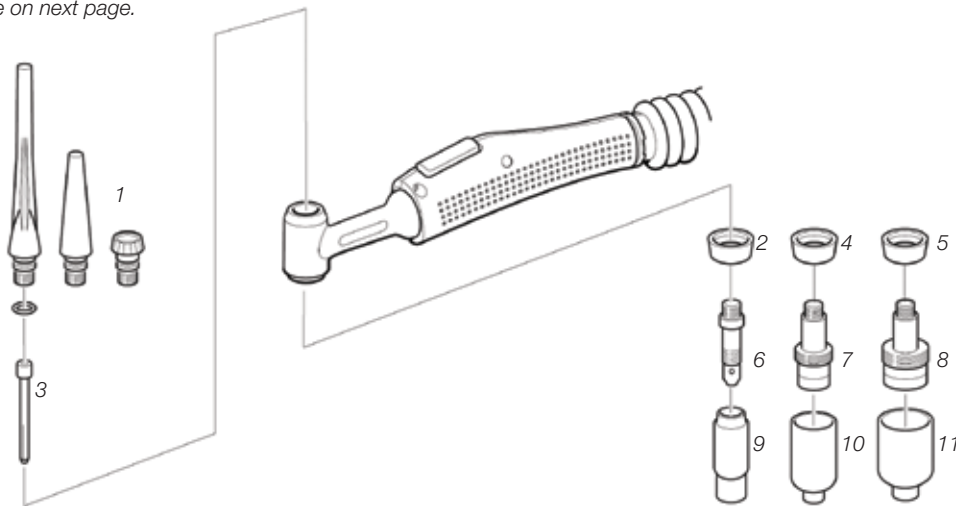

TXH™ GTAW Torches

TXH-121, 151, 201, 251 & 401

Wear Parts



	Description	Size, in. (mm)	TXH-121/251w	TXH-151/201	TXH-401w/401wHD
1	Back cap	Long Medium Short	0365310051 ¹ 0365310050 0365310049 ¹	0157123029 ¹ 0588000591 0157123028	0157123029 ¹ 0588000591 0157120028
2	Heat shield		0366960017	0366960016 ¹	0366960018 ¹
4	Heat shield		-	0366960020	-
5	Heat shield (XL gas lens)		-	0366960021	-
3	Collet std & gas lens	Ø .040 (1.0) Ø 1/16 (1.6) Ø 3/32 (2.4) Ø 1/8 (3.2) Ø 5/32 (4.0)	0365310028 0365310029 0365310030 ¹ 0365310091 -	0157123010 0157123011 0157123012 ¹ 0157123013 0157123014	0157123010 0157123011 - - -
6	Collet body, heavy-duty	Ø 3/32 (2.4) Ø 1/8 (3.2) Ø 5/32 (4.0) Ø 3/16 (4.8)	- - - -	- - - -	0157123077 ¹ 0157123078 0157123079 0157123074
7	Collet body, standard	Ø .040 (1.0) Ø 1/16 (1.6) Ø 3/32 (2.4) Ø 1/8 (3.2) Ø 5/32-3/16 (4.0-4.8) Ø .023-3/32 (0.5-2.4) Ø 1/8-3/16 (3.2-4.0)	0365310037 0365310038 0365310039 ¹ 0365310090 - - -	0157123015 0157123016 0157123017 ¹ 0157123018 0157123019 - -	- - - - - 0157123081 ¹ 0157123082
8	Collet body w/gas lens	Ø .040 (1.0) Ø 1/16 (1.6) Ø 3/32 (2.4) Ø 1/8 (3.2) Ø 5/32 (4.0) Ø 3/16 (4.8)	0157121016 0157121017 0157121018 0157121041 - -	0157123021 0157123022 0157123023 0157123024 0157123025 -	0157123091 0157123092 0157123093 0157123094 0157123095 0157123075
9	Collet body w/XL gas lens	Ø .040 (1.0) Ø 1/16 (1.6) Ø 3/32 (2.4) Ø 1/8 (3.2) Ø 5/32-3/16 (4.0-4.8)	- - - - -	0157123083 0157123084 0157123085 0157123086 0157123087	- - - - -
10	Gas nozzles, standard	Ø 1/4 (6.4) Ø 0.35 (8.0) Ø 0.36 (9.8) Ø 0.44 (11.2) Ø 1/2 (12.7) Ø 1/8 (15.9) Ø 3/4 (19.0)	0365310044 0365310045 0365310046 ¹ 0365310047 0365310048 0588000440 -	0157123052 0157123053 0157123054 0157123055 ¹ 0157123056 0588000442 0588000441	- - - - - - -
11	Gas nozzles for gas lens	Ø 1/4 (6.4) Ø 0.35 (8.0) Ø 0.36 (9.8) Ø 0.44 (11.2) Ø 1/2 (12.7) Ø 0.7 (17.5)	0157121032 0157121033 0157121034 0157121039 0157121040 -	0157123057 0157123058 0157123059 0157123060 0157123061 0588000439	0157123057 0157123058 0157123059 0157123060 0157123061 ¹ -
	XL gas nozzle for XL gas lens	Ø 0.36 (9.8) Ø 1/2 (12.7) Ø 1/8 (15.9) Ø 3/4 (19.0) Ø 0.94 (24.0)	- - - - -	0157123088 0157123089 0588000438 0157123098 0588000437	- - - - -

¹Standard delivery.

Genuine Heliarc® GTAW Torch Selection Guide



Gas-Cooled Torches

Description	Rating @ 50% Duty Cycle	Hard Body ¹ w/HFC	Silicon Rubber ²	60° Head Angle	70/75° Head Angle	90° Head Angle	180° Head Angle	Flex Head	With Valve	Without Valve	Comments
HW-24	80A	•		•		•				•	Miniature, ultra light torch
HW-90	120A	•			•		•			•	Small, lightweight torch
HW-9	140A	•			•					•	Compact, air-cooled version of HW-20
HW-9RV-2	140A		•		•				•		Separate power cable/gas hose
HW-9RV	140A		•		•				•		Rotary valve
HW-9F	140A		•					•		•	Flexible head version of HW-20A
HW-17	150A	•		•		•			•	•	Rotary valve/sliding valve available
HW-17-2	150A	•		•					•	•	Separate power cable/gas hose
HW-17R	150A		•	•		•			•	•	Rotary valve available
HW-17R-2	150A		•	•					•	•	Separate power cable/gas hose
HW-17F	150A		•					•	•	•	Flexible head version
HW-17F-2	150A		•					•	•	•	Separate power cable/gas hose
HW-26	220A	•			•				•	•	Popular heavy-duty, air-cooled torch
HW-26-2	220A	•			•				•	•	Separate power cable/gas hose
HW-26R	220A		•		•				•	•	Concentric power cable
HW-26R-2	220A		•		•				•	•	Separate power cable/gas hose
HW-26F	220A		•					•	•	•	Flexible head version
HW-26F-2	220A		•					•	•		Separate power cable/gas hose

Arc
Equipment



Water-Cooled Torches

Description	Rating@ 50% Duty Cycle	Hard Body ¹ w/HFC	Silicon Rubber ²	60° Head Angle	70/75° Head Angle	90° Head Angle	180° Head Angle	Flex Head	With Valve	Without Valve	Comments
HW-20	300A	•			•					•	Compact, high current torch
HW-20R	300A		•		•					•	Compact, high current torch
HW-18	425A	•		•		•				•	General purpose
HW-18R	425A		•	•						•	General purpose
HW-25F	200A		•				•	•		•	Flexible head, water torch
HW-27	400A	•					•			•	Rear loading machine torch

¹Hard Body Torches with HFC (high temperature fiber reinforced composite material) provide the best performance, heat resistance, abrasion resistance, and high frequency resistance. ²Rubber bodies provide improved resistance to breakage in rough-duty.

ESAB has made a model change on the HW-9 series torches. The new designation for that series of torches is HW-90.

ESAB has made a model change on the HW-20A series torches. The new designation for that series of torches is HW-9.

Old Designation	New Designation
HW-9	HW-90
HW-20A	HW-9
HW-20AR	HW-9R
HW-20AF	HW-9F
HW-20ARV	HW-9RV
HW-20ARV2	HW-9RV2

HW-24 Torch Family - 80 Amp Gas-Cooled Torches

Arc
Equipment

- Designed to reach into tight places
- Ideal for confined, cramped areas
- High flexibility, one-piece cable
- Miniature head provides maximum accessibility to corners and tight joints
- Excellent visibility
- Gas lens available for improved shielding



Ordering Information

HW-24, 60°, 12.5 ft. (3.8 m)..... 45V17
 HW-24, 90°, 12.5 ft. (3.8 m)..... 527712

Cups, Collets & Collet Bodies

Electrode Size, in (mm)	.020 (0.5)	.040 (1.0)	1/16 (1.6)
Standard collet	53N15	53N16	53N14
Standard collet body	53N17	53N18	53N19
Gas lens collet	53N62	53N63	53N64
Gas lens collet body ¹	45V41	45V42	45V43

¹Also order insulator #53N66.

Cup Number	.165 in. - ID	4=1/4	5=5/16	6=3/8	7=7/16
Ceramic cup	53N23	53N24	53N25	53N27	-
Gas lens high-impact cup	-	53N58	53N59	53N60	53N61

Specifications

HW-24	
Gun capacity	75A @ 100% duty cycle AC or DC with standard accessories
	100A @ 100% duty cycle AC or DC with gas lens accessories
	80A @ 50% duty cycle AC or DC with standard accessories
Dimensions, in. (mm):	
Length	7-3/4 (197)
Length of head	1-1/16 in. (27)
Diameter of head	5/8 (16)
Head angle	60° or 90°
Handle diameter, in. (mm)	3/4 (19)
Weight (less service lines), oz. (g)	2.5 (71)

HW-90 Torch Family - 120 Amp

Gas-Cooled Torches

- HW-90 is designed for small, confined areas where accessibility is the primary concern
- High flexibility one-piece cable
- Available in 60° or 120° heads by exchanging cap and cup
- Also available in Pencil style (180°)
- Excellent visibility
- Gas lens available for improved shielding



Arc
Equipment



Ordering Information

HW-90, 60°, 12.5 ft. (3.8 m)..... 16X28
 HW-90, 60°, 25 ft. (7.6 m)..... 16X44
 HW-90, pencil, 12.5 ft. (3.8 m)..... 16X47

Cups, Collects & Collect Bodies

Electrode Size, in. (mm)	.020 (0.5)	.040 (1.0)	1/16 (1.6)
Standard collet	-	84Z35	84Z33
Standard collet body	-	105Z27	-
Gas lens collet body ¹	45V41	45V42	45V43

¹Also order adaptor #45V52 and insulator #53N85.

Cup Number	4=1/4	5=5/16	6=3/8	7=7/16
High-impact cup	14N65	14N66	14N67	-
Gas lens high-impact cup	53N58	53N59	53N60	53N61

Specifications

	HW-90 60°	HW-90 Pencil
Gun capacity	110A @ 100% duty cycle AC or DC with standard accessories	
	110A @ 100% duty cycle AC or DC with gas lens accessories	
	120A @ 50% duty cycle AC or DC	
Dimensions, in. (mm):		
Length	6-3/4 (171)	7-1/8 (181)
Short cap	3-1/8 (79)	1-1/16 (27)
Long cap	7-1/8 (181)	-
Diameter of head	19/32 (15)	5/8 (16)
Head angle	60/120°	180°
Handle diameter, in. (mm)	3/4 (19)	3/4 (19)
Weight (less service lines), oz. (g)	3 (84)	5 (140)

HW-9 Torch Family - 140 Amp Gas-Cooled Torches

Arc
Equipment

- Compact body provides greater access to weld in confined or restricted areas
- Hard body provides superior heat and abrasion resistance for longest life
- Silicon rubber body provides improved resistance to breakage in rough-duty
- Flexible head models provide added versatility for welding in hard-to-reach applications



Ordering Information

Without Gas Valve

HW-9, 70°, 1pc cable assembly, 12.5 ft. (3.8 m) 19684
 HW-9, 70°, 1pc cable assembly, 25 ft. (7.6 m) 19685
 HW-9F, 70°, 1pc cable assembly, 12.5 ft. (3.8 m) 19922
 HW-9F, 70°, 1pc cable assembly, 25 ft. (7.6 m) 19923

With Gas Valve

HW-9F, 70°, 1pc cable assembly, 25 ft. (7.6 m) 19611
 HW-9R, 70°, 2pc cable/hose assembly, 12.5 ft. (3.8 m) .. 34561
 HW-9R, 70°, 2pc cable/hose assembly, 25 ft. (7.6 m) 34562

F = Flex Head. R = Silicon Rubber.

Cups, Collects & Collect Bodies

Electrode Size, in. (mm)	.020 (0.5)	.040 (1.0)	1/16 (1.6)	3/32 (2.4)	1/8 (3.2)
Standard collet	13N20	13N21	13N22	13N23	13N24
Standard collet body	13N25	13N26	13N27	13N28	13N29
Gas lens collet body	45V41	45V42	45V43	45V44	45V45

Cup Number	4=1/4	5=5/16	6=3/8	7=7/16	8=1/2	10= 5/8
High-impact cup	13N08	13N09	13N10	13N11	13N12	13N13
Gas lens high-impact cup	53N58	53N59	53N60	53N61	-	-

Specifications

HW-9	
Gun capacity	120A @ 100% duty cycle, DC
	85A @ 100% duty cycle, AC
	140A @ 50% duty cycle, DC
	100A @ 50% duty cycle, AC
Dimensions, in. (mm)	
Length	6-7/8 (175)
Short cap	2-19/64 (58)
Medium cap	3-9/32 (83)
Long cap	7-5/16 (186)
Diameter of head	3/4 (19)
Head angle	70° HW Variable HW-9F
Handle diameter, in. (mm)	3/4 (19)
Weight (less service lines), oz. (g)	3.5 (100)



HW-17 Torch Family - 150 Amp

Gas-Cooled Torches

- Quick release of electrodes
- Hard body provides superior heat and abrasion resistance for longest life
- Silicon rubber body provides improved resistance to breakage in rough duty
- Flexible head models provide added versatility for welding in hard-to-reach applications



Arc
Equipment

Ordering Information

Torch Assemblies

HW-17, 60°, 1pc cable/hose, 12.5 ft. (3.8 m).....	16X48
HW-17, 60°, 2pc cable/hose, 12.5 ft. (3.8 m).....	33855
HW-17, 60°, 2pc cable/hose/twistlock, 12.5 ft. (3.8 m).....	35782
HW-17, 60°, 1pc cable/hose, 25 ft. (7.6 m).....	16X50
HW-17, 60°, 2pc cable/hose, 25 ft. (7.6 m).....	33856
HW-17, 90°, 1pc cable/hose, 25 ft. (7.6 m).....	634720
HW-17F, 60°, 1pc cable/hose, 12.5 ft. (3.8 m).....	19881

Torch Assemblies with Slide Valve

HW-17, 60°, 1pc cable/hose, 12.5 ft. (3.8 m).....	634705
HW-17, 60°, 1pc cable/hose, 25 ft. (7.6 m).....	634706
HW-17, 90°, 1pc cable/hose, 25 ft. (7.6 m).....	601152

Torch Assemblies with Rotary Valve

HW-17, 60°, 1pc cable/hose, 12.5 ft. (3.8 m).....	16X48LV
HW-17, 60°, 2pc cable/hose/twistlock, 12.5 ft. (3.8 m).....	35857
HW-17, 60°, 1pc cable/hose, 25 ft. (7.6 m).....	16X50LV
HW-17, 60°, 2pc cable/hose/twistlock, 25 ft. (7.6 m).....	35856
HW-17R, 60°, 1pc cable/hose, 12.5 ft. (3.8 m).....	634705R
HW-17R, 60°, 2pc cable/hose, 12.5 ft. (3.8 m).....	33813R
HW-17R, 60°, 1pc cable/hose, 25 ft. (7.6 m).....	634706R
HW-17R, 60°, 2pc cable/hose, 25 ft. (7.6 m).....	33814R
HW-17F, 60°, 1pc cable/hose, 12.5 ft. (3.8 m).....	19882
HW-17F, 60°, 1pc cable/hose, 25 ft. (7.6 m).....	19884
HW-17F, 60°, torch outfit.....	600997

F = Flex Head. R = Silicon Rubber.

Cups, Collects & Collect Bodies

Electrode Size, in. (mm)	.020 (0.5)	.040 (1.0)	1/16 (1.6)	3/32 (2.4)	1/8 (3.2)
Standard collet	10N21	10N22	10N23	10N24	10N25
Standard collet body	10N29	10N30	10N31	10N32	10N28
Gas lens collet body	45V29	45V24	45V25	45V26	45V27
Lrg diameter lens collet body	-	-	-	45V64	995795

Cup Number	4=1/4	5=5/16	6=3/8	7=7/16	8=1/2	10= 5/8	12=3/4	Short
High-impact cup	10N50	10N49	10N48	10N47	10N46	10N45	10N44	
Gas lens high-impact cup	54N18	54N17	54N16	54N15	54N14	-	-	54N19
Lrg. dia. gas lens, high-impact cup	-	-	-	-	-	53N88	53N87	53N89

Specifications

HW-17	
Gun capacity	130A @ 100% duty cycle, AC or DC 150A @ 50% duty cycle, AC or DC with standard accessories
Dimensions, in. (mm):	
Length	6-7/8 (175)
Short cap	3-13/16 (97)
Medium cap	5-1/4 (133)
Long cap	7-7/16 (189)
Diameter of head	51/64 (20)
Head angle	60° or 90° HW-17, HW-17R Variable HW-17F
Handle diameter, in. (mm)	3/4 (19)
Weight (less service lines), oz. (g)	4.8 (137)

HW-26 Torch Family - 220 Amp Gas-Cooled Torches

Arc
Equipment



- Quick release of electrodes
- Hard body provides superior heat and abrasion resistance for longest life
- Silicon rubber body provides improved resistance to breakage in rough duty
- Flexible head models provide added versatility for welding in hard-to-reach applications



Ordering Information

Torch Assemblies

HW-26, 75°, 1pc cable/hose, 12.5 ft. (3.8 m).....	17137
HW-26, 75°, 2pc cable/hose, 12.5 ft. (3.8 m).....	33857
HW-26, 75°, 1pc cable/hose, 25 ft. (7.6 m).....	46V29
HW-26, 75°, 2pc cable/hose, 25 ft. (7.6 m).....	948127
HW-26F, 75°, 1pc cable/hose, 12.5 ft. (3.8 m).....	33848
HW-26F, 75°, 1pc cable/hose, 25 ft. (7.6 m).....	33849

F = Flex Head. R = Silicon Rubber.

Torch Assemblies with Rotary Valve

HW-26, 75°, 1pc cable/hose, 12.5 ft. (3.8 m).....	17138
HW-26, 75°, 2pc cable/hose/twistlock, 12.5 ft. (3.8 m).....	35858
HW-26, 75°, 1pc cable/hose, 25 ft. (7.6 m).....	46V27
HW-26, 75°, 2pc cable/hose, 25 ft. (7.6 m).....	948128
HW-26R, 75°, 1pc cable/hose, 12.5 ft. (3.8 m).....	17138R
HW-26R, 75°, 1pc cable/hose, 25 ft. (7.6 m).....	46V27R
HW-26R, 75°, 2pc cable/hose, 25 ft. (7.6 m).....	948128R
HW-26F, 75°, 1pc cable/hose, 12.5 ft. (3.8 m).....	33850
HW-26F, 75°, 2pc cable/hose, 12.5 ft. (3.8 m).....	33852
HW-26F, 75°, 1pc cable/hose, 25 ft. (7.6 m).....	33851
HW-26F, 75°, 2pc cable/hose, 25 ft. (7.6 m).....	33853

Cups, Collects & Collect Bodies

Electrode Size, in. (mm)	.020 (0.5)	.040 (1.0)	1/16 (1.6)	3/32 (2.4)	1/8 (3.2)
Standard collet	10N21	10N22	10N23	10N24	10N25
Standard collet body	10N29	10N30	10N31	10N32	10N28
Gas lens collet body	45V29	45V24	45V25	45V26	45V27
Lrg. diameter lens collet body	-	-	-	45V64	995795

Cup Number	4=1/4	5=5/16	6=3/8	7=7/16	8=1/2	10= 5/8	12=3/4	Short
High-impact cup	10N50	10N49	10N48	10N47	10N46	10N45	10N44	
Gas lens high-impact cup	54N18	54N17	54N16	54N15	54N14	-	-	54N19
Lrg. dia. gas lens, high-impact cup	-	-	-	-	-	53N88	53N87	53N89

Specifications

HW-26	
Gun capacity	160A @ 100% duty cycle, AC or DC with standard accessories
	200A @ 100% duty cycle, AC or DC with standard accessories
	150A @ 50% duty cycle, AC or DC with standard accessories
Dimensions, in. (mm):	
Length	8-7/8 (225)
Short cap	3-3/4 (95)
Medium cap	5-3/8 (136)
Long cap	7-3/8 (187)
Diameter of head	29/32 (23)
Head angle	75° HW-26 Variable HW-26F
Handle diameter, in. (mm)	1-7/32 (31)
Weight (less service lines), oz. (g)	7.75 (221)

HW-20 Torch Family - 300 Amp

Water-Cooled Torches

- Compact water-cooled design for higher current applications in confined areas
- Hard body w/HFCTM (HW-20) provides superior heat and abrasion resistance available in 2 versions
- Economical silicon rubber body (HW-20R) provides resistance to breakage



Arc
Equipment



Ordering Information

HW-20, 70°, cable/hose, 12.5 ft. (3.8 m) 948084
 HW-20, 70°, cable/hose, 25 ft. (7.6 m) 948085
 HW-20R, 70°, cable/hose, 12.5 ft. (3.8 m) 948084R
 HW-20R, 70°, cable/hose, 25 ft. (7.6 m) 948085R

R = Silicon Rubber.

Cups, Collects & Collect Bodies

Electrode Size, in. (mm)	.020 (0.5)	.040 (1.0)	1/16 (1.6)	3/32 (2.4)	1/8 (3.2)
Standard collet	13N20	13N21	13N22	13N23	13N24
Standard collet body	13N25	13N26	13N27	13N28	13N29
Gas lens collet body	45V41	45V42	45V43	45V44	45V45

For selection of special ceramic or sleeved cups, see Genuine Heliarc Accessories.

Cup Number	4 = 1/4	5 = 5/16	6 = 3/8	7 = 7/16	8 = 1/2	10 = 5/8
High-impact cup	13N08	13N09	13N10	13N11	13N12	13N13
Gas lens high-impact cup	53N58	53N59	53N60	53N61	-	-

Specifications

HW-20	
Gun capacity	240A @ 100% duty cycle, AC or DC with standard accessories
	250A @ 100% duty cycle, AC or DC with gas lens accessories
	300A @ 50% duty cycle, AC or DC
Dimensions, in. (mm):	
Length	6-7/8 (175)
Short cap	2-19/64 (58)
Medium cap	3-9/32 (83)
Long cap	7-5/16 (186)
Diameter of head	3/4 (19)
Head angle	70°
Handle diameter, in. (mm)	3/4 (19)
Weight (less service lines), oz. (g)	3.5 (100)
Cooling requirements, qt. min. (L/min)	1 (0.94)

HW-18 Torch Family - 425 Amp

Water-Cooled Torches

Arc
Equipment

- The industry standard water-cooled general purpose torch
- Ideal for production welding
- Lightweight - reduces operator fatigue
- Water-tight - brazed, closed cooling system
- Gas lens available for improved shielding
- Hard body w/HFCTM (HW-18) provides superior heat and abrasion resistance for the longest life
- Economical silicon rubber body (HW-18R) provides resistance to breakage



Ordering Information

HW-18, 60°, cable/hose, 12.5 ft. (3.8 m) 948361
 HW-18, 60°, cable/hose, 25 ft. (7.6 m) 948362
 HW-18R, 60°, cable/hose, 12.5 ft. (3.8 m) 948361R
 HW-18R, 60°, cable/hose, 25 ft. (7.6 m) 948362R

R = Silicon Rubber.

Cups, Collects & Collect Bodies

Electrode Size, in. (mm)	.020 (0.5)	.040 (1.0)	1/16 (1.6)	3/32 (2.4)	1/8 (3.2)
Standard collet	10N21	10N22	10N23	10N24	10N25
Standard collet body	10N29	10N30	10N31	10N32	10N28
Gas lens collet body	45V29	45V24	45V25	45V26	45V27
Lrg. diameter lens collet body	-	-	-	45V64	995795

Cup Number	4 = 1/4	5 = 5/16	6 = 3/8	7 = 7/16	8 = 1/2	10 = 5/8	12 = 3/4	Short
High-impact cup	10N50	10N49	10N48	10N47	10N46	10N45	10N44	-
Gas lens high-impact cup	54N18	54N17	54N16	54N15	54N14	-	-	54N19
Lrg. dia. gas lens, high-impact cup	-	-	-	-	-	53N88	53N87	53N89

Specifications

HW-18	
Gun capacity	300A @ 100% duty cycle, AC or DC with standard accessories
	375A @ 100% duty cycle, AC or DC with gas lens accessories
	425A @ 50% duty cycle, AC or DC
Dimensions, in. (mm)	
Length	10-1/2 (267)
Short cap	3-3/16 (81)
Medium cap	5-7/16 (138)
Long cap	7-7/16 (189)
Diameter of head	29/32 (23)
Head angle	60°
Handle diameter, in. (mm)	1-1/16 (27)
Weight (less service lines), oz. (g)	7 (200)
Cooling requirements, qt/min (L/min)	1 (0.94)

HW-25 Torch Family - 200 Amp

Water-Cooled Torches

- Small, lightweight
- Flexible head to access difficult joints



Arc
Equipment



Ordering Information

HW-25, cable assembly, 12.5 ft. (3.6 m)..... 45V36
 HW-25, cable assembly, 25 ft. (7.6 m)..... 45V37

Cups, Collects & Collect Bodies

Electrode Size, in. (mm)	.020 (0.5)	.040 (1.0)	1/16 (1.6)	3/32 (2.4)	1/8 (3.2)
Standard collet	13N20	13N21	13N22	13N23	13N24
Standard collet body	13N25	13N26	13N27	13N28	13N29
Gas lens collet body	45V41	45V42	45V43	45V44	45V45

Cup Number	4 = 1/4	5 = 5/16	6 = 3/8	7 = 7/16	8 = 1/2	10 = 5/8
High-impact cup	13N08	13N09	13N10	13N11	13N12	13N13
Gas lens high-impact cup	53N58	53N59	53N60	53N61	-	-

Specifications

HW-25	
Gun capacity	200A @ 100% duty cycle, AC or DC with standard accessories 210A @ 50% duty cycle, AC or DC with standard or gas lens
Dimensions, in. (mm):	
Length	10-1/2 (267)
Length of head	4-7/8 (124)
Diameter of head	3/4 (19)
Head angle	Flexible
Handle diameter, in. (mm)	3/4 (19)
Weight (less service lines), oz. (g)	14 (400)
Cooling requirements, qt/min (L/min)	1 (0.94)

HW-27 Torch Family - 400 Amp

Water-Cooled Torches

Arc
Equipment

- Front or back loaded
- Internal tungsten adjustment
- Model A with 9 in. (23 cm) length is designed for clamp-type fixture
- Model B with 20 in. (51 cm) length is designed for pinion-type fixture
- Silicon rubber head



Ordering Information

HW-27A, 9 in. (23 cm), 4.5 ft. (1.2 m) cable..... 20955
 HW-27A, 9 in. (23 cm), 12.5 ft. (3.6 m) cable..... 20954
 HW-27B, 20 in. (51 cm), 4.5 ft. (1.2 m) cable 20017
 HW-27B, 20 in. (51 cm), 12.5 ft. (3.6 m) cable 20018

Cups, Collects & Collect Bodies

Electrode Size, in. (mm)	.040 (0.5)	1/16 (1.6)	3/32 (2.4)	1/8 (3.2)	5/32 (4.0)	3/16 (5.0)	1/4 (6.35)
Standard collet	57N45	57N46	57N47	57N48	57N49	57N50	57N51
Standard collet body ¹	-	-	49V24	49V25	49V26	49V27	49V28

¹Includes gasket #57N56.

Cup Number	6=3/8	8=1/2	10=5/8	12=3/4	15=15/16	Short
High-impact cup	-	57N75	57N74	53N88	53N87	53N89

Specifications

	HW-27A	HW-27B
Gun capacity	400A @ 100% duty cycle, AC or DC with high impact cups	
	500A @ 100% duty cycle, AC or DC with metal nozzles	
	400A @ 50% duty cycle, AC or DC	
Dimensions, in. (mm):		
Length	9 (230)	20 (500)
Diameter of torch	1-3/8 (34)	1-3/8 (34)
Weight (less service lines), oz. (g)	24 (680)	36 (1021)
Cooling requirements, qt/min (L/min)	2. (1.91)	2. (1.91)
Maximum pressure, psi	50	50
Electrode capacity, in. (mm)	.040-.025 (1.0-6.35)	.040-0.25 (1.0-6.35)

Collets

Torch	Part Number	Size	
		in.	mm
HW-20, HW-9, HW-25 	13N20	.020	0.5
	13N21	.040	1.0
	13N22	1/16	1.6
	13N23	3/32	2.4
	13N24	1/8	3.2
HW-17, HW-18, HW-26 	10N21	.020	0.5
	10N22	.040	1.0
	10N23	1/16	1.6
	10N24	3/32	2.4
	10N25	1/8	3.2
	54N20	5/32	4.0
	HW-24 Standard Gas Lens 	53N15	.020
53N16		.040	1.0
53N14		1/16	1.6
53N62		.020	0.5
53N63		.040	1.0
HW-90 	84Z35	.040	1.0
	84Z33	1/16	1.6
HW-27 	57N45	.040	1.0
	57N46	1/16	1.6
	57N47	3/32	2.4
	57N48	1/8	3.2
	57N49	5/32	4.0
	57N50	3/16	4.8
	57N51	1/4	6.4

Large Diameter Gas Lens Collet Bodies

Torch	Part Number	Size	
		in.	mm
HW-17, HW-18, HW-26 	45V64	3/32	2.4
	995795	1/8	3.2
	45V63	5/32	4.0

Collet Bodies

Torch	Part Number	Size	
		in.	mm
HW-20, HW-9, HW-25 	13N25	.020	0.5
	13N26	.040	1.0
	13N27	1/16	1.6
	13N28	3/32	2.4
	13N29	1/8	3.2
	HW-17, HW-18, HW-26 	10N29	.020
10N30		.040	1.0
10N31		1/16	1.6
10N32		3/32	2.4
10N28		1/8	3.2
406488		5/32	4.0
HW-24 Standard¹ 		53N17	.020
	53N18	.040	1.0
	53N19	1/16	1.6
HW-90 	105Z27	All Sizes	
HW-27 	49V24	3/32	2.4
	49V25	1/8	3.2
	49V26	5/32	4.0
	49V27	3/16	4.8
	49V28	1/4	6.4

¹Order wrench #53N20 for HW-24 collect body.

Gas Lens Collet Bodies

Torch	Part Number	Size	
		in.	mm
HW-20, HW-9, HW-25 	45V41	.020	0.5
	45V42	.040	1.0
	45V43	1/16	1.6
	45V44	3/32	2.4
	45V45	1/8	3.2
HW-17, HW-18, HW-26 	45V29	.020	0.5
	45V24	.040	1.0
	45V25	1/16	1.6
	45V26	3/32	2.4
	45V27	1/8	3.2
	45V28	5/32	4.0
	HW-90¹, HW-24² 	45V41	.020
45V42		.040	1.0
45V43		1/16	1.6

¹Requires adaptor #45V52/insulator #53N85. ²Requires Insulator #53N66.



Genuine Heliarc® Accessories

Arc
Equipment



Gas Lens

To meet increasingly stringent weld quality standards, we developed the patented GENUINE HELIARC Gas Lens. This stack of concentric, fine-mesh stainless steel screens produces an exceptionally stable stream of shielding gas (see Figure 1). By forcing the gas into a coherent stream, an effective shielding pattern can be projected greater distances (see Figure 2).

Welding is possible at nozzle distances up to 1 in. from the plate surface, allowing greater welder visibility and access to tight joints.

Extending the electrode from the gas cup also increases the current capacity of some torch models. For example, a gas lens increases the 100 percent duty rating of our popular Heliarc HW-18 torch from 300 to 375A.

Patented Genuine Heliarc Gas Lens

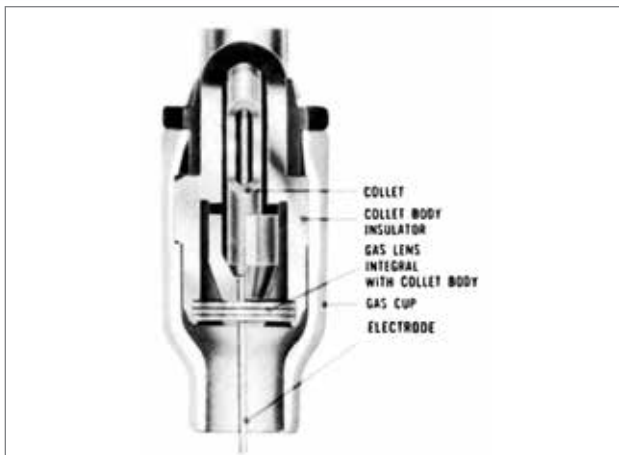

FIG. 1

Conventional Torch

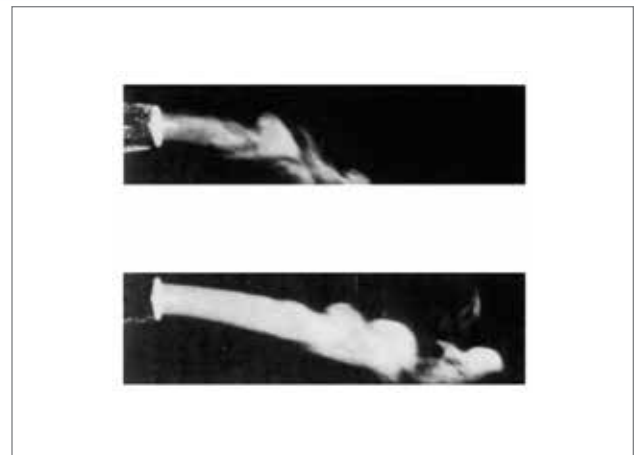

FIG. 2







High Impact Cups

Made from high strength alumina, these high-impact cups have very good electrical insulating properties and exceptionally high impact resistance, heat resistance,

thermal conductivity and spatter build-up resistance. They are recommended for most welding operations except for use in confined areas.

Standard High-Impact Cups

Torch	Length, in.	Part Number	Size	Orifice	
				in.	mm
 HW-90	1-5/16	14N65	4	1/4	6.4
		14N66	5	5/16	8
		14N67	6	3/8	10
 HW-17, HW-18, HW-26	1-27/32	10N50	4	1/4	6.4
		10N49	5	5/16	8
		10N48	6	3/8	10
		10N47	7	7/16	11
		10N46	8	1/2	12.5
		10N45	10	5/8	16
 HW-20, HW-9, HW-25	1-5/32	13N08	4	1/4	6.4
		13N09	5	5/16	8
		13N10	6	3/8	10
		13N11	7	7/16	11
		13N12	8	1/2	12.5
 HW-27	1-27/32	57N75	6	3/8	10
		57N74	8	1/2	12.5
		53N88	10	5/8	16
		53N87	12	3/4	19
	1-5/16	53N89	15	15/16	24

Ceramic Cups

Made from Grade "A" lava materials are less impact and heat resistant than the high-impact cups, but can be expected to give very good service and long life. They perform very well in confined areas where excessive heat is reflected back into the nozzle. These cups can be used at currents up to 250A DC or AC, depending on arc time and cup size.

Ceramic Cups

Torch	Length, in.	Part Number	Size	Orifice	
				in.	mm
 HW-24	5/8	53N23	.165	.165	4
		53N24	4	1/4	6.4
		53N25	5	5/16	8
		53N27	6	3/8	10



Gas Lens High-Impact Cups

Torch	Length, in.	Part Number	Size	Orifice	
				in.	mm
 HW-17, HW-18, HW-26	1-5/8	54N18	4	1/4	6.4
		54N17	5	5/16	8
		54N16	6	3/8	10
		54N15	7	7/16	11
	1-1/8	54N14	8	1/2	12.5
 HW-90, HW-20, HW-24, HW-9, HW-25	1	54N19	Short	11/16	17
		53N58	4	1/4	6.4
		53N59	5	5/16	8
		53N60	6	3/8	10
		53N61	7	7/16	11
		53N61S	8	1/2	12.7

Large Diameter Gas Lens High-Impact Cups

Torch	Length, in.	Part Number	Size	Orifice	
				in.	mm
 HW-17, HW-18, HW-26	1-7/8	57N75	6	3/8	10
		57N74	8	1/2	12.5
		53N88	10	5/8	16
		53N87	12	3/4	19
	1-5/16	53N89	Short	15/16	24

Special Ceramic Long Cups

Torch	Length, in.	Part Number	Size	Orifice	
				in.	mm
 HW-20, HW-9, HW-25	1-7/8	796F70	3L	3/16	4.8
		796F71	4L	1/4	6.4
		796F72	5L	5/16	8
		796F73	6L	3/8	10
 HW-20 (X-Long), HW-9, HW-25	2-1/2	796F74	3XL	3/16	4.8
		796F75	4XL	1/4	6.4



Genuine Heliarc® Accessories

Each spare parts kit contains those accessory items most requested by our customers for use on our most popular GTAW torches, in easy-to-order kit form, packaged in durable plastic boxes.



Spare Parts Kit

Description	999126 HW-17, 18, 26 TXH-151, 201	999127 HW-20 TXH-121, 251w	999124 HW-90	0558101886 TXH-401w	Quantity
Short torch cap	57Y04	-	-	57Y04	1
Long torch cap	-	41V24	56Y40	-	1
Collet .040 in. (1.0 mm)	-	-	84Z35	-	1
Collet 1/16 in. (1.6 mm)	10N23	13N22	84Z33	10N23	1
Collet 3/32 in. (2.4 mm)	10N24	13N23	-	0157123077	1
Collet 1/8 in. (1.4 mm)	10N25	13N24	-	0157123078	1
Collet body, .020/.040/1/16 in. (0.5/1.0/1.6 mm)	-	-	105Z27	-	1
Collet body, .040-3/32 in. (1.0-2.4 mm)	-	-	-	0157123081	
Collet body, 1/8-3/16 in. (3.2-5.0 mm)	-	-	-	0157123082	
Collet body, 1/16 in. (1.6 mm)	10N31	13N27	-	-	1
Collet body, 3/32 in. (2.4 mm)	10N32	13N28	-	-	1
Collet body, 1/8 in. (1.4 mm)	10N28	13N29	-	-	1
High-impact cup No. 4	-	-	14N65	-	1
High-impact cup No. 5	10N49	13N09	14N66	-	1
High-impact cup No. 6	10N48	13N10	14N67	54N16	1
High-impact cup No. 7	-	13N11	-	54N15	1
High-impact cup No. 8	10N46	-	-	54N14	1
.040 in. dia. x 7 in. long, Ground Finish Tungsten Electrode	-	-	Q796F55	-	1
1/16 in. dia. x 7 in. long, Ground Finish Tungsten Electrode	Q796F58	Q796F58	Q796F58	Q796F58	1
3/32 in. dia. x 7 in. long, Ground Finish Tungsten Electrode	Q796F63	Q796F63		Q796F63	1
1/8 in. dia. x 7 in. long, Ground Finish Tungsten Electrode	Q796F68	Q796F68		Q796F68	1

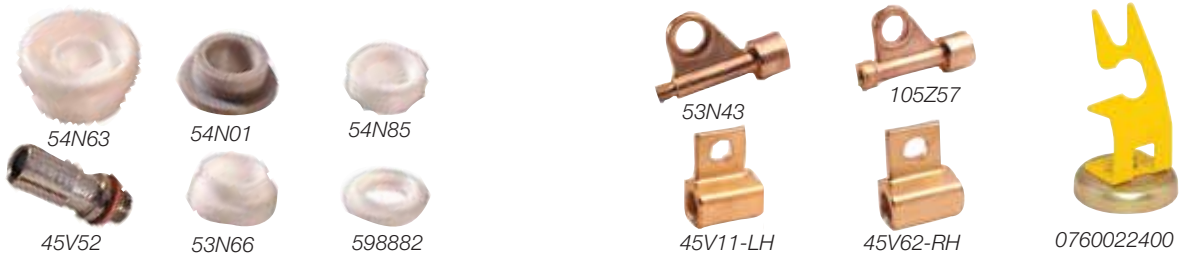

Adaptors & Accessories

Description	Part Number	Used On
Insulator	54N63	HW-17, 18, 26
Insulator	54N01	HW-17, 18, 26
Insulator	53N85	HW-90
Adaptor	45V52	HW-90
Collet body insulator	53N66	HW-24
Cup gasket	598882	HW-20, 9
TIG torch holder	0760022400	All

Power Cable Adaptors

Description	Part Number	Used On
Adaptor	53N43	HW-90, 24
Adaptor	105Z57	HW-17, 9
Adaptor	45V11	HW-18, 20
Adaptor	45V62	HW-26
Fuse assembly	45V34	HW-18, 20
Replacement fuses (5/pk)	54N26, 25A 54N30, 60A	HW-18, 20

Electrodes - Ground Finish Provides Maximum Smoothness

Diameter, in. (mm)	Length, in. (mm)	Pure (EWP) Green Coded	Zirconiated (EWZr-1) Brown Coded	2% Ceriated (EWCe-2) Orange Coded	1.5% Lanthana (EWG) Gray Coded
.040 (1.0)	7 (175)	-	-	-	Q796F55
1/16 (1.6)	7 (175)	Q76Z51	Q790F47	Q798F92	Q796F58
3/32 (2.4)	7 (175)	Q76Z57	Q790F48	Q798F93	Q796F63
1/8 (3.2)	3 (75)	-	-	-	Q796F66
	7 (175)	Q76Z52	Q790F49	Q798F94	Q796F68
5/32 (4.0)	7 (175)	Q81Z43	Q790F50	Q798F95	Q796F84
3/16 (5.0)	7 (175)	-	Q790F51	-	-

Additional electrodes are available. For ordering information consult your ESAB Sales Representative or Distributor. Each package contains ten electrodes. For additional accessories, consult the Genuine Heliarc® Torch Guide #ARC-23110, available for download at esabna.com.

Arc
Equipment



Back Caps

Description	Part Number	Used On
Short cap	41V33	HW-20, 9 TXH-121, 251w
Medium cap	41V35	HW-20, 9 TXH-121, 251w
Long cap	57Y02	HW-17, 18, 26 TXH-151, 201
Medium cap	34015	HW-17, 18, 26 TXH-151, 201
Short cap	57Y04	HW-17, 18, 26 TXH-151, 201
Short cap	84Z31	HW-90
Long cap	56Y40	HW-90



Hoses/Cable Sheaths

Description	Part Number	Used On
Zippered Nylon		
12.5 ft. x 3 in. wide	35453	All
25 ft. x 3 in. wide	35454	All
Non-Zippered		
9 ft. x 7/8 in. I.D.	2075198	HW-20
20 ft. x 7/8 in. I.D.	2075200	
9 ft. x 1-1/4 in. I.D.	2075199	HW-18
10 ft. leather with snaps 6 in. wide	20812	

Widths are as flat.

MiniArc® 161LTS



- The MiniArc 161LTS Automatic Primary Select operates on either 115V or 230V and will automatically configure to the primary input supplied
- Fixed hot start - allows the operator to easily strike an arc without the electrode sticking to the plate
- Fixed arc force - allows the operator to get deeper penetration into the plate without the electrode sticking to the plate
- LiftArc™ TIG gives you the luxury of lifting the tungsten as opposed to traditional scratch starting which can deposit tungsten into the plate resulting in contamination
- Able to use cellulosic 6010 electrodes with ease
- 18 lbs. (13.6 kg) weight - makes this unit portable and easy to carry directly to the job
- Comes with a shoulder strap
- Includes 10 ft. (3 m) work cable with clamp, and 10 ft. (3 m) welding cable with electrode holder
- Thermal indicator prevents the machine from exceeding the duty cycle and from becoming damaged if airflow is blocked
- Simple interface - amperage knob, process switch and on/off switch on front panel of unit
- Small and portable, inverter based
- 5A to 160A current range for DC welding



Ordering Information

Ready to Weld Packages

MiniArc 161LTS, 115/230V, 1ph, SMAW 0558101694
 MiniArc 161LTS, 115/230V, 1ph, GTAW 0558101699

Includes: power source with 10 ft. (3 m) power cord, 115/230V input power adapter cable, 10 ft. (3 m) heavy-duty ground cable and clamp, 10 ft. (3 m), heavy-duty electrode holder and cable, and sample pack of ESAB electrodes.

GTAW Package also includes HW-17FV torch, R33 reg/flowmeter, and GTAW accessory kit.

Options & Accessories

Welding cable 200A, 16.4 ft. (5 m) OKC25..... 0700006882
 Return cable 200A, 16.4 ft. (5 m) OKC25..... 0700006883
 GTAW torch, 17FV, 20 ft. (6 m) & accessory kit 0558101723
 R33-FM-580 regulator/flowmeter 21557
 GTAW torch accessory kit..... 999126

Specifications

MiniArc 161LTS	SMAW (Stick)		GTAW (TIG)	
	115V	230V	115V	230V
Input voltage	115V, 1 ph, 60Hz	230V, 1 ph, 60Hz	115V, 1 ph, 60Hz	230V, 1 ph, 60Hz
Voltage tolerance	+/- 15%	+/- 15%	+/- 15%	+/- 15%
Output range	5A/110A	5A/160A	5A/110A	5A/160A
Permitted load at: 35% duty cycle 100% duty cycle	110A/24.4V 60A/22.4V	160A/26.4V 88A/23.5 V	110A/14.4V 60A/12.4V	160A/16.4V 88/16.4V
Primary current at: 100% duty cycle 35% duty cycle	19A 32.5A	14.5A 28.5A	10.5A 22.5A	8.4A 18.5A
Open circuit voltage (max)	80V	80V	15V	15V
Efficiency	80%		80%	
Power factor	.73		.73	
Net weight, lbs. (kg)	18 (8)		18 (8)	
Dimensions, LxWxH, in. (mm)	15.75x5.75x10 (400x146x255)		15.75x5.75x10 (400x146x255)	



Caddy™ Arc 201i



1 Phase DC CC 3 YEAR WARRANTY 100% DUTY CYCLE

- Caddy Arc features built-in, advanced inverter technology to deliver unparalleled performance in a rugged, portable package
- Adjustable hot start makes it easy to strike the electrode and avoid starting problems
- Adjustable arc force sets the intensity of the arc improving weld quality
- ArcPlus II improves welding characteristics and simplifies work producing better weld quality with less clean up
- Caddy Arc supplies direct current and allows you to weld most metals including alloy and non alloy steel, stainless steel and cast iron. The Caddy Arc 201i welds electrodes up to 5/32 diameter
- For GTAW applications with the Caddy Arc, all you need is a torch with a gas valve, gas regulator, and cylinder of gas
- Features compact design with impact resistant polymer and aluminum casing – makes the unit lightweight and easy to carry
- Small size does not compromise vital cooling of internal components
- Large heat sinks and innovative design make this Caddy machine run cooler – promotes longer machine life even when used in harsh environments
- Built in accordance with IP 23 for outdoor use, even in wet-weather conditions – makes this machine ideal for on-site work
- Equipped with a PFC (Power Factor Correction) circuit – allows the machine to perform a full range of functions on a 16 A fuse, protects against fluctuating input voltage, and makes it safer to use with a generator
- The advanced Caddy A33 panel features digital display with hot-start and arc force control for fine tuning, SMAW or GTAW selection, LiveTig start, two memory settings and remote control



Arc
Equipment



Ordering Information

Caddy Arc 201i, 230V, 1ph..... 0460445884

Includes: 10 ft. (3 m) SMAW welding and return cable kit with "screw" type electrode holder.

Caddy™ Arc 201i

Arc
Equipment



Options & Accessories

Shoulder strap 0460265003

2-Wheel Trolley

Small gas bottle 0459366885

Gas bottle on side 0460330880

Remote Controls

MMA 1, 33 ft. (10 m) cable 0349501024

AT 1 0459491896

AT1 CoarseFine 0459491897

Connection Cables for AT1 and AT1 CoarseFine

16.4 ft. (5 m) 0459552880

33 ft. (10 m) 0459552881

49 ft. (15 m) 0459552882

82 ft. (25 m) 0459552883

Remote foot control, 25 ft. (7.6 m) cable' 0558008905

Torch remote, 25 ft. (7.6 m)' 0558008904

'For use with A33 models only.

GTAW Torches

TXH-151V, 13 ft. (4 m), OKC50 0700300539

TXH-151V, 26 ft. (8 m), OKC50 0700300545

TXH-201V, 13 ft. (4 m), OKC50) 0700300553

TXH-201V, 26 ft. (8 m), OKC50 0700300556

V = Gas Valve.

Specifications

Caddy Arc 201i	
Input voltage	230V, 1ph, 50/60Hz
Fuse (slow), A	16
Recommended generator size	12 kVA
Permitted load at (SMAW):	
25% duty cycle	170A/26.8V
60% duty cycle	130A/25.2V
100% duty cycle	110A/24.4V
Permitted load at (GTAW):	
25% duty cycle	220A/18.8V
60% duty cycle	150A/16.0V
100% duty cycle	140A/15.6V
Setting range, A:	
SMAW	4-170
GTAW	3-220
Open circuit voltage (A33), V	72
Power factor at max. current	0.99
Efficiency at max. current	81
Dimensions, LxWxH, in. (mm)	16.46x7.40x8.19 (418x188x208)
Weight, lbs. (kg)	18.30 (8.3)
Enclosure class	IP 23

Origo™ Arc 410c & 650c



- Sturdy, robust switching converter (chopper) power sources intended for manual heavy-duty welding processes - SMAW (with coated electrodes), GTAW, and air carbon arc gouging (ACAG)
- These machines are built with proven technology, for the highest level of reliability and outstanding welding performance
- Strong metal housing makes Origo Arc ideal for use in harsh industrial environments
- Wide current range makes it easy to optimize settings, allowing the machine to be used with an extensive range of consumables
- These units are equipped with functions such as hot start, arc force, and anti-stick; also adjust parameters during the welding process
- The units have vertical static characteristics, which means that regardless of cable length and arc voltage, the current remains constant
- The dynamic characteristics of the Origo Arc ensure a stable, spatter-free arc, and an easily controlled molten pool
- Due to the high power factor, energy consumption is low, and installation costs can be kept to a minimum
- The welding properties of the Origo Arc units are configured to meet the requirements of welding with cellulosic electrodes
- The arc is very flexible when starting from the lowest currents
- When the arc is shortened, arc force makes weld penetration easier - especially when the electrode is pressed against the welded material
- Origo Arc 410c and 650c are equipped with the A12 control panel - a full-featured control panel with a V/A instrument and a receiver for wireless current setting
- As an option, the Origo Arc range can be equipped with remote control
- Automatic switch-off prevents overheating



Arc
Equipment



Ordering Information

Origo Arc 410c, A12

USA - 230/460V, 3ph, 60Hz 0349312420
Canada - 230/460/550V, 3ph, 60Hz 0349310650

Origo Arc 650c, A12

230/460, 3ph, 60Hz 0349312430

Includes: wheel kit/undercarriage and 16 ft. (5 m) primary cable.

Options & Accessories

Remote Controls

NO₂ wireless 0349304617
MMA 1, 33 ft. (10 m) 0349501024
AT1 0459491896
AT1 CoarseFine 0459491897

Wheel kit 0349312090

Remote Connection Cables

16.4 ft. (5 m) analog 12 pole 0459552880
33 ft. (10 m) analog 12 pole 0459552881
49 ft. (15 m) analog 12 pole 0459552882
82 ft. (25 m) analog 12 pole 0459552883

Welding & Work Cables

Welding cable, 16.4 ft. (5m) OKC95, 500A 0700006894
Return cable, 16.4 ft. (5 m) OKC95, 500A 0700006895

Origo™ Arc 410c & 650c

Arc
Equipment

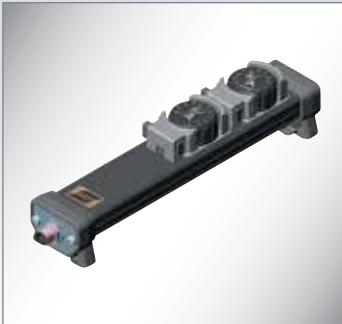

AT1 CoarseFine Remote Control.....0459491897



NO₂ Wireless Remote Control Unit..0349304617

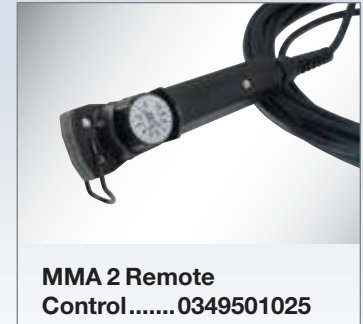

MMA 2 Remote Control.....0349501025



AT1 Remote Control.....0459491896



MMA 1 Remote Control.....0349501024

Specifications

	Origo Arc 410c	Origo Arc 650c
Input voltage	230/460/550V, 3,ph, 60Hz ¹	230/460V, 3,ph, 60,Hz
Permitted load at: 35% duty cycle 60% duty cycle 100% duty cycle	400A/36V 310A/33V 240A/30V	650A/44V 490A/40V 400A/36V
Primary current at: 35% duty cycle 60% duty cycle 100% duty cycle	54A/28A 38A/20A 27A/14A	109A/57A 69A/36A 57A/30 A
Setting range (DC)	20A/20V-400A/36V	20A/20V-650A/44V
Open circuit voltage	53-70V	53-70V
Open circuit power	390W	510W
Power factor at maximum current	0.90	0.90
Efficiency at maximum current	74%	77%
Dimensions, LxWxH, in. (mm)	51.5x31.5x30.7 (1310x800x780)	51.5x31.5x30.7 (1310x800x780)
Weight, lbs. (kg)	346 (157)	491 (223)
Operating temperature, °F (°C)	14 to 104 (-10 to 40)	14 to 104 (-10 to 40)
Enclosure class	IP 23	IP 23

¹550V applies to Origo Arc 410c in Canada only.



Warrior™ 500i with Warrior Feed 304

3Phase DC CVCC 3 YEAR WARRANTY 100% DUTY CYCLE

- Designed with input from real-world welders and built with ESAB's leading-edge engineering
- Multi-Process - Warrior is designed for GMAW, FCAW (Flux-Cored), SMAW, and GTAW applications, as well as ACAG (Arc Gouging), and delivers up to 500A @ 60% duty cycle
- Welds .030-5/64 in. (0.8-2.4 mm) flux cored and solid wires
- Great short arc performance with 500A
- Full range of SMAW capabilities with excellent 7018 and 6010 performance
- Arc gouges with electrodes up to 3/8 in. (5 mm)
- Inverter technology - increased energy efficiency and more power from a lighter, smaller, and more portable unit
- Generator friendly - compatible to work with generators when power is not accessible in the field
- AutoFan™ feature reduces energy consumption and dirt intake
- High duty cycle for long runs across a variety of applications
- Automatic Hot Start/Variable Arc Control allows the welder to fine-tune the arc to get best possible weld performance and optimize hot start, arc force, and inductance settings with total arc control
- Power, gas, and control cables are in an all-in-one bundle with quick disconnect plugs to reduce setup time, housed in a tough, protective cover for longer cable life
- All controls, including power switch, are located on the all-in-one front panel
- Read-anywhere display - easy to read settings outdoors and from a wide range of angles
- Ergonomically designed handles, built to withstand mechanical hoisting
- Durable and rugged - IP 23 rating for outdoor and indoor use in rough environments



Ordering Information

Ready to Weld Packages

USA

Warrior 500i, 380/460/575V, 3ph, 5.5 ft. (1.7 m) .. 0558101760

Warrior 500i, 380/460/575V, 3ph, 32 ft. (9.7 m) .. 0558101761

Canada

Warrior 500i, 380/460/575V, 3ph, 5.5 ft. (1.7 m) .. 0561000155

Warrior 500i, 380/460/575V, 3ph, 16.4 ft. (5 m) .. 0561000156

Includes: power source, 5.5 ft. (1.7 m), 16 ft. (5 m), or 32 ft. (9.7 m) cable connection set, Warrior Feed 304 4-roll wire feeder, .035/.045 in. (0.9/1.2 mm) V-groove drive rolls/guide tube, Gunmaster 400cc torch with .035-.045 in. (0.9-1.2 mm) accessories, R-33-FM-580 gas regulator/flowmeter, 49 ft. (15 m) work cable/ground clamp. Input power cable is not included.

Canada package also includes trolley with wheels & 1-cylinder rack.

MobileFeed 300AVS Wire Feeder Package

Warrior 500i/MobileFeed, 380/460/575V, 3ph .. 0558101762

Includes: .052/1/16 in. (1.4/1.6 mm) K-groove drive rolls, GunMaster 400cc torch with .052-1/16 in. (1.4-1.6 mm) accessories. Regulator/flowmeter and cylinder cart not included.

Basic Packages

Warrior 500i, 380/460/575V, 3ph, 5.5 ft. (1.7 m) . 0558101759

Includes: power source, feeder, 15 ft. (4.5 m) 400A torch.

Power Source Only

Warrior 500i, 380/460/575V, 3ph..... 0465350881

Warrior Power Source Pack (includes 4 power sources)

Warrior 500i power source 4-pack' 0588002000

'Specify input voltage when ordering.

Instruction Manual, Warrior 500i.....	0463341031
Instruction Manual, Warrior Feed 304	0463343031
Product Data Page	ARC-23304

Warrior™ 500i

with Warrior Feed 304

Arc
Equipment



Options & Accessories

Feeder Accessories

Wheel kit	0458707880
Strain relief for welding torch	0457341881
Feeder strain relief for connection cables	0459234880
Lifting eye	0458706880
Quick connector Marathon Pac adaptor	0558002354
Adaptor for 11-lb (5-kg) spool	0455410001
Steel spool cover, 12 in. (305 mm).....	0459431880

Counterbalance MiniBoom

For 12 in. (305 mm) spools	0458705880
For 18 in. (457 mm) spools	0458705882

Extension arm for 60-lb coil (18 in. spools).....	0459233880
Coil adaptor for 60-lb (27.2-kg) coils ¹	34323
Female gas hose quick-connector.....	0365803002
Gas flow checker	19043
PrecisionMaster gas saver kit	0558007079
Remote kit, Warrior power source.....	0465424880

¹Requires extension arm #0459233880.

Connection Cable Sets, Air-Cooled Torch

5.6 ft. (1.7 m)	0459836880
32.8 ft. (10 m)	0459836882
49.2 ft. (15 m)	0459836883
82 ft. (25 m)	0459836884

Control Panel



Power Source Accessories

Auto transformer, 208/230/460V, 3ph	0588002040
-------------------------------------------	------------

Electrode Holder Assemblies

175A, 15 ft. (4.5 m)	0558001791
300A, 15 ft. (4.5 m)	21226

Trolley, 1 cylinder	0465510880
Wheel kit	0465416880
Water cooler	0465427880

Remote Controls

Remote kit	0465424880
FS003-B remote foot control, 25 ft. (7.6 m)	0558008905
RCA-2B remote torch control, 25 ft. (7.6 m)	0558008904
Remote control AT1 analog	0459491896
Remote control AT1 course-fine analog ¹	0459491897
Cable interconnect analog 12P, 16.4 ft. (5 m) ..	0459552880
Cable interconnect analog 12P, 33 ft. (10 m) ...	0459552881
Cable interconnect analog 12P, 50 ft. (15 m) ...	0459552882
Cable interconnect analog 12P, 82 ft. (25 m) ...	0459552883
Warrior 500i spool gun option	0588002061
Remote adaptor kit, Miggytrac/Railtrac	0465451880

¹Order cable separately.

Work Cable Extensions

16.4 ft. (5 m) - 2/0 AWG	0558101878
33 ft. (10 m) - 2/0 AWG	0558101879
50 ft. (15 m) - 2/0 AWG	0558101880
82 ft. (25 m) - 2/0 AWG	0558101881
82 ft. (25 m) - 4/0 AWG	0558101882
115 ft. (35 m) - 4/0 AWG	0558101883

Instruction Manual, Warrior 500i.....	0463341031
Instruction Manual, Warrior Feed 304	0463343031
Product Data Page	ARC-23304

Warrior™ 500i with Warrior Feed 304



Options & Accessories continued

Warrior Feed 304 Wire Feeder

Warrior Feed 304	0465250880
Warrior Feed 304w ¹	0465250881
Warrior Feed 304 for ST-21 & ST-16	0588002048
Warrior Feed 304 NAS ²	0558002068

Warrior Feed 304 has 4-roll drive system and 19 pole amphenol cable connection. Includes digital meters, .035/.045 in. (0.9/1.2 mm) V-groove drive rolls/guide tube and spool enclosure.

¹Includes water solenoid connections.

²Special order upon request.



Mobilefeed 300 AVS 4-Roll Suitcase Wire Feeder

Mobilefeed 300 AVS LC-40	0558005729
--------------------------------	------------

This optional wire feeder includes digital meter, gas solenoid valve, contactor, LC-40 male connector and .045-1/16 in. (1.2-1.6 m) serrated drive rolls.



Feed Roll Kits

V-Groove .023-.030 in. (0.6-0.8 mm)	0558003134
V-Groove .035-.045 in. (0.9-1.14 mm)	0558003135
V-Groove .052-1/16 in. (1.3-1.6 mm)	0558003136
K-Groove 035-.045 in. (0.9-1.14 mm)	0558003137
K-Groove 045-.052 in. (1.14-1.3 mm)	0558003138
K-Groove 1/16-5/64 in. (1.6-2.0 mm)	0558003139

GMAW Torches

GunMaster 400cc, 25 ft. (7.6 m) basic	0558001674
GunMaster 400cc, 12 ft. (3.6 m) x .035-.045 in.	0558001667
GunMaster 400cc, 15 ft. (4.5 m) x .035-.045 in.	0558001669
GunMaster 400cc, 15 ft. (4.5 m) x .052-1/16 in.	0558001670

GTAW Torches

HW-17V-2TL, 12.5 ft. (3.6 m)	35857
HW-17V-2TL, 25 ft. (7.6 m)	35856
HW-26V-2TL, 12.5 ft. (3.6 m)	35858
HW-17, 18, 26 accessory kit	999126

V = Gas Valve.

Gouging Torch

Q4000 gouging torch package, 10 ft. (3 m)	Q61-082-009
------------------------------------------------	-------------

Warrior 500i can be paralleled to utilize larger gouging rods.



Warrior Feed 304 Front Panel

Warrior Feed 304 Wire Feeder Data

Power Supply	Wire Spool Capacity, lbs. (kg)	Max. Spool Diameter, in. (mm)	Wire Feed Speed, ipm (m/min)	Dimensions (LxWxH), in. (mm)	Weight Enclosed, lbs. (kg)	Wire Dimensions, in. (mm)	
42 VAC, 50/60 Hz	44 (18)	12 (300) ¹	32-1000 (0.8-25)	27 x11x16 (690 x 275 x 420)	33 (15)	Steel	.023-1/16 (0.6-1.6)
						Stainless steel	.023-1/16 (0.6-1.6)
						Aluminum	.040-1/16 (0.8-1.6)
						Cored wire	.030-1/16 (0.9-1.6)

¹Enclosed.

Warrior™ 500i

with Warrior Feed 304

Warrior Feed 304 Wire Feeder Wear Parts

Arc
Equipment



Wire Diameter, in. (mm)	Wire Type	1 Feeder Roller (4 required)	2 Inlet Nozzle	3 Intermediate Nozzle	4 Outlet Nozzle	Groove Type	Marking
023/.030 (0.6-0.8)	Fe, Ss, C	0459052001	0455049001	0455072002	0469837880	V	0.6 S2 / 0.8 S2
.030/.035-.040 (0.8/0.9-1.0)	Fe, Ss, C	0459052002	0455049001	0455072002	0469837880	V	0.8 S2 / 1.0 S2
.035-.040/.045 (0.9-1.0/1.1)	Fe, Ss, C	0459052003	0455049001	0455072002	0469837880	V	1.0 S2 / 1.2 S2
.052/1/16 (1.3/1.6)	Fe, Ss, C	0459052013	0455049001	0455072002	0469837880	V	1.4 S2 / 1.6 S2
.035-.040/.045 (0.9-1.0/1.1)	C	0458825001	0455049001	0455072002	0469837880	V-K	1.0 R2 / 1.2 R2
.045/.045 (1.1/1.1)	C	0458825010	0455049001	0455072002	0469837880	V-K	1.2 R2 / 1.2 R2
.045/.052 (1.1/1.3)	C	37319	0455049001	0455072002	0469837880	V-K	1.2 R2 / 1.4 R2
1/16-5/64 (1.6-2.0)	C	37320	0455049001	0455072002	0469837880	V-K	1.6 R2
.035-3/64 (0.8-0.9)	Al	36860	0455049001	0456615001	0469837881	U	0.8 A2 / 1.0 A2
3/64-1/16 (0.9-1.6)	Al	36861	0455049001	0456615001	0469837881	U	1.2 A2 / 1.6 A2

C = cored wire, K = knurled groove.
'As delivered.

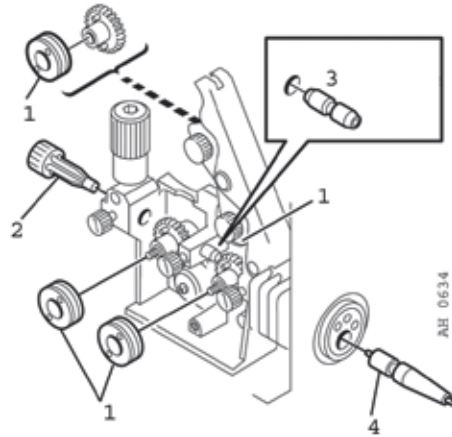

Specifications

Warrior 500i	
Input voltage	380/460/575V, 3ph, 50/60Hz
Permitted load at: 60% duty cycle 100% duty cycle	500A/40 V 400A/36 V
Setting range: GMAW/FCAW (MIG)/GTAW (TIG) SMAW (STICK)	16-500A 4-500A
Open circuit voltage	54V
Open circuit power	500W
Power factor at maximum current	0.92
Efficiency at maximum current	88%
Dimensions, LxWxH, in. (mm)	28.1x12.8 x18.5 (712x325x470)
Weight, lbs. (kg)	115 (52)
Operating temperature, °F (°C)	14 to 104 (-10 to 40)
Enclosure class	IP 23

Instruction Manual, Warrior 500i..... 0463341031
 Instruction Manual, Warrior Feed 304 0463343031
 Product Data PageARC-23304



Origo™ Mig 652c

with Origo Feed 304 M13u



- The Origo Mig 652c meets the demands of the cost-conscious fabricator for high productivity, versatility, and high quality production with low overall welding costs
- The wide current and voltage range together with stepless, dial adjusted inductance make it easy to optimize settings for a wide variety of filler metals and gases
- Multi-voltage - ready to work anywhere
- Robust power technology and digital V/A meter
- Stepless voltage control - for precise settings and remote control (optional)
- Large wheels, undercarriage and sturdy lifting eyelets allow the Origo Mig 652c to be lifted by a forklift
- Sturdy galvanized metal casing with air filter (optional)
- Durable and rugged - IP 23 rating for outdoor and indoor use in rough environments



Arc
Equipment



Ordering Information

Origo Mig 652c, 230/440-460V, 3ph* 0349312380

Includes: power source, 16.4 ft. (5 m) work cable, wheels, gas bottle platform and guide pin for wire feeder.

**Available in USA only.*

Options & Accessories

Origo Feed 304 M13u wire feeder 0459115860

Air filter 0349302252

Electrode holder assembly QC, 15 ft. (4.5 m) 21226

Power source strain relief for connection cables.. 0349311700

Cable and torch holder 0349303362

Dual cylinder tray kit..... 0349312780

Work Cable Assemblies

15 ft. (4.5 m) w/clamp OKC50 36253

32 ft. (9.8 m) w/clamp OKC50 0558001906

Remote Controls

AT1 0459491896

AT1 CoarseFine 0459491897

LiftArc start kit..... 0349311530

Connection Cable Sets, Air-Cooled Torch

5.6 ft. (1.7 m) 0349312460

16.4 ft. (5 m) 0349312461

33 ft. (10 m) 0349312462

49 ft. (15 m) 0349312463

82 ft. (25 m) 0349312464

115 ft. (35 m) 0349312465

Includes: control cable, electrode cable, and gas hose.

Specifications

Origo Mig 652c	
Input voltage	230/440-460V, 3ph, 60Hz
Permitted load at:	
60% duty cycle	650A/41V
100% duty cycle	500A/39V
Setting range (DC):	
GMAW	40-320A/16-30V
SMAW	14-650A/20-44V
GTAW	21-650A/20-44V
Open circuit voltage	53-60V
Open circuit power	670W
Power factor at maximum current	0.90
Efficiency at maximum current	76%
Control voltage	42V, 50/60Hz
Dimensions, LxWxH, in. (mm)	33x26x33 (830x640x835)
Weight, lbs. (kg)	502 (228)
Operating temperature, °F (°C)	14 to 104 (-10 to 40)
Enclosure class	IP 23

Origo™ Mig 652c

with Origo Feed 304 M13u

Arc
Equipment



Origo Feed 304 M13u

- Remote voltage control, allows local setting of power source voltage output
- Wire feed speed, accurate graduated dial shows settings in 50 ipm (1 m/min) increments
- Adjustable burn-back time to correct stick-out and reduce wear of contact tips
- 2/4 stroke, helps minimize operator fatigue by optionally selecting trigger lock in the 4-stroke mode
- Inching/Gas Purge - inching eliminates unsafe trigger pulls to load wire; gas purge ensures a clean start with pure shield gas
- Creep start - simplifies start/stop and gradual feed of wire to optimize the starts.
- Quick connectors - shortest possible set-up times; no tools required to change feed rolls, connect gas hose, weld cable or control cable
- With its galvanized metal casing, the Origo Feed is ideal for use in tough environments
- Electronically controlled feeding gives accurate and stable arc
- The four wheel roll feeder mechanism with grooves in both feed roll and pressure roll gives stable feeding and low wear on the wire - to avoid operational disturbance
- The feeders are available with either 1.18 in. (30 mm) rolls for wires from .023 in. (0.6 mm) up to 5/64 in. (2.0 mm)
- All operating adjustments are made on the front panel of the feeder, giving a good overview of the settings
- The front panel of the M13u is equipped with switches for inching/gas purge, 2/4 stroke and creep start
- A wire feed speed knob with accurate graduated dial and adjustable burn-back are included
- A remote voltage control is provided with 10 graduations from min. to max. settings
- The panel is easy to operate with accurate setting that suits different needs and demands
- Extra versatility can be provided by utilizing one of the following mounting options for the Origo Feed: counterbalance & mast, wheel kit or hanging bracket



Ordering Information

Basic Packages

Origo Feed 304 M13u with QC.....	0558101668
Origo Feed 304 M13u with lugs	0558101669

Includes: feeder, 400A torch, cables, and R-33 flowmeter.

Feeder Only

Origo Feed 304 M13u	0459115860
---------------------------	------------

Options & Accessories

Feeder Accessories

Wheel kit	0458707880
Strain relief for welding torch	0457341881
Feeder strain relief for connection cables	0459234880
Lifting eye	0458706880
Quick connector Marathon Pac adaptor	0558002354
Adaptor for 11-lb (5-kg) spool	0455410001
Steel spool cover	0459431880

Counterbalance MiniBoom

For 12 in. (305 mm) spools	0458705880
For 18 in. (457 mm) spools	0458705882
Extension bracket for 60-lb coil (18 in. spools)	0459233880
Coil adaptor (requires 0459233880)	34323

Spool Covers

Plastic, 12 in. (305 mm)	0458674880
Steel, 12 in. (457 mm)	0459431880

Origo™ Mig 652c with Origo Feed 304 M13u



Origo Feed 304 M13u Wire Feeder Data

Power Supply	Wire Spool Capacity, lbs. (kg)	Max. Spool Diameter, in. (mm)	Wire Feed Speed, ipm (m/min)	Dimensions (LxWxH), in. (mm)	Weight Enclosed, lbs. (kg)	Wire Dimensions, in. (mm)	
42 VAC, 50/60 Hz	44 (18) or 66 (30) ¹	12 (300) ²	32-1000 (0.8-25)	27 x11x16 (690 x 275 x 420)	33 (15)	Steel	.023-1/16 (0.6-1.6)
						Stainless steel	.023-1/16 (0.6-1.6)
						Aluminum	.030-1/16 (0.8-1.6)
						Cored wire	.035-5/64 (0.9-2.0)

¹Requires optional accessories.
²Enclosed.

Panel MMC (Man-Machine-Communication) Functions

- Remote voltage control
- Wire feed speed
- 2/4 stroke – simplifies handling of the welding torch
- Adjustable burn-back time
- Gas purge/wire inching (standard)
- Creep start

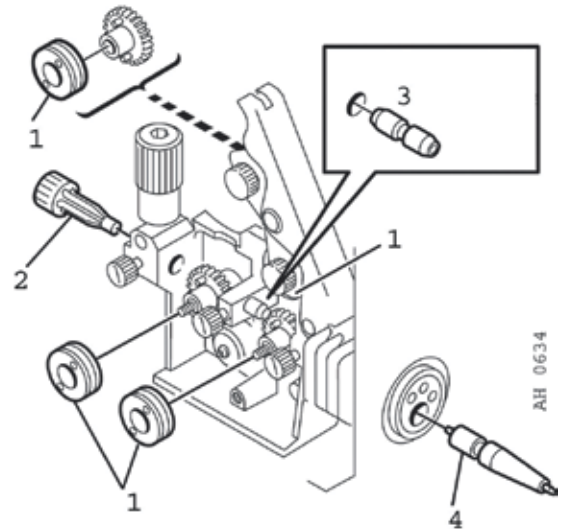

Origo Feed 304 M13u Wire Feeder Wear Parts

Wire Diameter, in. (mm)	Wire Type	1 Feeder Roller (4 required)	2 Inlet Nozzle	3 Intermediate Nozzle	4 Outlet Nozzle	Groove Type	Marking
.023/.030 (0.5-0.8)	Fe, Ss, C	0459052001	0455049001	0455072002	0469837880	V	0.6 S2 / 0.8 S2
.030/.035-.040 (0.8/0.9-1.1)	Fe, Ss, C	0459052002	0455049001	0455072002	0469837880	V	0.8 S2 / 1.0 S2
.035-.040/.045 (0.9-1.1/1.2) ¹	Fe, Ss, C	0459052003	0455049001	0455072002	0469837880	V	1.0 S2 / 1.2 S2
.052/.063 (1.3/1/16)	Fe, Ss, C	0459052013	0455049001	0455072002	0469837880	V	1.4 S2 / 1.6 S2
.035-.040/.045 (0.9-1.1/1.2)	C	0558002352	0455049001	0455072002	0469837880	V-K	1.0 R2 / 1.2 R2
.045/.045 (1.2/1.2)	C	0458825010	0455049001	0455072002	0469837880	V-K	1.2 R2 / 1.2 R2
.045/.052 (1.2/1.3)	C	37319	0455049001	0455072002	0469837880	V-K	1.2 R2 / 1.4 R2
1/16-5/64 (1.6-2.0)	C	37320	0455049001	0455072001	0469837882	V-K	1.6 R2
.035-3/64 (0.8-1.2)	Al	36860	0455049001	0456615001	0469837881	U	0.8 A2 / 1.0 A2
3/64-1/16 (1.2-1.6)	Al	36861	0455049001	0456615001	0469837881	U	1.2 A2 / 1.6 A2

C = Cored Wire. K = Knurled Groove.
¹As delivered.

Arc
Equipment



Origo™ Mig 4002c, 5002cw & 6502c with Origo Feed & Aristo Feed



- Origo Mig multi-voltage power sources operate with Origo Feed and Aristo Feed wire feeders
- Proven technology and ESAB-developed software, for reliable, productive welding performance
- Each unit is constructed with a strong metal casing to withstand harsh environments
- Large wheels, sturdy lifting eyelets, and undercarriage make the unit easy to move
- A dust filter handles tough, dirty environments, and prevents grinding dust and metal particles from entering the chassis (optional)
- All adjustments are made on the man-machine communication panels (MMC) of the feeder, providing a good overview of the settings
- The feeders have rolls with a diameter of 1.18 in. (30 mm) for wires up to 1/16 in. (1.6 mm) diameter



Arc
Equipment



Power Source Specifications

		Origo Mig 4002c	Origo Mig 5002cw	Origo Mig 6502c
Input voltage:	USA Canada	230/460V, 3ph, 60 Hz 230/460/575V, 3ph, 60Hz	- 230/460/575V, 3ph, 60Hz	230/460V, 3ph, 60 Hz 230/460/575V, 3ph, 60Hz
Permitted load at:	60% duty cycle 100% duty cycle	400A/34V 310A/30V	500A/39V 400A/34V	650A/44V 500A/39V
Primary current at:	60% duty cycle 100% duty cycle	56/29/22A 43/25/20A	75/39/30A 57/33/26A	103/59/52A 80/46/33A
Setting range, DC:	GMAW/FCAW SMAW	16–400A/8–34V 16–400A/8–36V	16–500A/8–39V 16–500A/8–40V	16–650A/8–44V 16–650A/8–44V
Open circuit voltage:	GMAW/FCAW SMAW	70V 61V	70V 61V	70V 61V
Open circuit power		500W	550W	670W
In energy saving mode, 15 min. after welding		60W	60W	60W
Power factor at maximum current		0.88	0.90	0.90
Efficiency at maximum current		70%	72%	76%
Control voltage		42V, 50/60Hz	42V, 50/60Hz	42V, 50/60Hz
Dimensions, LxWxH, in. (mm)		32.6x25x32.8 (830x640x 835)	32.6x 25x32.8 (830x640x835)	32.6x 25x32.8 (830x640x835)
Weight, lbs. (kg)		328 (149)	407 (185)	489 (222)
Weight with cooling unit, lbs. (kg)		-	438 (199)	-
Operating temperature, °F (°C)		14 to 104 (-10 to 40)	14 to 104 (-10 to 40)	14 to 104 (-10 to 40)
Enclosure class		IP 23	IP 23	IP 23

Origo Feed/Aristo Feed Wire Feeder Data

Power Supply	Wire Spool Capacity, lbs. (kg)	Max. Spool Diameter, in. (mm)	Wire Feed Speed, ipm (m/min)	Dimension (L x W x H), in. (mm)	Weight Enclosed, lbs. (kg)	Wire Dimensions, in. (mm)	
42 VAC, 50/60 Hz	44 (19) or 60 (27) ¹	12 (300) ²	32-1000 (0.8-25)	27.1 x 10.8 x 16.1 (690 x 275 x 420)	33 (15)	Steel	.023–.062 (0.6–1.6)
						Stainless steel	.023–.062 (0.6–1.6)
						Aluminum	.040–.062 (1.0–1.6)
						Cored wire	.030–.062 (0.8–1.6)

¹Requires optional accessories.

²Enclosed.

Instruction Manual, MA23/MA24 Panel..... 0460454187
 Instruction Manual, U6 Panel 0459287287
 Instruction Manual, U82 Plus Panel 0460896187

Instruction Manual, Origo/Aristo Feed 3004 0444408187
 Product Data PageARC-23309

Origo™ Mig 4002c, 5002cw & 6502c with Origo Feed & Aristo Feed

Wire Feeder Options

Origo Feed 3004 MA23 - Basic



A sturdy, easy-to-use wire feeder with the features you need for reliable GMAW and SMAW applications.

- 2/4 stroke simplifies handling the welding torch
- Process select and gas pre/post flow
- Digital V/A meters
- Gas purge/wire inching
- Memory for 3 parameter sets
- Quick connectors – shorten setup times
- TrueArcVoltage™ system measures the correct arc voltage value independent of the length of the connection cable, or welding torch

Origo Feed 3004 MA24 - Guided



The MA24 panel offers QSet™, a unique function that optimizes welding parameters in short arc for solid wire welding in stainless and carbon steels. Simply set the wire feed speed, and QSet will automatically select the correct welding parameters for the required wire/gas combination.

- All of the features from the MA23, plus...
- Creep start provides a softer, more direct start with less spatter
- Crater filling
- Pre-programmed synergic lines ensure optimum settings with a wide choice of materials, wire dimensions, and gas combinations

Aristo Feed 3004 U6 - Advanced



Aristo Feed units offer the ability to create synergic lines, allowing one-knob setup for welding with solid wire, cored wire, metal-cored wire, and various gas mixes. The feeder can also be set up for DC pulse and synergic pulse welding.

- All of the features from the MA24, plus...
- Ability to create up to 60 synergic lines
- Memory for 10 parameter sets
- DC pulse and synergic pulse welding

Aristo Feed 3004 U8₂ - Sophisticated



The U8₂ panel adds SuperPulse™ technology for exceptional heat control.

- All of the features from the U6, plus...
- 230 pre-programmed synergic lines
- Memory for 255 parameter sets
- SuperPulse – for superior control of heat input
- Remote operator pendant
- Ability to create your own synergic lines



Origo™ Mig 4002c, 5002cw & 6502c with Origo Feed & Aristo Feed



Ordering Information

Canada

Origo Mig 4002c Packages

Origo Mig 4002c, MA23, ready-to-weld.....	0561000060
Origo Mig 4002c, MA23, basic.....	0561000061
Origo Mig 4002c, MA24, ready-to-weld.....	0561000062
Origo Mig 4002c, MA24, basic.....	0561000063
Origo Mig 4002c, U6, ready-to-weld.....	0561000064
Origo Mig 4002c, U6, basic.....	0561000065
Origo Mig 4002c, U82 Plus, ready-to-weld.....	0561000066
Origo Mig 4002c, U82 Plus, basic.....	0561000067
Origo Mig 4002c, U82 Plus, dual feeder.....	0561000069

Origo Mig 5002cw Packages

Origo Mig 5002cw, MA23, basic.....	0561000081
Origo Mig 5002cw, MA24, basic.....	0561000083
Origo Mig 5002cw, U6, basic.....	0561000085
Origo Mig 5002cw, U82 Plus, basic.....	0561000087
Origo Mig 5002cw, U82 Plus, dual feeder.....	0561000089

w = Built-in water-cooler.

Origo Mig 6502c Packages

Origo Mig 6502c, MA23, ready-to-weld.....	0561000090
Origo Mig 6502c, MA23, basic.....	0561000091
Origo Mig 6502c, MA24, ready-to-weld.....	0561000092
Origo Mig 6502c, MA24, basic.....	0561000093
Origo Mig 6502c, U6, ready-to-weld.....	0561000094
Origo Mig 6502c, U6, basic.....	0561000095
Origo Mig 6502c, U82 Plus, ready-to-weld.....	0561000096
Origo Mig 6502c, U82 Plus, basic.....	0561000097
Origo Mig 6502c, U82 Plus, dual feeder.....	0561000099

230/460/575V, 3ph, ready to weld package includes: power source, 16.4 ft. (5 m) work cable/ground clamp, factory installed wheel kit, 6 ft. (1.7 m) cable connection kit, wire feeder, .035/.045 in. (0.9/1.2 mm) V-groove drive rolls/guide tube, swivel mounting post for wire feeder, gas cylinder rack, Gunmaster 400cc welding torch with .035/.045 in. (0.9/1.2 mm) accessories and gas regulator/flowmeter. Input power cable is not included.

Basic packages do not include the welding torch.

USA

Origo Mig 4002c Packages

Origo Mig 4002c, MA23, ready-to-weld.....	0558101332
Origo Mig 4002c, MA23, basic.....	0558101333
Origo Mig 4002c, MA24, ready-to-weld.....	0558101338
Origo Mig 4002c, MA24, basic.....	0558101339
Origo Mig 4002c, U6, ready-to-weld.....	0558101344
Origo Mig 4002c, U6, basic.....	0558101345
Origo Mig 4002c, U82 Plus, ready-to-weld.....	0558101354
Origo Mig 4002c, U82 Plus, basic.....	0558101355
Origo Mig 4002c, U82 Plus, dual feeder.....	0558101366

Origo Mig 6502c Packages

Origo Mig 6502c, MA23, ready-to-weld.....	0558101336
Origo Mig 6502c, MA23, basic.....	0558101337
Origo Mig 6502c, MA24, ready-to-weld.....	0558101342
Origo Mig 6502c, MA24, basic.....	0558101343
Origo Mig 6502c, U6, ready-to-weld.....	0558101348
Origo Mig 6502c, U6, basic.....	0558101349
Origo Mig 6502c, U82 Plus, ready-to-weld.....	0558101358
Origo Mig 6502c, U82 Plus, basic.....	0558101359
Origo Mig 6502c, U82 Plus, dual feeder.....	0558101368

230/460V, 3ph, ready to weld package includes: power source, wire feeder, 15 ft. (4.5 m) 400A torch, 5.5 ft. (1.7 m) connection cable set, 16.4 ft. (5 m) work cable, regulator/flowmeter Ar CO₂.

Basic package includes: power source, wire feeder, 15 ft. (4.5 m) 400A torch.



Origo™ Mig 4002c, 5002cw & 6502c with Origo Feed & Aristo Feed



Options & Accessories

Power Source Accessories

Air filter.....	0349302252
Electrode holder assembly, 300A, 15 ft. (4.5 m)	21226
Strain relief for interconnection cables.....	0349311700
Cable and torch holder	0349303362
Dual cylinder rack	0349312780
Origo Feed dual feeder manual switch.....	0588001819
Work cable & clamp, 15 ft. (4.5 m)	36253
Work cable & clamp, 32 ft. (9.8 m)	0558008683
MMC cable to power supply.....	0458357885
MMC panel A24	0459773887

GunMaster 400cc Torches

25 ft. (7.6 m), basic.....	0558001674
12 ft. (3.6 m) x .035-.045 in. (0.9-1.2 mm).....	0558001667
15 ft. (4.5 m) x .035-.045 in. (0.9-1.2 mm) ¹	0558001669
15 ft. (4.5 m) x .052-1/16 in. (1.4-1.6 mm)	0558001670

¹Included in standard package.

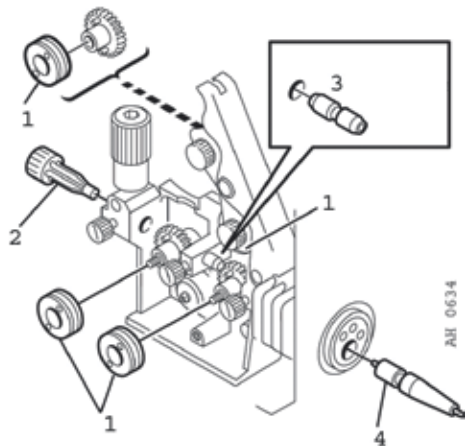

Feeder Accessories

Marathon Pac™ inlet guide ¹	0558002354
Feed selector CD complete ²	0349311825
Spool adaptor, 8 in. (203 mm), 11-lb (5 kg) SP.	0455410001
Aristo Pendant U8 ₂ Plus complete w/holder ...	0460820881
Aristo Pendant extension cable, 16 ft. (5 m)	0456280881
Aristo Pendant extension cable, 33 ft. (10 m) ..	0456280882
Spool cover, plastic.....	0458674880
Spool cover, metal	0459431880
Lifting eye	0458706880
Strain relief for welding torch	0457341881
Strain relief for interconnection cable kit	0459234880
Counterbalance MiniBoom.....	0458705880
Wheel kit.....	0458707880
Feeder extension arm - coil adaptor	0459233880

Connection Cable Kits, 10-P Amphenol

Canada (Water-Cooled)	USA (Air-Cooled)		
5.6 ft. (1.7 m) ..	0459528990	5.6 ft. (1.7 m) ..	0349312450
16.4 ft. (5 m) ...	0459528991	16.4 ft. (5 m) ...	0349312451
33 ft. (10 m)	0459528992	33 ft. (10 m)	0349312452
50 ft. (15 m)	0459528993	50 ft. (15 m)	0349312453
82 ft. (25 m)	0459528994	82 ft. (25 m)	0349312454
115 ft. (35 m) ..	0459528995	115 ft. (35 m) ..	0349312455

Remote Controls

MXH push-pull adaptor kit, basic.....	0459020883
MXH push-pull adaptor kit, WFS/Volt control .	0459681881
Remote adaptor kit, Miggytrac/Railtrac	0459681880
Remote control MTA1 CAN ³	0459491880
Remote control M1 10PROG CAN ³	0459491882

Interconnection Cables CAN w/Amph 10P

16.4 ft. (5 m)	0459960880
33 ft. (10 m)	0459960881
82 ft. (25 m)	0459960882

¹Adapts QCA conduit adaptor to feed unit.

²Requires Aristo Pendant U8₂ and two Aristo Feed U8₂ wire feeders.

³Requires remote extension cable 45996088x.

Origo Feed/Aristo Feed Wire Feeder Wear parts

Wire Diameter, in. (mm)	Wire Type	1 Feeder Roller	2 Inlet Nozzle	3 Intermediate Nozzle	4 Outlet Nozzle	Groove Type	Marking
.023/.030 (0.5-0.8)	Fe, Ss, C	0459052001	0455049001	0455072002	0469837880	V	0.6 S2 & 0.8 S2
.030/.035-.040 (0.8/0.9-1.1)	Fe, Ss, C	0459052002	0455049001	0455072002	0469837880	V	0.8 S2 & 1.0 S2
.035-.040/.045 (0.9-1.1/1.2) ¹	Fe, Ss, C	0459052003	0455049001	0455072002	0469837880	V	1.0 S2 & 1.2 S2
.052/.063 (1.3/1/16)	Fe, Ss, C	0459052013	0459049001	0455072002	0469837880	V	1.4 S2 & 1.6 S2
.035-.040/.045 (0.9-1.1/1.2)	C	0458825001	0455049001	0455072002	0469837880	V-K	1.0 R2 & 1.2 R2
.045/.052 (1.2/1.3)	C	0458825002	0455049001	0455072002	0469837880	V-K	1.2 R2 & 1.4 R2
.063 (1/16)	C	0458825003	0459049001	0455072002	0469837880	V-K	1.6 R2
.030/.035-.040 (0.8/0.9-1.1)	Al	0458824001	0455049001	0456615001	0469837880	U	0.8 A2 & 1.0 A2
3/64/.062 (1.2/1/16)	Al	0458824003	0455049001	0456615001	0469837880	U	1.2 A2 & 1.6 A2

C = cored wire, K = knurled groove. ¹As delivered.

Instruction Manual, MA23/MA24 Panel.....	0460454187
Instruction Manual, U6 Panel	0459287287

Instruction Manual, U82 Plus Panel	0460896187
Instruction Manual, Origo/Aristo Feed 3004	0444408187
Product Data Page	ARC-23309

Equipment
Arc



Aristo® Mig 5000i/U5000i with Aristo Feed



- Multi-process; GMAW, pulse GMAW, SMAW, GTAW, Pulse GTAW and carbon arc gouging
- The ideal welding package for efficient production or pre-fabrication of high demand applications with high alloyed materials
- Chassis made of extruded aluminum sections; Alutech™, a robust material that withstands rough treatment
- The power source is based on inverter IGBT technology that provides reliable equipment with outstanding welding characteristics
- The control and communication CAN-bus system means less cables, increasing operational reliability
- The power source is optimized to operate together with Aristo Feed 3004w U6 and U8 wire feeders
- Define and store customized synergic lines for any material or gas combinations; memory for 10 (U6) or 256 (U8) welding parameters
- Connection cables up to 115 ft. (35 m) provide a working radius of up to 115 ft. (35 m)
- The TrueArcVoltage™ System guarantees welding with the correct arc voltage independent of any voltage drop in the welding cables; same arc voltage and weld result whether setup with a short connection cable and 10 ft. (3 m) gun or 115 ft. (35 m) working radius
- Dust filter handles tough, dirty environments and avoids grinding-dust and metal particles inside the chassis
- Aristo SuperPulse process with the ability to control the heat input (U8 Pendant)



Arc
Equipment



Ordering Information

USA

Aristo Mig 5000i, 460V, 3ph, 60Hz 0459230884
 Aristo Mig U5000i, 460V, 3ph, 60Hz 0459230885
 Aristo Mig U5000iw 460V, 3ph, 60Hz¹ 0459230886

¹With built-in water cooler. Work cable not included.

Canada

Aristo Mig 5000i, 208-575V, 3 ph, 60Hz 0459230880MV
 Aristo Mig 5000iw, 208-575V, 3ph, 60Hz¹ ... 0459230881MV

¹With built-in water cooler. Aristo Mig power sources have 12-pole Burndy connector. Power source includes 16.4 ft. (5 m) work cable with ground clamp.

Ordering Information continued

Aristo Feed Wire Feeders

Aristo Feed 3004w, U6 Panel 0460526896
 Aristo Feed 3004w, U8 Panel¹ 0460526891

Aristo Feed 3004w wire feeders have 4-roll drive system and 10-pole amphenol cable connection. Wire feeders include water kit, spool enclosure, .035/.045 in. (0.9/1.2 mm) V-groove drive rolls and guide tube.

¹Aristo Feed 3004w U8 panel requires Aristo Pendant U8₂ Plus #0460820881.

Options & Accessories

Handle (complete set = 2)¹ 0459307881
 Trolley 1 (standard) 0458530880
 Trolley 2 (with MiniBoom or Dual Feeder) 0458603880
 Guide pin (if no trolley) 0458731880
 Quick Connector Kit² 0459546880

MMC kits for MMC panel mounted in the:

Power source 0459579880
 MMC - U6 0458535890

Connection Cables, Water Cooled Torches

5.6 ft. (1.7 m) 0459528970
 16.4 ft. (5 m) 0459528971
 33 ft. (10 m) 0459528972
 49 ft. (15 m) 0459528973
 82 ft. (25 m) 0459528974
 115 ft. (35 m) 0459528975

ESAT service kit 0458847881

¹Includes mounting screws for separate installation.

²For current, water and shielding gas supply for 2x Aristo Feed.

Instruction Manual 0459264001
 Product Data Page ARC-23143

Aristo® Mig 5000i/U5000i with Aristo Feed



Remote Controls - CAN (order cable separately)

MTA1 CAN' 0459491880
M1 10 Program CAN® 0459491882

¹Multi-function remote control for the following panels: A2, A4, TA4, TA6, MA4, MA6, U6, U8.

²Synergic MIG for MA6, U6, U8.

Remote Control MTA1 CAN

Process	Knob 1	Knob 2
SMAW	Current control	Arc force
GTAW	Pulse current	Background current
GMAW 1	Wire feed speed	Voltage control
GMAW 2	Wire feed speed	Voltage trim +/-



Remote Control M1 10Prog CAN

Process	Knob 1	Switch 1 Function
GMAW 2	1-10 Memory Select	Voltage trim +/-



Remote Control Cables - CAN

Length, ft. (m)	CAN 12 Pin ¹	CAN 10 Pin ²
0.8 (0.25)	0459554884	0459960883
16.4 (5)	0459554880	0459960880
33 (10)	0459554881	0459960881
49 (15)	0459554882	-
82 (25)	0459554883	0459960882
16.4 (5) HD	0459554880	0459960880
33 (10) HD	-	0459960881
82 (25) HD	-	0459960882

¹Used with Aristo Feed U8₂ & M0 wire feeders.

²Used with Aristo Feed U6 wire feeder.

Specifications

Aristo Mig 5000i, U5000i, U5000iw	
Input voltage:	
USA	460V, 3ph, 60Hz
Canada	208/230/460/575V, 3ph, 60Hz
Fuse slow, A	35
Setting range, DC:	
GMAW	16-500/8-60
SMAW	16-500
GTAW	4-500
Permitted load at:	
60% duty cycle	500/39
100% duty cycle	400/34
Open circuit voltage, V	68-88
Energy save mode, W	50
Input power, kW	23
Power factor at max current	0.85
Efficiency at max current, %	86
Control voltage, V, Hz	42, 50/60
Dimensions, LxWxH, in. (mm):	
Without cooling unit	25 x16 x20 (625x394x496)
With cooling unit	25x16 x31 (625x394x776)
Enclosure class	IP 23
Insulation class (main trafo.)	H
Operating temperature, °F (°C)	32 to 104 (-10 to 40)
Weight, lbs. (kg)	152 (69)
Application class	S
Standards	IEC/EN 60974-1, EN 50199
Water Cooling Unit	
Cooling capacity, W, gal/min (L/min)	2500 at 104°F (40°C), 0.4 (1.5)
Coolant volume, gal/min (L/min)	1.4 (5.5)
Max flow, gal/min (L/min)	0.5 (2.0)
Max pressure, psi (bar)	50 (3.4)
Weight, lbs. (kg)	44.1 (20)
Dimensions, LxWxH, in. (mm)	25 x16 x11 (621x389x266)

Arc
Equipment



Aristo® SuperPulse™

Innovative process for heat input control

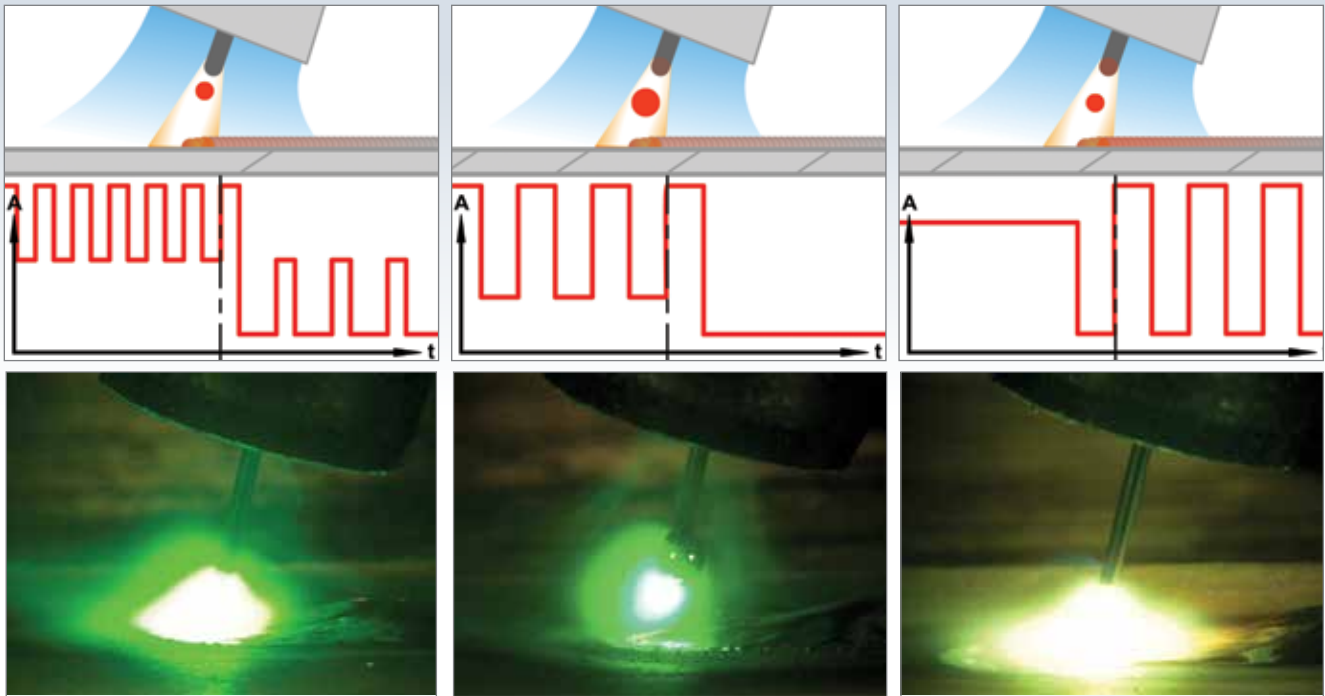

Pulse/Pulse

Pulse/Short Arc

Spray/Pulse

Aristo SuperPulse is a further development of the Pulse/Pulse concept, giving full control over the heat input and thereby expanding the scope of application of the GMAW process. In addition to Pulse/Pulse, the following arc mode combinations and applications are possible:

- Pulse/Short Arc enables the welding of very thin sheet metal
- Productive welding of root passes replacing the GTAW process
- Spray Arc/Pulse - very efficient arc mode for positional welding of thick materials
- Aluminum can be welded straight upwards, without weaving
- GMAW brazing of very thin sheet material

Aristo SuperPulse Benefits:

- Easier positional welding
- Uniform penetration
- Less sensitive for root gap variations
- Less sensitive for unequal heat transfer
- GTAW weld appearance with the GMAW process
- Suitable for automated welding, e.g./with Railtrac and Miggytrac automated welding tractors
- Extends the working range for larger wire sizes
- With its precisely adjustable heat input and depth of penetration, Aristo SuperPulse can solve difficult welding tasks and increase productivity



MobileFeed 300AVS Wire Feeder



- Arc voltage feeder for use with DC, CC or CV power supplies with straight (DC-) or reverse (DC+) polarity operation - no switches to set
- Ideal for harsh environments such as pipelines, shipyards, offshore, general fabrication and more
- For use with 8 or 12 in. (203-305 mm) wire spools for enhanced portability, smaller size and reduced weight
- Enclosed, super impact-resistant case protects against dirt, metal grit, and moisture as well as extreme abuse, from grinding sparks, corrosive chemicals, drops, and more
- 'CC' Euro torch connection for fast setup - no external gas hose or trigger wire
- Heavy-duty 4-roll feed unit with PWM drive provides powerful, dependable wire feeding with automatic slow wire run-in, and Electronic Dynamic Braking for overall improved operation
- Safety features include insulated case, secondary contactor, low voltage torch trigger circuit, and overload protection
- Designed to meet the most rigid standards - meets IEC-974-1 specifications



Arc Equipment

Ordering Information

MobileFeed 300AVS 0558005729

*Includes: gas solenoid, contactor, and dual groove feed rolls.
Uses LC-40 type cable connector.*

Options & Accessories

OKC50 Connectors [2 in. (50 mm)]

OKC female cable connector, 1/0-4/0 cable 13735631
OKC male cable connector, 1/0-4/0 cable 13732513

LC40 Cable Connectors

LC40 cable connector set (male/female), 1/0-3/0 81F25
LC40 male cable connector, 1/0-3/0 81F26
LC40 female cable connector, 1/0-3/0 81F27

Spool Adaptors

Use for adapting to 8 in. (203 mm) diameter spools .. 17511
Use for adapting to 10 in. (254 mm) diameter spools 34330

Gas meter (measures gas flow at the gun) 19043

Specifications

MobileFeed 300AVS	
Wire speed range, ipm (m/min) ¹	50-800 (1.8-20.3)
Permitted load at 100% duty cycle	400A
Wire diameter capacity, in. (mm)	.023-5/64 (0.6-2.0)
Wire spool capacity, in. x lbs. (mm x kg)	12 x 44 (305x20)
Primary input (open circuit voltage or arc voltage)	
Minimum	16.5 VDC
Maximum	100 VDC (113V peak)
Weight, lbs. (kg)	32 (14.5)
Dimensions, LxWxH, in. (mm)	20.7x8.6x17.2 (217x437x526)

*MobileFeed 300AVS will fit through 18 in. (457 mm) dia. hole. Not for use with AC power sources.
¹Actual speed range depends on the arc voltage.*

MobileFeed 300AVS Wire Feeder

Arc
Equipment

Drive Rolls & Guide Tubes

Wire Diameter, in. (mm)	Description	Roll	Qty	Guide Tube	Qty	Center Guide	Qty	Inlet Guide	Qty
.023 (0.6)	V-Solid	21155	2	0558001077	1	0558001757	1	0558001758	1
.030 (0.8)	V-Solid	21155	2	0558001077	1	0558001757	1	0558001758	1
.035 (0.9) ¹	V-Solid	21156	2	0558001078	1	0558001757 ²	1	0558001758	1
.045 (1.2) ¹	V-Solid	21156	2	0558001078	1	0558001757 ²	1	0558001758	1
.052 (1.4)	V-Solid	21157	2	0558001079	1	0558001757	1	0558001758	1
.062 (1.6)	V-Solid	21157	2	0558001079	1	0558001757	1	0558001758	1
.030 (0.8)	K-Cored	21160	2	0558001077	1	0558001757	1	0558001758	1
.035 (0.9)	K-Cored	21160	2	0558001078	1	0558001757	1	0558001758	1
.045 (1.2) ²	K-Cored	21161 ¹	2	0558001079 ¹	1	0558001757	1	0558001758 ¹	1
.052 (1.4) ²	K-Cored	21161 ¹	2	0558001079 ¹	1	0558001757	1	0558001758 ¹	1
1/16 (1.6) ²	K-Cored	21161 ¹	2	0558001079 ¹	1	0558001757	1	0558001758 ¹	1
5/64 (2.0)	K-Cored	21162	2	0558001079	1	0558001757	1	0558001758	1
3/64 (1.2)	U-Soft	21159	2	0558001898	1	0558001895	1	0558001758	1
1/16 (1.6)	U-Soft	21159	2	0558001898	1	0558001895	1	0558001758	1

Two lower drive rolls are required for four roll drive systems. Use flat, smooth pressure roll(s) #23612397 supplied with wire feeder.
¹As delivered on #0558005729.



Wire Feeder Accessories



Arc
Equipment

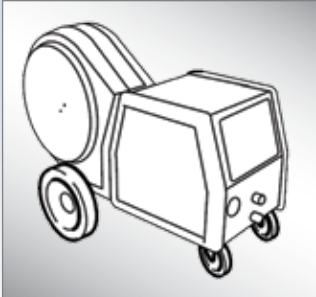

Wheel Kit.....0458707880
Increases the working radius from the power source. The wheel kit has four wheels and can also be placed to pivot on the power source.



Strain Relief for Welding Torch0457341881
Recommended in combination with wheel kit.



Feeder Strain Relief for Connection Cables.....0459234880



Quick Connector Marathon Pac 0558002354
Allows connection of QCA Adaptor to Aristo Feed inlet.

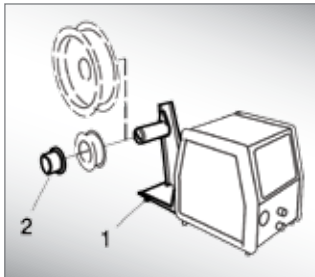

Adaptor for 11-lb (5 kg) Spool.....0455410001

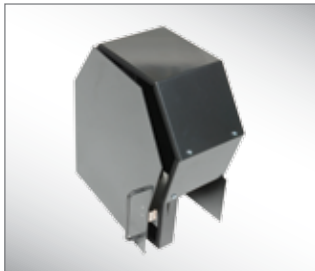

Steel Spool Cover.....0459431880
12 in. (305 mm) spools.

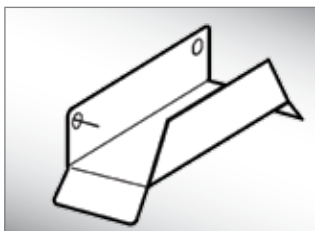

Cable and Torch Holder0349303362



Coil Adaptor34323

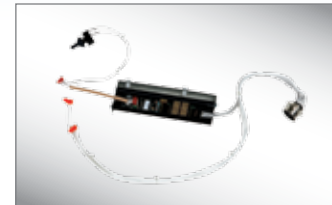

Miggytrac/Railtrac Remote Adaptor for CAN feeders MA23, MA24, U6, U82/M0..... 0459681880



Lifting Eye...0458706880
Using this device, the feeder unit can be suspended in a swinging arm.

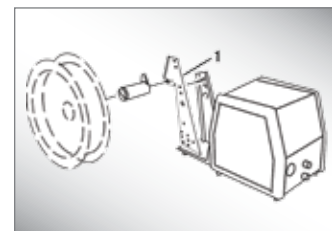

60 lb Coil Extension Bracket0459233880
For use with coil adaptor.

Wire Feeder Accessories

Arc
Equipment



**Counter Balance
MiniBoom ...0458705880**

The feeder unit is assembled with a spring unit which lifts the welding torch and hose with adjustable force. The lifting force is independent of the weight of the wire spool. The device can be rotated through 360°.

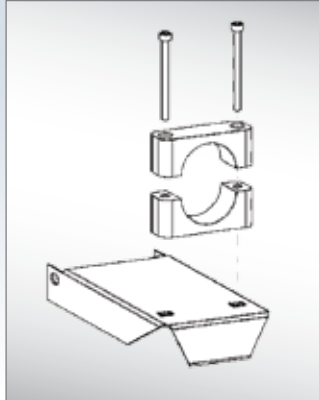

**Power Source Strain
Relief for Connection
Cables0349311700**

Recommended when moving power supply frequently and use of long connection sets.



**Remote Control
MTA1 CAN...0459491880**

(Requires remote connection cable)
CAN-based, multi-function remote control for the control panels MA23, MA24.

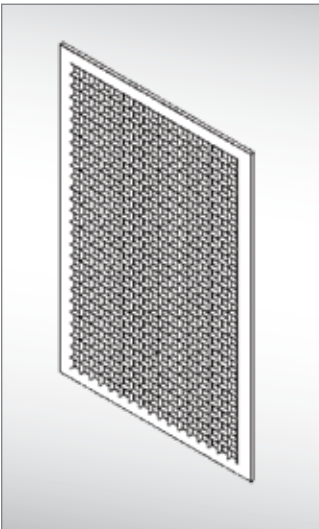

Air Filter0349302252

Cleanable/reusable, optional filter. Extends time between required maintenance and protects components in harsh environments. For use with Origo Mig 4002c/5002cw/6502c.



**Electrode Holder
Assembly QD21226**



**Remote Control M1
10Prog.....0459491882**

(Requires remote connection cable)
CAN-based Synergic MIG for control panel MA23, MA24, U6, and U8₂ Plus.

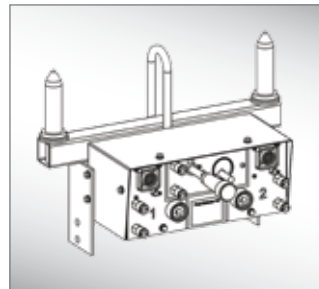

**Feed
Selector0349301152**

Allows the use of the two 3004 feeds M0 with a U8₂ Plus on MIG 4002c/5002c/6502c.

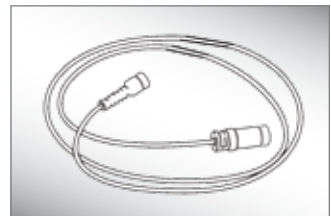

**Remote
Connection Cable
for CAN0459960880**

(Requires MTA or M1 10Prog CAN remote) CAN
4 pole - 10 pole 16.4 ft. (5 m).

Counterbalance MiniBoom

- Up to 25 ft. (7.6 m) working radius - effective area of over 1900 sqft. (579 m²)
- 350° working envelope
- Mounts easily to power source, inverter cart or stationary pedestal
- Adjustable boom length
- Adjustable counterbalance spring

Ordering Information

Counterbalance MiniBoom

12 in. (305 mm) 44-lb. (20-kg) coils 0458705880
 18 in. (457 mm) 65-lb. (25.5-kg) coils 0458705882

For Origo Feed, Aristo Feed, and Warrior Feed wire feeders.

Options & Accessories

Swivel post 36172
 Inverter cart 31700
 Swivel post with bracket 34075
 Stabilizer (Origo Mig 320)¹ 0349303475
 Reinforcer kit (Origo Mig 410)¹ 0349309748
 Stabilizer (Origo Mig 410)¹ 0349303474
 Aristo Mig swivel post² 0458731880
 Aristo Mig trolley and dual cylinder rack 0458603880

¹Required to add MiniBoom power source indicated.

²Required with no cart.

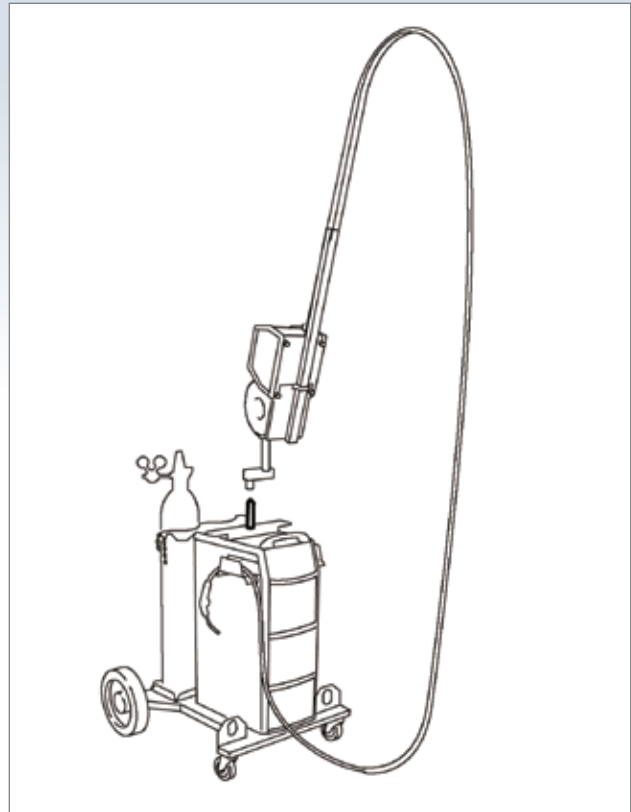

Aristo Mig power source, Aristo Mig wire feeder, 25ft. (7.6 m) torch, MiniBoom and Trolley Cart with 2 gas cylinder capacity shown.



Balanced Boom Assembly

- Extends a 12 ft. (4 m) or 15 ft. (4.5 m) torch's reach from a 20 ft. (6 m) radius up to a 31 ft. (9.5 m) radius
- 350° envelope of operation in most uses
- Boom adjusts from 50° up to 6° down from horizontal position, can be used for tall weldments
- Fully balances feeder weight for fingertip control of feeder height, no lever jacking
- Mast has 6.5 ft. (2 m) clearance from floor to boom support pin
- Standard mounting directly to concrete floor
- Pallet and cart mounting options available
- Extremely rugged steel construction for years of continuous use
- Weld parameters easily adjustable on the standard feeder at the end of boom
- Wire spools mountable to mast or feed wire from Marathon Pac

Ordering Information

Balanced Boom Assembly

8 ft. (2.4 m), B-8/FHD	0558004002
10 ft. (3 m), B-10/FHD	0558004006
12 ft. (3.6 m), B-12/FHD	0558003734
16.4 ft. (5 m), B-16/FHD	0558003737

Options & Accessories

Plastic Troughs

8 ft. (2.4 m)	0558004004
10 ft. (3 m)	0558004008
12 ft. (3.7 m)	0558003447
16.4 ft. (5 m)	0558003732

Troughs neatly contain cables and hoses to feeder.

Boom mounting bracket kit ¹	0558005581
Feeder strain relief for torch ¹	0457341881
ERS conduit bushing support bracket ²	37770
Spindle assembly ³	948259
Coil adapter for 60-lb (27-kg) coils	34323
Pallet base ⁴	37776
Welding cart with wheels ⁵	37777
Inlet guide, 0.2-1 in. (4-30 mm), Marathon Pac ⁶ ..	0558002354

¹For Origo Feed and Aristo Feed wire feeders.

²Used with spindle assembly #948259 (holds conduit inlet inline with spool).

³For mast mounted spools - requires 1/4 in. hardware.

⁴Requires anchoring to floor in-use.

⁵Use with 12 ft. maximum boom and 300+ lbs. power source.

⁶Accepts QCA adaptor #899F50.

See Marathon Pac conduits to guide wire from Marathon Pacs or mast mounted spindles. Add 4 ft. to boom length to get conduit length for mast mounted spindle. Add at least 7 ft. plus boom length for Marathon Pac payed wire.

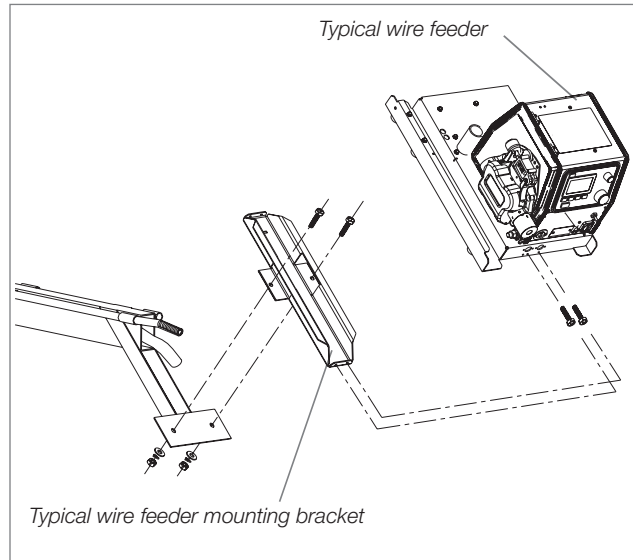
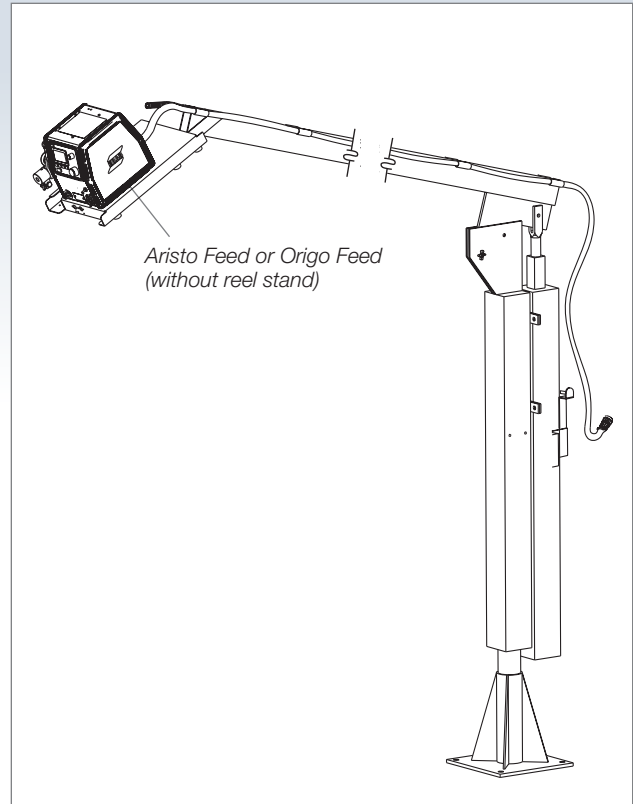

Remote Controls



MTA1 CAN

- CAN based multi function remote control for control panels A2, A4, T4, T6, M2, MA4, MA6, U6, and AristoPendant U8₂ Plus

MTA1 CAN 0459491880



M1

- Analogue standard MIG for control panels M10, M12, M13, M13i and M14
- Stick/TIG: Wire feed and voltage control

M1 0459491895



M1 10Prog CAN

- CAN based Synergic MIG for control panels MA6, U6 and AristoPendant U8₂ Plus
- Stick/TIG: Memory 1-10 and voltage trim +/-

M1 10Prog CAN 0459491882



AT1 Coarse

- Analogue standard Stick and TIG for power sources with remote outlet
- Stick/TIG: Current control

AT1 Coarse 0459491896



AT1 CAN

- CAN based standard Stick and TIG for control panels A2, A4, T4, and T6
- Stick/TIG: Current control

AT1 CAN 0459491883



AT1 Coarse/Fine

- Analogue standard Stick and TIG for power sources with remote outlet
- Stick/TIG: Current control, coarse/fine

AT1 Coarse 0459491897



AT1 Coarse/Fine CAN

- CAN based standard Stick and TIG for control panels A2, A4, T4, and T6
- Stick/TIG: Current control, coarse/fine

AT1 Coarse/Fine CAN 0459491884



Remote Adaptors for CAN Based Systems

- For analog Stick and TIG remote controls. For analog MIG remote controls and 3-step program switch RS3

RA 12 for Stick and TIG 0459491910

RA T1 TIG remote torch 12 pole¹ 0459491912

RA T1 TIG remote torch 10 pole¹ 0459491913

¹Includes holder and cable.

Remote Controls



Foot Control - GTAW

- Complete with 16.5 ft (5 m) rubber cable and equipped with 12-pole Burndy

FS003-B analog remote 25 ft. (7.6 m)..... 0558008905
 T1 CAN for Caddy Tig 0460315880



Remote Control MMA1

- MMA 1 is equipped with 1 potentiometers for current setting
- Includes 33 ft. (10 m) rubber cable equipped with a 12-pole Burndy and a metal hook

MMA1 0349501024

Interconnection Cables 10 pole

Size, ft. (m)	Part Number
0.8 (0.25)	0459960883
16.4 (5)	0459960880
33 (10)	0459960881
82 (25)	0459960882
16.4 (5) HD	0459960880
33 (10) HD	0459960881
82 (25 m) HD	0459960882

Interconnection Cables 12 pole

Size, ft. (m)	Part Number
0.8 (0.25) CAN	0459554884
16.4 (5) CAN	0459554880
33 (10)	0459554881
49 (15) CAN	0459554882
66 (20) CAN	0459554883
16.4 (5) ANALOG 23 p	0459553880
16.4 (5) ANALOG 12 p	0459552880
33 (10) ANALOG 12 p	0459552881
49 (15) ANALOG 12 p	0459552882
82 (25) ANALOG 12 p	0459552883

	MTA 1 CAN	M 110 Prog CAN	AT1 CAN	AT1 Coarse Fine CAN	M1	AT1 Coarse	AT1 Coarse Fine	Foot Control TIG FS002	MMA1
Caddy Arc						●	●		●
Caddy Tig						●	●	●	●
ESAB Feed/MEK					●				
Aristo Feed	●	●							
Aristo Tig	●		●	●					
Aristo Mig	●	●	●	●					

Remote Controls

HC-3B hand pendant control (CC-Amps/CV-Volts) .. 33838

30 ft. (9 m) cable. Provides remote control of process switch (cv/cc), contactor switch (on/off) and output control.

TC-2B torch control 33839

25 ft. (7.5 m) cable. Attach to torch handle. Provides remote current control and contactor (on/off) control

TC-3A remote torch switch, HW-9, 17, 20, 20A, 24... 35783

TC-3A remote torch switch, HW-18, 26R..... 36680

30 ft. (9 m) cable. Provides on/off contactor control. Includes push button switch and rubber boot to secure switch to torch handle.

FC-5C foot control 0558004234

30 ft. (9 m) cable. Provides remote current control and contactor (on/off) control.

FC-5B EHD foot control 33841

30 ft. (9 m) cable. Extra heavy-duty foot control provides remote current control and contactor (on/off) control.



FC-5C Foot Control



FC-5B EHD

Twist Lock Connectors

OKC50 Connectors [2 in. (50 mm)]

Quick-acting twist lock connectors for attaching output power cables or torches to power source:

Male for 1/0 to 4/0 cable 13792513

Female for 1/0 to 4/0 cable 13735631

Male for #2 AWG to 1/0 cable 13733936

Female for #2 AWG to 1/0 cable..... 13735632

Quick connector with 1/2 in. threaded stud 13735501

Tee connector (1 male, 2 female)..... 13792804



R-33 Regulator/Flowmeter

R-33-FM-580, Argon, 10-50 cfh flow 21557

R-33-RM-580HB, Argon, 10-50 cfh flow' 0558005172

R-33-FM-320, CO₂, 10-65 cfh flow 21558

Regulator with Lexan flow tube, 3000 psi cylinder gauge. 'For gas hoses needing a "B" fitting added. Refer to Gas section for details.

Hoses/Fittings

Gas Hose Assemblies

3 ft. (0.9 m) 31504

6 ft. (1.8 m) 31503

12.5 ft. (3.8 m) 40V77

25 ft. (7.6 m) 34V38

12.5 ft. (3.8 m) heavy-duty (CO₂) 19416

25 ft. (7.6 m) heavy-duty (CO₂) 19415

Gas hose coupler 11N17

Gas hose coupler, "Y" 950356

Water Hose Assemblies

3 ft. (0.8 m) 20634

6 ft. (1.8 m) 20633

12.5 ft. (3.8 m) 40V76

25 ft. (7.6 m) 406196

Water hose coupler 11N18

1 gallon torch coolant 0560950312

Trolleys

Warrior 500i trolley, 1 cylinder 0465510880

Caddy Mig trolley, large cylinder 0459366887

Caddy Tig trolley, 2-wheel, small cylinder 0459366885

Caddy Tig trolley, 2-wheel, large cylinder..... 0460330880

Aristo Mig trolley and cylinder rack 0458530880

Aristo Mig trolley and dual cylinder rack' 0458603880

'Required for MiniBoom.

Work Cable Extensions

17 ft. (5 m) - 2/0 AWG 0558101878

33 ft. (10 m) - 2/0 AWG 0558101879

50 ft. (15 m) - 2/0 AWG 0558101880

82 ft. (25 m) - 2/0 AWG 0558101881

82 ft. (25 m) - 4/0 AWG 0558101882

115 ft. (35 m) - 4/0 AWG 0558101883

To extend work cables and can be used as MobileFeed electrode cables.

General Accessories

Ground Clamps

- ESAB ground clamps provide the largest workpiece-to-contact area of any clamp on the market
- They assure positive connections and slide easily under steel plate
- Ground clamps help eliminate arc blow, make it easy to change ground location, and assure proper voltage for maximum weld results with all rods

Model	Part Number	Amp Capacity	Type Cable Connection	Weight
200	81F11	200	Mechanical Oval-Point Screw	13 oz.
300	81F12	300	Mechanical Oval-Point Screw	26 oz.
500	81F13	500	Mechanical Oval-Point Screw	35 oz.
MIG-600	0160288001	600	Two Oval-Point Screws	56 oz.
G	82F17	600	Two Oval-Point Screws	52 oz.
EG-500	82F32	500	Bolt and Nut with Support	22 oz.
EG-300	82F31	300	Bolt and Nut with Support	11 oz.

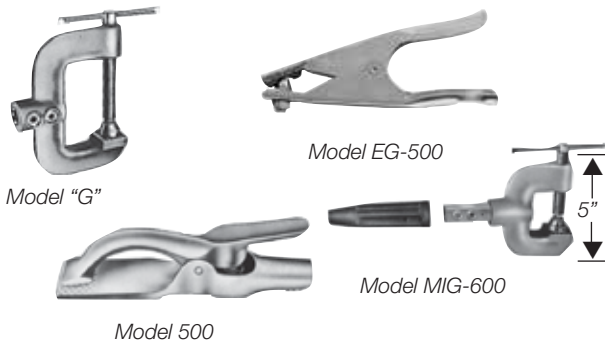

Work/Electrode Holder Cable Assemblies

Includes twist lock OKC 25 1 in. (25 mm) QC plug, 150A 10 ft. (3 m) electrode/work cable assembly..... 0349501078
 10 ft. (3 m) electrode holder cable assembly ... 0349501079

Includes twist lock OKC 50 2 in. (50 mm) QC plug
 10 ft. (3 m) work cable, #3AWG¹ 0780006901
 15 ft. (4.5 m) work cable, 2/0AWG¹ 36253
 15 ft. (4.5 m) work cable, 2/0AWG¹ 35881
 15 ft. (4.5 m) electrode holder 2/0AWG 21226

Includes 1/2 in. (12.5 mm) ring lug
 15 ft. (4.5 m) work cable, 2/0AWG¹ 0558001440

¹Work cables include work clamp.

Cable Connectors

- ESAB cable connectors offer many advantages over older styles. Metal parts are precision machined from heavy, specially shaped brass extrusion. Cam action design of male half connector pulls the two halves tightly together. Connector covers are molded from a special heat and cold resistant material. Covers have no metal liner to rust or corrode. Easily installed with a 1/4 in. Allen wrench.

Model	Part Number	Cable Connection	Cable Capacity	Weight	Std Pack
LC-40	81F25	Oval-Point Screw Mech.	1/0 thru 3/0	17 oz.	1
Same connector style as above - only one half of the set					
LC-40	81F26	Male half	1/0 thru 3/0		
LC-40	81F27	Female half	1/0 thru 3/0		

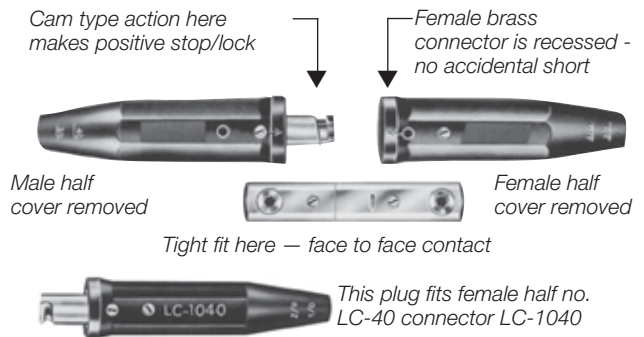

Electrode Holder

- Curved upper lever with low angle design for better hold. Firm electrode grip, fully insulated, high strength spring. High leverage tong designed for easy opening. Heavy-duty shockproof handle.

Part Number	Amp Capacity	Electrode Capacity, in.	Cable Capacity	Length in.	Weight oz.
81F02	300	up to 7/32	2/0	10	20
0558008634	500	up to 3/8	4/0	11	26



Feeder Cable Assemblies

1/2 in.-1/2 in. (12.5 mm) ring lug, 2/0AWG 0558001441
 1/2 in. (12.5 mm) ring lug to 2 in. (50 mm) QC, 2/0AWG .. 36254
 15 ft. (4.5 m).

Plasma Equipment



PowerCut™ 400

15V 15A
20V 20A
25V 25A
30V 30A



Plasmarc® Cutting Equipment

Table of Contents

Plasmarc Processes	80
Plasmarc Equipment Selection Guide	84
Plasma Consoles & Packages	
PowerCut 400	86
PowerCut 700	87
PowerCut 900	88
PowerCut 1300	90
PowerCut 1600	92
ESP-101	94
ESP-150	96
Deuce Pack 150	98
ESP-150 & Deuce Pack 150	100
Manual Plasma Torches	
m3 Precision Plasma System	102
PT-17A/PT-17AM Manual Torch	104
PT-121/PT-121M Manual Torch	106
PT-25 Manual Torch	108
PT-26 Manual/Mechanized Torch	110
PT-27 Manual Torch	112
PT-31XL/PT-31XLPC Manual Torch	114
PT-32EH Manual Torch	116
PT-38 Manual Torch	118
PT-39 Manual Torch	120
Mechanized Plasma Torches	
PT-15XL Mechanized Torch	122
PT-19XLS Mechanized Torch	124
PT-20AMX/21AMX Mechanized Torch	126
PT-36/PT-36R Mechanized Torch	128
PT-37 Mechanized Torch	130
PT-600 Mechanized Torch	133
Plasmarc Accessories	134

Plasmarc® Processes

From the Market Leaders

Since ESAB developed the Plasmarc process in 1957, we have introduced a number of innovations to ensure peak performance in plasma cutting and gouging.

Today, ESAB's Plasmarc product line includes a full range of systems designed to meet your specific needs and applications.

From compact, portable packages to heavy-duty, industrial systems, ESAB plasma cutting equipment offers cutting capacities from 1/8 to 4 in. (3.2 to 101.6 mm).

With their advanced inverter technology, ESAB's portable and transportable machines provide all the cutting power that normally requires larger, heavyweight consoles.

The versatile Deuce Pack 150 system offers 300A of heavy-duty cutting and gouging power for a variety of industrial applications - plus it can be separated into two 150A consoles for smaller scale operations. Also available are a variety of advanced ESP (ESAB Smart Plasma) heavy mechanized systems for high quality cutting in automated applications.

ESAB's commitment to plasma performance is carried through in the high quality Plasmarc torches and consumables. From the innovative PT-31XL, the most compact 50A torch available on the market with the capacity to cut up to 1 in. (25.4 mm), to the PT-26, with a 4 in. (101.6 mm) cutting capacity with air, N₂ or H-35, shielding gas, our torches are designed for superior cut quality and maximum operator comfort. And ESAB's patented XT tips boost performance and extend consumable life.

Plasmarc gouging outperforms other conventional gouging methods. Because it produces substantially less smoke and fumes, it significantly decreases operator exposure to air contaminants. In addition, Plasmarc gouging is faster, cleaner, less expensive, and more accurate than other gouging processes.

Process Description

In our patented Plasmarc process, an electrode is built into the torch nozzle, which has an arc constricting orifice. Plasma gas, usually air, is fed through the nozzle where it is heated to the plasma temperature range - as high as 50,000°F (27,760°C). The plasma arc that emerges from the orifice is hot enough to melt any metal.

Because Plasmarc cutting is a relatively simple operation, it is widely accepted for cutting ferrous and non-ferrous metals. The plasma arc's straight, narrow, column-like shape and high current density allow the operator to achieve cut consistency without maintaining a constant distance between the nozzle and the workpiece.

Plasmarc gouging is a variation of the Plasmarc cutting process. The torch nozzle configuration is designed to produce a lower velocity, broader arc. Rather than cutting completely through the metal, the torch is held at an angle so the arc gouges a U-shaped groove in the metal.

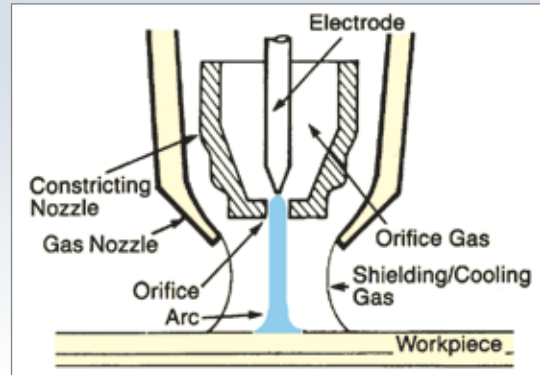

Plasma Arc Cutting

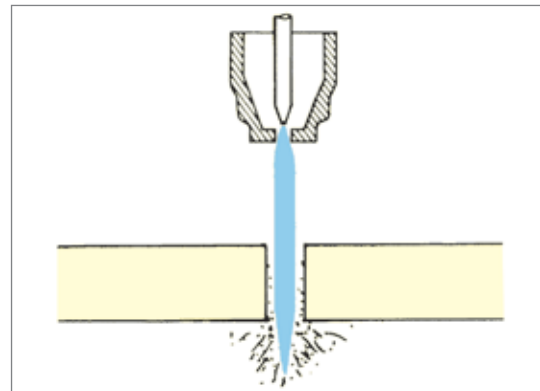

Plasma Arc Gouging

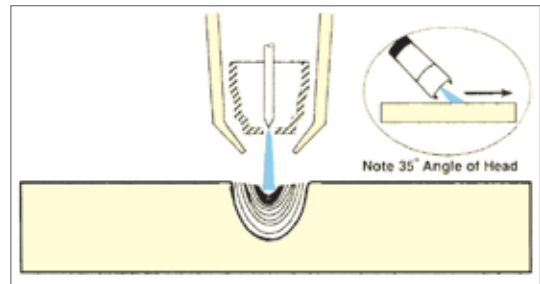

Plasma Arc Cutting

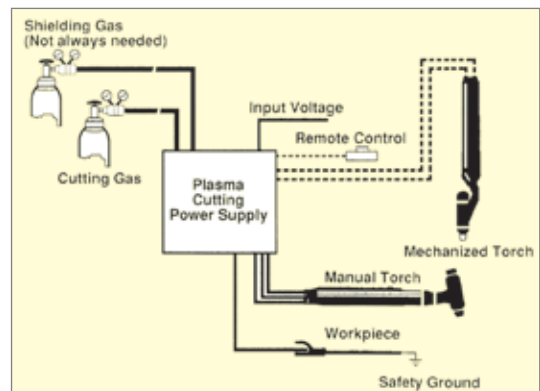

Plasmarc cutting involves using a torch, compressed gas, and a source of electric power to create a constricted arc that melts a localized area of metal and removes the molten material with a high-velocity jet of hot, ionized gas.

During Plasmarc cutting, a compressed gas and an electric arc are simultaneously passed through a small orifice, which is typically 0.040 in. (1.0 mm) to 0.125 in. (3.18 mm) in diameter. An electric arc heats the gas to a plasma state at a temperature as high as 50,000°F (27,760°C). This super-heated plasma jet is directed to the area to be cut, and the jet melts a path through the metal. Because it is a melting process, a Plasmarc can cut almost any commercially used metal.

Plasmarc cutting can be accomplished manually or mechanically. In mechanical setups, a Plasmarc torch is driven by an automatic machine that is typically regulated by a computer numerical control (CNC) to cut a predetermined shape. This article focuses on manual Plasmarc cutting, in which the Plasmarc torch is manipulated by hand to perform a variety of metal cutting tasks.

Manual systems are available in a variety of sizes. Generally rated in amperage output or cutting capacity, the units range from about 15 to 300A output, encompassing a cutting capacity ranging from 1/4 in. (6.35 mm) to approximately 4 in. (101.6 mm).

Manual units can also be divided into two general categories. Stationary or console systems generally are designed to remain fixed in one place, although most are equipped with wheels that make it possible to move them around a shop. Portable systems are designed to be carried around by one or two workers, allowing them to move the system where it is needed rather than taking materials to be cut to one location.

Most of these systems use ordinary shop compressed air as the plasma cutting gas, provided it is not too wet, dirty, or oily. Some systems can also use other compressed gases such as Nitrogen or Argon/Hydrogen mixtures for certain cutting tasks involving non-ferrous metals.

Typical Cutting Needs

In most sheet metal shops, a variety of metal cutting chores must be accomplished, and the need often arises to cut unique or low-production shapes, modify a part, do prototype work, or modify a part in the field. Several options besides plasma cutting are available to accomplish these cutting tasks. “Nibblers” are relatively inexpensive and can cut shapes and contours. They may run slow on thicker materials, however, and they may distort the metal or leave scalloped or rough edges.

“Shears” are quick and leave a smooth edge, but they are restricted to cutting straight edges. Similarly, circular saws leave reasonably good quality straight edges, but they are limited to cutting straight lines. Saber saws are not limited to cutting straight lines, but they may run slower and are most suitable for thinner materials.

Oxyfuel cutting may not be suitable for use on gauge-thickness materials because the preheating that is necessary, and relatively low travel speeds, combine to place a considerable amount of heat in the steel, which can cause severe distortion of thinner materials. It is also limited to use on carbon steel, because other metals create high melting point oxides that interfere with or stop the burning process of oxyfuel cutting. However, oxyfuel cutting is considered a better choice for cutting carbon steel thicknesses of more than 1-1/2 in. (38 mm) because it is faster.

The travel speed of oxyfuel is determined by the propagation rate of the burning reaction, which is relatively independent of the steel thickness. Typically, it is in the range of 20-25 ipm (508-635 mm/min). Plasma melts its way through a material, however, so the cutting speed is determined by material types and thicknesses. Typical plasma cutting speeds can range from 5-100+ ipm (127-2540+ mm/min).

An appropriately sized manual Plasmarc cutting unit can handle most cutting chores. The unit can cut contours and straight lines. Most units can follow a template or straight edge, so cutting does not necessarily have to be entirely freehand. In addition, circle cutting or other torch-guide attachments can aid in cutting particular contours. If a Plasmarc unit is sized properly for a job, cutting speeds should be about 15 ipm (381 mm/min) or higher, which helps maintain good production rates while minimizing heat distortion of a workpiece. The resulting edge quality can vary, however, depending on the particular plasma unit being used, the material being cut, and the operator’s skill. Typically, using air as the plasma gas while cutting carbon steel helps produce straight and relatively smooth edges. Any slag or dross that accumulates on the bottom of a cut knocks off easily. Air can also be used as the plasma gas for cutting stainless steel and aluminum, but some oxidation will occur on the resulting edges. Aluminum develops a rough appearance, and stainless steel becomes somewhat discolored. However, using an inert gas such as Nitrogen or Argon/Hydrogen instead of air as the plasma gas can eliminate these problems.

For cutting chores beyond the gauge thickness range, manual plasma is often a suitable choice. Plasmarc cutting units can cut, trim, or remove carbon steel as thick as 4 in. (101.6 mm).

Plasmarc® Processes

Plasma uses no open flame, and no compressed gas cylinders are needed if air is used as the plasma gas. Still, oxyfuel cutting is usually considered to be a better choice for carbon steel thicknesses of more than 1/2 to 2 in. (12.7 to 50.8 mm) because of its speed.

For thicker stainless steels, as well as cast iron and high-alloy steels, plasma cutting may be the only practical cutting option. The tough composition of stainless steels makes cutting them by mechanical means difficult. Again, if the cut face must not be discolored or oxidized, gases such as Nitrogen or Argon/Hydrogen should be used instead of air.

Cutting Capability

Choosing the right manual plasma unit for your particular application can be perplexing if you are unfamiliar with manual plasma cutting. Once you understand the basics, however, the job becomes easy. No industry standard exists for rating the thickness cutting capability of a manual plasma unit. However, cutting thickness claims made by most major manufacturers are usually accurate.

First, determine the maximum thickness you plan to cut regularly. This thickness should be in the mid-range of the unit's cutting capability. This is important because:

1. When tackling their maximum cutting thicknesses, most manual plasma units have slow travel speeds, typically less than 12 ipm (304.8 mm/min).
2. The higher cutting current of a larger-rated unit inhibits dross or slag formation on the bottom of the cut on carbon steel, producing a cleaner cut.
3. The reserve cutting capacity provides the capability to cut thicker materials if the need arises.

Be careful to judge a unit by its actual cutting capability and not by its electrical current rating, because different designs deliver dissimilar cutting performances from the same amount of current. You should also remember that most cut thickness ratings are based on cutting carbon steel.

Another consideration in selecting a unit is portability. Most units available with 1 in. (25.4 mm) or lower capacities are designed so that one or two workers can transport them around a plant or job site.

Most plasma arc cutting units rated at more than 1 in. (25.4 mm) capacity cannot be transported easily, but they may be wheeled about a shop or transported with a lift truck or hoist.

The Cutting Torch

One of the most important considerations in choosing a system is the front-end design of the plasma arc cutting torch, because it controls the cut and most heavily influences the operating costs of the setup. If reaching tight places is important, a torch with a small or narrow front end is a good choice. A smaller front end may also be a better choice in applications that require a clear line of vision to follow a cut line, because a larger front end could obscure vision.

In addition to the up-front costs for nozzles, electrodes, and other front-end parts, you should consider the durability of the parts and the life in arc hours you can expect from the nozzle and electrode combination. These factors are better indicators of operating costs than are the prices of the parts alone.

Plasmarc cutting torch parts are generally made to very high tolerances. Make sure that any replacement parts you use are made to proper specifications. The wrong replacement parts can result in poor performance and damage to the torch head, which could require an expensive repair.

Recommended Cutting Gases

Compressed Air is the most commonly used gas for lower current plasma cutting and works well for most metals from gauge thickness to 1 in. (25.4 mm). It leaves an oxidized cut surface. Compressed air can also be used for plasma gouging on carbon steel.



Nitrogen (N₂) is often used for higher current plasma systems and for cutting materials up to 3 in. (76.2 mm) thick. It produces excellent quality cuts on most materials.

Oxygen (O₂) is used when the highest quality mechanized cuts are desired on carbon steel up to 1-1/4 in. (31.75 mm) thick. The cut face is smooth, and dross is easy to remove. Oxygen can also be used on stainless steel and aluminum, but it produces a rougher cut face.

Argon-Hydrogen Mixtures (H-35) are generally used for cutting stainless steel and aluminum. They produce a clean, high quality cut face. Argon-Hydrogen is required for mechanized cutting of any material more than 3 in. (76.2 mm) thick. This mixture also provides an excellent gas for plasma gouging on all materials.

Finally, the best way to evaluate a manual Plasmarc cutter for your application is to ask for a demonstration. Many of the factors that determine which unit is right for you become obvious when you see the unit demonstrated in your own shop. Pay particular attention to cut speed, quality, ease of use, and portability, if that is an issue. If access is limited to an area to be cut, make sure that the cutter you evaluate can do the job.

Icon Key

	Designates equipment configured for manual plasma
	Designates equipment configured for mechanized plasma
1Phase	Designates equipment requiring 1-phase input power
3Phase	Designates equipment requiring 3-phase input power
1Phase 3Phase	Designates equipment that uses 1- or 3-phase input power



Important Product Safety

Sound common sense procedures must be followed for personal protection and operating efficiency when using arc welding equipment. Always comply with the manufacturer's recommendations for operating and maintaining the equipment, as set forth in the instructions provided with each unit. Also, be certain to use all applicable safety precautions, as described in *Precautions and Safe Practices for Arc Welding, Cutting and Gouging*, #F-52-529, which is available by contacting ESAB at 1-800-ESAB.123 or visiting esabna.com.

Plasmarc®

Equipment Selection Guide

Model	Output Current, A	Gouging ¹	Piercing ²	Input Voltage	Duty Cycle, %	Torch	Rated Cut Capacity, in. (mm) ³	Gas Type	Cooling Method	Lengths Available, ft. (m)	Torch Head Angle	Typical Applications	Recommended Generator Power
PowerCut 400	15-30	●		110/230V 1ph	20	PT-39	3/8 (9.5)	Air	Gas	15 (4.5) 25 (7.6)	90°	HVAC, Auto Body, Plumbing, Farming & Ranching, Maintenance	6kW
PowerCut 700	30-50	●		208/230V 1ph	25	PT-39 PT-37	5/8 (15.9)	Air	Gas	25 (7.6) 50 (15.2)	90°	HVAC, Auto Body, Plumbing, Farming & Ranching, Maintenance	10kW
PowerCut 900	10-60	●	●	208/230/460/575V 1/3ph	60	PT-38 PT-37	7/8 (22)	Air	Gas	25 (7.6) 50 (15.2)	90°	Construction, Maintenance and Repair, Fabrication, Gouging	10.8kW
PowerCut 1300	20-70	●	●	208/230/460/575V 1/3ph	60	PT-38 PT-37	1-1/4 (32)	Air	Gas	25 (7.6) 50 (15.2)	90°	Construction, Maintenance and Repair, Fabrication, Gouging	12.4kW
PowerCut 1600	20-90	●	●	208/230/460/575V 1/3ph	40	PT-38 PT-37	1-1/2 (38)	Air	Gas	25 (7.6) 50 (15.2)	90°	Construction, Maintenance and Repair, Fabrication, Gouging	16.5kW
ESP-101	25-100	●	●	208/230/460/575V 1/3ph	100	PT-37	1-1/4 (32)	Air	Gas	Various	In-line	Track Cutting and Back Gouging, XY Table Cutting, Pipe cutting	16.5kW
ESP-150	30-150	●	●	208/230/460/575V 3ph	90	PT-26 PT-19XLS PT-36R	2 (50.8)	Air N ₂ O ₂ H-35	Fluid	Various	70° 90° In-line	Heavy Fabrication, Heavy Maintenance & Repair, Demolition & Scraping, Heavy Gouging	46kW
Deuce Pack 150	30-300	●	●	208/230/460/575V 3ph	90	PT-26 PT-19XLS PT-36R	4 (101.6)	Air N ₂ O ₂ H-35	Fluid	Various	70° 90° In-line	Foundries, Heavy Maintenance & Repair, Demolition & Scraping, Heavy Gouging	92kW
m ³ Plasma Systems	30-720		●	208/230/460/575V 3ph	100	PT-36	6 (150)	Air N ₂ O ₂ H-35	Fluid	Various	In-line	High Volume Automated Cutting	-

¹Gouging capability allows customers to perform gouging applications such as weld removal, repair, and back gouging.

Not all plasma machines in the market are suitable for gouging. They lack the necessary design attributes to offer this feature.

²Piercing is rated by half of the machine's rated capability. This is to give as much protection as possible to the life of consumables.

Proper technique can be found in the machine's instruction manual.

³The rated cut capacity chart is designed to help customers choose the machine that best fits their applications.

Rated cut capacity is based on travel speeds between 10 - 15 ipm giving you a desirable cut face at an acceptable speed.

Plasmarc Cutting Package Capabilities

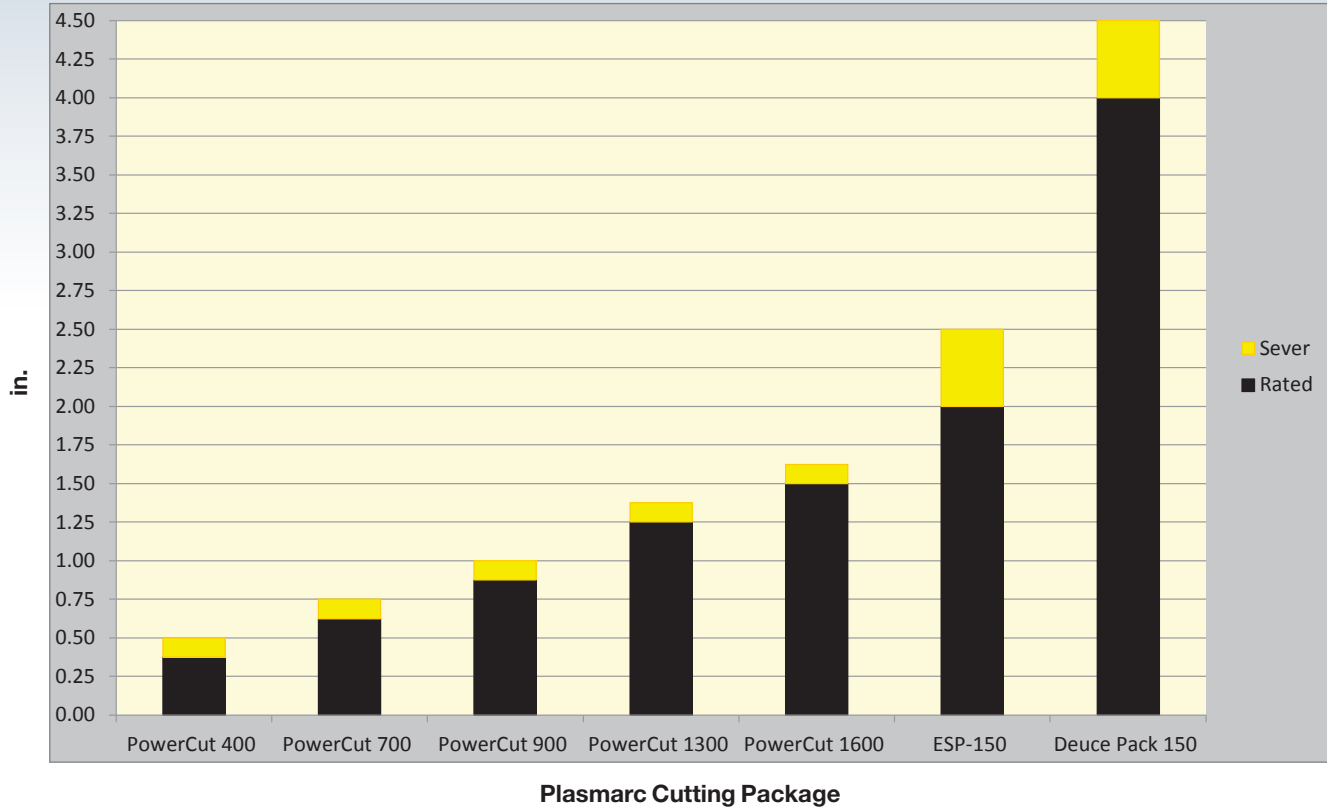

Plasma
Equipment

PowerCut® 400



Designed with ESAB Plasmarc technology, PowerCut machines are more powerful and durable than any other machine in their class.

PowerCut makes plasma cutting easier and more economical, delivering reliability, high production, and a wide variety of performance features to simplify operations, reduce set-up time and enhance consumable life, so you spend less time troubleshooting and more time cutting.

- **Manually cuts 3/8 in. (9.5 mm) and severs 1/2 in. (12.7 mm) - powerful cutting performance**
- **Compact, lightweight design for easy transport**
- **Adaptable voltage - adapt to 110V or 230V by simply changing the adaptor plugs provided**
- **Blowback technology eliminates high-frequency startups that can disrupt CNC controls and nearby computer systems**
- **Dynamic arc control - control the pilot arc when you need to cut grate or mesh material without arc outage**
- **Compatible to work with generators when power is not accessible in the field**
- **Ergonomic, lightweight torch handle design provides maximum comfort when tackling tough jobs**
- **Compact torch design with shorter front end allows maximum arc visibility in those hard-to-reach places**
- **Automatic air pressure - PowerCut 400 automatically sets your air pressure for you**
- **Voltage booster is useful for finishing off thick material with ease and also ideal for the inexperienced operator to cut in confidence**
- **Drag cutting capable - great for template cutting, straight edge cutting, and first time users**
- **Arrives fully assembled, ready to cut out of the box**
- **One-year warranty on torch**



Ordering Information

Ready to Cut Packages with PT-39 Torch

- PowerCut 400, 120-230V, 15 ft. (4.5 m)..... 0558011649
- PowerCut 400, 120-230V, 25 ft. (7.6 m)..... 0558011671

Includes: console, PT-39 torch, torch spare parts kit, 110V/230V adaptor plugs, power cord, work cable with clamp. System arrives fully assembled and ready to cut.

Options & Accessories

- PT-39 replacement torch, 15 ft. (4.5 m) 0558010576
- PT-39 replacement torch, 25 ft. (7.6 m) 0558010577
- 30A spare parts kit, PT-39 0558010583
- Plasma flow measuring kit 0558000739

Torch Guide Kits

- Deluxe: 1-3/4 in. (44.5 mm) 42 in. (106 cm) radius... 0558003258
- Basic: 1-3/4 in. (44.5 mm) 28 in. (71 cm) radius .. 0558002675

Drag heat shield 0558010581

Optional Five-Year Warranty

PowerCut 400 extended warrantyXWPC400

Specifications

PowerCut 400	
Cuts, in. (mm)	3/8 (9.5)
Severs, in. (mm)	1/2 (12.7)
Output	30A @ 20% duty cycle
Input	110-230V, 1ph, 50/60Hz, 22A
Recommended engine driven generator power	6kW
Power factor	99%
Air requirements, cfm @ psig (L/min @ bar)	300 @ 70 (141 @ 4.8)
Dimensions, LxWxH, in. (mm)	18.3x 6.3x 13.4 (464x160x340)
Weight, lbs. (kg)	32 (15)

Cut Speed Chart (30A)

Thickness		Cut Speeds		
in.	mm	ipm	mm/min	
14 gauge	1.6	240	6,096	Recommended
0.125	3.1	140	3,556	
0.25	6.3	47	1,194	
0.375	9.5	25	635	Max.
0.5	12.7	10	254	
.075	19	4	101	



PowerCut® 700



Designed with ESAB Plasmarc technology, PowerCut machines are more powerful and durable than any other machine in their class.

PowerCut makes plasma cutting easier and more economical, delivering reliability, high production, and a wide variety of performance features to simplify operations, reduce set-up time, and enhance consumable life, so you spend less time troubleshooting and more time cutting.

- **Manually cuts 5/8 in. (15.9 mm) and severs 3/4 in. (19.0 mm) - powerful cutting performance**
- **Compact, lightweight design for easy transport**
- **Tool-less quick disconnect torch disconnects from the machine without the use of wrenches or special tools; easily disconnect your PT-39 for repairs or replacement, or to attach a PT-37 mechanized torch for mechanized applications**
- **Blowback technology eliminates high-frequency startups that can disrupt CNC controls and nearby computer systems**
- **Compatible to work with generators when power is not accessible in the field**
- **Lightweight, ergonomic torch handle design provides maximum comfort when tackling tough jobs**
- **Compact torch design with shorter front end allows maximum arc visibility in those hard-to-reach places**
- **Voltage booster - useful for finishing off thick material with ease and ideal for the inexperienced operator to cut in confidence**
- **Drag cutting capable - great for template cutting, straight edge cutting, and first time users**
- **Grate cutting mode for maximized productivity when cutting grate or mesh material**
- **Arrives fully assembled, ready to cut out of the box**
- **One-year warranty on torch**

Cut Speed Chart (50A)

Thickness		Cut Speeds		
inches	millimeters	ipm	mm/min	
14 gauge	1.6	350	8,890	Recommended
0.125	3.1	225	5,715	
0.25	6.3	83	2,108	
0.375	9.5	44	1,117	
0.5	12.7	31	787	
0.625	15.8	20	508	
0.75	19	15	381	Max.
1	25.4	10	254	



Ordering Information

Ready to Cut Packages with PT-39 Torch

- PowerCut 700, 208-230V, 25 ft. (7.6 m)..... 0558011673
- PowerCut 700, 208-230V, 50 ft. (15.2 m)..... 0558011674

Includes: console, PT-39 torch, torch spare parts kit, air filter, regulator, power cord, work cable with clamp. System arrives fully assembled and ready to cut.

Options & Accessories

- PT-39 replacement torch, 25 ft. (7.6 m) 0558011580
- PT-39 replacement torch, 50 ft. (15.2 m) 0558011581
- 50A spare parts kit, PT-39 0558010584
- Plasma flow measuring kit 0558000739

Torch Guide Kits

- Deluxe: 1-3/4 in. (44.5 mm) 42 in. (106 cm) radius... 0558003258
- Basic: 1-3/4 in. (44.5 mm) 28 in. (71 cm) radius .. 0558002675

- Remote hand switch, 25 ft. (7.6 m)..... 0558008349
- Drag heat shield 0558010581
- Mechanized interface kit..... 0700210200

Optional Five-Year Warranty

- PowerCut 700 extended warrantyXWPC700

Specifications

PowerCut 700	
Cuts, in. (mm)	5/8 (15.9)
Severs, in. (mm)	3/4 (19.0)
Output	50A @ 25% duty cycle 30A @ 100% duty cycle
Input	208/230V, 1ph, 50/60Hz, 41A
Recommended engine driven generator power	10.8kW
Power factor	75%
Air requirements, cfm @ psig (L/min @ bar)	400 @ 70 (189 @ 5.5)
Dimensions, LxWxH, in. (mm)	22x15x8.3 (558x380x210)
Weight, lbs. (kg)	47 (22)



PowerCut® 900



Designed with ESAB Plasmarc technology, PowerCut machines are more powerful and durable than any other machine in their class.

PowerCut makes plasma cutting easier and more economical, delivering reliability, high production, and a wide variety of performance features to simplify operations, reduce set-up time and enhance consumable life, so you spend less time troubleshooting and more time cutting.

- **Durable external housing design is damage-resistant, corrosion-resistant, and weather-resistant, while remaining lightweight for portability**
- **Tool-less quick disconnect torch disconnects from the machine without the use of wrenches or special tools; easily disconnect your PT-38 torch for storage, repairs or replacement, or to attach a PT-37 mechanized torch for mechanized applications**
- **Easy-to-read digital display shows the exact pressure or amperage and help codes to assist in troubleshooting minor errors and reducing downtime, so you can operate with confidence**
- **Blowback technology eliminates high-frequency startups that can disrupt CNC controls and nearby computer systems**
- **Switch between modes automatically (gouge, grate, and normal modes), tailoring your application without manually changing settings on the console**
- **Sensitive internal electronics are suspended from the aluminum frame, insulating them from shock and vibration**
- **Silicone-sealed switches are immune to corrosion, as well as dust and dirt infiltration**
- **PowerCut delivers the extra output voltage needed for superior plasma gouging capability**
- **Automatic fan control - the cooling fan is automatically controlled to run only when necessary, conserving energy and reducing ingested dust and dirt**
- **Built-in power line conditioner protects against damage from power line noise and spikes, even with poor-quality power**
- **Torch wrap and spare parts kit holder lets you neatly fold up excess torch cables for convenient storage in your consumable box**
- **“Plug-n-Play” mechanized option lets you easily transform your manual cutting system into a powerful mechanized system for your gantry machine**
- **One-year warranty on torch**



Ordering Information

Ready to Cut Packages with PT-38 Torch

PowerCut 900, 208-230V, 25 ft. (7.6 m)	0558008121
PowerCut 900, 208-230V, 50 ft. (15.2 m)	0558008122
PowerCut 900, 460V, 25 ft. (15.2 m)	0558008128
PowerCut 900, 460V, 50 ft. (7.6 m)	0558008129
PowerCut 900, 575V, 25 ft. (7.6 m)	0558008132

Includes: console, PT-38 torch, torch spare parts kit, air filter, regulator, power cord, 25 ft. (7.6 m) work cable with clamp. System arrives fully assembled and ready to cut.

Standard Console with PT-37 Mechanized Torch

PowerCut 900, mechanized, 25 ft. (7.6 m)	0558008143
PowerCut 900, mechanized, 50 ft. (15.2 m)	0558008144

Includes: remote hand switch and rack.

PowerCut 900 Packages with CNC Interface

208-230V, PT-37, 25 ft. (7.6 m) with rack	0558009206
208-230V, PT-37, 50 ft. (15.2 m) with rack	0558009207
208-230V, PT-37, 25 ft. (7.6 m)	0558009208
208-230V, PT-37, 50 ft. (15.2 m)	0558009209
460V, PT-37, 25 ft. (7.6 m).....	0558009212
460V, PT-37, 50 ft. (15.2 m).....	0558009213
575V, PT-37, 25 ft. (7.6 m) with rack.....	0558009218
575V, PT-37, 50 ft. (15.2 m) with rack.....	0558009219
575V, PT-37, 25 ft. (7.6 m).....	0558009220
575V, PT-37, 50 ft. (15.2 m).....	0558009221
230V CE, PT-37, 25 ft. (7.6 m).....	0558009222
230V CE, PT-37, 50 ft. (15.2 m).....	0558009223
400V CE, PT-37, 25 ft. (7.6 m).....	0558009224
400V CE, PT-37, 50 ft. (15.2 m).....	0558009225
400V, PT-37, 25 ft. (7.6 m).....	0558009228
400V, PT-37, 50 ft. (15.2 m).....	0558009229
208-230V, PT-38, 25 ft. (7.6 m)	0558008145
208-230V, PT-38, 50 ft. (15.2 m)	0558008146

Includes: torch holder, spare parts kit and CNC interface cable. Note: “CE” items are used outside North America. All packages do not include racks unless otherwise indicated.

Options & Accessories

60A spare parts kit, PT-38 0558008418
 Plasma flow measuring kit 0558000739

Torch Guide Kits

Deluxe: 1-3/4 in. (44.5 mm) 42 in. (106 cm) radius.. 0558003258
 Basic: 1-3/4 in. (44.5 mm) 28 in. (71 cm) radius . 0558002675

Remote hand switch, 25 ft. (7.6 m)..... 0558008349
 Stand-off guide..... 0558008592
 40A drag nozzle 0558007682
 Utility cart..... 0558007898
 Gouging heat shield 0558008591
 Gouging nozzle..... 0558008588
 CNC cable interface, 50 ft. (15.2 m) 57002249
 Plug-n-Play mechanized kit..... 0558008284
 Heavy-duty water separator 0558007897

PT-37 Replacement Torches

With rack 4.5 ft. (1.3 m) 0558004860
 With rack 17 ft. (5.2 m) 0558004861
 With rack 25 ft. (7.6 m) 0558004862
 With rack 50 ft. (15.2 m) 0558004863
 Without rack 4.5 ft. (1.3 m) 0558004894
 Without rack 17 ft. (5.2 m) 0558004895
 Without rack 25 ft. (7.6 m) 0558004896
 Without rack 50 ft. (15.2 m) 0558004897

PT-38 Replacement Torches

25 ft. (7.6 m) 0558006786
 50 ft. (15.2 m) 0558006787

Optional Five-Year Warranty

PowerCut 900 extended warrantyXWPC900

Specifications

PowerCut 900	
Cuts, in. (mm)	7/8 (22)
Severs, in. (mm)	1-1/4 (32)
Output	60A @ 60% duty cycle 50A @ 100% duty cycle
Input	208/230V, 1ph, 50/60Hz, 56/47A 208/230/400/460/575V, 3ph, 50/60Hz, 28/23/13/12/9A
Recommended engine driven generator power	1 phase 230V = 11kW 3 phase 460V = 9.7kW 3 phase 575V = 10kW
Air requirements, cfm @ psig (L/min @ bar)	400 @ 80 (165 @ 4.8-5.2)
Dimensions, LxWxH, in. (mm)	25.3x12.3x14.2 (643x312x361)
Weight, lbs. (kg)	71 (32)

Cut Speed Chart (60A)

Thickness		Cut Speeds		
in.	mm	ipm	mm/min	
0.125	3.1	140	3,556	Recommended.
0.25	6.3	47	1,194	
0.375	9.5	25	635	
0.5	12.7	10	254	
0.625	15.8	25	635	
0.75	19	4	101	
1	25.4	12	304	Max.



PowerCut® 1300

1Phase 3Phase **3** YEAR WARRANTY 100% SATISFACTION GUARANTEED

PowerCut makes plasma cutting easier and more economical, delivering reliability, high production, and a wide variety of performance features to simplify operations, reduce set-up time, and enhance consumable life, so you spend less time troubleshooting and more time cutting.

- **Rugged design - durable external housing design is damage-resistant, corrosion-resistant, and weather-resistant, while remaining lightweight for portability**
- **Input voltage selector switch - conveniently located on back of the machine, lets you easily change input voltage from 208V to 460V**
- **Tool-less quick disconnect torch disconnects from machine for storage, repairs, or replacement without the use of wrenches or special tools, or to attach a PT-37 mechanized torch**
- **Digital readout display is easy to read and shows exact pressures or amperage and help codes to assist in troubleshooting**
- **Switch between gouge, grate, and normal modes automatically, tailoring your application without manually changing settings on console**
- **Delivers the extra output voltage needed for superior plasma gouging capability**
- **Torch wrap and spare parts kit holder is standard on all packages**
- **Blowback technology eliminates high-frequency startups that can disrupt CNC controls and nearby computer systems**
- **Sensitive internal electronics are suspended from the aluminum frame, insulating them from shock and vibration**
- **Silicone-sealed switches are immune to corrosion and dust and dirt infiltration**
- **Automatic fan control allows cooling fan to run only when necessary - conserves energy and reduces ingested dust and dirt**
- **Built-in power line conditioner protects against damage from power line noise and spikes, even with poor-quality power**
- **“Plug-n-Play” mechanized option lets you easily transform your manual cutting system into a powerful mechanized system for your gantry machine**
- **One-year warranty on torch**



Plasma Equipment



Ordering Information

Ready to Cut Packages with PT-38 Torch

PowerCut 1300, 208-230/460V, 25 ft. (7.6 m) . 0558007221
 PowerCut 1300, 208-230/460V, 50 ft. (15.2 m) 0558007222
 PowerCut 1300, 575V, 25 ft. (7.6 m) 0558007228
 PowerCut 1300, 575V, 50 ft. (15.2 m) 0558007229

Includes: console, PT-38 torch, torch spare parts kit, air filter, regulator, power cable, 25 ft. (7.6 m) work cable with clamp. System arrives fully assembled and ready to cut.

Standard Console with PT-37 Mechanized Torch, 230/460V

PowerCut 1300, mechanized, 25 ft. (7.6 m) 0558008178
 PowerCut 1300, mechanized, 50 ft. (15.2 m) .. 0558008179

Includes: remote hand switch and rack.

PowerCut 1300 Packages with CNC Interface

230/460V, PT-37, 25 ft. (7.6 m) 0558008170
 230/460V, PT-37, 50 ft. (15.2 m) 0558008171
 230/460V, PT-37, 25 ft. (7.6 m) with rack 0558008172
 230/460V, PT-37, 50 ft. (15.2 m) with rack 0558008173
 575V, PT-37, 25 ft. (7.6 m) with rack..... 0558009198
 575V, PT-37, 50 ft. (15.2 m) with rack..... 0558009199
 230/460V, PT-38, 25 ft. (7.6 m) 0558008182
 230/460V, PT-38, 50 ft. (15.2 m) 0558008183

Includes: torch holder, spare parts kit, and CNC interface cable.

Options & Accessories

70A spare parts kit, PT-38 0558007641
 Plasma flow measuring kit 0558000739

Torch Guide Kits

Deluxe: 1-3/4 in. (44.5 mm) 42 in. (106 cm) radius. 0558003258
 Basic: 1-3/4 in. (44.5 mm) 28 in. (71 cm) radius 0558002675

Remote hand switch, 25 ft. (7.6 m) 0558008349
 Stand-off guide 0558006614
 40A drag nozzle 0558007682
 Utility cart 0558007898
 Gouging heat shield 0558008186
 Gouging nozzle 0558007681
 CNC cable interface 30 ft. (9 m) 57002248
 Plug-n-Play mechanized kit 0558007885
 Heavy-duty water separator 0558007897

PT-37 Replacement Torches

With rack 4.5 ft. (1.3 m) 0558004860
 With rack 17 ft. (5.2 m) 0558004861
 With rack 25 ft. (7.6 m) 0558004862
 With rack 50 ft. (15.2 m) 0558004863
 Without rack 4.5 ft. (1.3 m) 0558004894
 Without rack 17 ft. (5.2 m) 0558004895
 Without rack 25 ft. (7.6 m) 0558004896
 Without rack 50 ft. (15.2 m) 0558004897

PT-38 Replacement Torches

25 ft. (7.6 m) 0558006786
 50 ft. (15.2 m) 0558006787

Optional Five-Year Warranty

Powercut 1300 extended warranty XWPC1300

Specifications

PowerCut 1300	
Cuts, in. (mm)	1-1/4 (32)
Severs, in. (mm)	1-1/2 (38)
Output	70A @ 60% duty cycle, 1ph 70A @ 100% duty cycle, 3ph
Input	208/230V, 1ph, 50/60Hz, 70/60A 208/230/400/460/575V, 3ph, 50/60Hz, 36/31/18/20/15A
Recommended engine driven generator power	230V, 1ph = 14kW 230V, 3ph = 12.5kW 460V, 3ph = 16kW 575V, 3ph = 16kW
Air requirements, cfm @ psig (L/min @ bar)	400 @ 80 (165 @ 4.8-5.2)
Dimensions, LxWxH, in. (mm)	27.8x12.7x14.9 (706x323x378)
Weight, lbs. (kg)	90 (41)

Cut Speed Chart (70A)

Thickness		Cut Speeds		
in.	mm	ipm	mm/min	
0.125	3.1	140	3,556	Recommended.
0.25	6.3	47	1,194	
0.375	9.5	25	635	
0.5	12.7	10	254	
0.625	15.8	25	635	
0.75	19	4	101	
1	25.4	12	304	
1.25	31	10	254	
1.5	38	5	127	Max.



PowerCut® 1600

1Phase 3Phase **3** YEAR WARRANTY 100% SATISFACTION GUARANTEED

PowerCut makes plasma cutting easier and more economical, delivering reliability, high production, and a wide variety of performance features to simplify operations, reduce set-up time, and enhance consumable life, so you spend less time troubleshooting and more time cutting.

- **Rugged design - durable external housing design is damage-resistant, corrosion-resistant and weather-resistant, while remaining lightweight for portability**
- **Input voltage selector switch - conveniently located on back of the machine, lets you easily change input voltage from 208V to 460V**
- **Tool-less quick disconnect torch disconnects from machine for storage, repairs, or replacement without the use of wrenches or special tools, or to attach a PT-37 mechanized torch**
- **Digital readout display is easy to read and shows exact pressures or amperage as well as help codes to assist in troubleshooting**
- **Switch between gouge, grate, and normal modes automatically, tailoring your application without manually changing settings on console**
- **Delivers the extra output voltage needed for superior plasma gouging capability**
- **Torch wrap and spare parts kit holder is standard on all packages**
- **Blowback technology eliminates high-frequency startups that can disrupt CNC controls and nearby computer systems**
- **Sensitive internal electronics are suspended from the aluminum frame, insulating them from shock and vibration**
- **Silicone-sealed switches are immune to corrosion and dust and dirt infiltration**
- **Automatic fan control allows cooling fan to run only when necessary – conserves energy and reduces ingested dust and dirt**
- **Built-in power line conditioner protects against damage from power line noise and spikes, even with poor-quality power**
- **“Plug-n-Play” mechanized option lets you easily transform your manual cutting system into a powerful mechanized system for your gantry machine**
- **One-year warranty on torch**



Ordering Information

Ready to Cut Packages with PT-38 Torch

PowerCut 1600, 208-230/460V, 25 ft. (7.6 m) . 0558007231
 PowerCut 1600, 208-230/460V, 50 ft. (15.2 m) 0558007232
 PowerCut 1600, 575V, 25 ft. (7.6 m) 0558007238
 PowerCut 1600, 575V, 50 ft. (15.2 m) 0558007239

Includes: console, PT-38 torch, torch spare parts kit, air filter, regulator, power cable, 25 ft. (7.6 m) work cable with clamp. System arrives fully assembled and ready to cut

Standard Console 230/460V with PT-37 Mechanized Torch

PowerCut 1600, mechanized, 25 ft. (7.6 m) 0558008180
 PowerCut 1600, mechanized, 50 ft. (15.2 m) .. 0558008181

Includes: remote hand switch and rack.

PowerCut 1600 Packages with CNC Interface

230/460V, PT-37, 25 ft. (7.6 m) 0558008174
 230/460V, PT-37, 50 ft. (15.2 m) 0558008175
 230/460V, PT-37, 25 ft. (7.6 m) with rack 0558008176
 230/460V, PT-37, 50 ft. (15.2 m) with rack 0558008177
 575V, PT-37, 25 ft. (7.6 m) with rack..... 0558009182
 575V, PT-37, 50 ft. (15.2 m) with rack..... 0558009183
 230/460V, PT-38, 25 ft. (7.6 m) 0558008184
 230/460V, PT-38, 50 ft. (15.2 m) 0558008185

Includes: torch holder, spare parts kit, and CNC interface cable.

Plasma Equipment



Options & Accessories

90A spare parts kit, PT-38 0558007639
 Plasma flow measuring kit 0558000739

Torch Guide Kits

Deluxe: 1-3/4 in. (44.5 mm) 42 in. (106 cm) radius. 0558003258
 Basic: 1-3/4 in. (44.5 mm) 28 in. (71 cm) radius 0558002675

Remote hand switch, 25 ft. (7.6 m)..... 0558008349
 Remote hand switch, 50 ft. (15.2 m)..... 0558009277
 Stand-off guide 0558006614
 40A drag nozzle 0558007682
 Utility cart..... 0558007898
 Gouging heat shield 0558008186
 Gouging nozzle 0558007681
 CNC cable interface, 30 ft. (9 m) 57002248
 Plug-n-Play mechanized kit 0558007885
 Heavy-duty water separator 0558007897

PT-37 Replacement Torches

With rack 4.5 ft. (1.3 m) 0558004860
 With rack 17 ft. (5.2 m) 0558004861
 With rack 25 ft. (7.6 m) 0558004862
 With rack 50 ft. (15.2 m) 0558004863
 Without rack 4.5 ft. (1.3 m) 0558004894
 Without rack 17 ft. (5.2 m) 0558004895
 Without rack 25 ft. (7.6 m) 0558004896
 Without rack 50 ft. (15.2 m) 0558004897

PT-38 Replacement Torches

25 ft. (7.6 m) 0558006786
 50 ft. (15.2 m) 0558006787

Optional Five Year Warranty

Powercut 1600 extended warrantyXWPC1600

Specifications

PowerCut 1600	
Cuts, in. (mm)	1-1/2 (38)
Severs, in. (mm)	1-3/4 (44)
Output	90A @ 40% duty cycle, 1ph 90A @ 60% duty cycle, 3ph
Input	230V, 1ph, 50/60Hz, 78A 208/230/400/460/575V, 3ph, 50/60Hz, 47/41/26/25/20A
Recommended engine driven generator power	230V, 1ph = 18kW 230V, 3ph = 16.5kW 460V, 3ph = 20kW 575V, 3ph = 21kW
Air requirements, cfm @ psig (L/min @ bar)	400 @ 80 (165 @ 4.8-5.2)
Dimensions, LxWxH, in. (mm)	27.8x12.7x14.9 (706x323x378)
Weight, lbs. (kg)	90 (41)

Cut Speed Chart (90A)

Thickness		Cut Speeds		
in.	mm	ipm	mm/min	
0.125	3.1	350	8,890	Recommended.
0.25	6.3	160	4,064	
0.375	9.5	95	2,413	
0.5	12.7	60	1,524	
0.625	15.8	46	1,168	
0.75	19	29	736	
1	25.4	19	482	
1.25	31	12	304	
1.5	38	8	203	Max.
1.75	44.4	5	127	



ESP-101



The ESP-101 is a multi-purpose, 100A plasma cutting system for mechanized cutting at 100% duty cycle for enhanced productivity allowing for continuous operation even at maximum thickness.

Uses ESAB's Smart Plasma concept to provide a plasma cutting console that is ideal for a variety of mechanized cutting applications.

Equipped with the patented PT-37 torch, this system cuts up to 1 in. (25.4 mm) using air as the plasma and shielding gas.

Utilizing a blowback start and an electronically controlled pilot arc, the PT-37 sets a new standard for starting reliability, cutting characteristics, and consumable life.

- Utilizes a “drawn arc” to initiate the cut, which eliminates high frequency interference from the starting circuits
- Electronically controlled pilot arc provides for consistent starting and longer consumable life
- Gouging mode allows for higher operating voltages at a reduced current for demanding mechanized plasma gouging applications, which require long arcs
- Full CNC/Robotic interface with Arc Voltage Height Control support is standard
- Adaptor plugs to match competitive system interface cables are available
- An optional remote starting system allows the torch to be located up to 150 ft. (45 m) away from the power supply
- Machined torch body with 1-3/8 in. (35 mm) metal handle, available with and without 32 pitch rack to fit industry standard torch holders
- Robust machined torch components provide for reliability, durability, and ease of maintenance
- Metal nozzle and shield stand up to the toughest cutting conditions
- Wear parts are available individually, in sets, and in value packs, which eases ordering and saves money
- One-year warranty on torch



Plasma Equipment

Ordering Information

All packages include console, torch, start-up kit, and control cable.

ESP-101 Packages, 208/230-240/575V, 3ph

ESP-101, PT-37, 25 ft. (7.6 m) WR.....	0558009454
ESP-101, PT-37, 50 ft. (15.2 m) WR.....	0558009455
ESP-101, PT-37, 25 ft. (7.6 m) NR	0558009456
ESP-101, PT-37, 50 ft. (15.2 m) NR	0558009457

460V console with TUA2 auto-transformer for 575V applications.

ESP-101 Packages, 460V, 3ph

ESP-101, PT-37, 25 ft. (7.6 m) WR.....	0558009450
ESP-101, PT-37, 50 ft. (15.2 m) WR.....	0558009451
ESP-101, PT-37, 25 ft. (7.6 m) NR	0558009452
ESP-101, PT-37, 50 ft. (15.2 m) NR	0558009453

ESP-101 Packages, 380-400V, 3ph, “CE”

ESP-101, PT-37, 25 ft. (7.6 m) WR.....	0558009458
ESP-101, PT-37, 50 ft. (15.2 m) WR.....	0558009459
ESP-101, PT-37, 25 ft. (7.6 m) NR	0558009461
ESP-101, PT-37, 50 ft. (15.2 m) NR	0558009462

For use in regions that require “CE” such as Europe, Russia, and Australia.

NR = torch with no rack. WR = torch with rack.

Options & Accessories

PT-37 Torches with Rack

4.5 ft. (1.3 m)	0558004860
17 ft. (5.2 m)	0558004861
25 ft. (7.6 m)	0558004862
50 ft. (15.2 m)	0558004863

PT-37 Torches without Rack

4.5 ft. (1.3 m)	0558004894
17 ft. (5.2 m)	0558004895
25 ft. (7.6 m)	0558004896
50 ft. (15.2 m)	0558004897

Control Methods

CNC cable 30 ft. (9 m)	57002248
CNC cable 50 ft. (15.2 m)	57002249

Remote Hand Switches

Remote hand switch, 25 ft. (7.6 m)	0558005548
Remote hand switch, 50 ft. (15.2 m)	0558005549

Remote Junction Box, Extension Hoses & Cables

Remote junction box (RJB)	0558004887
Hose/cable bundle RJB, 50 ft. (15.2 m)	0558004888
Hose/cable bundle RJB, 100 ft. (30 m)	0558004889

Torch holder, manually adjustable, 32 pitch rack ..	0558005926
Plate rider assembly	2238229

PT-37 Start Up Consumable Kits

100A	0558004883
70A	0558008247
60A	0558008248

PT-37 Consumable Sets

50A (1 nozzle, 1 electrode)	0558004884
100A (1 nozzle, 1 electrode)	0558004885
Value pack 100A (15 nozzles, 10 electrodes) ..	0558004886

Electrodes

100A	0558004875
50A	0558005220

Swirl Baffles

30-70A	0558005217
100A	0558004870

Nozzles

30A	0558005218
50A	0558004878
70A	0558005219
100A	0558004879

Nozzle Retainer	0558006600
-----------------------	------------

Shields

100A	0558006601
50-70A	0558006602
30-40A	0558006603



Specifications

ESP-101	
Cuts, in. (mm)	1 (25.4)
Output	100A @ 100% duty cycle, 3ph
Input	208/230/380/400/460/475/575V, 3ph, 20KVA, 50/60Hz, 54/49/29/28/25/24/20A
Air requirements, cfm @ psig (L/min @ bar)	500 @ 80 (236 @ 5.5)
Dimensions, LxWxH, in. (mm): ESP-101 380/400/460V ESP-101 208-575V	26.25x15.5x19.4(667x394x493) 26.25x15.5x35 (667x394x889)
Weight, lbs. (kg): ESP-101 380/400/460V ESP-101 208-575V	125 (56.7) 301 (136.5)

ESP-150



This multifaceted, all encompassed, heavy-duty, water-cooled plasma cutting and gouging system is ideal for manual and mechanized applications.

- **Greater productivity - high speed cutting of most metals from gauge thickness to 2 in. (51 mm) thick plate**
- **Versatility - 230/460/575V and 220/380/415V, 3ph inputs**
- **Greater variation - adjustable output from 25-150A**
- **Built-in water cooler - simplifies maintenance, less hookup, no wiring issues, no extra hoses; water flow is controlled with power supply**
- **Leather sheath wrapped torch - protects torch leads from abrasion and molten metal**
- **Cuts with air, Nitrogen, Argon/Hydrogen mixtures or Nitrogen/Hydrogen mixtures**
- **Built-in CNC interface provides easy connection of automation applications**
- **Torch design provides perfect electrode centering; provides longer tip life by minimizing the possibility of double-arcing**
- **Torch spare parts kit supplied with each outfit; ample supply of spare parts at no additional cost to minimize downtime**
- **Thermal overload switches - prevents damage if unit overheats due to insufficient air flow**
- **Line voltage compensation**
- **Automatic intermittent cutting - additional capability, permits continuous cutting of grates, expanded metal, heavy screen material, etc.**
- **Wheels and cylinder rack provides better portability and system utilization, standard on all manual packages and on mechanized packages with cylinder regulators**
- **Ideal for plasma gouging**
- **One-year warranty on torch**

The multi-gas packages include three R-6702 regulators that can be used with any non-corrosive gas.

The cylinder regulator packages include one N₂ Oxweld Elite Series Cylinder Regulator R-770-75-580, #0558010681, and two H-35 Oxweld Elite Series Cylinder Regulator R-770-75-350, #0558010679, and three 25 ft. (7.6 m) hoses.

The air regulator packages include an air regulator/filter panel.



Ordering Information

230/460/575V, 3ph, 60Hz. Includes: console, PT-26 torch with leather sheath, torch spare parts kit, 25 ft. (7.6 m) or 50 ft. (15.2 m) work cable, TR-21 truck with dual cylinder rack, regulators, gas hoses, and torch coolant.

ESP-150 Packages with PT-26 Torch

25 ft. (7.6 m), 70° Air	0558002909
50 ft. (15.2 m), 70° Air	0558002910
25 ft. (7.6 m), 90° Air	0558002911
50 ft. (15.2 m), 90° Air	0558002912
25 ft. (7.6 m), SL Air ¹	0558010130
50 ft. (15.2 m), SL Air ¹	0558010131
25 ft. (7.6 m), 70° Ar+H2 Mix	0558002915
50 ft. (15.2 m), 70° Ar+H2 Mix	0558002916
25 ft. (7.6 m), 90° Ar+H2 Mix	0558002917
50 ft. (15.2 m), 90° Ar+H2 Mix	0558002918
25 ft. (7.6 m), SL Multi-Gas ¹	0558010132
50 ft. (15.2 m), SL Multi-Gas ¹	0558010133

¹Does not include the cylinder rack/wheel kit.

ESP-150 Packages 380/400/415V, 3ph, 50Hz, "CE"

25 ft. (7.6 m), 70° Air	0558003472
50 ft. (15.2 m), 70° Air	0558003473
25 ft. (7.6 m), 90° Air	0558003474
50 ft. (15.2 m), 90° Air	0558003475
25 ft. (7.6 m), SL Air	0558010134
50 ft. (15.2 m), SL Air	0558010135
25 ft. (7.6 m), SL Multi-Gas ¹	0558010136
50 ft. (15.2 m), SL Multi-Gas ¹	0558010137

For use in regions that require "CE" such as Europe, Russia, and Australia.

¹Does not include the cylinder rack/wheel kit.

Instruction Manual, 230/460/575V	F-15-687
Instruction Manual, 400V "CE"	0558003744 and 0558004122
Product Data Page.....	PAC-21062

ESP-150



Ordering Information continued

ESP-150 Packages with PT-36R Torch

Includes: console, PT-36R torch with leather sheath, 25 ft. (7.6 m) or 50 ft. (15.2 m), start-up kit, torch repair & accessories kit, regulators, gas hoses, and torch coolant.

- 230/460/575V, 3ph, 60Hz, 25 ft. (7.6 m) Air¹ 0558010113
- 230/460/575V, 3ph, 60Hz, 50 ft. (15.2 m) Air¹ .. 0558010114
- 380/400/415V, 3ph, 50Hz, 25 ft. (7.6 m) Air¹ 0558010552
- 380/400/415V, 3ph, 50Hz, 50 ft. (15.2 m) Air¹ .. 0558010553

¹Does not include the cylinder rack/wheel kit.

Options & Accessories

- 150A spare parts kit 0558002864
- Remote hand switch, 25 ft. (7.6 m) 2075600
- Remote hand switch, 50 ft. (15.2 m) 0558004781
- Leather sheath, 25 ft. (7.6 m) 0558002921
- Leather sheath, 50 ft. (15.2 m)¹ 0558002922
- Plasma flow measuring kit 0558000739
- Plasma torch head protector 20806

¹Standard on manual torches.

Specifications

ESP-150 System	
Cuts, in. (mm)	2 (50.8)
Severs, in. (mm)	2-1/2 (63.5)
Output	150A @ 90% duty cycle 140A @ 100% duty cycle
Open circuit voltage	370 VDC
Input	220/230/380/415/460/575V, 3ph, 50/60Hz, 121/112/70/64/56/45A
Dimensions, LxWxH, in. (mm)	40x21.75x31.5 (1016x552x800)
Weight, lbs. (kg)	756 (308)

Plasma
Equipment



Plasma Gouging Metal Removal Rates

ESP-150	Metal Removal Rate, lbs/hr (kg/hr)	Groove Width/Depth, in. (mm)	IPM (m/min)	Comparable CAG Electrode, in. (mm)
Mild Steel	38 (17)	.375/.180 (9.5/4.6)	60 (1.5)	3/8 (9.5) Carbon
Stainless Steel	54 (24.5)	.437/.205 (11/5.2)	60 (1.5)	3/8 (9.5) Carbon
Aluminum	21 (9.5)	.375/.230 (9.5/5.8)	60 (1.5)	3/8 (9.5) Carbon

Deuce Pack 150



- With 300A of plasma cutting and gouging power, this heavy-duty system is the ideal choice for foundries, mining, logging equipment repair, and other industrial applications
- Handles even the heaviest materials with the capacity to cut up to 4 in. (101.6 mm) manually
- Eliminates carbon arc fumes with excellent plasma gouging capacity - removes up to 77 lbs. (35 kg) of metal an hour
- For exceptional versatility, separates into two 150A consoles for smaller scale applications
- Adjustable output down to 30A facilitates cutting of thinner metals
- Built-in water cooler simplifies maintenance, less hookup, no wiring issues, no extra hoses, and water flow is controlled with power supply
- Leather sheath wrapped torch protects torch leads from abrasion and molten metal
- Cuts with air, Nitrogen, Argon/Hydrogen mixtures or Nitrogen/Hydrogen mixtures
- Built-in CNC interface provides easy connection of automation applications
- Torch design provides perfect electrode centering; provides longer tip life by minimizing the possibility of double-arcing
- Torch spare parts kit supplied with each outfit; ample supply of spare parts at no additional cost to minimize downtime
- Thermal overload switches - prevents damage if unit overheats due to insufficient air flow
- Line voltage compensation
- Automatic intermittent cutting - additional capability, permits continuous cutting of grates, expanded metal, heavy screen material, etc.
- One-year warranty on torch



Plasma Equipment

Ordering Information

Includes: two ESP-150 consoles, torch, coolant circulator built into the console, spare parts kit, regulator, gas hoses, work cable, and water hose.

Deuce Pack Packages, 230/460/575V, 3ph, 60Hz

Deuce Pack 150, PT-26, 50 ft. (15.2 m) 0588000981
 Deuce Pack 150, PT-19XLS, 50 ft. (15.2 m) 0588001019
 Deuce Pack 150, PT-26, 50 ft. (15.2 m) in-line . 0588001166

Deuce Pack Packages, 400V, 3ph, 50Hz, "CE"

Deuce Pack 150, PT-26, 50 ft. (15.2 m) 0588001011
 Deuce Pack 150, PT-19XLS, 50 ft. (15.2 m) 0588001018
 Deuce Pack 150, PT-26, 50 ft. (15.2 m) in-line . 0588001064

For use in regions that require "CE" such as Europe, Russia, and Australia.

Options & Accessories

Plasma flow measuring kit 0558000739
 Plasmit torch head protector 20806
 Leather sheath, 10 ft. (3 m) length 20812
 TR-21 wheel kit 680794
 Torch coolant 0560950312

Deuce Pack 150



Specifications

Deuce Pack 150 System	
Cuts, in. (mm)	4 (101.6)
Gouging, lbs/hr (kg/hr)	56 (25.4) CS 77 (35) SS
Capacity	300A @ 90% duty cycle
Output	300A @ 90% duty cycle 280A @ 100% duty cycle
Open circuit voltage	370 VDC
Input	230/460/575V, 3ph, 60Hz, 224/112/90A
Weight, lbs. (kg)	1320 (600)
Current capacity (all service gases / pressures)	200A @ 100% duty cycle DCSP 300A @ 60% duty cycle DCSP
Max. rated current	300A DCSP
Approved service gases: Plasma Shield	Air, N ₂ , H-35, N ₂ /H ₂ Mixtures Air, N ₂ , CO ₂ , Ar
Min. gas supply flow requirements, cfh @ psig (L/min @ bar): Plasma Shield	240 @ 80 (112 @ 5.6) 200 @ 80 (94 @ 6.0)
Length of service leads, ft. (m)	25 (7.6) 50 (15.2)
Weight of service leads, ft.-lbs. (m-kg)	25 - 16 (7.6-7.3) 50 -28 (15.2-12.7)
Max. allowable inlet gas pressure, psig (bar)	100 (7)
Min. allowable inlet gas pressure, psig (bar)	40 (2.8)
Min. water supply flow requirements, gpm @ psig (L/min @ bar)	0.9 @ 95 (3.4 @ 6.6)
Max. water inlet pressure, psig (bar)	120 psig (8.3 bar)
Max. water supply temperature, °F (°C)	105 (40)

Plasma
Equipment

Plasma Gouging Metal Removal Rates

Deuce Pack 150	Metal Removal Rate, lbs/hr (kg/hr)	Groove Width/Depth, in. (mm)	IPM (m/min)	Comparable CAG Electrode, in. (mm)
Mild Steel	107 (48.5)	.562/.280 (14.3/7.1)	60 (1.5)	5/8 (15.9) Carbon
Stainless Steel	110 (49.8)	.625/.350 (15.9/8.9)	60 (1.5)	5/8 (15.9) Carbon
Aluminum	45 (20.4)	.680/.350 (17.3/8.9)	60 (1.5)	5/8 (15.9) Carbon

ESP-150 & Deuce Pack 150

Customized ESP-150 and Deuce Pack mechanized and manual plasma systems are available. Multiple power supplies, torch types and lengths, gas regulation options, and hose and cable lengths are offered, which allows the system to be customized to meet the precise needs of a particular application. The large number of options also allows these systems to be extremely versatile.

Contact your ESAB Sales representative or ESAB's Plasma Product Management team to have a custom system configured to your exact specifications.

Refer to the options and accessories shown below when ordering or calling for a quote. Choice of power supply and torch will effect the package options available.

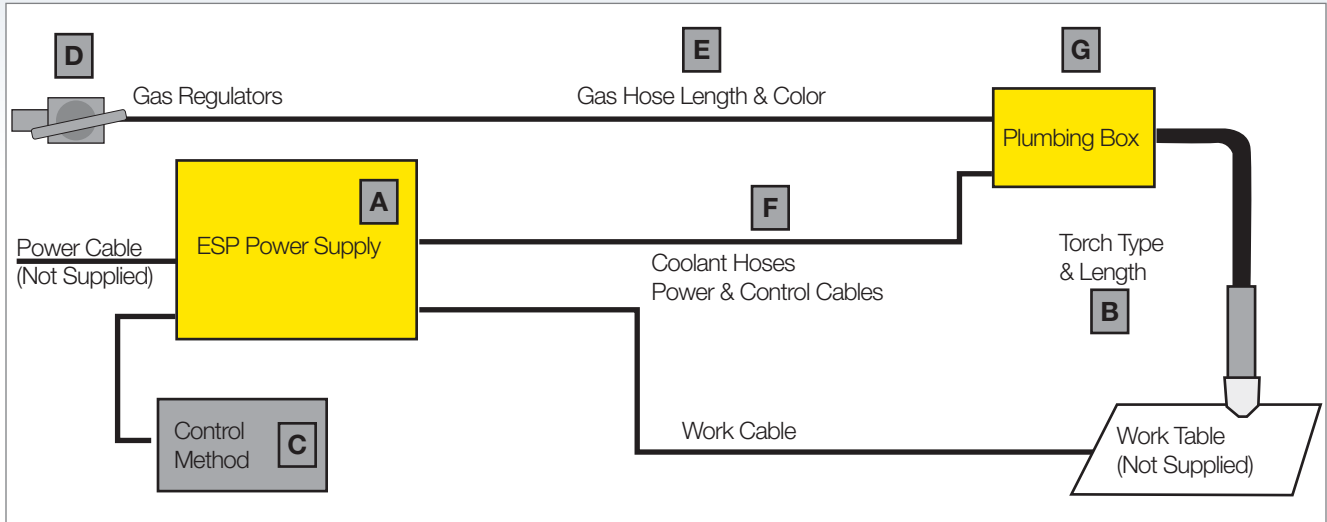

A ESP Console

ESP-150

230/460/575V	0558002677
220/380/415V CE	0558002713

B Torch Type & Torch Length

PT-26

70°, 25 ft. (7.6 m)	0558002208
70°, 50 ft. (15 m)	0558002209
90°, 25 ft. (7.6 m)	36558
90°, 50 ft. (15.2 m)	36559

PT-26SL

17 ft. (5.2 m)	0558005620
25 ft. (7.6 m)	0558005621
50 ft. (15.2 m)	0558005622

Start Up Kit, PT-26

150A	0558002864
200-300A	36821

PT-19XLS

4.5 ft. (1.4 m)	37086
6 ft. (1.8 m)	37087
12 ft. (3.7 m)	37088
15 ft. (4.6 m)	37089
17 ft. (5.2 m)	37090
20 ft. (6.1 m)	37091
25 ft. (7.6 m)	37092
50 ft. (15.2 m)	37093

Deuce Pack

230/460/575V	0588001333
220/380/415V CE	0588001336

Start Up Kit, PT-19XLS

150A	0558004765
PT-19XLS	37307
Repair & accessories kit	0558004778

PT-36R

4.5 ft. (1.4 m)	0558006811
6 ft. (1.8 m)	0558006812
12 ft. (3.7 m)	0558006813
15 ft. (4.6 m)	0558006815
17 ft. (5.2 m)	0558006816
25 ft. (7.6 m)	0558006817
Bevel torch, 14 ft. (4.3 m)	0558006814

Start Up Kit, PT-36

150-200A	0558005222
300A	0558007537
Repair & accessories kit	0558005225

C Control Methods

Hand Switches

25 ft. (7.6 m)	2075600
50 ft. (15.2 m)	0558004781

CNC Cables

30 ft. (9 m)	57002248
50 ft. (15.2 m)	57002249
75 ft. (23 m)	57002250
100 ft. (30.5 m)	57002251
160 ft. (48.7 m)	57002252

Torch Switch Extension Cables

25 ft. (7.6 m)	0558007530
50 ft. (15.2 m)	0558007531
75 ft. (23 m)	0558007532
100 ft. (30.5 m)	0558007533
125 ft. (38 m)	0558007534

D Gas Regulators

Air regulator assembly	0558003242
Multi-gas regulator assembly	0558004777
N ₂ Oxweld Elite Series cylinder regulator	0558010681
H-35 Oxweld Elite Series cylinder regulator	0558010679

E Gas Hose Length Optional Plasma Gas Hose Color

Black

25 ft. (7.6 m)	33122
50 ft. (15.2 m)	33123
75 ft. (23 m)	33124
100 ft. (30.5 m)	33125
125 ft. (38 m)	33126

Green

25 ft. (7.6 m)	33117
50 ft. (15.2 m)	33118
75 ft. (23 m)	33119
100 ft. (30.5 m)	33120
125 ft. (38 m)	33121

Blue

25 ft. (7.6 m)	0558002973
50 ft. (15.2 m)	0558002974
75 ft. (23 m)	0558002975
100 ft. (30.5 m)	0558002976
125 ft. (38 m)	0558002977

F Coolant Hoses Power & Control Cables

Coolant Hoses

25 ft. (7.6 m)	33132
50 ft. (15.2 m)	33133
75 ft. (23 m)	33134
100 ft. (30.5 m)	33135
125 ft. (38 m)	33136

Control Cables, Console to PB

25 ft. (7.6 m)	22264
50 ft. (15.2 m)	22265
75 ft. (23 m)	22266
100 ft. (30.5 m)	22267
125 ft. (38 m)	22268

Pilot Arc Cables

25 ft. (7.6 m)	33303
50 ft. (15.2 m)	33304
75 ft. (23 m)	33305
100 ft. (30.5 m)	33306
125 ft. (38 m)	33307

Power Cables

25 ft. (7.6 m)	22001
50 ft. (15.2 m)	22002
75 ft. (22.9 m)	22003
100 ft. (30.5 m)	22004
125 ft. (38.1 m)	22005

All cables must be the same length.

G

Plumbing box PCC-14	0558005840
---------------------------	------------

Coolant

25% PG torch coolant	0558004297
50% EG torch coolant	0560950312

Work Cables

25 ft. (7.6 m)	678723
50 ft. (15.2 m)	678724
Handheld speedloader	0558006164
Pilot arc adaptor	999278
Adaptor B/ACETF B/I-F	19X54
Adaptor B/A-W*M 1/4 NPTM old	10Z30



m³ Precision Plasma System



- ESAB's m³ Plasma system takes plasma productivity to new heights - now multiple plasma cutting and marking features are available in a single easy-to-use system
- Perform high speed plasma cutting, high precision cutting, plasma marking, thick-plate cutting, dry (multi-gas) cutting, and water injection cutting all with a single plasma system
- This remarkable system can quickly and accurately cut and mark a wide variety of materials - it can cut as thin as 20 ga. (2 mm), or as thick as 6 in. (150 mm), depending on which plasma power source is installed
- The m³ Plasma system features the most advanced gas control system in the industry, fully automated by ESAB's Vision CNC
- Great flexibility in selection and mix of shield gases allows an operator to produce the best cut quality on any material
- Simply select the material type and thickness, and the Vision CNC automatically sets the start, cut, and shield gas pressures and flow rates
- Process parameters for most plasma cutting and marking applications are pre-loaded in the Vision CNC, and custom parameter files can be easily created as needed
- Precision cutting in the ISO 9013 quality range 3
- Typically 2° or less cut edge angle (Precision Mode)
- Sharp top & bottom edge with virtually no dross
- Cutting over dry table or under water
- Straight or bevel cutting up to +/- 45°
- Longer consumable life and lower consumable cost
- Fewer parts to purchase and stock
- Highly efficient, high power factor designs
- Modular system grows with your needs



Plasma Equipment

Specifications

	m ³ 200 Amp System	m ³ 360 Amp System	m ³ 450 Amp System	m ³ 600 Amp System
Output range (cutting)	30 - 200A	30 - 360A	30 - 450A	30 - 600A
Output range (marking)	10 - 36A	10 - 36A	10 - 100A	10 - 100A
Open circuit voltage	360 VDC	360 VDC	430 VDC	430 VDC
Dimensions, LxWxH, in. (mm)	47x23x41(1194x584x1041)	47x23x41(1194x584x1041)	45x37x41(1143x940x1041)	45x37x41(1143x940x1041)

Product Data Page, EPP 201 MCUT-3036
 Product Data Page, EPP-360 MCUT-3037
 Product Data Page, EPP-450 MCUT-3038
 Product Data Page, EPP-601 MCUT-3039
 Product Data Page, m3 Precision Plasma PAC-21209
 m3 Plasma Brochure MCUT-3014

m³ Precision Plasma System



Materials & Thicknesses

Mild Steel

Power Supply	Cutting Current	Material Thickness ¹ in. (mm)
m ³ Plasma 201	30-200 Amps	.040-1.25 (1.0-31.75)
m ³ Plasma 360	30-360 Amps	.040-1.5 (1.0-38)
m ³ Plasma 450	35-450 Amps	.040-2.0 (1.0-51)
m ³ Plasma 601	35-450 Amps	.040-2.0 (1.0-51)
m ³ Plasma 720	35-450 Amps	.040-2.0 (1.0-51)

¹Recommended range for production cutting and piercing mild steel with O₂.

Mild Steel

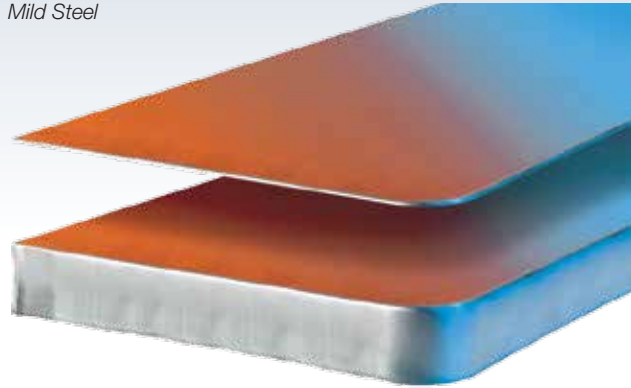

Stainless Steel

Power Supply	Cutting Current	Material Thickness ¹ in. (mm)
m ³ Plasma 201	30-200 Amps	.040-1.25 (1.0-31.75)
m ³ Plasma 360	30-360 Amps	.040-1.5 (1.0-38)
m ³ Plasma 450	35-450 Amps	.040-2.0 (1.0-51)
m ³ Plasma 601	35-450 Amps	.040-6.0 (1.0-152.4)
m ³ Plasma 720	35-450 Amps	.040-6.0 (1.0-152.4)

¹Recommended range for production cutting of Stainless Steel. Piercing and cutting up to 3 in. thick with H-35 gas (65% argon/35 % hydrogen) at 600 and 720A. Cutting from 3 - 6 in. stainless is edge starting ONLY.

Stainless Steel



Aluminum

Power Supply	Cutting Current	Material Thickness ¹ in. (mm)
m ³ Plasma 201	30-200 Amps	.040-1.25 (1.0-31.75)
m ³ Plasma 360	30-360 Amps	.040-1.5 (1.0-38)
m ³ Plasma 450	35-450 Amps	.040-2.0 (1.0-51)
m ³ Plasma 601	35-450 Amps	.040-6.0 (1.0-152.4)
m ³ Plasma 720	35-450 Amps	.040-6.0 (1.0-152.4)

¹Recommended range for production cutting of Aluminum. Piercing and cutting up to 3 in. thick with H-35 gas (65% argon/35 % hydrogen) at 600 and 720A. Cutting from 3 - 6 in. aluminum is edge starting ONLY.

Aluminum Steel



Plasma
Equipment



Product Data Page, EPP 201	MCUT-3036
Product Data Page, EPP-360	MCUT-3037
Product Data Page, EPP-450	MCUT-3038
Product Data Page, EPP-601	MCUT-3039
Product Data Page, m3 Precision Plasma	PAC-21209
m3 Plasma Brochure	MCUT-3014

PT-17A/PT-17AM Manual Torch



- Excellent cutting capability - cuts up to 1-1/4 in. (31.75 mm); severs up to 1-1/2 in. (38.1 mm); pierces up to 1/2 in. (12.7 mm)
- Produces clean, high quality cuts
- Patented safety circuit for enhanced operator safety
- Operate with shop or cylinder air
- Compact, lightweight design for easy handling
- Long life electrodes lower operating costs
- Pilot arc starting - even starts on paint
- Gouging nozzles available
- Intermittent cutting capability for grate or expanded metal applications
- Standard and drag shield guards available for operator convenience



Plasma Equipment



Consoles

The PT-17A / PT-17AM can be used with the following older ESAB consoles:

- PCM-875 (w/adaptor P/N 19500)
- PCM-1125 (w/adaptor P/N 19500)
- PCM-100
- PCM-150

Ordering Information

PT-17A, 75°

25 ft. (7.6 m) lead 19999
 50 ft. (15.2 m) lead 20000

PT-17AM, Mechanical

25 ft. (7.6 m) lead 20001
 50 ft. (15.2 m) lead 20002

These versatile, easy to use 100 Amp torches provide superior performance for a full range of manual and mechanized cutting applications.

Options & Accessories

Spare Parts Kits

50A 20062
 70A 20063
 100A 20064
 Plasma flow measuring kit 0558000739

Torch Guide Kits

Deluxe: 1-3/4 in. (44.5 mm) 42 in. (106 cm) radius . 0558003258
 Basic: 1-3/4 in. (44.5 mm) 28 in. (71 cm) radius . 0558002675

Plasmit torch head protector, 75° 20803
 Leather sheath, 10 ft. (3 m)..... 20812
 Heavy-duty heat shield 20747
 Heat shield guard..... 19990
 Drag heat shield guard 19989

Specifications

PT-17A/PT-17AM	
Cuts, in. (mm)	1-1/4 (31.75)
Severs, in. (mm)	1-1/2 (38.1)
Pierces, in. (mm)	1/2 (12.7)
Current capacity	100A @ 100% duty cycle
Air supply, cfh @ psig (L/min)	290 @ 75 (140)
Length of service leads, ft. (m)	25 (7.6) 50 (15.2)
Dimensions, in. (mm)	
PT-17A	10 (254) length, 2.87 (730) torch head
PT-17AM	17.25 (438) length

PT-17A/PT-17AM Manual Torch

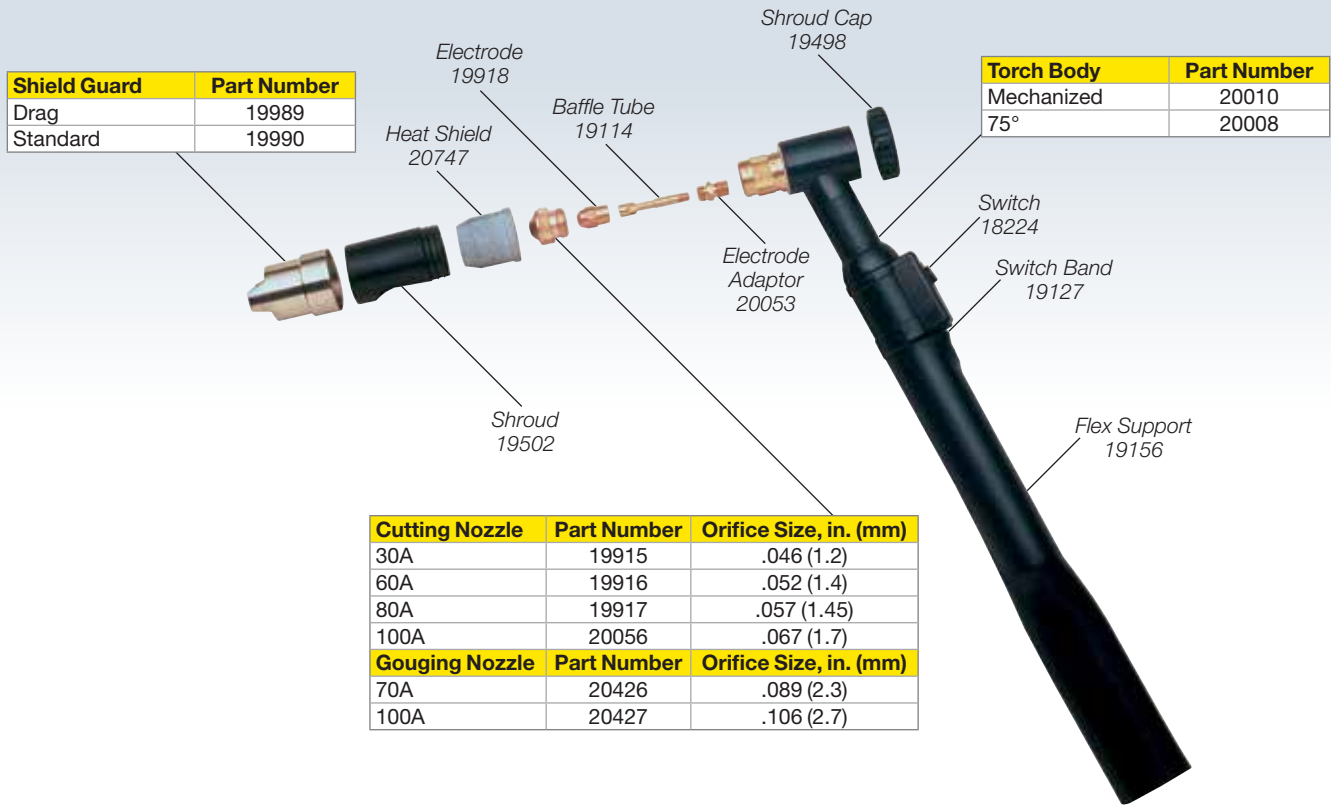

Plasma
Equipment



Spare Parts Kit

Description	Part Number	50A - 20062	70A - 20063	100A - 20064
Heat shield	20747	2	2	2
Shield guard, drag	19989	2	2	2
Shield guard, standard	19990	1	1	1
Nozzles (30A)	19915	5	5	-
Nozzles (60A)	19916	-	5	5
Nozzles (80A)	19917	-	5	5
Nozzles (100A)	20056	-	-	5
Nozzles, gouging (70A)	20426	-	1	-
Nozzles, gouging (100A)	20427	-	-	1
Electrode	19918	5	5	5
Electrode adaptor	20053	1	1	1
Baffle tube	19114	1	1	1
Shroud cap	19498	1	1	1
Shroud	19502	1	1	1
Wrench	19129	1	1	1
Pilot arc adaptor	19497	1	1	1

PT-121/PT-121M Manual Torch



- Excellent performance - cuts up to 2 in. (50.8 mm); pierces up to 1/2 in. (12.7 mm)
- Automatic pilot arc starting
- Uses Nitrogen or H-35 for plasma gas; uses air, Nitrogen, Oxygen, Carbon Dioxide or Argon for cooling gas
- Choice of 75°, 90° or mechanical torches
- Extended front end available
- Gouging nozzles and heat shield available



Plasma Equipment

Console

The PT-121 can be used with the following older ESAB console:

- PCM-150

Ordering Information

PT-121, 75°	
25 ft. (7.6 m) lead	999242
50 ft. (15.2 m) lead	999243
PT-121, 90°	
25 ft. (7.6 m) lead	999246
50 ft. (15.2 m) lead	999247
PT-121M	
25 ft. (7.6 m) lead.....	999244
50 ft. (15.2 m) lead	999245

This highly versatile torch operates with a variety of gases and offers superior cutting and gouging capability.

Options & Accessories

150A spare parts kit	19539
Plasma flow measuring kit	0558000739
Plasmit Torch Protector	
75°	20742
90°	20801
Mechanical	20802
Leather sheath, 10 ft. (3 m).....	
	20812
Gouging Heat Shield	
Heavy-duty	20087
Two-piece non-ceramic	20378
1/16 in. (1.6 mm) cutting nozzle'	20859
<i>'Use with centering adjustment tool #948178.</i>	

Specifications

PT-121	
Cuts, in. (mm)	2 (50.8)
Current capacity	150A @ 100% duty cycle
Gas requirements: Plasma cutting Plasma gouging	N2 @ 25 psig (25 cfh), H-35 @ 65 psig (75 cfh) H-35 @ 20 psig (130 cfh)
Cooling gas requirements': Plasma cutting Plasma gouging	N2, Air @ 50 psig (345 cfh), CO ₂ @ 50 psig (270 cfh) Ar, N2, Air @ 50 psig (260 cfh) ¹
Length of service leads, ft. (m)	25 (7.6) 50 (15.2)

¹Argon preferred.

PT-121/PT-121M Manual Torch



Cutting Nozzle	Part Number	Orifice Size, in. (mm)
30A	17184	.032 (0.8)
55A	17119	.047 (1.2)
110A	999263	.055 (1.4)
150A	999264	.063 (1.6)
Gouging Nozzle		Part Number
70A	20386	
100A	20387	
150A	19160	

Torch Body	Part Number
90°	999283
75°	999248
Mechanized	999270

Shield	Part Number
Standard	999261
50A, Drag	999620
120A, Drag	18419

Shield	Part Number
Long	18363
Gouging	31411

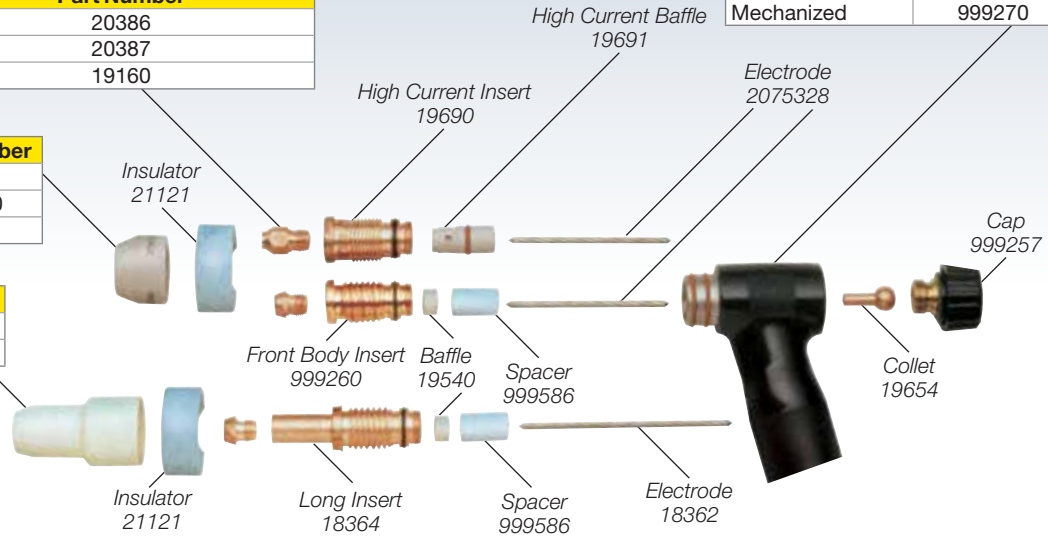

Spare Parts Kit

Description	Part Number	19539
Electrode, standard	2075328	5
Electrode, long	18362	2
Nozzle 150A	999264	5
Nozzle 110A	999263	5
Nozzle 55A	17119	5
Nozzle Gouging 150A	19160	2
Collet (copper), heavy-duty	19654	2
Heat shield	999261	2
Heat shield, long	18363	2
Heat shield, gouging	31411	2
Heat shield, drag	18419	2
Front body insert	999260	1
Front body insert, long	18364	1
High current insert	19690	2
High current baffle	19691	2
Baffle	19540	2
Spacer	999586	1
Torch cap	999257	1
Lubricant .25 oz	0558000443	1
O-Ring	994092	5
O-Ring	96W97	2
O-Ring	85W50	2
Wrench	999568	1
Center-adjust tool	999266	2
Tool box	950272	1

Plasma
Equipment



PT-25 Manual Torch



- Excellent cutting capability - cuts up to 1-1/2 in. (38.1 mm) using air or Nitrogen at 100A; cuts up to 2 in. (50.8 mm) using Nitrogen or Argon-Hydrogen at 150A
- Produce clean, high quality cuts
- Patent pending safety circuit for enhanced operator safety
- Operate with shop or cylinder air at 100A; Nitrogen or Argon-Hydrogen at 150A
- Compact, lightweight design for ease of handling
- Long-life electrodes lower operating costs
- Pilot arc starting - even starts on paint
- Gouging nozzle available
- Intermittent cutting capability for grate or expanded metal applications
- Gouging guard and stand-off guide available for operator convenience



This versatile, easy-to-use 150 Amp torch provides superior performance for a full range of manual cutting applications.

Consoles

The PT-25 can be used with the following older ESAB consoles:

- ESP-100i standard
- PCM-150 with retrofit kit P/N 21932
- PCM-100 with retrofit kit P/N 21932

Ordering Information

PT-25, 90°	
25 ft. (7.6 m) lead.....	21648
50 ft. (15.2 m) lead.....	21649
25 ft. (7.6 m) "CE" ¹	21650
50 ft. (15.2 m) "CE" ¹	21651

¹For use in regions that require "CE" such as Europe, Russia, and Australia.

Options & Accessories

Torch Guide Kits

Deluxe: 1-3/4 in. (44.5 mm) 42 in. (106 cm) radius . 0558003258
 Basic: 1-3/4 in. (44.5 mm) 28 in. (71 cm) radius . 0558002675

Plasmit torch head protector	20801
Leather sheath, 10 ft. (3 m) length	20812
Plasma flow measuring kit	0558000739
Retrofit kit for PCM-100/150 ¹	21932
"CE" swirl baffle ²	0558001457

¹Enables use of PT-25 with PCM-100/150.

²For use in regions that require "CE" such as Europe, Russia, and Australia.

Specifications

PT-25	
Current capacity @ 100% duty cycle	100A DCSP (Air Plasma) 150A DCSP (N ₂ , H-35, N ₂ /H ₂ Plasma)
Approved service gases: Plasma Cooling	Air, N ₂ , H-35, N ₂ /H ₂ mixtures Air, N ₂ , CO ₂
Min. gas flow requirements: Plasma Cooling	200 cfm @ 70 psig 360 cfm @ 70 psig
Length of service leads, ft. (m)	25 (7.6) 50 (15.2)
Weight of service leads, lbs. (kg): 25 ft. (7.6 m) 50 ft. (15.2 m)	14 (6.4) 25 (11.4)



PT-25 Manual Torch



Plasma
Equipment

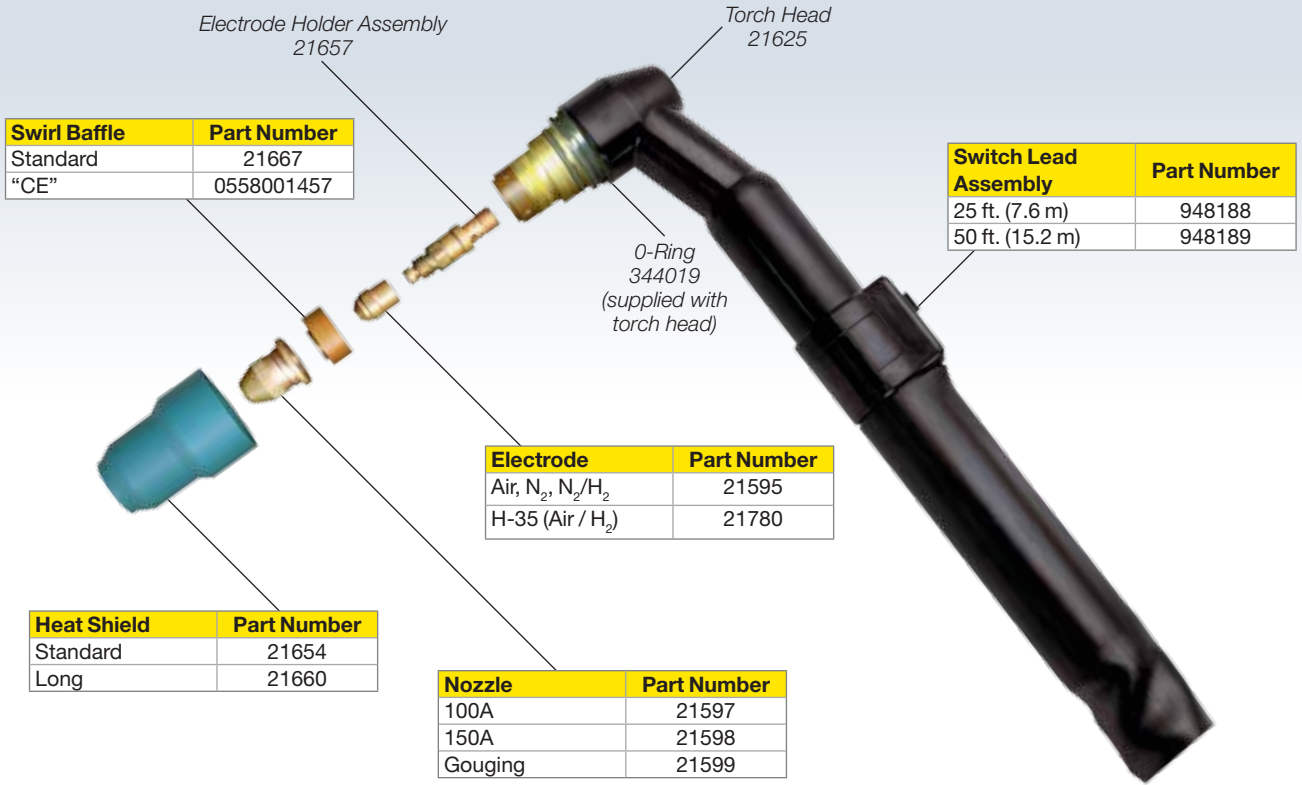

Spare Parts Kit

Description	Part Number	100A - 21946	150A - 21947
Heat shield	21654	2	2
Nozzles (100A)	21597	5	-
Nozzles (150A)	21598	-	5
Nozzles, gouging	21599	2	2
Gouging guard	21656	1	1
Swirl baffle	21667	2	2
Electrodes (Air, N ₂ , N ₂ /H ₂)	21595	5	-
Electrodes [(H-35 (Air / H ₂))]	21780	-	5
Stand off guide	21943	1	1

PT-26 Manual/Mechanized Torch



- Excellent cutting capability - cuts up to 3-1/2 in. (88.9 mm) and severs 4 in. (101.6 mm) using air, Nitrogen or Argon-Hydrogen at 300A
- Produces clean, high quality cuts
- Patent pending safety circuit for enhanced operator safety
- Operates with shop or cylinder air, Nitrogen or Argon-Hydrogen at 300A
- Compact, lightweight design for easy handling
- Long life electrodes lower operating costs
- Pilot arc starting - even starts on paint
- Gouging nozzle available
- Intermittent cutting capacity for grate or expanded metal applications
- Gouging guard and stand-off guide available for operator convenience

Consoles

The PT-26 can be used with the following ESAB consoles:

- ESP-150
- ESP-200
- Deuce Pack 150

Note: In-line torches have 2 in. (50.8 mm) barrel diameter and come without rack or torch holder. SL-Slim Line torches have 1-3/8 in. (35 mm) barrel diameter and come with rack and torch holder.



This versatile, easy-to-use 300 Amp torch provides superior performance for a full range of manual and mechanized cutting applications.

Ordering Information

PT-26, 90°	
25 ft. (7.6 m) lead.....	36558
50 ft. (15.2 m) lead.....	36559
PT-26, 70°	
25 ft. (7.6 m) lead.....	0558002208
50 ft. (15.2 m) lead.....	0558002209
PT-26, In-line	
25 ft. (7.6 m).	0558002320
50 ft. (15.2 m).	0558002321
PT-26, SL	
25 ft. (7.6 m).	0558005621
50 ft. (15.2 m).	0558005622

Specifications

PT-26	
Current capacity (all service gases and pressures): 100% duty cycle 60% duty cycle Maximum rated current	200A DCSP 300A DCSP 300A DCSP
Approved service gases: Plasma Shield	Air, N ₂ , H-35, N ₂ /H ₂ mixtures Air, N ₂ , CO ₂ , Ar
Min. gas flow requirements, cfm @ psig (L/min @ bar): Plasma Shield	240 @ 80 (112 @ 5.6) 200 @ 85 (94 @ 6.0)
Max. allowable inlet gas pressure, psig (bar)	100 (6.9)
Start gas pressure, psig (bar)	30 (2.8)
Min. water supply flow requirements, gpm @ psig (L/min @ bar)	0.9 @ 95 (3.4 @ 6.6)
Max. water inlet pressure, psig (bar)	120 (8.3)
Max. water temperature, °F (°C)	105 (40)
Length of service leads, ft. (m)	25 (7.6) 50 (15.2)
Weight of service leads, lbs. (kg): 25 ft. (7.6 m) 50 ft. (15.2 m)	14 (6.4) 28 (11.4)

PT-26 Manual/Mechanized Torch

Electrode	Part Number
Air, N ₂ , N ₂ /H ₂	36565
H-35 (Air / H ₂)	36566

Heat Shield	Part Number
Standard	34592
Close Proximity ¹	37146
Mechanized	0558003582

¹For use when cutting or gouging in close proximity of workpiece. Standard on In-line version.

Stand-Off Guide
36648

Baffle Tube
34585

O-Ring
2029450

O-Ring
2110706

Electrode Holder 34583
Includes O-Rings 85W49
(Upper) 948317 (Lower)

Insulator 34593
Includes O-Ring 84W87
Swirl Baffle In-line 0558003583

Torch Head	Part Number
90°	34599
70°	0558002204
In-line	0558002110

Includes O-rings 2110706 (1) and 2029450 (3).

Switch
18224

Switch Band
36647
(Manual torch only)

Cutting Nozzle	Part Number	Orifice Size, in. (mm)
50A	36567	.052 (1.3)
150A	36568	.078 (2.0)
200A	36569	.089 (2.3)
300A	36570	.104 (2.6)
Gouging Nozzle	Part Number	Orifice Size, in. (mm)
200A	36571	.125 (3.2)
300A	36572	.144 (3.7)

Includes O-rings 2110578 (upper) and 994092 (lower).

Options & Accessories

- Plasma torch head protector for gouging..... 20806
- Leather sheath, 25 ft. (7.6 m)¹ 0558002921
- Leather sheath, 50 ft. (15.2 m), slip-on ¹ 0558002922

Spare Parts Kits

- 300A Deuce Pack and ESP-200¹ 36821
- 150A ESP-150 0558002864

- Torch holder, 2 in. (51 mm) 0558002985
- Torch rigging kit 0558003186

¹Standard on manual torch.

Spare Parts Kit

Description	Part Number	36821	0558002864
		300A	150A
Electrode Air/N ₂	36565	3	3
Electrode H-35	36566	3	3
Nozzle 50A	36567	3	3
Nozzle 150A	36568	3	6
Nozzle 200A	36569	3	-
Nozzle 300A	36570	3	-
Nozzle, gouging 200A	36571	1	3
Nozzle, gouging 300A	36572	1	-
Wrench	19129	1	1
Heat shield	34592	1	1
Shield, close proximity	37146	1	1
Stand off guide	36648	1	1
Lubricant .25 oz	0558000443	1	1
O-Ring 1.176 ID .070 Nitrile	2029450	5	5
O-Ring 1.051 ID .07	2110706	5	5
O-Ring 0.612 ID	84W87	5	5
O-Ring 0.301ID	85W49	1	1
MT400 liner O-ring	2064068	1	1
Insulator	34593	1	1



PT-27 Manual Torch



- Most compact 80A torch on the market
- Excellent cutting capacity - cuts up to 1 in. (25.4 mm); severs up to 1-1/4 in. (31.75 mm)
- Uses shop air, cylinder air or Nitrogen for superior versatility
- Pilot arc starting - even starts through paint
- Choice of 25 ft. (7.6 m) or 50 ft. (15.2 m) lead length
- Perfect electrode centering
- Intermittent cutting capability for grate or expanded metal applications
- Use with three cutting nozzle sizes for exceptional versatility
- Improved spring-loaded seat eliminates head burn-out



Designed for superior cutting performance and ease of handling, the PT-27 produces clean, exceptionally high quality cuts.

Consoles

The PT-27 can be used with the following older ESAB consoles:

- PCM-80i
- PCM-750i
- PCM-875i
- PCM-1000i
- PCM-1125i

Ordering Information

PT-27, 75° Torch Assembly

25 ft. (7.6 m) lead with ring terminal	21661
50 ft. (15.2 m) lead with ring terminal	21662
25 ft. (7.6 m) "CE"	35548

For use in regions that require "CE" such as Europe, Russia, and Australia.

Cable Leads

25 ft. (7.6 m)	0558005677
50 ft. (15.2 m)	0558006547

Note: All torch assemblies and replacement heads are supplied with the seat installed.

For units manufactured prior to 4/31/1995 (that have 2 twist lock plugs for torch hook-up) order #21620 or #21621.

PT-27, 75°

25 ft. (7.6 m) lead with plug	21620
50 ft. (15.2 m) lead with plug	21621

Improved Seat Design

PT-27 spring-loaded seat dramatically improves the torch head life by making the PT-27 resistant to damage due to improperly tightened consumables. This seat will not correct a torch head that is already burnt out, but it will prevent torch head burnout on functioning torches.

If your PT-27 torch still has the old style valve pin, you will need to retrofit the torch to the improved seat design.

Options & Accessories

Spare Parts Kits

50-70A	21623
80A	21624
Plasma flow measuring kit	0558000739

Torch Guide Kits

Deluxe: 1-3/4 in. (44.5 mm) 42 in. (106 cm) radius ..	0558003258
Basic: 1-3/4 in. (44.5 mm) 28 in. (71 cm) radius ..	0558002675

Seat

Seat & installation instructions	0558003032
Installation tool	0558003027

Stand-off guide	21420
Gouging nozzle	35442
Gouging shield	35443

PT-27 Manual Torch

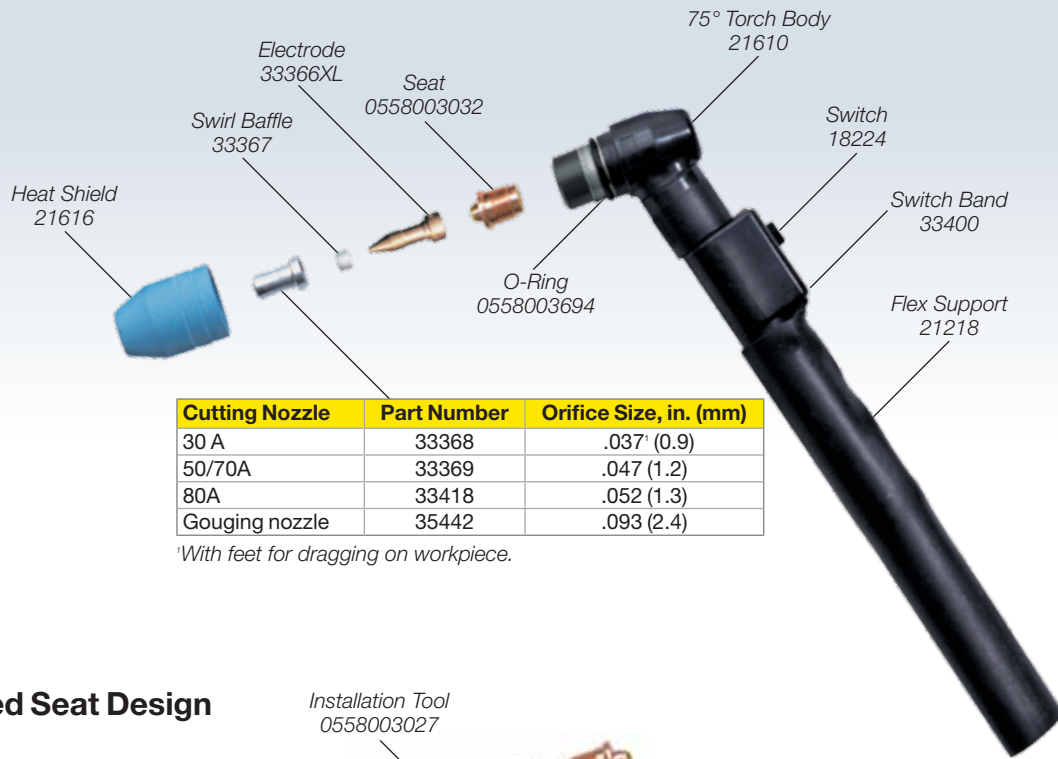

Cutting Nozzle	Part Number	Orifice Size, in. (mm)
30 A	33368	.037* (0.9)
50/70A	33369	.047 (1.2)
80A	33418	.052 (1.3)
Gouging nozzle	35442	.093 (2.4)

*With feet for dragging on workpiece.

Improved Seat Design



Spare Parts Kit

Description	Part Number	50/70A XT - 21623	80A XT - 21624
Heat shield	21616	2	2
Nozzles (50/70A)	33369	4	-
Nozzles (80A)	33418	-	4
Swirl baffle	33367	1	1
Electrode	33366XL	3	3
Fuse 15A, 600 VDC	952137	1	1
Stand off guide	21420	1	1
Lubricant .25 oz.	0558000443	1	1

Specifications

PT-27	
Cuts, in. (mm)	1 (25.4)
Severs, in. (mm)	up to 1-1/4 (31.75)
Current capacity	80A @ 100% duty cycle
Air supply, cfh @ psig (L/min)	320 @ 65 - 75 (150)
Length of service leads, ft. (m)	25 (7.6) 50 (15.2)
Dimensions, in. (mm)	7.3 (185) length, 3.06 (78) torch head



PT-31XL/PT-31XLPC Manual Torch



- Excellent cutting capability - manually cuts up to 3/4 in. (19 mm); severs up to 1 in. (25.4 mm)
- New, durable torch cable prevents snagging on fixtures and materials
- Equipped with patented safety interlock feature
- Uses shop air, cylinder air or Nitrogen for superior versatility
- High frequency starting - even starts through paint
- Uses patented "XT" consumables



Designed for superior operator comfort, ESAB's PT-31XL and PT-31XLPC are the most compact 50 Amp torches on the market.

Consoles

The PT-31XL and PT-31XLPC can be used with the following older ESAB consoles:

- Handy Plasma 250
- Handy Plasma 380
- Handy Plasma 550
- PowerCut 650

Ordering Information

PT-31XL	
75° head, 12.5 ft. (3.8 m) lead.....	0558005300
75° head, 15 ft. (4.6 m) lead	0558004482
75° head, 25 ft. (7.6 m) lead.....	0558004498
PT-31XLPC	
75° head, 25 ft. (7.6 m) lead	0558003183
75° head, 50 ft. (15.2 m) lead	0558005334

Options & Accessories

Spare Parts Kits	
30/40A (HP-250)	0558005281
30/40A (HP-380, HP-550, PC-650).....	0558003301
30/40A (PT-31XL).....	21980
Plasma flow measuring kit	0558000739
Torch Guide Kits	
Deluxe: 1-3/4 in. (44.5 mm) 42 in. (106 cm) radius .	0558003258
Basic: 1-3/4 in. (44.5 mm) 28 in. (71 cm) radius .	0558002675
<i>XT nozzles have extended shape.</i>	

Specifications

PT-31XL/PT31XLPC	
Cuts, in. (mm)	3/4 (19)
Severs, in. (mm)	1 (25.4) max
Current capacity	50A @ 100% duty cycle
Air supply, cfh @ psig (L/min)	275 @ 75 (130)
Length of service leads, ft. (m)	25 (7.6) 50 (15.2)
Dimensions, in. (mm)	5.25 (133) length, 2.25 (57) torch head

Instruction Manual, PT-31XL.....	F-14-246
Instruction Manual, PT-31XLPC.....	F-15-724
Product DataPage.....	PAC-21090

PT-31XL/PT-31XLPC Manual Torch

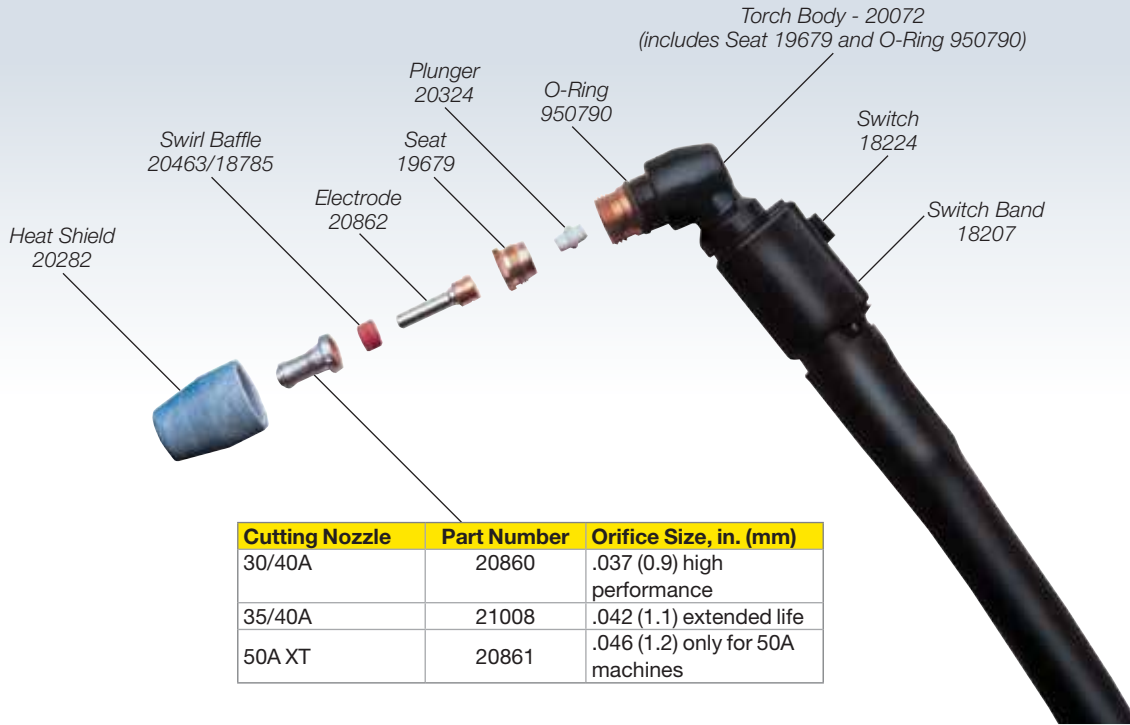

Spare Parts Kit

Description	Part Number	35/40A - 21980	0558005281	0558003301
Heat shield	20282	1	1	1
Nozzles (15/20A)	19667	-	3	-
Nozzles (30/40A)	20860	-	-	3
Nozzles (35/40A) extended life	21008	3	-	-
Swirl baffle	20463	1	-	1
Swirl baffle	18785	-	1	-
Electrode	20862	2	-	2
Electrode	18205	-	2	-
Lubricant .25 oz	0558000443	1	1	1

PT-32EH Manual Torch



- Most compact 90A torch on the market
- Durable torch cable prevents snagging on fixtures and materials
- Excellent cutting capacity - cuts up to 1-1/2 in. (38 mm)
- Uses shop air, cylinder air or Nitrogen for superior versatility
- Pilot arc starting - even starts through paint
- Choice of 25 ft. (7.6 m) or 50 ft. (15.2 m) lead length
- Excellent consumable life
- Parts in place design
- Patented torch and safety circuit
- Exclusive 40A drag nozzle



Plasma Equipment



Consoles

The PT-32EH can be used with the following older ESAB consoles:

- PowerCut 875
- PowerCut 1125
- PowerCut 1250
- PowerCut 1500

Designed for superior cutting performance and ease of handling, the PT-32EH patented torch produces clean, exceptionally high quality cuts. The new ergonomic handle offers dual-switch capability, extra comfort and a non-slip grip.

Ordering Information

PT-32EH 90° Torch Assemblies

25 ft. (7.6 m) lead	0558003548
50 ft. (15.2 m) lead	0558003549

PT-32EH Cable Assemblies

25 ft. (7.6 m)	0558002841
50 ft. (15.2 m)	0558002842

Torches and torch body assemblies are supplied without electrode, nozzle, heat shield, and valve pin.

Options & Accessories

Spare Parts Kits

50-70A (PC-875/1125)	0558002822
70A (PC-1250)	0558003508
90A (PC-1500)	0558003062
Plasma flow measuring kit	0558000739

Torch Guide Kits

Deluxe: 1 3/4 in. (44.5 mm) 42 in. (106 cm) radius .	0558003258
Basic: 1 3/4 in. (44.5 mm) 28 in. (71 cm) radius..	0558002675

Stand-off guide	0558002393
40A drag nozzle	0558002908
Gouging nozzle	0558003089
Heat shield gouging	0558003090
Heavy-duty drag heat shield	0558004206

Specifications

PT-32EH	
Cuts, in. (mm)	1-1/2 (38)
Current capacity	90A @ 100% duty cycle
Air supply, cfm @ psig (L/min @ bar)	350 @ 75-80 (165 @ 5.2 - 5.5)
Length of service leads, ft. (m)	25 (7.6) 50 (15.2)
Dimensions, in. (mm)	8.2 (208) length, 3 (76) torch head

Instruction Manual, PT-32	F-15-440
Instruction Manual, PT-32EH	F-15-747
Product Data Page	PAC-21091

PT-32EH Manual Torch

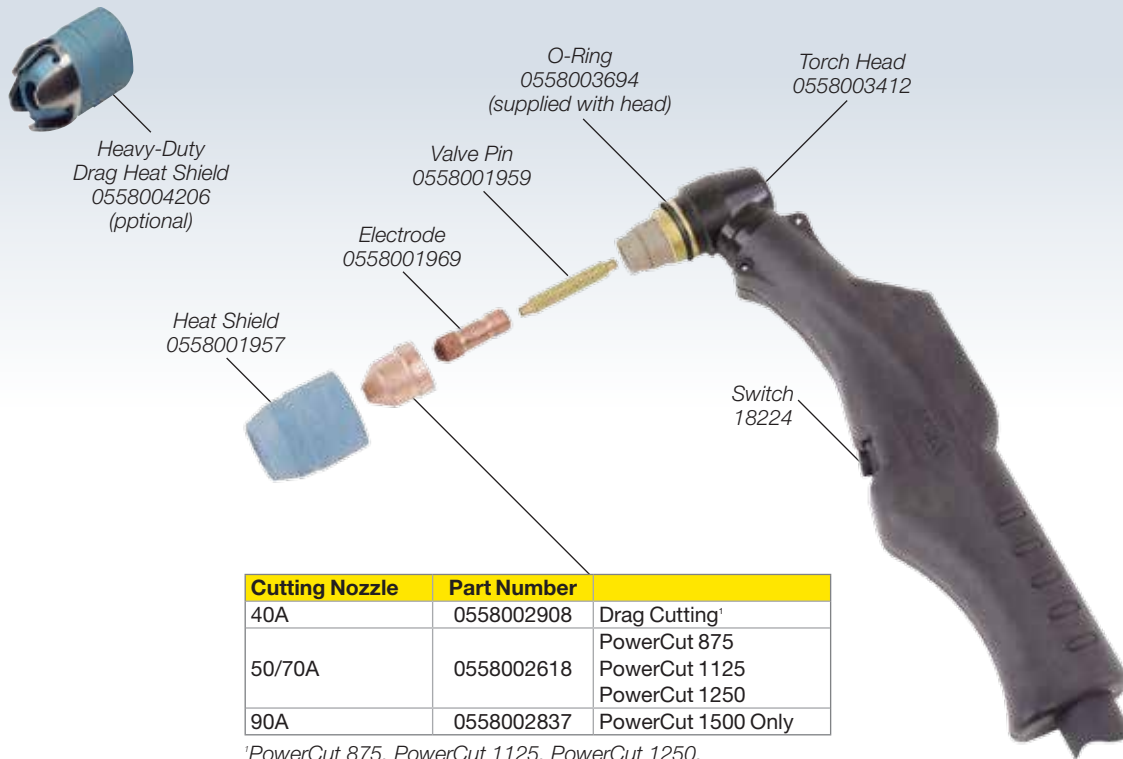

Cutting Nozzle	Part Number	
40A	0558002908	Drag Cutting ¹
50/70A	0558002618	PowerCut 875 PowerCut 1125 PowerCut 1250
90A	0558002837	PowerCut 1500 Only

¹PowerCut 875, PowerCut 1125, PowerCut 1250, and PowerCut 1500.

Plasma
Equipment



Spare Parts Kit

Description	Part Number	50/70A - 0558002822	70A - 0558003508	90A - 0558003062
Heat shield	0558001957	2	2	2
Nozzles (50/70A)	0558002618	4	4	-
Nozzles (90A)	0558002837	-	-	4
Nozzles, drag (40A)	0558002908	1	1	1
Electrode	0558001969	3	3	3
Valve pin	0558001959	1	1	1
Fuse 2A, 600 VDC	0558001379	-	1	1
Stand-off guide	0558002393	1	1	1
Wrench	19129	1	1	1
Lubricant .25 oz	0558000443	1	1	1

PT-38 Manual Torch



- Ergonomic handle for operator comfort
- Big face switch maximizes convenience when wearing welder's gloves
- New blowback technology
- Easily repairable in the field
- Minimum part configurations
- Molded strain relief for secure torch leads



Consoles

The PT-38 can be used with the following ESAB consoles:

- PowerCut 900
- PowerCut 1300
- PowerCut 1600

Designed for superior cutting performance and ease of handling, the PT-38 torch produces clean, high quality cuts.

Ordering Information

PT-38 Torch Assemblies

25 ft. (7.6 m) lead.....	0558006786
50 ft. (15.2 m) lead.....	0558006787

PT-38 Cable Assemblies

25 ft. (7.6 m)	0558006800
50 ft. (15.2 m)	0558006801

Torches and torch body assemblies are supplied without electrode, nozzle, heat shield, and valve pin.

Options & Accessories

Spare Parts Kits

60A (PC 900).....	0558008418
70A (PC 1300).....	0558007641
90A (PC 1600)	0558007639
Plasma flow measuring kit	0558000739

Torch Guide Kits

Deluxe: 1-3/4 in. (44.5 mm) 42 in. (106 cm) radius .	0558003258
Basic: 1-3/4 in. (44.5 mm) 28 in. (71 cm) radius .	0558002675

Stand-off guide.....	0558006614
40A drag nozzle	0558007682
Gouging heat shield 60A.....	0558008591
Gouging heat shield 70-90A	0558008186
Gouging nozzle 60A.....	0558008588
Gouging nozzle 70-90A	0558007681

Specifications

PT-38	
Cuts, in. (mm)	1-1/2 (38)
Current capacity	90A @ 100% duty cycle
Air supply, cfm @ psig (L/min @ bar)	400 @ 80 (165 @ 4.8 - 5.5)
Length of service leads, ft. (m)	25 (7.6) 50 (15.2)
Dimensions, in. (mm)	8.2 (208) length, 3 (76) torch head



PT-38 Manual Torch



PT-38 Cut Speeds

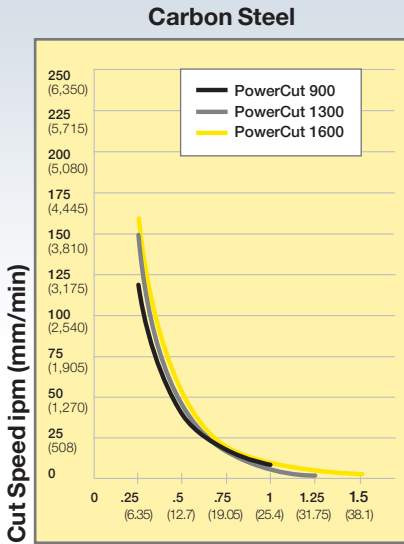

Steel Thickness, in. (mm)

Data collected using standard consumables and 80 psi Air.

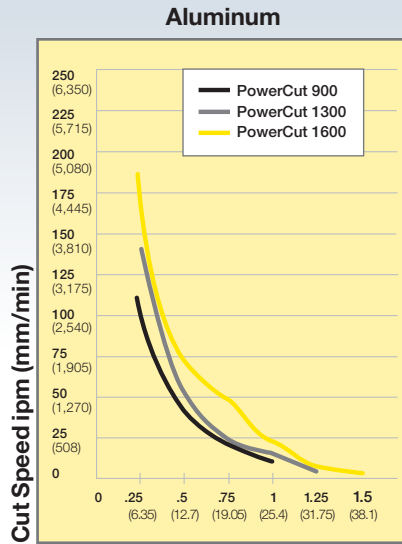

Steel Thickness, in. (mm)

Data collected using standard consumables and 80 psi Air.

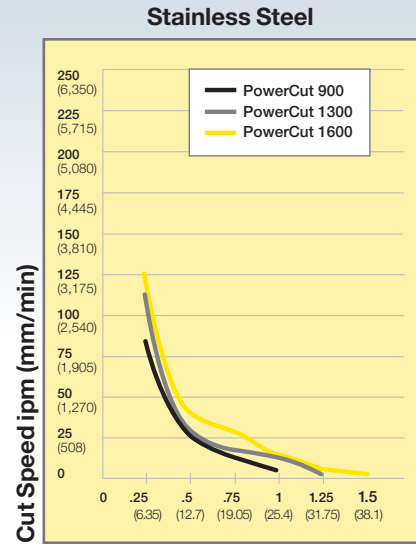

Steel Thickness, in. (mm)

Data collected using standard consumables and 80 psi Air.



Insulator	Part Number
30/70A	0558005217
90/100A	0558004870

Cutting Nozzle	Part Number
60A	0558008417
70A	0558005219
90A	0558007680
40A, drag	0558007682

Spare Parts Kit

Description	Part Number	60A - 0558008418	70A - 0558007641	90A - 0558007639
Insulator (30/70A)	0558005217	1	1	1
Insulator (90/100A)	0558004870	-	-	1
Nozzles (60A)	0558008417	3	-	-
Nozzles (70A)	0558005219	1	4	-
Nozzles (90A)	0558007680	-	-	4
Nozzles, drag (40A)	0558007682	-	1	1
Electrode	0558005220	3	3	3
Retaining shield cup assembly	0558007549	1	1	1
O-Ring .3011D .070W Nitrile	0558101101	3	3	3
Fuse SLO-BLO 2 A, 600 VDC	0558001379	1	1	1
Lubricant, 25 oz. (0.8 L)	0558000443	1	1	1

PT-39 Manual Torch



- Small profile for those hard-to-reach places
- Ergonomic handle for operator comfort
- Big face switch maximizes convenience when wearing welder's gloves
- New blowback technology
- Easily repairable in the field
- Minimum part configurations
- Molded strain relief for secure torch leads



Designed for superior cutting performance and ease of handling, the PT-39 torch produces clean, high quality cuts.

Consoles

The PT-38 can be used with the following ESAB consoles:

- PowerCut 400
- PowerCut 700

Ordering Information

PT-39 Torch Assemblies - PowerCut 400

- 15 ft. (4.5 m) lead..... 0558010576
- 25 ft. (7.6 m) lead..... 0558010577

PT-39 Torch Assemblies - PowerCut 700

- 25 ft. (7.6 m) 0558011580
- 50 ft. (15.2 m) 0558011581

Torches and torch body assemblies are supplied without electrode, nozzle, swirl baffle, and heat shield.

Options & Accessories

Spare Parts Kits

- 30A (PC 400)..... 0558010583
- 50A (PC 700)..... 0558010584
- Plasma flow measuring kit 0558000739

Torch Guide Kits

- Deluxe: 1-3/4 in. (44.5 mm) 42 in. (106 cm) radius . 0558003258
- Basic: 1-3/4 in. (44.5 mm) 28 in. (71 cm) radius . 0558002675

- Drag heat shield..... 0558010581

Specifications

PT-38	30A	50A
Cuts, in. (mm)	3/8 (9.5)	5/8 (15.9)
Severs, in. (mm)	1/2 (12.7)	3/4 (19.0)
Current capacity	50A @ 100% duty dycle	50A @ 100% duty dycle
Air supply, cfh @ psig (L/min @ bar)	300 @ 70 (141 @ 4.8)	400 @ 80 (189 @ 5.5)
Length of service leads, ft. (m)	15 (4.5)	25 (7.6)
	25 (7.6)	50 (15.2)



PT-39 Manual Torch



Carbon Steel

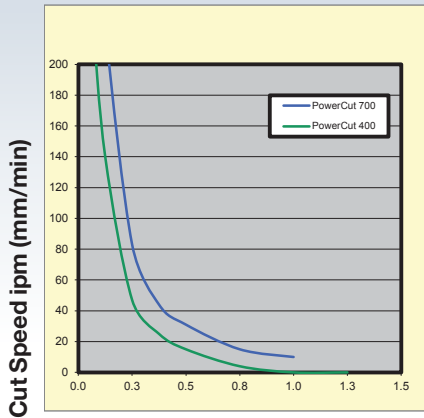

Steel Thickness, in. (mm)

Data collected using standard consumables and 80 psi Air.

Aluminum

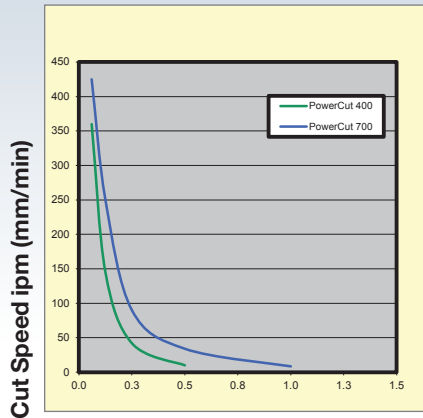

Steel Thickness, in. (mm)

Data collected using standard consumables and 80 psi Air.

Stainless Steel

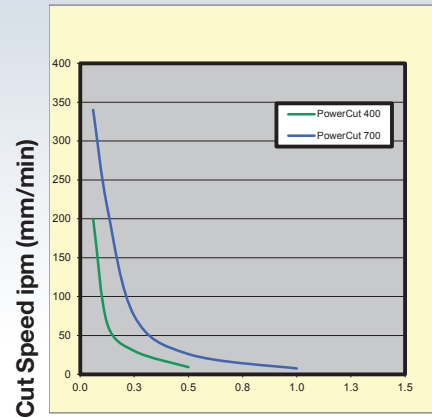

Steel Thickness, in. (mm)

Data collected using standard consumables and 80 psi Air.

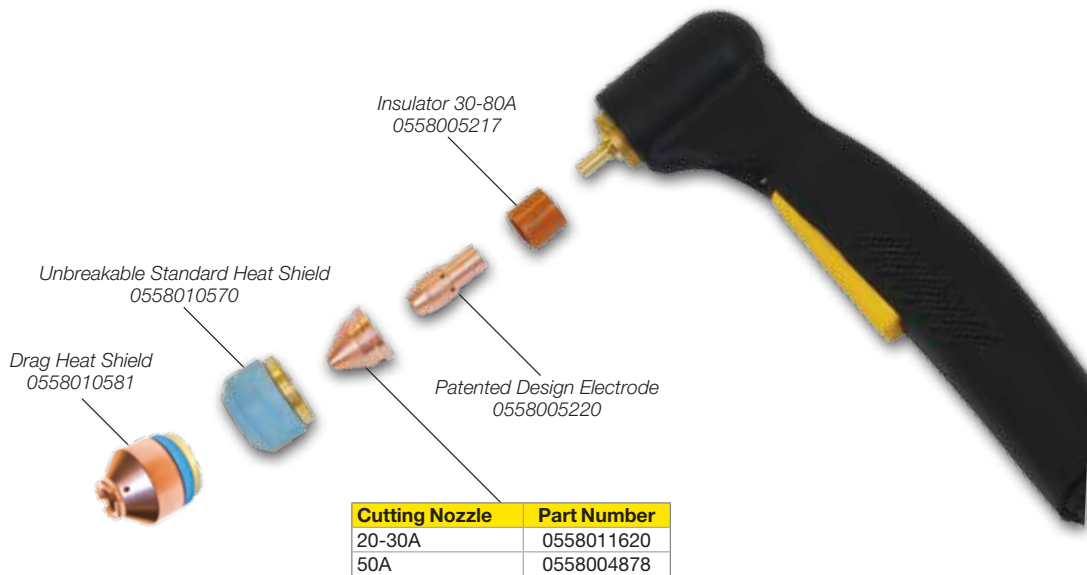

Spare Parts Kit

Description	Part Number	30A - 0558010584	50A - 0558010584
Electrode	0558005220	3	3
Insulator 30-80A	0558005217	1	1
Nozzle 20-30A	0558011620	4	-
Nozzle 50A	0558004878	-	4
Drag heat shield	0558010581	1	1
Retaining/shield cup assembly	0558010570	1	1
O-Ring, .301ID .070W Nitrile	0558101101	1	1
Lubricant, 25 oz. (0.8 L)	0558000443	1	1

PT-15XL Mechanized Torch



- Heavy-duty performance, cuts up to 6 in. (152.4 mm)
- Designed for exceptional durability
- Precision engineering
- Excellent nozzle and electrode concentricity
- 180° in-line mechanized torch
- Water cooled/water injected
- Pilot arc starting - even starts on paint
- Uses Nitrogen, Oxygen, or H-35 for plasma gas

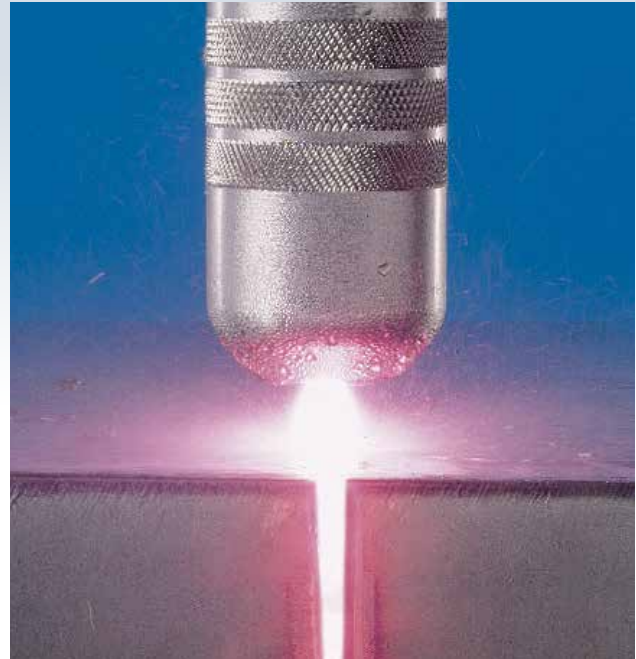

This ruggedly designed torch provides excellent performance for everyday use as part of a specially configured ESAB Smart Plasma (ESP) heavy mechanized cutting system.

Plasma Equipment

Ordering Information

PT-15XL	
4.5 ft. (1.4 m) lead.....	21307
6 ft. (1.8 m) lead.....	21304
6 ft. (1.8 m) lead, series "A"	20762
12 ft. (3.7 m) lead.....	21305
15 ft. (4.6 m) lead.....	21301
17 ft. (5.2 m) lead.....	21306
20 ft. (6.1 m) lead.....	21302
25 ft. (7.6 m) lead.....	21303
PT-15XL less leads.....	16365

Specifications

PT-15XL	
Current capacity:	
Oxygen	360A @ 100% duty cycle
Nitrogen	750A @ 100% duty cycle
Argon-Hydrogen	1000A @ 100% duty cycle
Start gas pressure, psig	100 to 125
Cut gas pressure, psig	100 to 125
Length of service leads, ft. (m)	4.5 (1.4) 6 (1.8) 12 (3.7) 15 (4.6) 17 (5.2) 20 (6.1) 25 (7.6)
Dimensions, in. (mm)	11-1/2 (292) length, 2 (50.8) barrel diameter

PT-15XL Mechanized Torch

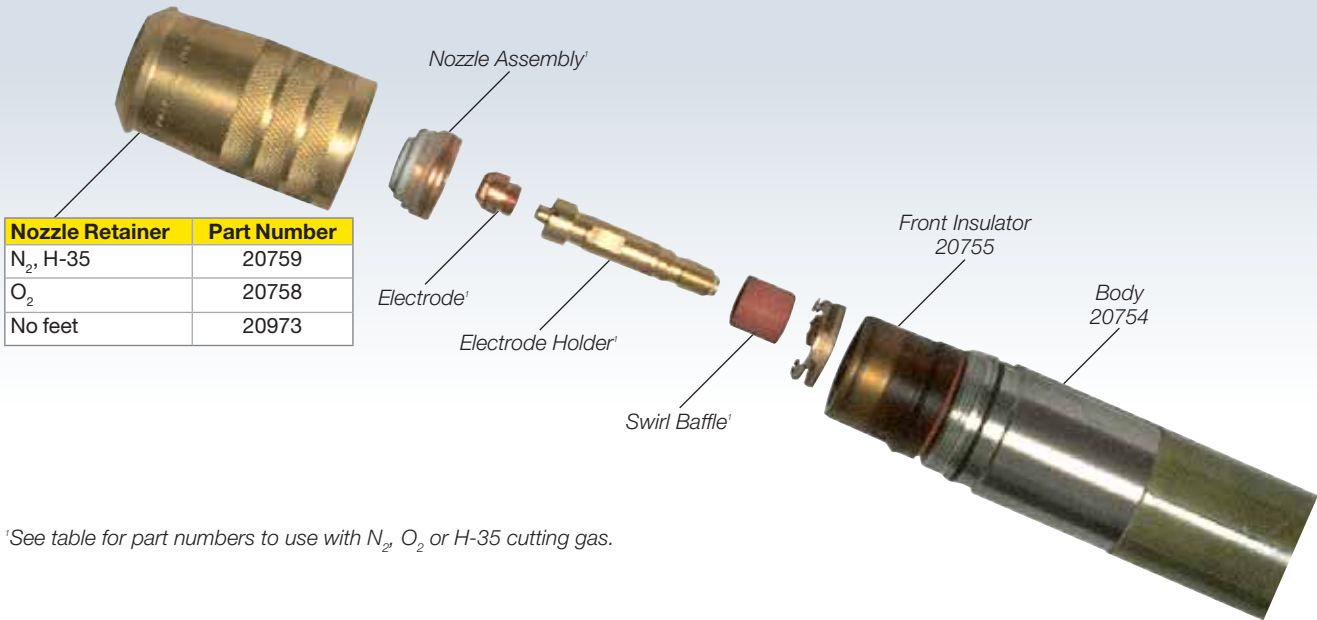

Nozzle Retainer	Part Number
N ₂ , H-35	20759
O ₂	20758
No feet	20973

*See table for part numbers to use with N₂, O₂ or H-35 cutting gas.



Process	Electrode	Electrode Holder	Nozzle Assembly			Swirl Baffles				
			Diameter, in. (mm)	Part Number	Rating	Standard	Optional			
Nitrogen with water injection	600236	2075343	.125 (3.2)	2075691	250A	4 Hole Ceramic 948142	4 Hole Plastic 2075341			
			.156 (4.0)	2075611	400A					
			.200 (5.0)	2075612	600A					
						.230 (5.8)	2075613	750A	4 Hole Reverse Ceramic 948143	4 Hole Reverse Plastic 2075360
						.125R (3.2R)	2075692	250A		
						.156R (4.0R)	2075614	400A		
						.200R (5.0R)	2075615	600A		
			.230R (5.8R)	2075690	750A					
Argon/Hydrogen H-35	600236	2075343	.250 (6.4)	2075587	875 - 1000A	8 x .067 Ceramic 2075586				
Oxygen with water injection	35666XL	20398	.07 (1.8)	37317	125A	4 Hole Ceramic 948142	None			
			.07R (1.8R)	37318		4 Hole Reverse Ceramic 948143				
	20763XL or 35666XL	20398	.099 (2.5)	20751	260A	8 x .067 Ceramic 2075586	4 Hole Ceramic 948142			
			.099 (2.5)	21206B		8 x .067 Reverse Ceramic 2075586	4 Hole Reverse Ceramic 948143			
			.099R (2.5R)	21207B						
	35666XL	20398	.099R (2.5R)	20920	300A 340A	8 x .047 Ceramic 35660	None			
			.116 (2.9)	35662		8 x .047 Reverse Ceramic 35661				
			.120 (3.0)	35664						
			.116R (2.9R)	35663						
			.120R (3.0R)	35665						

PT-19XLS Mechanized Torch



- Heavy-duty performance
- Designed for exceptional durability
- Precision engineering
- Excellent nozzle and electrode concentricity
- 180° in-line mechanized torch
- Water-cooled, not water injected (dry)
- Pilot arc starting - even starts on paint
- Uses Oxygen, Nitrogen, Argon-Hydrogen or air for plasma gas

Consoles

The PT-19XLS can be used with the following ESAB consoles:

- ESP-150
- ESP-200
- Deuce Pack 150 (special order)

Ordering Information

PT-19XLS

4.5 ft. (1.4 m) lead	37086
6 ft. (1.8 m) lead	37087
12 ft. (3.7 m) lead	37088
15 ft. (4.6 m) lead	37089
17 ft. (5.2 m) lead	37090
20 ft. (6.1 m) lead.....	37091
25 ft. (7.6 m) lead	37092
50 ft. (15.2 m) lead.....	37093
PT-19XLS less leads	37543

Use with consoles only.

Specifications

PT-19XLS	
Current capacity	360A @ 100% duty cycle 150A w/PCM-150 or PCM-1500
Cut gas consumption, cfh	35 to 260
Stand-off, in. (mm)	5/32 to 1/2 (3.96 to 12.7)
Start gas pressure, psig	100 to 125
Cut gas pressure, psig	100 to 125
Length of service leads, ft. (m)	4.5 (1.4) 6 (1.8) 12 (3.7) 15 (4.6) 17 (5.2) 20 (6.1) 25 (7.6) 50 (15.2)
Dimensions, in. (mm)	15-1/2 (388) length, 2 (50.8) barrel diameter



This ruggedly designed torch provides excellent performance for everyday use with ESAB consoles or as part of a specially configured ESP heavy mechanized cutting system.

Options & Accessories

Plasma flow measuring kit	0558000739
Remote hand control switch	680982
Spare parts kit.....	37307
Start-up kit, 200A	37508
Air curtain kit	37460
Water muffler	37439
Pilot arc adaptor to PCM 150	19497

PT-19XLS Mechanized Torch



Cutting Nozzle	Part Number
250A	21822
300A	0558002608
360A	35885
400A	22195
600A	22401

Swirl Baffle	Part Number	Notes
50-200A, Air, N ₂ , O ₂	948142	4 Hole Std
50-200A, Air, N ₂ , O ₂	948143	4 Hole Rev
250-600A, N ₂ , H-35	35660	8 x .047
250-600A, N ₂ , H-35	35661	8 x .047 Rev.
400-450A, O ₂	22194	32 x .032

Shield	Part Number
50A	21795
100 - 250A	21802
250 - 600A	21945

Electrode	Part Number
50-250A, Air, N ₂ , O ₂	34086XL
150-600A, N ₂ , H-35	22403
325-360A, Air, N ₂ , O ₂	35886XL
400-450A, O ₂	22196

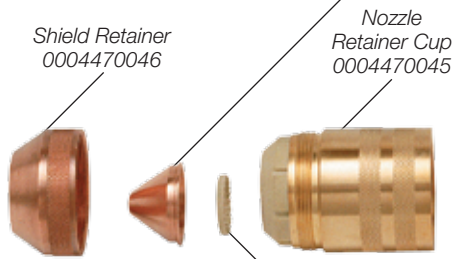

Diffuser	Part Number
50A	0004470030
100 - 600A	0004470031
250 - 600A rev.	0004470115

Nozzle Tip	Part Number
50A	22026
100A	22029
150A	22030
200A	22031
250A	22032

Nozzle Base	Part Number
50A	22027
100 - 250A	22028

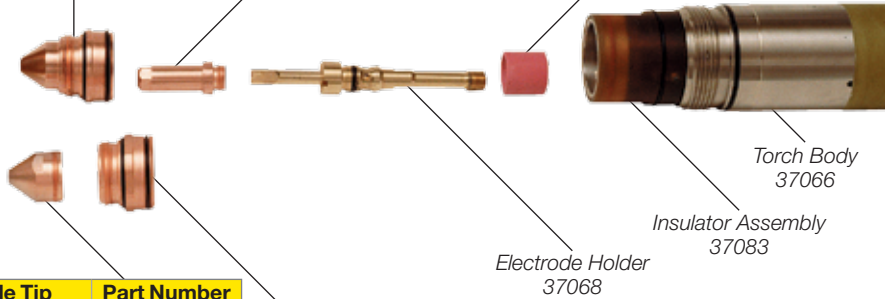

PT-20AMX/21AMX Mechanized Torch



- 180° in-line mechanical torch
- Excellent cutting capability
- Extremely versatile - excellent for thinner materials
- Equipped with patented safety interlock feature
- Pilot arc starting - even starts on paint
- Available with 50 ft. (15.2 m), 25 ft. (7.6 m), 4 ft. (1.2 m) and 17 ft. (5.2 m) torch leads¹
- Compatible with a variety of ESAB consoles
- Drops easily into standard 1 in. (34.9 mm) torch holders

¹4 ft. (1.2 m) and 17 ft. (5.2 m) torch leads used on Remote Arc Starter only.

Consoles

The PT-20AMX/PT-21AMX can be used with the following older ESAB consoles:

- PCM-875
- PCM-1125 (with adaptor 19500)
- PowerCut 1250
- PowerCut 1500
- ESP-100 (no adaptor)

Ordering Information

PT-20AMX - Console Connections

Torch with rack, 25 ft. (7.6 m).....	0558003427
Torch with rack, 50 ft. (15.2 m)	0558003421
Torch without rack, 25 ft. (7.6 m)	0558003426
Torch without rack, 50 ft. (15.2 m)	0558003422

PT-20AMX Remote Arc Starters

Torch without rack, 4 ft. (1.2 m)	0558003424
Torch without rack, 17 ft. (5.2 m)	0558003425

PT-21AMX - PowerCut 1250 & 1500

Torch with rack, 25 ft. (7.6 m).....	0558003616
Torch with rack, 50 ft. (15.2 m).....	0558003614
Torch without rack, 25ft. (7.6 m)	0558003617
Torch without rack, 50 ft. (15.2 m)	0558003615

Specifications

PT-20AMX/PT-21AMX	
Current capacity	100A @ 100% duty cycle
Plasma cutting gas requirements, cfh @ psig	350 @ 85
Plasma cutting cooling gas requirements, cfh @ psig	350 @ 85
Length of service leads, ft. (m)	4 (1.2) 17 (5.2) 25 (7.6) 50 (15.2)
Dimensions, in. (mm)	17.5 (444) length, 1-3/8 (35) barrel diameter



In conjunction with an ESAB console, the PT-20AMX torch offers the ideal solution for low cost, high performance cutting.

Options & Accessories

Torch holder assembly 16V83

Spare Parts Kits

50A	21370
70A	21369
90A	0558004271
100A	21376
Plasma flow measuring kit	0558000739

Remote Hand Control Switches, 25 ft. (7.6 m) lead

PT-20AMX	680982
PT-21AMX	0558003612

Adaptor for PCM-875 and PCM-1125 19500

PT-20AMX/21AMX Mechanized Torch



Heat Shield	Part Number
30 - 50A	21447
70 - 100A	21326

Cutting Nozzle	Part Number	Orifice Size, in. (mm)
30A	37329	.032 (0.8)
50A	21330	.042 (1.0)
70A	21329	.052 (1.3)
90A	0558004269	.056 (1.4)
100A	21328	.059 (1.5)

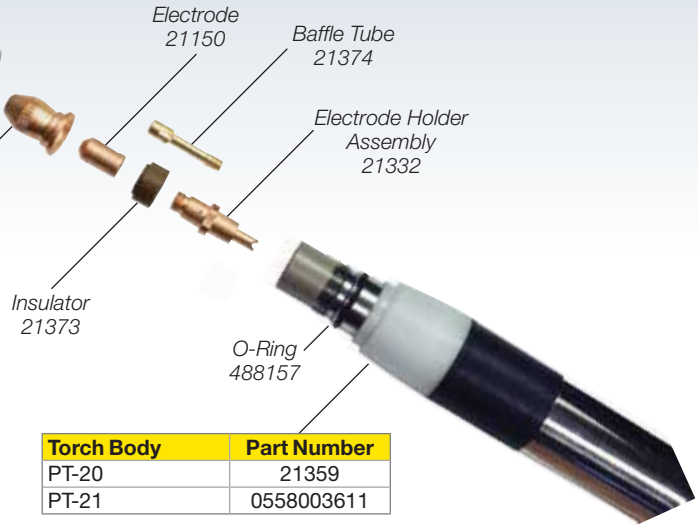

Torch Body	Part Number
PT-20	21359
PT-21	0558003611

Plasma
Equipment

Spare Parts Kit

Description	Part Number	50A - 21370	70/80A - 21369	90A - 0558004271	100A - 21376
Electrode	21150	5	5	1	5
Electrode insulator	21373	1	1	1	1
Electrode holder assembly	21332	1	1	1	1
Nozzle 50A	21330	5	5	5	5
Nozzle 70A	21329	-	5	5	5
Nozzle 90A	0558004269	-	-	5	-
Nozzle 100A	21328	-	-	-	5
Heat shield 50A	21447	2	1	1	1
Heat shield 70 - 100A	21326	-	2	2	2
Baffle tube	21374	1	1	1	1
Pilot arc adaptor	19497	1	1	5	1
Lubricant .25 oz	0558000443	1	1	1	1
O-ring	488157	5	5	1	5
Wrench, seat/baffle	21375	1	1	1	1
Wrench, 1/16 in. Hex-Key	93750006	1	1	1	1
Tool box	950272	1	1	1	1

PT-36/PT-36R Mechanized Torch



- Choose your combination of gases, speed, and cut quality
- Precision close tolerance concentricity for optimum straight or bevel cutting, with highest cut quality and consumable life
- Low current precision cutting, conventional plasma cutting, 600A thick plate cutting, and water injection cutting, with the same torch
- Posi-thread design makes it easier to install consumables, and eliminates the worry of damaged threads on electrode, electrode holder, and torch body
- Cut and mark with the same set of consumables
- Fewer consumable parts cover the entire cutting range
- Cuts carbon steel up to 3 in. thick with 450A Oxygen
- Cuts stainless steel or aluminum up to 6 in. thick with 600A Argon-Hydrogen
- Current capacity of 720A at 100% duty cycle
- Speedloader aids in consumable changes without the worries and leaks caused by O-rings, or the expense of spare torch bodies



The rugged, reliable, PT-36 torch combines up to four single-purpose torches (heavy plate cutting, precision cutting, marking, and water injection). The end result - superior cutting flexibility and productivity over a wide range of materials and thicknesses, with minimal set up time, downtime, and consumable cost. No other system offers the reliability, economy, and productivity of the m³ Plasma System.

Ordering Information

PT-36

4.5 ft. (1.4 m) torch lead.....	0558006745
6 ft. (1.8 m) torch lead.....	0558006746
12 ft. (3.7 m) torch lead.....	0558006747
15 ft. (4.6 m) torch lead.....	0558006749
17 ft. (5.2 m) torch lead.....	0558006750
20 ft. (6.1 m) torch lead.....	0558006779
25 ft. (7.6 m) torch lead.....	0558006751

PT-36 Expert Pro Bevel

14 ft. (4.3 m) torch lead.....	0558006748
--------------------------------	------------

PT-36R

4.5 ft. (1.4 m) torch lead.....	0558006811
6 ft. (1.8 m) torch lead.....	0558006812
7.2 ft. (2.2 m) torch lead.....	0558006781
12 ft. (3.6 m) torch lead.....	0558006813
15 ft. (4.6 m) torch lead.....	0558006815
17 ft. (5.2 m) torch lead.....	0558006816
20 ft. (6.1 m) torch lead.....	0558006782
25 ft. (7.6 m) torch lead.....	0558006817

PT-36R Expert Pro Bevel

14 ft. (4.3 m) torch lead.....	0558006814
--------------------------------	------------

PT-36R Direct Connect

25 ft. (7.6 m)	0558009965
50 ft. (15.2 m)	0558009967

Specifications

PT-36/PT-36R	
Current capacity:	
Air	450A @ 100% duty cycle
Oxygen	450A @ 100% duty cycle
Nitrogen	720A @ 100% duty cycle
Argon-Hydrogen	600A @ 100% duty cycle
Start gas pressure, psig	100 to 125
Cut gas pressure, psig	100 to 125
Length of service leads, ft. (m)	4.5 (1.4) 6 (1.8) 12 (3.7) 15 (4.6) 17 (5.2) 20 (6.1) 25 (7.6)
Dimensions, in. (mm)	16.7 (424) length 2 (50.8) barrel diameter

Instruction Manual, PT-36.....	0558006785
Instruction Manual, PT-36R	0558006829
Product Data Page	PAC-21210

PT-36/PT-36R Mechanized Torch



MicroNozzle Cutting

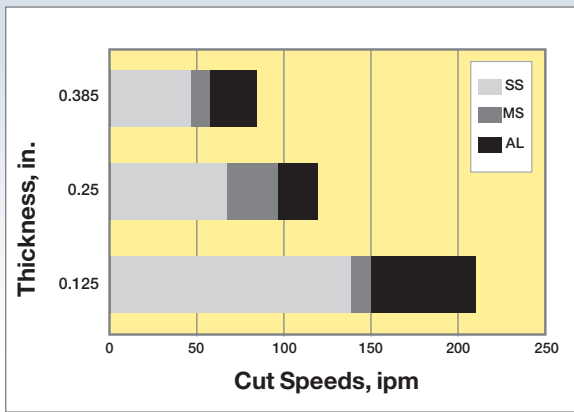

Water Injection Cutting

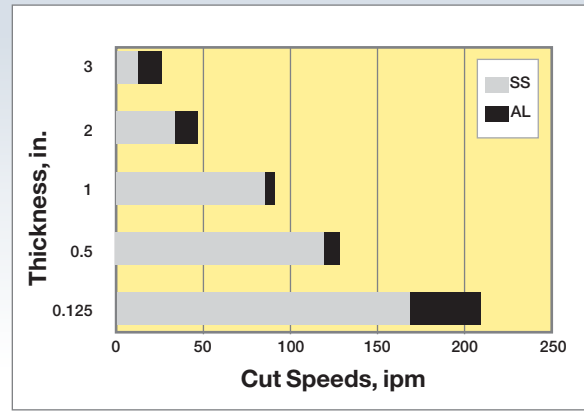

Quality Mode Cutting (EPP-200)

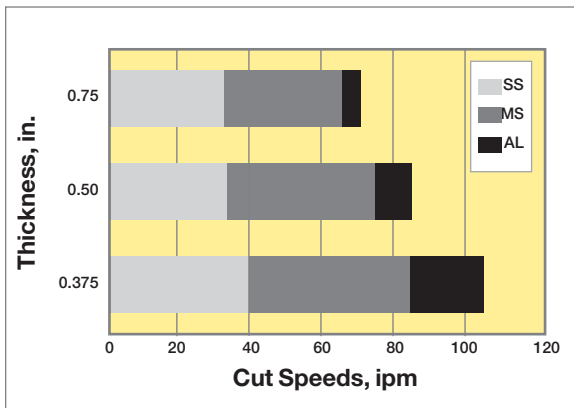

Thick Plate Cutting

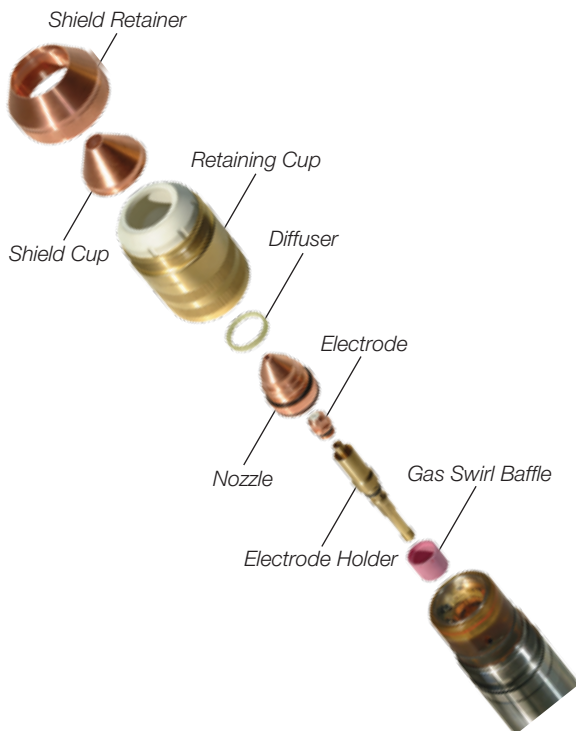
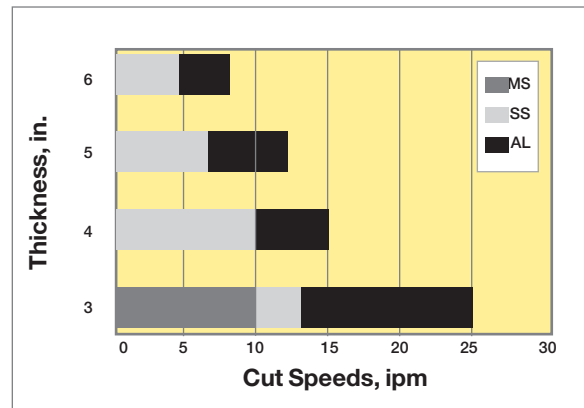

Spare Parts Kit

Description	Part Number	058005221
Torch body PT-36 w/O-Rings	0558003804	1
O-Ring 1.614 ID x .070	0004485648	10
Baffle, 4 hole x .032	0558002533	2
Baffle, 8 hole x .047	0558002530	1
Baffle, 4 x .032 reverse	0558002534	1
Baffle, 8 x .047 reverse	0558002530	1
Baffle, 4 hole x .022	0558005457	1
Electrode holder w/O-ring	0558003924	3
O-Ring .364 ID x .070	0004485671	10
Nozzle retaining cup, std.	0004470045	2
Shield gas diffuser, low current	0004470030	1
Shield gas diffuser, standard	0004470031	5
Shield gas diffuser, reverse	0004470115	1
Shield retainer, standard	0004470046	2
Contact ring w/screw	0558003858	2
Screw, contact ring	0004470044	6
Hex key wrench .109 in.	93750010	2
Nut driver 7/16 in. (electrode tool)	0558003918	1
Silicon grease DC-111 5.3 oz.	77500101	1

Instruction Manual, PT-36 0558006785
 Instruction Manual, PT-36R 0558006829
 Product Data Page PAC-21210

Plasma
Equipment



PT-37 Mechanized Torch



- 100% duty cycle for enhanced productivity allowing for continuous operation even at maximum thickness
- Utilizes a “drawn arc” to initiate the cut, which eliminates high frequency interference from the starting circuits
- An optional remote starting system allows the torch to be located up to 150 ft. (45 m) away from the power supply
- Machined torch body with 1-3/8 in. (35 mm) metal handle, available with and without 32-pitch rack to fit industry standard torch holders
- Robust machined torch components provide for reliability, durability, and ease of maintenance
- Metal nozzle and shield stand up to the toughest cutting conditions
- Wear parts are available individually, in sets, and in value packs, which eases ordering and saves money



Consoles

The PT-37 can be used with the following ESAB consoles:

- PowerCut 900
- PowerCut 1300
- PowerCut 1600
- ESP-101

The patented PT-37 torch cuts up to 1-1/4 in. (32 mm) material using air as the plasma and shielding gas. Utilizing a blowback start, and an electronically controlled pilot arc, the PT-37 sets a new standard for starting reliability, cutting characteristics, and consumable life.

Ordering Information

PT-37 Torches with Rack

4.5 ft. (1.3 m)	0558004860
17 ft. (5.2 m)	0558004861
25 ft. (7.6 m)	0558004862
50 ft. (15.2 m)	0558004863

PT-37 Torches without Rack

4.5 ft. (1.3 m)	0558004894
17 ft. (5.2 m)	0558004895
25 ft. (7.6 m)	0558004896
50 ft. (15.2 m)	0558004897

Options & Accessories

Remote Hand Switches

25 ft. (7.6 m)	0558005548
50 ft. (15.2 m)	0558005549

Remote Junction Box, Extension Hoses & Cables

Remote junction box (RJB)	0558004887
Hose/cable bundle RJB 50 ft. (15.2 m).....	0558004888
Hose/cable bundle RJB 100 ft. (30 m).....	0558004889
Torch holder, manually adjustable, 32 pitch rack..	0558005926
Plate rider assembly	2238229

Specifications

PT-37	
Cuts, in. (mm)	3/4 (19)
Severs, in. (mm)	1-1/4 (32) max.
Current capacity	100A @ 100% duty cycle
Nominal flow rate, with 100A consumables, cfh @ psig (L/min @ bar)	490 @ 80 (231 @ 5.5)
Length of service leads, ft. (m)	4.5 (1.4)
	17 (5.2)
	25 (7.6)
	50 (15.2)
Dimensions, in. (mm)	18.1 (460) length

PT-37 Mechanized Torch



Carbon Steel

50 Amps

Plasma Gas: Air @ 70 psi (4.8 bar)

Thickness in. (mm)	Initial Height in. (mm)	Pierce Height in. (mm)	Cutting Height (standoff) in. (mm)	Arc Voltage	Pierce Time (milliseconds)	Kerf Width in. (mm)	Optimum ipm (mm/min)	Maximum ipm (mm/min)
0.062 (1.6 ga)	0.200 (5.1)	0.200 (5.1)	0.062 (1.6)	118	0	0.040 (1.0)	375 (9,525)	350 (10,160)
0.125 (3.2)	0.200 (5.1)	0.200 (5.1)	0.090 (2.3)	127	100	0.058 (1.5)	150 (3,810)	194 (4,928)
0.188 (4.8)	0.200 (5.1)	0.200 (5.1)	0.094 (2.4)	129	100	0.062 (1.6)	90 (2,286)	130 (3,302)
0.250 (6.4)	0.200 (5.1)	0.200 (5.1)	0.125 (3.2)	133	150	0.068 (1.7)	65 (1,651)	85 (2,159)
0.375 (9.5)	0.200 (5.1)	0.250 (6.4)	0.120 (3.0)	139	200	0.068 (1.7)	35 (889)	45 (1,143)
0.500 (12.7)	0.200 (5.1)	0.250 (6.4)	0.077 (1.8)	145	400	0.072 (1.8)	20 (508)	27 (686)
0.625 (15.9)	0.200 (5.1)	0.275 (7.0)	0.075 (1.9)	151	950	0.075 (1.9)	10 (254)	12 (305)

70 Amps

Plasma Gas: Air @ 80 psi (5.5 bar)

Thickness in. (mm)	Initial Height in. (mm)	Pierce Height in. (mm)	Cutting Height (standoff) in. (mm)	Arc Voltage	Pierce Time (milliseconds)	Kerf Width in. (mm)	Optimum ipm (mm/min)	Maximum ipm (mm/min)
0.125 (3.2)	0.200 (5.1)	0.200 (5.1)	0.093 (2.4)	125	0	0.051 (1.3)	225 (5,715)	275 (6,985)
0.250 (6.4)	0.200 (5.1)	0.240 (6.1)	0.156 (4.0)	139	250	0.066 (1.7)	93 (2,362)	128 (3,251)
0.375 (9.5)	0.200 (5.1)	0.240 (6.1)	0.215 (5.5)	146	350	0.076 (1.9)	50 (1,270)	65 (1,651)
0.500 (12.7)	0.200 (5.1)	0.280 (7.1)	0.200 (5.1)	152	450	0.088 (2.2)	32 (813)	45 (1,143)
0.625 (15.9)	0.200 (5.1)	0.280 (7.1)	0.188 (4.8)	160	900	0.093 (2.4)	22 (559)	27 (686)
0.750 (19.1)	0.200 (5.1)	-	0.156 (4.0)	160	-	0.107 (2.7)	12 (305)	16 (406)

100 Amps

Plasma Gas: Air @ 80 psi (5.5 bar)

Thickness in. (mm)	Initial Height in. (mm)	Pierce Height in. (mm)	Cutting Height (standoff) in. (mm)	Arc Voltage	Pierce Time (milliseconds)	Kerf Width in. (mm)	Optimum ipm (mm/min)	Maximum ipm (mm/min)
0.250 (6.4)	0.188 (4.8)	0.188 (4.8)	0.092 (2.3)	138	100	0.075 (1.9)	77 (1,956)	100 (2,540)
0.375 (9.5)	0.188 (4.8)	0.188 (4.8)	0.156 (4.0)	149	300	0.090 (2.3)	44 (1,118)	56 (1,422)
0.500 (12.7)	0.188 (4.8)	0.240 (6.1)	0.156 (4.0)	153	300	0.100 (2.5)	57 (1,448)	70 (1,778)
0.625 (15.9)	0.188 (4.8)	0.240 (6.1)	0.156 (4.0)	156	400	0.110 (2.8)	40 (1,016)	45 (1,143)
0.750 (19.1)	0.200 (5.1)	0.300 (7.6)	0.125 (3.2)	155	1200	0.105 (2.7)	26 (660)	35 (889)
1.000 (25.4)	0.250 (6.4)	-	0.080 (2.0)	155	-	0.120 (3.0)	16 (406)	20 (508)
1.250 (31.8)	0.250 (6.4)	-	0.062 (1.6)	159	-	0.120 (3.0)	10 (254)	13 (330)

Plasma
Equipment



PT-37 Mechanized Torch

PT-37 Consumables, Kits & Sets

Start Up Consumable Kits

100A	0558004883
70A	0558008247
60A	0558008248

Consumable Sets

50A (1 nozzle, 1 electrode)	0558004884
100A (1 nozzle, 1 electrode)	0558004885
Value Pack 100A (15 nozzles, 10 electrodes) ..	0558004886

Electrodes

Silver	0558004875
Standard	0558005220

Both electrodes can be used for the full range of cutting.
 Silver electrode provides longer consumable life for higher duty cycle, automated applications. It is recommended for mechanized cutting above 50 amps.

Swirl Baffles

30-70A	0558005217
100A	0558004870

Nozzles

30A	0558005218
50A	0558004878
70A	0558005219
100A	0558004879

Nozzle retainer	0558006600
-----------------------	------------

Shields

100A	0558006601
50-70A	0558006602
30-40A	0558006603

Plasma
Equipment

Cutting Nozzle	Part Number
30A	0558005218
50A	0558004878
70A	0558005219
100A	0558004879

Nozzle Retainer
0558006600

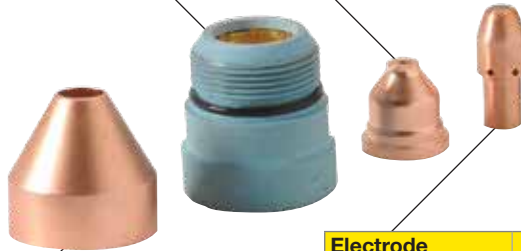

Swirl Baffle	Part Number
30 - 70A	0558005217
100A	0558004870

Electrode	Part Number
50A, Standard	0558005220
100A, Long Life	0558004875

Shield	Part Number
30 - 40A	0558006603
50 - 70A	0558006602
100A	0558006601



PT-600 Mechanized Torch



- Precision engineering for heavy-duty performance
- Excellent nozzle and electrode concentricity
- 180° in-line mechanized torch
- Pilot arc starting - even starts on paint
- Uses Oxygen, Nitrogen, Argon-Hydrogen or air for plasma gas, Nitrogen, Argon-Hydrogen or air for start gas, and Nitrogen or air for secondary shield gas

Spare Parts Kit

Description	Part Number	0558002479
Electrode 250A	0558001624	5
Electrode 360 - 400A	0558002516	2
Electrode N ₂ , H-35	0558002499	2
Electrode holder tool	0558004611	1
Electrode tip tool	0558007105	1
Electrode holder w/o O-ring	0558001621	1
Nozzle 50A	0558001881	2
Nozzle 100A	0558001882	2
Nozzle 150A	0558001883	2
Nozzle 200A	0558001884	5
Nozzle 250A	0558001623	5
Nozzle 360A	0558001885	5
Nozzle 400A	0558001886	2
Nozzle 600A	0558001887	2
Nozzle retaining clip	0004470045	1
Baffle 4 Hole	0558002533	2
Baffle 8 Hole	0558001625	2
Baffle 32 Hole	0558002532	1
Baffle 4 Hole rev.	0558002534	1
Baffle 8 Hole rev.	0558002530	1
Baffle 32 Hole rev.	0558002531	1
Gas Diffuser 50A	0004470030	1
Gas Diffuser 100 - 360A	0004470031	1
Gas Diffuser 100 - 360A rev.	0004470115	1
Lubricant .25 oz	0558000443	1
O-Ring	0004485648	5
O-Ring	0004485671	5
O-Ring, nozzles	0004470034	5
Shield 50A	21795	2
Shield 260A	21802	5
Shield 360A	21945	2
Shield retainer	0004470046	1
Contact ring assembly	0558003858	1
Contact ring screw	0004470044	1



Plasma Equipment

The PT-600 torch is precision engineered for close tolerance concentricity, making it ideal for straight or bevel cutting, and providing the highest possible cut quality and consumable life.

Ordering Information

PT-600

4.5 ft. (1.4 m) torch lead	0558001827
6 ft. (1.8 m) torch lead.....	0558001828
12 ft. (3.7 m) torch lead.....	0558001829
15 ft. (4.6 m) torch lead.....	0558001830
17 ft. (5.2 m) torch lead.....	0558001831
20 ft. (6.1 m) torch lead.....	0558001832
25 ft. (7.6 m) torch lead.....	0558001833

Specifications

PT-600	
Current capacity:	
Air	200A @ 100% duty cycle
Oxygen	400A @ 100% duty cycle
Nitrogen	600A @ 100% duty cycle
Argon-Hydrogen	600A @ 100% duty cycle
Start gas pressure, psig	100 to 125
Cut gas pressure, psig	100 to 125
Length of service leads, ft. (m)	4.5 (1.4) 6 (1.8) 12 (3.7) 15 (4.6) 17 (5.2) 20 (6.1) 25 (7.6)
Dimensions, in. (mm)	10-1/2 (266) length 2 (50.8) barrel diameter

Plasmarc Accessories



Remote Hand Switch



Deluxe Torch Guide Kit



Basic Torch Guide Kit

Remote Hand Switches

- Allows the operator to start and stop the cutting process with a remote switch
- Used primarily for mechanized cutting and is included in the mechanized Plasmarc packages

PT-20AMX.....	680982
ESP-150/ESP-200.....	2075600
PT-21AMX.....	0558003612
PT-37, 25 ft. (7.6 m).....	0558008349
PT-37, 50 ft. (15.2 m).....	0558009277

Torch Guide Kits

- Includes attachments for circle and straight line cutting on ferrous and non-ferrous metals

Deluxe: 1-3/4 in. (44.5 mm) 42 in. (106 cm) radius... 0558003258
 Basic: 1-3/4 in. (44.5 mm) 28 in. (71 cm) radius... 0558002675



Torch shown with Plasmit

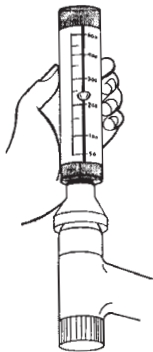

Plasma Flow Measuring Kit

Plasma Flow Measuring Kit

- Valuable troubleshooting tool
- Allows measurement of actual plasma gas flow through torch

Plasma flow measuring kit	0558000739
---------------------------------	------------

Plasmits

- Special flexible shields attach around the head of a plasma cutting torch to provide added protection against heat and molten metal
- Recommended for heavy-duty plasma gouging applications

PT-121	
75° torch	20742
90° torch	20801
Mechanized torch	20802

PT-25	
90° torch	20801
175° torch	20805

PT-26	
70° torch	0558006717
90° torch	0558006718

PT-17A manual torch	20803
PT-32EH	0558007989

Plasmarc Accessories

Leather Sheath

- A leather sheath to protect torch leads from abrasion and molten metal
- Particularly recommended for plasma gouging
- For use with any ESAB Plasmarc torch

Leather Sheath with Snaps

10 ft. (3 m)	20812
25 ft. (7.6 m)	0558002921
50 ft. (15.2 m)	0558002922

Replacement Bushings

- Used for torch guide kits

Adaptor

PT-23/27 bushing	TJ2225
PT-25 bushing.....	TJ2230
PT-31XL bushing	TJ2228
PT-32 bushing.....	0558003257

Torch Coolant

50% EG torch coolant.....	0560950312
---------------------------	------------

Utility Cart for PowerCut Series

- This enables easy transport of the PowerCut Series Machines

Utility cart..... 0558007898



Utility Cart for PowerCut Series



Gas Apparatus



Gas Apparatus

Table of Contents



Gas Apparatus - Safety, Durability, Performance	140
Gas Apparatus Processes	141
Gas Apparatus Product Cross-Reference Guide	142

Outfits

PUROX Elite Series Outfits Product Offering Guide ...	144
Metal Master Select Cutting Outfit	145
Metal Master Champion Cutting & Heating Outfit	145
Flamemaster Cutting & Heating Outfit	146
Metal Master II Cutting & Welding Outfit	147
Metal Master III Cutting, Heating & Welding Outfit	147

Torches

Torches Product Offering Guide	148
Combination Torches	149
OXWELD W-17/CW-23	150
PUROX Elite Series WH-4200/CA-4200	152
OXWELD C-66 with Universal Injector	154
OXWELD C-32 with Universal Mixer	155
OXWELD SCT-1500 & PUROX® SCT-4200	156
OXWELD C-67 Machine Cutting Torch	157
OXWELD C-39, C-58, C-69/70 Machine Cutting Torch	158
CM-79 Portable Cutting Machine	159
Pressure Drops in Hose	160
Accessories	164

Cutting Tips

Cutting Tips Product Offering Guide	168
OXWELD, PUROX, Victor Style Cutting Tips	169
1502 Series	170
1564 Series Propylene Tips	171
1515 Series Natural Gas & Propane Tips	172
1566 Series Alternate Fuels High Speed Tips	173
1567 Series	174
1539 Series Alternate Fuels Tips	175
1516 Series Acetylene Tips	175
1510 Series Acetylene Tips	176
1511, 1520 & 1568 Tips	176
4202 Series Acetylene Tips	177
4216 Series Propylene Tips	177
4203 Series Natural Gas & Propane Tips	178
4217 Series	179
4206 Series Acetylene Tips	180
4207 & 4218 Tips	180
4209 Series Acetylene Tips	180
Victor Style Cutting Tips	181

Regulators

Regulators Product Offering Guide	182
Cylinder Regulators	183
R-770 Series - Cylinder	186
R-760 Series - Cylinder	187
R-720 Series - Cylinder	188
R-760-CF-320 Carbon Dioxide	189
R-720-CF-580 and R-720-FM-580	189
R-5007-FM-580/R-5008-FM-320 and R-502-FM-580	189
R-33 and R-50 Series Regulator/Flowmeter	190
L-32/L-33 Flowmeters	191
R-760 OXWELD Elite Series Extra Heavy-Duty	192

R-720 PUROX Elite Series Medium/Heavy-Duty	192
R-6700 OXWELD High-Capacity	192
Replacement Gauges	194
Valves	196

Steel Industry Products

Steel Industry Products	199
Steel Industry Products Product Offering Guide	200
C-59 Scarfing/Cutting Torch	201
OXWELD C-63	202
C-66-1400 Series	202
OXWELD PM-GST	202
OXWELD C-67-1400, C-43E	203
OXWELD PM-100, PM-200 & PM-300	203
OXWELD C-60, C-100	203
V-24 Oxygen Lance	204
1400 Series Alternate Fuels	205
1702 Series Alternate Fuels	206
1808 Series Alternate Fuels	207
PM Tips Alternate Fuels	208
C-100 Tips Alternate Fuels	209
1806 Series Alternate Fuels	209
AC-4 Powder Cutting Hand Torches	210
Powder Attachments for Standard OXWELD Torches	210
AC-4 Powder Cutting Tips	210
Powder Equipment	211
High Pressure Regulators	212
High Capacity Industrial Gas Regulators	212
Regulation Panels	213
Regulation Supply Lines	214
H-14 & H-16 Dry Type Protective Devices	215
Filters, Check/Relief/Dual Shutoff Valves	216
Valves	217

PREST-O-LITE

GT-200 Cutting Outfit	218
Precision Master Welding & Cutting Outfit	218
Maintenance Welding & Cutting Outfit	219
POL Brazing Welding Outfit	219
PREST-O-LITE W-200/CW-200	220
4-in-1 Outfit with Soft Flame Tips	221
Swirljet Outfit	221
General Purpose Air-Acetylene Outfits with Soft Flame Tip	222
Silversmith Outfit with Soft Flame Tip	222
Model 403 Torch Handle	224
POL Standard Torch Tips	224
POL Swirljet Tips	225
X-3B POL Kit and X-4B POL Kit	226
X-5B POL Kit and X-6MC POL Kit	227
PZ-5A "MC" Kit	228
Air Acetylene, Swirl Flame, Auto-Ignite Tips	229
Acetylene Swirljet Tips - Quick Disconnect	230
Fuel Gas Swirljet Tips - Quick Disconnect	230
PZ-503 & Accessories	231
R-411, R-22, R-36 Pressure Regulators	232
Regulator Replacement Gauges	233
PREST-O-LITE Adaptors	234
PREST-O-LITE Accessories	235

Gas Apparatus

Safety. Durability. Performance. Guaranteed.

An American Tradition

ESAB's OXWELD®, PUROX® Elite Series, and PREST-O-LITE® gas apparatus is engineered, assembled, and tested in Florence, SC, USA - and has been for more than 45 years.



ESAB's Lifetime Warranty

ESAB's gas apparatus Lifetime Warranty applies to OXWELD, PUROX Elite Series, and PREST-O-LITE standard torches, regulators, and flowmeters. The warranty covers manufacturer defects in materials and workmanship.



To make a warranty claim, please call 1.800.ESAB.123, or visit esabna.com/lifetimewarranty.

Gas Apparatus



ENGINEERED



ASSEMBLED



TESTED

Number One in Quality

The OXWELD, PUROX Elite Series, and PREST-O-LITE welding and cutting product lines have achieved world-class quality through Total Quality Control, which includes the commitment of every member of our team.

Our employees - from the CEO to the men and women on the production line - are provided with the knowledge and skills they need to act as guardians of quality. We've put systems in place to recognize and correct mistakes before a product reaches your hands. And our quality control efforts cover every step, from product development to production to customer service.

Gas Apparatus Processes

In oxyfuel gas welding, heating, and cutting, an intense flame is produced by burning a controlled mixture of oxygen and a fuel gas. The gases are drawn from separate sources through pressure regulators and introduced into a torch for mixing. The gases then exit the welding head or cutting tip, where they are ignited. Flame intensity depends on the flow rates of the gases, the gas mixture ratio, the properties of the fuel gas selected, and the type of welding head or cutting tip. Flow rates and mixture ratios are controlled by the regulator pressure settings and by the torch valves.

Welds are formed from the weld puddle created through contact of flame, workpiece, and welding rod, if used. Use of flux removes oxide and scale from the welding area and helps assure a sound weld. In cutting operations, a concentrated flame is used to preheat and maintain the workpiece at its ignition temperature while a high-velocity stream of oxygen is directed at the preheated plate. The oxygen stream rapidly oxidizes the metal in a narrow path and blows away the slag to form the kerf.

Basic equipment necessary for oxyfuel gas welding and cutting includes a torch with welding heads, cutting attachment, and cutting tips; oxygen and fuel gas hoses; oxygen regulator; and acetylene or other fuel gas regulator. Always comply with the instructions listed in the operator's manual provided with each piece of equipment.

The Oxy-Acetylene Handbook

For nearly five decades, the most comprehensive and widely used reference and textbook on oxy-acetylene welding, cutting, hard-facing, surfacing, and heating applications.

Soft Cover Binding..... 781F00
 CD 782F23

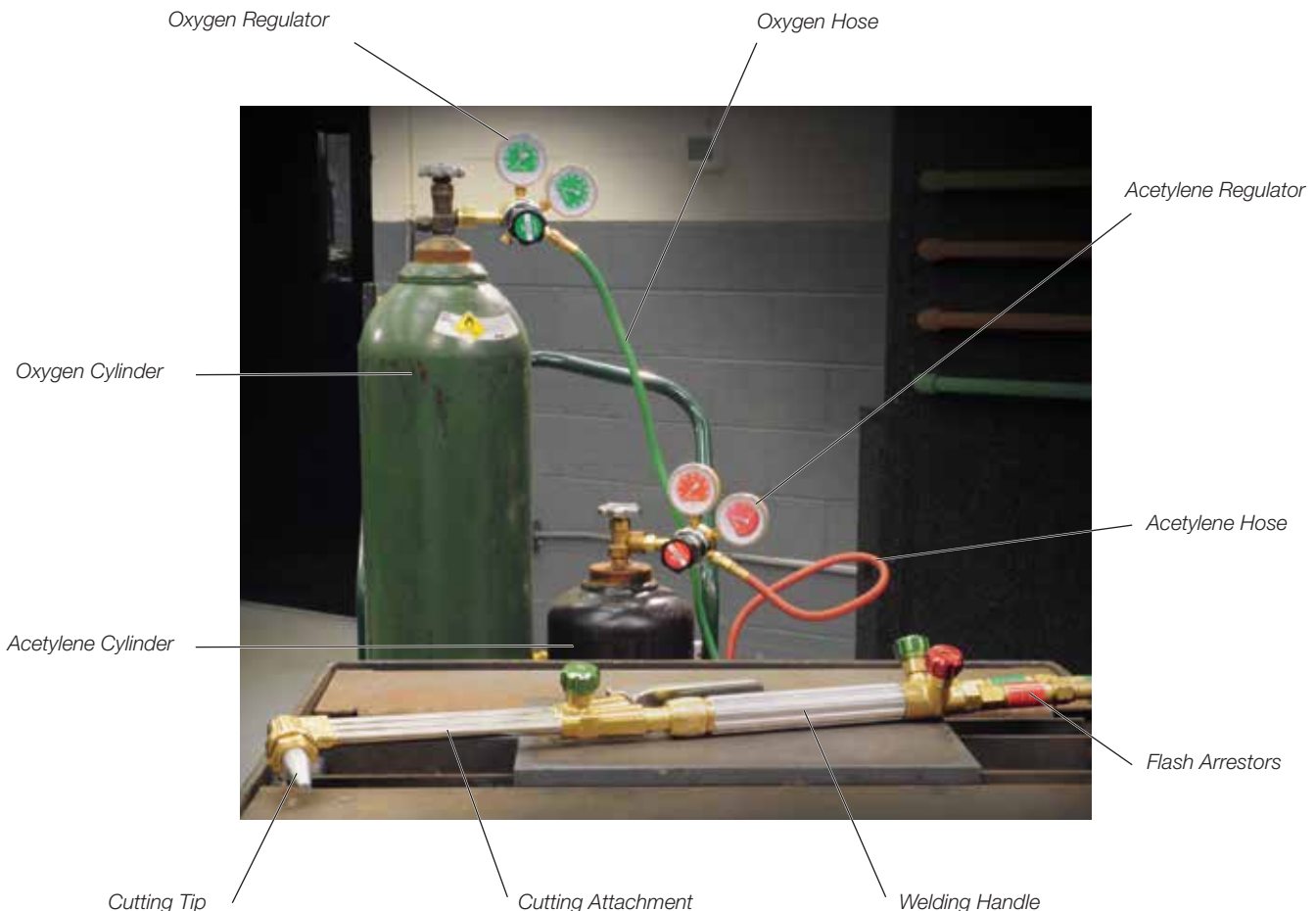

Gas Apparatus

Product Cross-Reference Guide

Outfits

Used to order OXWELD:	Part Number
Trade Master GT II	0558008687
Trade Master	18835
GT-450	21992
GT-510	0558005108

Now order PUROX Elite Series ¹	Part Number
Metal Master Champion	0558011398
Metal Master III	0558011392
Metal Master Select	0558011393
Metal Master Champion	0558011398

Used to order PUROX:	Part Number
Metal Master GT II	0558008691
Trade Master	999995
GT-350	21777
GT-510	0558005107
Flamemaster 300	22497

Now order PUROX Elite Series ¹	Part Number
Metal Master Champion	0558011398
Metal Master III	0558011392
Metal Master Select	0558011393
Metal Master Champion	0558011398
Flamemaster	0558011650

Combination Torches

Used to order OXWELD:	Part Number
W-17	4250
W-500	999079
W-400	999045
CW-23	01X36
CW-500	999220
CW-400	999046

Now order Elite Series ¹ :	Part Number
W-17 (no change)	4250
***	***
WH-4200	0558010617
CW-23 (no change)	01X36
***	***
***	***

Used to order PUROX:	Part Number
W-300	999339
CW-300	999340

Now order PUROX Elite Series ¹ :	Part Number
WH-4200 ²	0558010617
CA-4200 ²	0558010614

¹This column represents our closest recommended replacement, but is not necessarily an exact cross reference, backwards compatible, or takes the same repair parts unless otherwise noted.

²Backwards compatible with previous items' consumables.

***Please call 1.800.ESAB.123 to confirm.



Gas Apparatus

Product Cross-Reference Guide

Straight Cutting Torches

Used to order OXWELD:	Part Number
C-32	01X26
C-66	27X71
C-97	22054
C-77	28X55



Now order OXWELD Elite Series':	Part Number
C-32 (no change)	01X26
C-66'	27X71
C-66'	27X71
SCT-1500	0558011950

'No change; now compatible with all fuel gas.

Used to order PUROX:	Part Number
"E" Torch	04L06
C-84	18260



Now order PUROX Elite Series':	Part Number
SCT-4200	0558011669
***	***

Mechanized Torches

Used to order OXWELD:
C-39
C-58
C-67
C-69/C-70



Now order OXWELD':
C-39 (no change)
C-58 (no change)
C-67 (no change)
C-69/C-70 (no change)

Regulators

Used to order OXWELD:
R-77
R-76



Now order OXWELD Elite Series':
R-770
R-760

Used to order PUROX:
R-72
R-33



Now order PUROX Elite Series':
R-720
R-33 (no change)

'This column represents our closest recommended replacement, but is not necessarily an exact cross reference, backwards compatible, or takes the same repair parts unless otherwise noted.

****Please call 1.800.ESAB.123 to confirm.*

Gas Apparatus

PUROX® Elite Series Outfits

Product Offering Guide



Cutting

Metal Master Select

- 1 cutting tip
- Acetylene
CGA 510
CGA 300
- Alternate fuels
CGA 510



Cutting & Welding

Metal Master II

- 1 cutting tip
- 1 welding head
- Acetylene
CGA 510



Cutting & Heating

Metal Master Champion

- 1 cutting tip
- 1 heating head
- Acetylene
CGA 510



Cutting, Heating & Welding

Metal Master III

- 1 cutting tip
- 1 heating head
- 2 welding heads
- Acetylene
CGA 510



FlameMaster

- 3 cutting tips
- 1 heating head



PUROX® Elite Series Outfits



Metal Master Select Cutting Outfit

- Acetylene (CGA 510 or 300 option)
- Alternate fuels (CGA 510)
- Cuts 1-1/2 in. (38 mm); with optional tips 8 in. (203 mm)
- Minimal components keep price low
- 3 versions for fuel gas flexibility
- Elite Series combo torch and regulators
- Regulator Burnout Protection (RBO)
- Universal swirl injector for flexibility



Ordering Information

Metal Master Select	0558011393
Metal Master Select FG	0558011394
Metal Master Select 300	0558011395

Contents

CA-4200 cutting attachment	0558010614
WH-4200 welding handle	0558010617
R-720 acetylene (15-510) regulator	0558010648
OR acetylene (15-300) regulator	0558010649
OR alternate fuel (75-510) regulator	0558010650
R-720 oxygen (125-540) regulator	0558010651
4202, 1-1/2 in. (38 mm) cutting tip, acetylene	16K10
OR 4217, 1 in. (25.4 mm) cutting tip, alternate fuel	0558005125
Hose	22556
Striker	790F34
Goggles	17862

Gas Apparatus

Metal Master Champion Cutting & Heating Outfit

- Acetylene (CGA 510)
- Cuts 1-1/2 in. (38 mm); with optional tips 8 in. (203 mm)
- Heats 44,000 btu/hr using 30 cfh acetylene; with optional tips 294,000 btu/hr using 200 cfh acetylene
- Designed for cutting and heating applications
- Elite Series combo torch and regulators
- Regulator Burnout Protection (RBO)
- Universal swirl injector for flexibility



Ordering Information

Metal Master Champion	0558011398
-----------------------------	------------

Contents

CA-4200 cutting attachment	0558010614
WH-4200 welding handle	0558010617
R-720 acetylene (15-510) regulator	0558010648
R-720 oxygen (125-540) regulator	0558010651
#30 Rosebud Jr. heating head, acetylene	0558006160
4202 1-1/2 in. (38 mm) cutting tip, acetylene	16K10
Hose	22556
Striker	790F34
Goggles	17862

PUROX® Elite Series Outfits



Flamemaster Cutting & Heating Outfit

- Cuts 4 in. (102 mm); with optional tips
8 in. (203 mm)
- Heats 44,000 btu/hr. using 30 cfh acetylene;
with optional tips 294,000 btu/hr. using
200 cfh acetylene
- Welding handle, cutting attachment and tips
- Ideal conversion kit for those not needing
regulators or a hose
- Comes with tips and heads for use with acetylene
- Universal swirl injector for flexibility

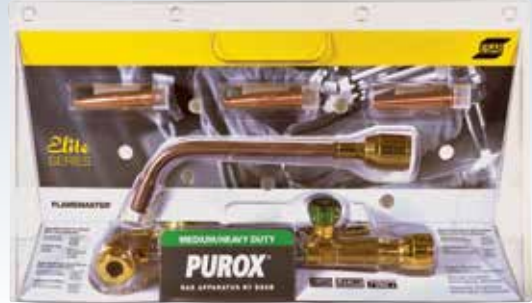

Ordering Information

Flamemaster 0558011650

Contents

CA-4200 cutting attachment	0558010614
WH-4200 welding handle	0558010617
4202, 1/2 in. (13 mm) cutting tip, acetylene	16K09
4202, 1-1/2 in. (38 mm) cutting tip, acetylene	16K10
4202, 4 in. (102 mm) cutting tip, acetylene	16K11
#30 Rosebud Jr. heating head, acetylene	0558006160

PUROX® Elite Series Outfits



Metal Master II Cutting & Welding Outfit

- Acetylene (CGA 510)
- Cuts 1-1/2 in. (38 mm); with optional tips 8 in. (203 mm)
- Welds 1/8 in. (3.2 mm) using 9 cfh acetylene; with optional tips 1 in. (25.4 mm) using 70 cfh acetylene
- Designed for cutting and welding applications
- Elite Series combo torch and regulators
- Regulator burnout protection (RBO)
- Universal swirl injector for flexibility
- Surpasses competition in performance, warranty, and quality



Contents

CA-4200 cutting attachment	0558010614
WH-4200 welding handle	0558010617
R-720 acetylene (15-510) regulator	0558010648
R-720 oxygen (125-540) regulator	0558010651
4202, 1-1/2 in. (38 mm) cutting tip, acetylene	16K10
#9 welding head, acetylene	639442
Hose	22556
Striker	790F34
Goggles	17862

Ordering Information

Metal Master II 0558011399

Metal Master III Cutting, Heating & Welding Outfit

- Acetylene (CGA 510)
- Cuts 1-1/2 in. (38 mm); with optional tips 8 in. (203 mm)
- Heats 44,000 btu/hr. using 30 cfh acetylene; with optional tips 1 in. (25.4 mm) using 70 cfh acetylene
- Welds 1/4 in. (6.4 mm) using 15 cfh acetylene with optional tips 294,000 btu/hr. using 200 cfh acetylene
- Do-it-all outfit with all components needed for cutting, heating, and welding
- Elite Series combo torch and regulators
- Regulator Burnout Protection (RBO)
- Universal swirl injector for flexibility



Contents

CA-4200 cutting attachment	0558010614
WH-4200 welding handle	0558010617
R-720 acetylene (15-510) regulator	0558010648
R-720 oxygen (125-540) regulator	0558010651
#30 Rosebud Jr. heating head, acetylene	0558006160
4202, 1-1/2 in. (38 mm) cutting tip, acetylene	16K10
#9 welding head, acetylene	639442
#15 welding head, acetylene	639443
Hose	22556
Striker	790F34
Goggles	17862

Ordering Information

Metal Master III 0558011392

Gas Apparatus

Torches

Product Offering Guide



Combination

Extra Heavy-Duty

OXWELD W-17 welding handle
OXWELD CW-23 cutting attachment



WH-17/CW-23

Medium/Heavy-Duty

PUROX Elite Series WH-4200 welding handle
PUROX Elite Series CA-4200 cutting attachment



WH/CA-4200

Mechanized

Extra Heavy-Duty

C-39 mixer torch
C-58 mixer track torch
C-67 injector torch



C-67

C-69, 70 valveless torches
CM-79 track machine

For Steel Industry torches, see Steel Industry Products Section.

Straight Cutting

Extra Heavy-Duty

OXWELD C-66 torch



C-66

OXWELD C-32 torch



C-32

OXWELD SCT-1500 torch



SCT-1500 Trigger BF

Medium/Heavy-Duty

PUROX SCT-4200



SCT-4200 Lever BF

Combination Torches



Elite Swirl Injector¹

Performance Benefits

- In the higher pressure oxygen stream, the injector swirls the oxygen to create a superior homogenous mix of gas in the entrainment zone that increases efficiency
- The superior homogenous mix in the entrainment zone delivers optimum performance not possible with equal pressure mixers and tip mixers
- Swirling of the high-pressure oxygen mixing with the fuel gas creates a pumping action that pulls a vacuum on the torch to improve performance with long hoses and low-pressure operations

¹This feature is available on the new CA-4200 cutting attachment, SCT-1500, and SCT-4200 straight cutting torches.

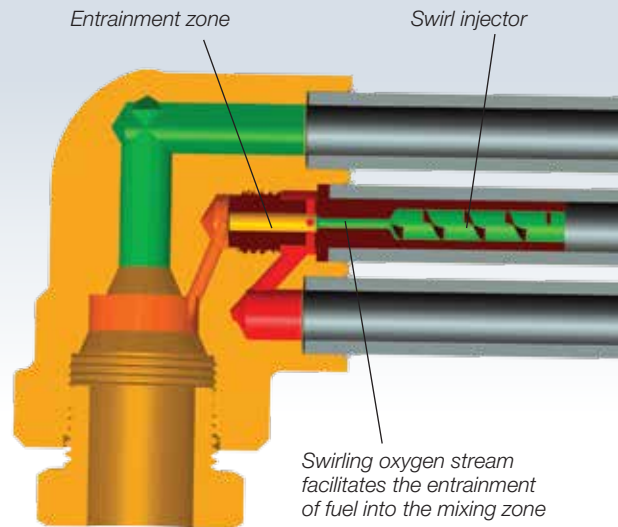

Separate Flash Arrestors

- When flash arrestors are in proper working condition, used per instructions, and checked regularly for clogging, they are excellent safety devices to help prevent injury and flashback
- However, when used incorrectly, flash arrestors can actually cause flashback
- ESAB offers separate flash arrestors that are not built into the torch
- The flash arrestor can be safely checked without causing torch downtime



Torch mounted

Regulator mounted

Gas Apparatus

OXWELD® W-17/CW-23 Combination Torch



Extra Heavy-Duty

- W-17 welding handle
- CW-23 cutting attachment
- Use with any fuel gas
- Cuts 8 in. (203 mm) acetylene
- Cuts 4 in. (102 mm) alternate fuels
- Heats 368,000 btu/hr. using 250 cfh acetylene
- Welds 1 in. (25 mm) using 100 cfh acetylene
- Industry's preferred welding torch
- Universal injector
- Operates on low or medium pressure fuel gas
- Ease-on control of cutting oxygen

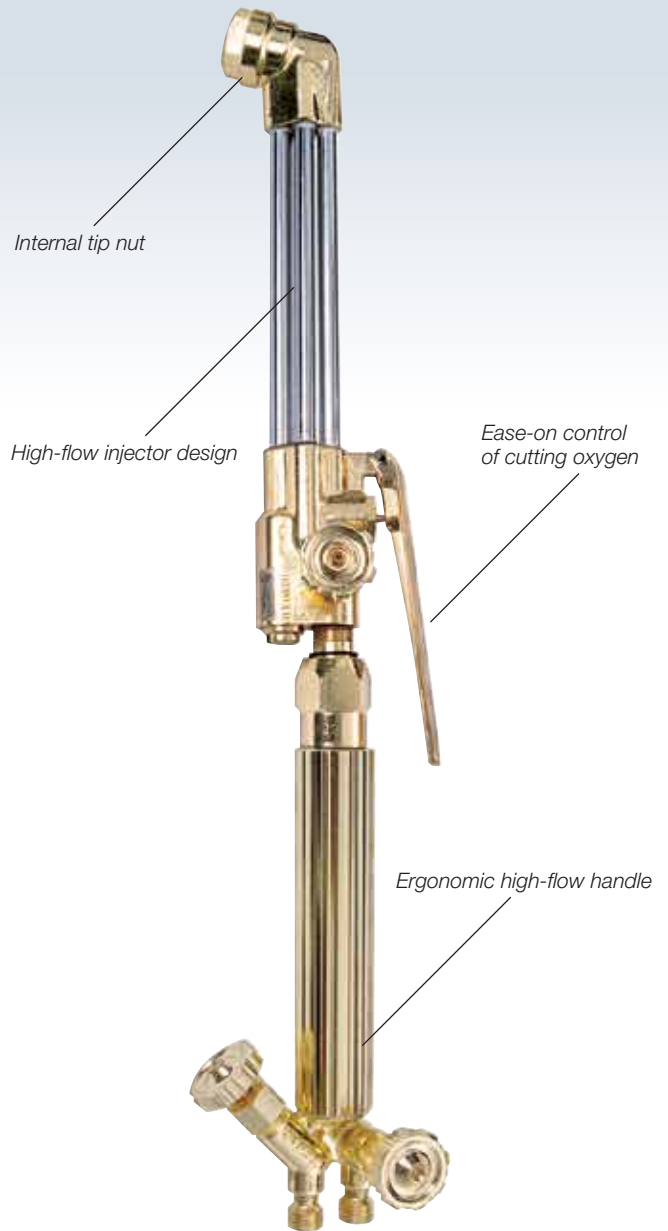



OXWELD® W-17/CW-23 Combination Torch



Extra Heavy-Duty



Cutting Attachment

CW-23	Part Number
90°	01X36
75°	01X35
90° Alternate Fuels	998258

OXWELD Cutting Tip Series

Acetylene
1502
1564

Alternate Fuels
One-Piece 1515
Two-Piece 1567
Specialty



Welding Head, Single flame

Size	Steel Thickness		Part Number
	in.	mm	
4A	1/16	1.6	639865
6A	3/32	2.4	639866
9A	1/8	3.2	639867
12A	3/16	4.8	17270
15A	1/4	6.4	639868
30A	1/2	12.7	639869
70A	1	25.4	998102
100A	Heating		10X03

Flash Arrestors, Torch Pair

Part Number 20357

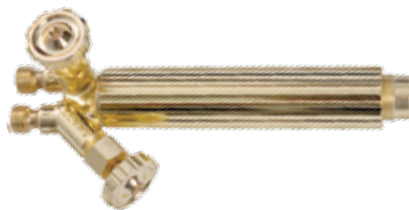

Welding Handle

Description	Part Number
W-17	4250



Heating Head, Multi-flame

Size	Acetylene btu/hr.	Part Number
100A	147,000	11X22
150A	221,000	11X24
250A	368,000	11X26

Alternate Fuels'		Part Number
Size	btu/hr.	
250FG	368,000	11X36



Heating Head, Rosebud

Size	Acetylene btu/hr.	Part Number
55	81,000	998819
100	147,000	998821

Alternate Fuels'		Part Number
Size	btu/hr.	
200	221,000	999234

To find accurate cfm for alternate fuel heating heads, divide the btu/hr. by the figure below for the corresponding gas:

- Propylene 2371
- MAPP 2406
- Propane 2563
- Natural Gas 900-1000

Gas Apparatus

PUROX® Elite Series WH-4200/CA-4200 Combination Torch



Medium/Heavy-Duty

- WH-4200 welding handle
- CA-4200 cutting attachment
- Cuts 8 in. (203 mm) acetylene and alternate fuels
- Heats 294,000 btu/hr. using 200 cfh acetylene
- Welds 1 in. (25 mm) using 70 cfh acetylene
- Most capacity of any medium-duty combo torch on the market
- Properly weighted for reduced fatigue
- Backwards compatible with W-300/CW-300, and W-400
- Patented Universal Head Swirl Injector gas mixing design
- Superior mix of preheat gases
- Improved performance when using long and/or small diameter hoses and low inlet pressure fuel gases due to the vacuum entrainment zone
- Helps resist flashbacks due to this low pressure vacuum effect
- 3-tube, in-line design for increased flow, performance, and durability
- Universal gas design for superior flexibility:
 - Can use any fuel gas including acetylene
 - Just change tip to switch between positive pressure (acet) to injector style (alt fuel) - no need for separate torches
- Ease-on control of cutting oxygen stream reduces spatter when piercing and increases operator confidence
- Color-coded preheat valve knobs for easy adjustments, even with eye shade on
- Internal cutting tip nut design for best tip-to-head seat possible

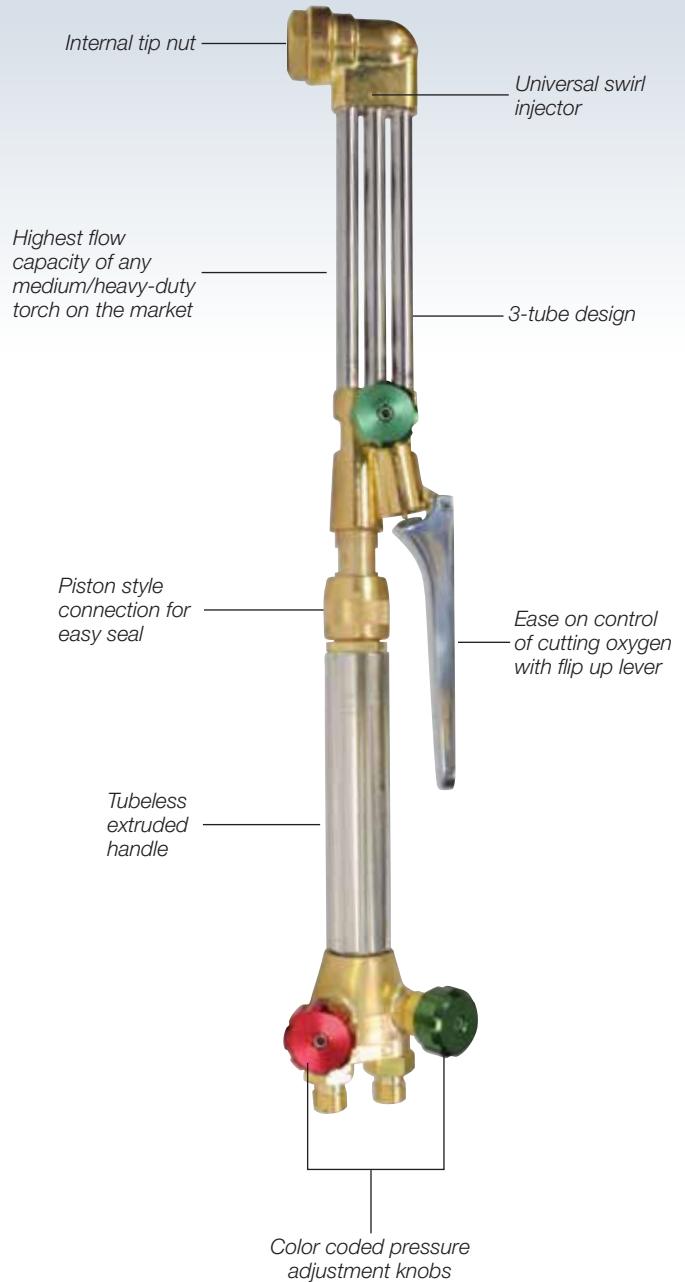



PUROX® Elite Series WH-4200/CA-4200 Combination Torch



Medium/Heavy-Duty



Cutting Attachment

CA-4200	Part Number
90°	0558010614

PUROX Cutting Tips Series

Acetylene
4202
Specialty

Alternate Fuels
One-Piece 4203
One-Piece 4216
Two-Piece 4217
Specialty



Welding Head, Single Flame

Size	Steel Thickness		Part Number
	in.	mm	
1A	Up to 32 gauge		639438
2A	25-32 gauge		639439
4A	1/32	0.8	639440
6A	1/16	1.6	639441
9A	1/8	3.2	639442
12A	3/16	4.8	17268
15A	1/4	6.4	639443
30A	3/8	9.5	17263
55A	5/8	16.0	998085
70A	1	25.4	998086

Flash Arrestors, Torch Pair
Part Number 20357



Welding Handle

Description	Part Number
WH-4200	0558010617



Heating Head, Multi-Flame

Size	Acetylene		Part Number
	btu/hr.		
55A	81,000		998089
70A	103,000		998090
100A	147,000		998091
150A	221,000		998092

Alternate Fuels'		Part Number
Size	btu/hr.	
70FG	103,000	998093



Heating Head, Rosebud

Size	Acetylene		Part Number
	btu/hr.		
15	22,000		998773
30	44,000		998774
30 Jr	44,000		0558006160
55	81,000		998775
70	103,000		998776
100	147,000		998777
200	294,000		998778

Alternate Fuels'		Part Number
Size	btu/hr.	
70	104,000	999225
100	147,000	999228
200	294,000	999231

*To find accurate cfh for alternate fuel heating heads, divide the btu/hr. by the figure below for the corresponding gas:

- Propylene 2371
- MAPP 2406
- Propane 2563
- Natural Gas 900-1000

Gas Apparatus

OXWELD® C-66 with Universal Injector

Straight Cutting Torch



Extra Heavy-Duty

- Any fuel gas
- Cuts 12 in. (305 mm) acetylene
- Cuts 16 in. (406 mm) alternate fuels
- One single universal injector for all fuel gases
- No need to swap injectors
- Ease on control of cutting oxygen
- Same proven design as used in previous C-97 torch
- Internal tip nut design

Ordering Information

21 in. (533 mm), 90°	27X71
21 in. (533 mm), 75°	27X70
26 in. (660 mm), 90°	27X75
26 in. (660 mm), 75°	27X74
36 in. (914 mm), 90°	22139
36 in. (914 mm), 180°	22140
48 in. (1219 mm), 90°	27X87
48 in. (1219 mm), 75°	27X86
48 in. (1219 mm), 180°	27X88

Extra length torches available upon request.



Gas Apparatus

Flash Arrestors, Torch Pair
Part Number 20357



OXWELD Cutting Tips Series

Acetylene
1502
1564
Specialty

Alternate Fuels
One-Piece 1515
Two-Piece 1567
Specialty

Heating Nozzle, Rosebud

Description
All fuel gases

OXWELD® C-32 with Universal Mixer Straight Cutting Torch



Extra Heavy-Duty

- Any fuel gas
- Cuts 12 in. (305 mm) acetylene
- Cuts 3 in. (76 mm) alternate fuels
- One single universal mixer for all fuel gases
- Ease on control of cutting oxygen
- Heavy wall, nickel silver tubes
- Internal tip nut design

Ordering Information

21 in. (533 mm), 90°	01X26
21 in. (533 mm), 75°	01X23
32 in. (813 mm), 90°	27X40
32 in. (813 mm), 180°	27X11
48 in. (1219 mm), 90°	27X41
48 in. (1219 mm), 180°	27X12

Extra length torches available upon request.



Gas Apparatus

Flash Arrestors, Torch Pair
Part Number 20357



OXWELD Cutting Tips Series

Acetylene
1502
1564
Specialty

Alternate Fuels
One-Piece 1515
Two-Piece 1567
Specialty

Heating Nozzle, Rosebud

Description
All fuel gases

OXWELD® SCT-1500 & PUROX® SCT-4200

Elite Series "BF" Straight Cutting Torches



- Can use any fuel gas including acetylene
- Up to 50% more capacity than competitive torches
 - Cuts up to 10 in. (254 mm) with acetylene
 - Cuts up to 12 in. (305 mm) with alternate fuels
- Bottom front cutting oxygen lever/trigger mount position
- Available in multiple versions:
 - OXWELD SCT-1500 Trigger
 - PUROX SCT-4200 Trigger or Lever
- Patented Universal Head Swirl Injector gas mixing design
- Superior mix of preheat gases
- Improved performance when using long and/or small diameter hoses and low inlet pressure fuel gases due to the vacuum entrainment zone
- Helps resist flashbacks due to this low pressure vacuum effect
- 3-tube, in-line design for increased flow, performance, and durability
- Universal gas design for superior flexibility:
 - Just change tip to switch between positive pressure (acet) to injector style (alt fuel) - no need for separate torches
- Ease-on control of cutting oxygen stream reduces spatter when piercing and increases operator confidence
- Color-coded preheat valve knobs for easy adjustments, even with eye shade on
- Internal cutting tip nut design for best tip-to-head seat possible



OXWELD SCT-1500 Trigger BF
PUROX SCT-4200 Trigger BF

PUROX SCT-4200 Lever BF

Ordering Information

OXWELD SCT-1500

90°, bottom front trigger, 21 in. (533 mm) 0558011950
75°, bottom front trigger, 21 in. (533 mm) 0558011949

Uses OXWELD 1500 series cutting tips. Replaces C-77 torch.

PUROX SCT-4200

90°, bottom front trigger, 21 in. (533 mm) 0558011667
75°, bottom front trigger, 21 in. (533 mm) 0558011668
90°, bottom front lever, 21 in. (533 mm) 0558011669
75°, bottom front lever, 21 in. (533 mm) 0558011670

Uses PUROX 4200 series cutting tips. Replaces "E" torch.
Call for extra torch lengths.

PUROX Cutting Tips Series

Acetylene	Alternate Fuels
4202	One-Piece 4203
Specialty	One-Piece 4216
	Two-Piece 4217

OXWELD Cutting Tips Series

Acetylene	Alternate Fuels
1502	One-Piece 1515
1564	Two-Piece 1567
Specialty	Specialty



Flash Arrestors, Torch Pair
Part Number 20357

Machine Cutting Torches



OXWELD® C-67 Machine Cutting Torch

C-67 Injector Legend

Type I

- Less than 5 psi of alternate fuel inlet pressure
- Up to 8 in. (203 mm) cutting capacity
- Excellent multi-torch balancing
- Limited preheat intensity
- L.L.P.M.C. (low, low pressure - medium capacity)

Part Number 01Y61 (20-1/2 in. torch).

Type II

- 3 psi or more of alternate fuel inlet pressure
- Up to 20 in. (508 mm) cutting capacity
- Not recommended for multi-torch balancing
- Great for heavy preheat applications (beveling, aux. preheat, etc.)
- L.P.H.C. (low pressure - high capacity)

Part Number 01Y57 (20-1/2 in. torch).
Part Number 01Y75 (12-3/4 in. torch).

Type III

- 5 psi or more of alternate fuel inlet pressure
- Up to 14 in. (356 mm) cutting capacity
- Best all-around choice for multi-torch operation
- Heavy preheat for quick pierce starts
- L.P.M.C. (low pressure - medium capacity)

Part Number 01Y56 (20-1/2 in. torch).
Part Number 01Y74 (12-3/4 in. torch).

Type IV

- 5 psi or more of alternate fuel inlet pressure
- 12-20 in. (305-508 mm) cutting capacity
- Very heavy preheat and cutting applications
- Up to 28 in. (711 mm) capacity when used with 1400 series SIP torches
- M.P.H.C. (medium pressure - high capacity)

Part Number 01Y58 (20-1/2 in. torch).



Gas Apparatus

Specifications

C-67 Machine Cutting Torch	
Cutting range, alternate fuels	Injector determines
Cutting tips	1500 series
Torch type	Injector
Hose connections	3
Length, in. (mm)	20-1/2 (570) 12-3/4 (324)
Barrel diameter	1-3/8 (35)

Description	Part Number
C-67-20 Type I	28X31
C-67-20 Type II	28X28
C-67-12 Type II	28X35
C-67-20 Type III	28X29
C-67-20 Type IV	28X22

Machine Cutting Torches



OXWELD® C-39 Machine Cutting Torch

■ For use with shape cutting machines

Specifications

C-39 Machine Cutting Torch	
Cutting range, in. (mm):	
Acetylene	18 (457)
Alternate fuels	6 (152)
Cutting tips	1500 series
Torch type	Mixer
Hose connections	3
Length, in. (mm)	20-1/2 (570)
Barrel diameter, in. (mm)	1-3/8 (35)

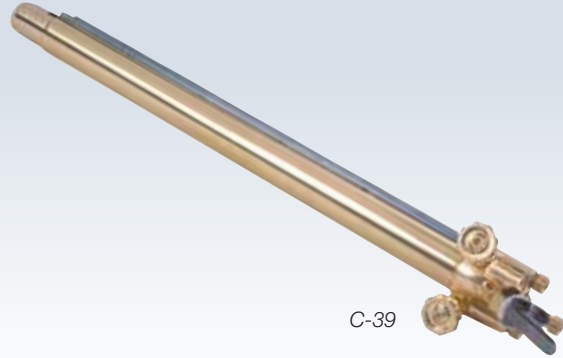

C-39

Ordering Information

C-39 machine cutting torch 01X17

C-58 Machine Cutting Torch

■ For use with straight line or shape cutting machines

Specifications

C-58 Machine Cutting Torch	
Cutting range, in. (mm):	
Acetylene	6 (152.4)
Alternate fuels	2 (50.8)
Cutting tips	1500 series
Torch type	Mixer
Hose connections	2 or 3
Length, in. (mm)	12-1/2 (318)
Barrel diameter, in. (mm)	1-3/8 (35)



C-58

Ordering Information

C-58, 2-hose connection 02X74
 C-58, 3-hose connection 02X44

C-69/70 Machine Cutting Torch

■ Valveless operation for bevel cutting and plate edge preparation

Specifications

C-69/70 Machine Cutting Torch	
Cutting range, in. (mm):	
C-70 acetylene	8 (203)
C-69 alternate fuels	8 (203)
Cutting tips	1500 series
Torch type	Injector
Hose connections	3
Length, in. (mm)	6 (152.4)
Barrel diameter, in. (mm)	1-1/4 (32)



C-69

Ordering Information

C-69 without rack 28X47
 C-70 without rack 28X53

CM-79 Portable Cutting Machine



- Solid state controls for dependable, maintenance-free service
- Three position switch for start, stop, and reverse
- Clutch levers at both ends of carriage for greater accessibility
- Direct reading speed control dial - can be preset or instantly adjusted during operation
- Normal speed range 0-60 ipm (0-1.5 m/min)
- Easily adjustable to 90 ipm (2.3 m/min)
- Sturdy one-piece aluminum housing
- Heavy-duty motor with built-in solid state governor for dependable, accurate speed

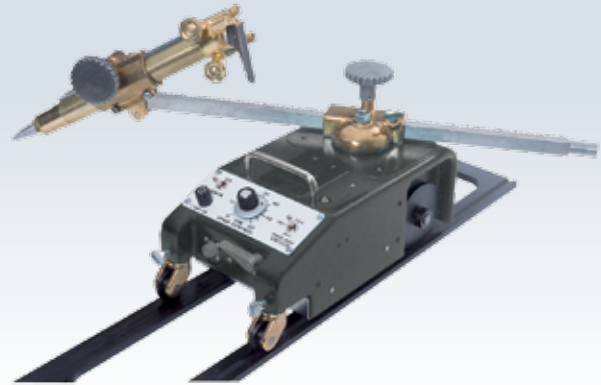

CM-79 with C-58 torch, rigging assembly, and track

Ordering Information

Machine or Rigging Only

CM-79 portable machine carriage, 28 ft. (8.5 m) lead . 995557
 Torch rigging assembly 16V90

Basic machine package 998695

Includes: standard machine, rigging, and manifold kit.

Complete Machine Package

Includes: everything supplied with Basic Package plus C-58 torch #02X74.

Heat shield and heavy-duty track section 998947

Options & Accessories

Heavy-Duty Track Section

6 ft. (2 m) 16V82
 7-1/2 ft. (2.3 m)..... 20086
 9 ft. (2.7 m) 2223156

Circle cutting attachment, 2-54 in. (41-1372 mm) diameter . 16V84
 Double heat shield kit 995586
 Counterweight¹ 995587
 Manifold kit 639659
 High temperature kit² 997608

¹For balancing heavy, off-center equipment loads.
²Recommended when carriage must travel on hot plates;
 temperature of control unit should not exceed 70°C (158°F).
 Contact your ESAB supplier for additional information.

Gas Apparatus

Specifications

Overall Size			Weight	Carrying Load Maximum	Speed Range	Cutting Capacity	Circle Cutting Range	Power Requirements
Length	Height	Width						
in. (mm)	in. (mm)	in. (mm)	lbs. (kg)	lbs. (kg)	ipm (m/min)	in. (mm)	in. (mm)	
15-1/4 (387)	7 -(178) (including mounting stud)	7 1/4 (184)	21 (9.5) (without rigging or torch)	250 (113)	0-60 ¹ (0-1.5)	0-4 (102) thick ²	2-54 ³ (51-1371)	120 vac, 2 amp (maximum), 50/60 Hz, 1 ph

¹Can be adjusted to attain speeds up to 90 ipm (2.3 m/min).
²Up to 10 in. (254 mm) with accessory heat shield.
³Can be increased by use of longer rod easily made from standard bar stock.

Pressure Drops in Hose

To operate oxy-acetylene welding and cutting torches with maximum efficiency, certain inlet pressures must be maintained at the torch. Pressure at the torch may be determined by placing a gauge adaptor assembly between the hose connections on the torch and on the hose. When no adaptor is available, the regulators should be set to values somewhat above those recommended for the torch in order to compensate for the pressure drop in the hose.

Pressure drop data for the most commonly used sizes and lengths of oxygen and acetylene hoses appears in the following tables. By adding the pressure drop for the specific piece of hose to the desired torch pressure, the pressure actually required at the regulator can be determined. Values falling between those shown in the tables can be easily determined by interpolation.

Pressure Drop in Oxygen Hose

Delivery Pressure lbs./in ²	Oxygen Flow cfh	3/16 in. Hose Length				1/4 in. Hose Length				5/16 in. Hose Length				3/8 in. Hose Length			
		12-1/2 ft.	25 ft.	50 ft.	100 ft.	12-1/2 ft.	25 ft.	50 ft.	100 ft.	12-1/2 ft.	25 ft.	50 ft.	100 ft.	12-1/2 ft.	25 ft.	50 ft.	100 ft.
5	100	5.8	7.8	11.6	19.2	2.3	2.6	4.7	7.4	**	**	**	2.7	**	**	**	2.3
	250	20.7	26.8	38.1	54.3	11.7	13.8	20.0	28.2	3.4	4.9	6.6	11.5	**	2.8	4.1	7.5
	500	52.5	63.1	-	-	33.7	37.5	50.0	68.5	20.1	25.7	34.5	-	5.8	8.7	12.3	19.7
	750	-	-	-	-	-	-	-	-	28.9	-	-	-	12.7	16.2	23.2	35.4
	1,000	-	-	-	-	-	-	-	-	-	-	-	-	20.2	25.9	36.1	-
1,500	-	-	-	-	-	-	-	-	-	-	-	-	35.5	47.2	-	-	
10	100	5.0	6.3	10.8	18.8	**	2.0	3.8	6.0	**	**	**	2.3	**	**	**	2.0
	250	18.3	24.8	35.4	53.0	9.4	11.8	17.2	25.0	2.7	4.1	5.9	10.0	**	**	3.3	6.4
	500	47.8	58.5	-	-	30.1	34.4	46.8	63.9	9.3	12.9	17.2	26.6	4.7	6.2	11.0	17.7
	750	-	-	-	-	-	-	-	-	18.6	25.0	31.9	44.1	9.6	13.4	21.2	33.1
	1,000	-	-	-	-	-	-	-	-	27.9	37.3	47.3	-	16.2	22.8	33.2	-
1,500	-	-	-	-	-	-	-	-	47.0	-	-	-	31.0	43.4	-	-	
25	100	3.6	5.7	8.2	13.4	**	**	2.9	4.3	**	**	**	**	**	**	**	**
	250	13.2	18.3	28.0	41.5	6.3	7.9	11.7	16.8	**	2.4	3.2	6.7	**	**	**	3.7
	500	37.5	48.4	67.8	-	21.5	25.6	35.8	51.2	6.3	8.7	12.1	19.9	2.7	4.6	6.9	11.9
	750	-	-	-	-	42.0	49.3	-	-	12.2	17.0	22.4	33.9	6.1	10.2	15.0	23.9
	1,000	-	-	-	-	-	-	-	-	20.6	27.5	32.5	48.0	10.7	15.6	24.9	38.6
	1,500	-	-	-	-	-	-	-	-	38.2	52.4	-	-	21.4	32.3	49.5	-
2,000	-	-	-	-	-	-	-	-	56.3	-	-	-	34.4	-	-	-	
50	100	2.0	3.4	5.9	9.3	**	**	2.0	2.7	**	**	**	**	**	**	**	**
	250	8.0	12.6	19.4	29.4	2.7	5.0	7.9	11.0	**	**	2.2	3.9	**	**	**	2.6
	500	25.6	30.4	52.8	77.8	14.1	18.2	25.8	35.0	3.4	5.9	7.7	13.3	**	2.9	4.7	8.0
	750	48.0	64.7	-	-	29.0	36.9	50.7	68.6	8.8	12.3	17.8	27.0	3.8	6.0	9.8	10.9
	1,000	73.7	-	-	-	48.4	69.8	-	-	15.2	22.1	35.5	42.1	6.8	10.5	16.8	28.1
	1,500	-	-	-	-	95.4	-	-	-	28.4	58.3	-	-	15.0	22.7	35.1	54.7
	2,000	-	-	-	-	-	-	-	-	45.1	-	-	-	25.6	31.0	56.1	-
3,000	-	-	-	-	-	-	-	-	-	-	-	-	51.1	70.5	-	-	
75	100	**	2.6	3.8	7.1	**	**	**	2.2	**	**	**	**	**	**	**	**
	250	6.0	3.4	13.3	23.1	3.0	3.8	6.0	8.2	**	**	**	2.8	**	**	**	2.0
	500	19.7	27.8	42.4	65.5	10.7	13.8	19.8	27.2	2.5	3.9	6.3	9.4	**	2.0	3.4	5.9
	750	38.2	52.2	73.6	-	22.5	28.3	40.5	55.0	6.6	8.8	13.7	18.8	2.7	4.1	7.0	12.2
	1,000	59.7	-	-	-	38.6	47.3	66.1	-	11.8	14.7	22.6	31.0	4.9	6.9	12.0	20.3
	1,500	-	-	-	-	82.5	96.5	-	-	25.8	31.4	40.2	51.2	11.3	15.7	25.7	41.8
	2,000	-	-	-	-	-	-	-	-	47.1	53.9	-	-	18.7	22.4	43.0	67.6
3,000	-	-	-	-	-	-	-	-	-	-	-	-	40.3	55.0	87.3	-	
100	100	**	**	2.7	4.6	**	**	**	**	**	**	**	**	**	**	**	**
	250	4.7	6.7	10.3	16.9	2.2	2.8	4.3	6.0	**	**	**	2.2	**	**	**	**
	500	14.1	21.0	31.6	48.0	8.1	10.8	15.0	21.2	2.0	2.9	4.4	7.1	**	**	2.1	4.6
	750	29.0	42.0	59.5	75.0	17.7	23.0	32.3	42.8	4.7	6.9	10.3	15.4	**	2.9	4.9	8.7
	1,000	48.0	67.5	-	-	31.0	37.0	53.0	68.5	8.6	11.8	17.4	25.0	3.1	5.2	8.8	14.4
	1,500	98.0	-	-	-	65.5	82.0	-	-	19.1	25.5	32.4	47.0	7.7	11.8	19.4	32.1
	2,000	-	-	-	-	-	-	-	-	32.8	42.2	47.0	70.0	13.4	15.2	32.1	53.4
3,000	-	-	-	-	-	-	-	-	67.2	83.3	-	-	30.9	41.5	67.4	-	

*The values listed in table are average for new hose including standard fittings as listed. **Indicates pressure drop of less than 2.0 lb. per sq. in.

Hose Nipples	3/16 in. Hose	1/4 in. Hose	5/16 in. Hose	3/8 in. Hose
Hole Diameter	0.125	0.1405	0.1935	0.250

Variations of plus or minus 10% may be expected, depending largely upon condition of the hose and fittings. To obtain inlet pressure, add the delivery pressure to the pressure drop given in the table.

Pressure Drops in Hose



Pressure Drop in Acetylene Hose

Delivery Pressure lbs./in ²	Acetylene Flow cfh	3/16 in. Hose Length				*1/4 in. Hose Length				*5/16 in. Hose Length				*3/8 in. Hose Length			
		12-1/2 ft.	25 ft.	50 ft.	100 ft.	12-1/2 ft.	25 ft.	50 ft.	100 ft.	12-1/2 ft.	25 ft.	50 ft.	100 ft.	12-1/2 ft.	25 ft.	50 ft.	100 ft.
2	25	0.3	0.5	1.0	1.8	**	**	0.5	0.8	**	**	**	0.3	**	**	**	2.3
	50	1.2	2.3	3.2	5.7	0.5	0.9	1.3	2.4	**	0.3	0.4	0.7	**	**	0.3	0.4
	75	2.6	3.9	6.6	-	1.2	1.8	2.5	4.5	0.4	0.5	0.8	1.4	**	0.3	0.5	0.8
	100	4.3	6.6	-	-	1.8	2.8	4.4	7.2	0.5	0.8	1.3	2.4	0.3	0.4	0.7	1.1
	150	8.4	-	-	-	4.0	5.7	8.9	-	1.2	1.7	2.7	4.8	0.5	0.8	1.2	2.2
	250	-	-	-	-	9.2	-	-	-	2.9	4.3	5.8	10.4	1.2	1.8	2.9	5.4
	500	-	-	-	-	-	-	-	-	10.3	13.2	-	-	4.1	6.0	9.0	-
	750	-	-	-	-	-	-	-	-	-	-	-	-	8.2	-	-	-
1,000	-	-	-	-	-	-	-	-	-	-	-	-	-	-	-	-	
5	25	0.4	0.7	1.1	2.1	**	0.3	0.6	1.0	**	**	**	**	**	**	**	**
	50	1.3	2.2	3.8	6.8	0.6	1.0	1.6	2.8	0.3	0.3	0.5	0.8	**	**	0.3	0.5
	75	2.7	4.3	7.3	-	2.2	3.3	5.0	-	0.5	0.6	0.9	1.6	**	0.3	0.5	0.8
	100	4.6	7.5	-	-	4.5	6.5	-	-	0.6	1.0	1.5	2.8	0.3	0.5	0.8	1.3
	150	9.6	-	-	-	11.1	-	-	-	1.3	2.0	3.2	5.3	0.6	0.8	1.4	2.5
	250	-	-	-	-	-	-	-	-	3.3	5.0	7.1	11.5	1.4	2.1	3.4	6.0
	500	-	-	-	-	-	-	-	-	11.0	15.2	-	-	4.6	6.7	11.1	-
	750	-	-	-	-	-	-	-	-	-	-	-	-	9.1	-	-	-
1,000	-	-	-	-	-	-	-	-	-	-	-	-	-	-	-	-	
7	25	0.3	0.5	0.9	1.6	**	**	0.4	0.7	**	**	**	**	**	**	**	2.3
	50	1.1	1.8	3.0	5.4	0.5	0.8	1.2	2.1	**	0.3	0.3	0.7	**	**	0.3	0.4
	75	2.2	3.6	6.0	-	1.0	1.5	2.4	4.2	0.3	0.4	0.6	1.4	**	**	0.4	0.7
	100	3.8	6.2	-	-	1.7	2.5	4.0	6.8	0.5	0.7	1.0	2.3	0.3	0.4	0.6	1.0
	150	8.2	-	-	-	3.6	5.2	8.0	-	1.0	1.6	2.3	4.5	0.5	0.7	1.1	2.1
	250	-	-	-	-	9.2	-	-	-	2.4	3.9	5.7	9.8	1.0	1.6	2.7	5.1
	500	-	-	-	-	-	-	-	-	9.1	12.4	-	-	3.7	5.5	9.2	-
	750	-	-	-	-	-	-	-	-	-	-	-	-	7.7	-	-	-
1,000	-	-	-	-	-	-	-	-	-	-	-	-	-	-	-	-	
10	25	0.3	0.5	0.8	1.4	**	**	0.3	0.7	**	**	**	**	**	**	**	**
	50	0.9	1.6	2.5	4.9	0.5	0.7	1.1	2.0	**	**	0.3	0.6	**	**	**	0.3
	75	2.0	3.1	5.3	10.7	0.9	1.4	2.2	3.7	0.3	0.4	0.5	0.6	**	**	0.3	0.6
	100	3.3	5.4	-	-	1.6	2.2	3.6	6.0	0.4	0.6	0.9	1.2	**	0.3	0.5	0.9
	150	7.0	-	-	-	3.2	4.5	7.3	-	0.9	1.3	2.1	3.9	0.4	0.8	1.0	1.9
	250	-	-	-	-	8.1	-	-	-	2.3	3.5	5.2	8.8	6.9	1.4	2.5	4.4
	500	-	-	-	-	-	-	-	-	8.2	11.5	15.1	-	3.3	4.8	8.3	13.2
	750	-	-	-	-	-	-	-	-	-	-	-	-	7.0	13.2	-	-
1,000	-	-	-	-	-	-	-	-	-	-	-	-	-	-	-	-	
13	25	**	0.4	0.7	1.3	**	**	0.3	0.6	**	**	**	**	**	**	**	**
	50	0.8	1.4	2.4	4.8	0.4	0.6	0.9	1.6	**	**	**	0.4	**	**	**	0.4
	75	1.9	2.9	5.0	10.0	0.8	1.2	1.9	3.0	**	0.3	0.5	1.0	**	**	0.3	0.5
	100	3.5	5.1	-	-	1.4	2.0	3.0	4.7	0.3	0.6	0.7	1.7	**	0.3	0.4	0.8
	150	7.9	-	-	-	2.9	4.0	6.0	8.7	0.8	1.2	1.7	3.4	0.3	0.5	0.9	1.8
	250	-	-	-	-	7.4	9.5	-	-	2.0	3.1	4.5	8.1	0.7	1.2	2.3	3.8
	500	-	-	-	-	-	-	-	-	8.7	10.5	13.7	-	2.9	4.0	8.1	11.5
	750	-	-	-	-	-	-	-	-	-	-	-	-	6.6	8.1	-	-
1,000	-	-	-	-	-	-	-	-	-	-	-	-	-	-	-	-	

*The values listed in table are average for new hose including standard fittings as listed. **Indicates pressure drop of less than 0.3 lb. per sq in.

Hose Nipples	3/16 in. Hose	1/4 in. Hose	5/16 in. Hose	3/8 in. Hose
Hole Diameter	0.126	0.1405	0.1935	0.250

Variations of plus or minus 10% may be expected, depending largely upon condition of the hose and fittings. To obtain inlet pressure, add the delivery pressure to the pressure drop given in the table.

Gas Apparatus

Flash Arrestors, Check Valves & Supplies

Hose Line Flash Arrestors

- Will actually stop a flashback when properly operated when attached to OXWELD® or PUROX® Elite Series torch handles with “B” size inlets
- Also designed to stop reverse flow of gases; should be left in place when hose is detached

Flow rate maximum

For cutting = up to 12 in. (305 mm) tip.
 For heating or welding = up to a #100 head.



Torch mounted

Regulator mounted

Ordering Information - Flash Arrestors

Torch Mounted

Matched pair	20357
Oxygen	20373
Acetylene	20374

Regulator Mounted

Matched pair	0558002695
Oxygen	0558002693
Fuel gas	0558002694

Reverse Flow Check Valves

- Attached either to a torch or a regulator, they provide a certain measure of protection against reverse flow of gases
- Any condition that might cause reverse flow will close the valve completely
- Reverse flow check valves should be tested periodically for reverse flow leakage - frequency of testing depends on severity of service

CAUTION:

Check valves ARE NOT designed to stop a flashback.

Flow rate maximum

100 cfh using check valves.



Check Valves

Ordering Information - Check Valves

For attachment to “B” size torch inlets

Oxygen	639110
Fuel gas	639109

For replacement of 1/4 in. (6.4 mm) NPT to “B” size regulator outlet connection

Oxygen	639112
Fuel gas	639111

For attachment to “B” size regulator outlets

Oxygen	639209
Fuel gas	639210

For attachment to “A” size inlet

Oxygen	6271725
Fuel gas	6271726

ORS Inlet

Oxygen	639212
Fuel gas	639211

ORS = OXWELD Railway Service

Fitted Hose Assemblies

All hoses meet or exceed the standards for welding and cutting hoses established jointly by the Compressed Gas Association and the Rubber Manufacturers Association. They conform to Specification of the Association of American Railroads and to the requirements of the National Fire Protection Association.



Single Line Hose

■ Type S

Consists of one braid or ply of reinforcement; normal welding and cutting service.

Twin Hose

■ Type VD

Consists of two hoses with single braid or ply reinforcement identical in construction - one for oxygen, one for acetylene - connected continuously along the sides. Oxygen is green, acetylene is red. Both covers are smooth.

Maximum Working Pressure

Type S (one braid or ply)200 psig
 Type VD (two braid or ply).....200 psig

Grades of Single & Twin Hose

■ Grade RM

Has neoprene cover which is flame- and oil-resistant and a non-oil-resistant inner rubber tube. For use with oxygen and acetylene only.

■ Grade R

Has a non-oil-resistant rubber inner tube and cover. For use with acetylene only.

■ Grade T

For use with oxygen and all gases.

Fitted Assemblies

Fittings used with single and twin hose assemblies are standard hose connection nuts, nipples, and crimped ferrules.

Single Fitted Hose Assemblies (Type S, Grade R) Acetylene Only

Description	Length	Connection Sizes	Part Number (Acetylene Only)
	ft. (m)		
3/16 in. (4.8 mm) Fitted Hose Assemblies	6 (1.8)	A-A	501F11
	12.5 (3.8)	A-A	501F12
	25 (7.6)	A-A	501F13

Twin Fitted Hose Assembly (Grade T) Oxygen & All Gases

Description	Length	Connection Sizes	Part Number (Acetylene Only)
	ft. (m)		
3/16 in. (4.8 mm) Twin Fitted Hose Assemblies	12.5 (3.8)	A-A	591F72
	25 (7.6)	B-B	593F83

Twin Fitted Hose Assembly (Type VD, Grade RM) Oxygen & Acetylene

Description	Length	Connection Sizes	Part Number	
	ft. (m)			
3/16 in. (4.8 mm) Twin Fitted Hose Assemblies	12.5 (3.8)	A-A	571F72	
		A-B	591F71	
		B-B	572F82	
	25 (7.6)	A-A	571F73	
		A-B	574F93	
		B-B	572F83	
50 (15.2)	B-B	572F84		
	1/4 in. (6.4 mm) Twin Fitted Hose Assemblies	25 (7.6)	B-B	583F83
		50 (15.2)	B-B	583F84
100 (30.5)	B-B	583F85		

Gas Apparatus

Accessories



Adjustable Bevel Cutting Adaptor

For use with machine cutting torches using 1500 Series tips. The adaptor connects to the torch in the same simple manner as a cutting tip. It has an angular adjustment range from 0°-90° on either side of the vertical center line of the torch and locks at the desired angle of bevel by means of a socket head screw. Tip aligns with same center line as torch at any angle.

Auxiliary Preheat Kits for Bevel Cutting

For use with adjustable bevel cutting adaptor. The kit contains the necessary parts for attaching a preheat head (included in the kit) to the adaptor. The head leads the cutting tip and furnishes additional preheat for the cutting operation. The bend in the head may be readily modified, as desired. Auxiliary preheat kits are available for use with both acetylene and natural gas.

Ordering Information

Adjustable bevel cutting adaptor 18845

Auxiliary Preheat Kit (for above)

Acetylene 61Y99
Natural gas 63Y13



Slitting Adaptor

This adaptor fits directly on all cutting torches using 1500 Series tips. It has a scissors-type arrangement which gives an adjustment range from 1-1/2 to 12 in. (33 to 305mm) between the center line of the two tips. It is used in operations requiring parallel cuts as in coupon or slot cutting.

Ordering Information

Slitting adaptor - scissors type 22X42



Test Gauge Adaptor

- Easy-to-read 2-1/2 in. (63.5 mm) gauge faces
- Identifies pressure/flow problems
- Easy to install and remove
- Permanent or temporary mounting
- Used to measure gas pressures at torch inlet connections

Ordering Information

Test Gauge Adaptors

For oxygen, 0-100 psig, "B" 07X17
For oxygen, 0-200 psig, "C" 21X48
For acetylene, 0-15 psig, "B" 262510
For alternate fuels, 0-100 psig, "B" 639422



Welding & Heating Head Extensions for WH-4200/W-17

Permit working at a comfortable distance from heat during heavy welding and heating jobs.

Head Size	Length of Extension		Part Number
	in.	mm	
55/70	12	305	19X42
100	15	381	19X43
200	18	457	998790 ¹
250/300	21	533	19X45 ²
500	21	533	998825

¹Requires coupling #998838.
²Requires coupling #998839.

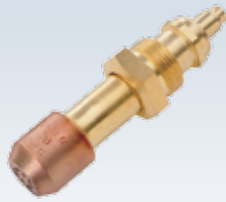

Rosebud Heating Nozzle

- For cutting torches with 1500 series tips
- Quickly converts from cutting to heating

Ordering Information

Rosebud Heating Nozzles

Number 55 acetylene	20238
Number 70 alternate fuels	20234



Two-Way Oxygen Inlet Adaptor

- Permits use of one hose for both preheat and cutting oxygen on torches, which otherwise require two hoses

Ordering Information

Two-way oxygen inlet adaptor	18X20
------------------------------------	-------



Quick-Closing Oxygen Shutoff Valve

Particularly recommended when using Number 200 O-FG or above O-FG Rosebud Heating Heads. Connects between torch and oxygen hose for quickly shutting off oxygen flow in the event of flashback.

Ordering Information

Quick-closing oxygen shutoff valve	999306
------------------------------------------	--------



Torch Cutting Guide/Circle Cutting Attachment

A truly universal torch cutting guide for use with OXWELD, and PUROX Elite Series hand cutting torches and cutting attachments. The guide is supplied with inserts to accept either OXWELD or PUROX tips, and it will accept both series of Victor® tips.

To use the guide as a circle cutting attachment, just remove the guide handle and insert the guide rod and center point (which is supplied as part of the kit). Users can cut circles 5-25 in. (127-635 mm) in diameter.

Ordering Information

Torch cutting guide/circle cutting attachment.	0558002676
------------------------------------------------	------------



Torch Roller Cutting Guide Kit

A truly universal torch cutting guide for use with OXWELD, and PUROX Elite Series hand cutting torches and cutting attachments. The guide is supplied with inserts to accept either OXWELD or PUROX tips, and it will accept both series of Victor tips.

Ordering Information

Torch roller cutting guide kit	0558004121
--------------------------------------	------------

Victor® is a registered trademark of Thermadyne Holdings Corporation.

Accessories



Leak Test Solution

Recommended when testing regulators or torches for leaks.

Ordering Information

8 ounces 998771



Indexable model



Gripper model

OXWELD Soapstone Markers

Indexable Model

A flat soapstone marker in stainless steel indexable holder. Stone can be advanced to new position with one hand. Oversized, sturdy pocket clip.

Gripper Model

Pencil-sized, anodized holder with built-in chuck to position and hold round soapstone element.

Ordering Information

Indexable model soapstone marker (2/pkg)..... 639133

Replacement flat soapstone element (144/pkg)..... 639141

Gripper model soapstone marker (72/pkg) 791F66

OXWELD Tip Cleaners

- For cleaning orifices of welding heads and cutting tips
- Stainless steel burnishers
- Sets are hinged in aluminum cases
- Choice of five sets - each includes cleaning file
- King size cleaner (4-1/8 in. long) can clean tip from back end
- Accessory brass bristle spline brush (#750F99) for cleaning internal slots in two-piece tips - stores in tip cleaner case
- Identification stamped on back of each case
- Special set for High Speed "HS" tips

Set	Number of Cleaners	Drill Size Range	Part Number
Standard	12	49-75	751F00
King size	12	49-75	754F00
Jumbo	9	30-48	752F00
Master ¹	21	30-75	753F00
"HS" ²	15	-	755F00

¹Includes all cleaners from both Standard and Jumbo sets.
²For cleaning orifices of 1563 HS and 1566 HS cutting tips.



Tip Cleaner Set

Wrenches

Description	Openings		Part Number
	in.	mm	
Large Combination Wrench - for connecting oxy-fuel torch, hoses, and regulators. Also equipped with socket wrench for acetylene cylinders with CGA-300 valve outlet	7/16	11	791F76
	1/2	13	
	9/16	14	
	5/8	16	
	11/16	17.5	
	7/8	22	
	1	25	
1-1/8	29		



Large Combination Wrench

Friction Lighters

- Single- or triple-flint models
- Specially hardened file surface
1 over 1 sq.in. (25 mm²)
- Fat spark - flint strikes file at angle
- Quick ignition - protection cup forms gas-collection pocket
- File turns automatically - equalizes wear
- Easily replaceable flints
- Individually blister-packed

Description	Part Number
Single flint lighter heavy-duty model box of 10	790F34
Heavy-duty renewal flints box of 200	790F37
Three flint friction lighter	790F35
Three flint renewal unit - card of 4	790F98
Three flint renewal unit - card of 1	790F36



Single Flint Lighter



Three Flint Lighter

Cutting Tips

Product Offering Guide



OXWELD®

Cutting Attachment or Torch	OXWELD Cutting Tip Series
One-Piece Acetylene	
SCT-1500 C-32 C-66 CW-23 C-39 C-58 C-70	1502
One-Piece Alternate Fuels	
SCT-1500 C-32 C-66 CW-23 C-67 C-39 C-58 C-69	1515 1564
Two-Piece Alternate Fuels	
C-67 C-39 C-58 C-69 C-70 SCT-1500 C-32 C-66 CW-23	1566 high speed 1567
Specialty Tips	
	1507 1539 1510 1511 1520 1568 1516
Consult tip page to confirm applicable torch compatibility	

PUROX®

Cutting Attachment or Torch	Cutting Tip Series
One-Piece Acetylene	
SCT-4200 CA-4200	4202
One-Piece Alternate Fuels	
SCT-4200 CA-4200	4203 4216
Two-Piece Alternate Fuels	
SCT-4200 CA-4200	4217
Specialty Tips	
SCT-4200 CA-4200	4206 4207 4209 4218

Victor®

Cutting Attachment or Torch	Victor Style Cutting Tip Series
One-Piece Acetylene	
Any series 1-101 compatible torch	Q1-101
Any series 3-101 compatible torch	Q3-101

Victor® is a registered trademark of Thermadyne Holdings Corporation.

Operating Data - Important Notes

- Operating data is based on typical operating conditions. All values shown are average values. Factors such as the type and quality of the steel, its surface condition, the purity of the oxygen used in the cutting reaction, etc., will directly affect the results obtained.
- All pressures given are measured at the torch. Pressure drop through hose must be considered when setting pressure at the regulator. Generally, 1/4 in. (6.4 mm) I.D. hoses up to 25 ft. (7.6 m) long are adequate for cutting steel up to 4 in. (102 mm). If longer hoses are required, and if cutting thicker steels, 3/8 in. (9.4 mm) I.D. hoses should be used.
- The given data for acetylene tips is based on medium pressure torches. Unless otherwise stated, they will work with low pressure acetylene when higher oxygen pressure may be required, particularly when cutting steel plate 4 in. (102 mm) thick and up.
- Kerf widths in the tables are average. When the kerf widths are of particular importance, a trial cut in scrap section is recommended.
- Given pressures and flows are ranges. Please reference your specific torch literature for the most accurate tip pressures and flows.

Cutting Tips

OXWELD[®], PUROX[®], Victor[®] Style Cutting Tips



- Precise CNC controlled drilling process ensures consistency in performance and quality
- One-piece tips are mirror smooth with internal angles rounded for non-turbulent, more efficient gas flow - clean, smooth cuts with minimal kerf
- Preheat ports are closely spaced around cutting orifice for greater concentration of preheat flames
- Long, parallel preheat passages permit re-dressing tips without affecting performance
- One-piece tips are a single piece of solid copper - provide maximum cooling - recommended always for acetylene, and for other fuel gases when heat exposure is unusually severe
- Two-piece tips - recommended for high efficiency with alternate fuels - solid copper, heavy-wall external sleeve and brass internal sections can be ordered separately to minimize replacement cost



One-Piece Acetylene Cutting Tip

Four Steps to Proper Tip Selection

- 1. Choose One-Piece or Two-Piece Tip:**
Acetylene - one-piece tip always.
Alternate Fuels - two-piece tip provides most efficient operation for normal cutting. One-piece tip extends life where heating is very severe.
- 2. Choose Series:**
See "Cutting Tips Product Offering Guide".
- 3. Choose Preheat Capacity:**
Choice of tip depends on preheat capacity. See description above tip pictures on following pages. Steel-coated with rust and scale, as well as bevel cutting, requires heavy preheat.
- 4. Choose Size:**
Select size recommended for thickness of steel to be cut. Oversize tips waste gas. Use oxygen pressure recommended for tip.

Victor[®] is a registered trademark of Thermadyne Holdings Corporation.

One-Piece Tips

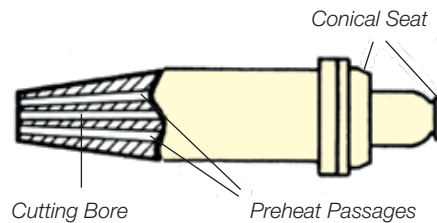

Two-Piece Tips

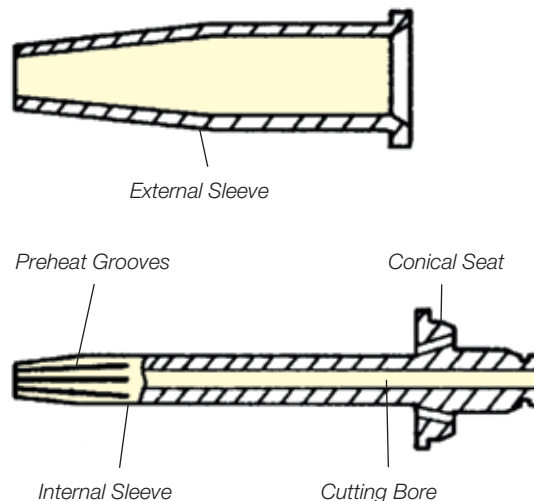

1500 Group Tips

One-Piece Acetylene



1502 Series

Hand or Machine Cutting Tips

Metal Thickness		Tip Size		Part Number	Number Preheat Holes	Cleaning Preheat	Drill Size Cutting	
in.	mm	in.	mm				in.	m
1/4	6	1/4	6	08Z67	6	69	68	1.7
1/2	13	1/2	24	15Z17	6	66	60	1.5
1-1/2	38	1-1/2	38	15Z18	6	65	53	1.3
2-4	50-100	4	102	15Z19	6	61	46	1.2
6-8	150-200	8	203	15Z20	6	57	39	1.0
9-12	230-300	12	305	15Z21	6	56	31	0.8
16-18	400-460	18 ¹	457	13A97	6	54	15	0.4
20	500	20 ²	508	13A98	6	54	8	0.2

- General purpose
- Medium preheat sufficient for cutting dirty plate and for beveling



Operating Data

Metal Thickness		Tip Size		Part Number	Gas Pressure			Cutting Speed		Gas Consumption		Average Kerf Width	
					Cutting Oxygen	Preheat Oxygen	Acetylene			Total Oxygen	Acetylene		
in.	mm	in.	mm	Number	psig	psig	psig	ipm	mm/min	cfh	cfh	in.	mm
1/4	6	1/4	6	08Z67	30-35	20-25	5-7	17-25	432-635	35-45	6-8	.045	1.1
1/2	13	1/2	13	15Z17	35-40	20-25	5-7	15-23	381-584	65-75	8-10	.065	1.7
3/4	19	1-1/2	38	15Z18	35-40	20-25	5-7	13-21	330-533	120-135	14-16	.075	1.9
1	25	1-1/2	38	15Z18	40-45	20-25	5-7	12-18	305-457	130-140	14-16	.080	2.0
1-1/2	38	1-1/2	38	15Z18	40-45	20-25	5-7	11-16	279-406	150-170	16-20	.090	2.3
2	51	4	102	15Z19	40-45	20-25	6-8	10-14	254-356	185-210	16-20	.095	2.4
2-1/2	63.5	4	102	15Z19	40-45	20-30	6-8	9-12	229-305	190-235	16-20	.095	2.4
3	76.1	4	102	15Z19	45-60	20-30	6-8	8-11	203-279	205-255	16-20	.100	2.5
4	102	4	102	15Z19	50-55	25-30	6-8	6-9	152-229	235-285	19-22	.105	2.7
6	152	8	203	15Z20	35-45	25-30	8-10	4.5-6.5	114-165	395-460	20-25	.157	4.0
8	203	8	203	15Z20	55-65	30-35	8-10	3.5-5.0	89-127	545-625	30-35	.170	4.3
10	254	12	305	15Z21	65-75	30-35	8-10	2.9-3.8	74-96.5	630-710	40-45	.190	4.8
12	305	12	305	15Z21	55-65	30-35	10-12	2.4-3.0	61-76	790-905	45-55	.210	5.3
18	457	18 ¹	457	13A97	40-45	35-40	11-13	3.0-3.5	76-89	1,300-1,695	75-80	.320	8.1
20	508	20 ²	508	13A98	45-75	40-60	11-13	2.0-3.0	51-76	1,600-1,900	80-90	.360	9.1

¹Not recommended for acetylene pressure less than 5 psig.

²Sizes 18 and 20 recommended only for use with C-39.

Given pressures are torch inlet pressures, not what to set regulator at; hose length, diameter, flash arrestor use, and many other factors affect pressure. Use test gauge adaptors to check pressure at back of torch.

When using tips larger than 6 in. (152 mm), ESAB recommends using straight (hand) cutting torches, not combination torches.

1500 Group Tips

One-Piece Alternate Fuels



1564 Series Propylene Tips

Hand or Machine Cutting Tips

Metal Thickness		Tip Size		Part Number	Number Preheat Holes	Cleaning Preheat	Drill Size Cutting	
in.	mm	in.	mm				in.	m
1/8-1/2	10-19	1/2	13	638983	8	67	60	1.5
3/4-1-1/2	19-50	1-1/2	38	638984	8	64	53	1.3
2-4	50-100	4	100	638985	8	62	46	1.2
4-8	100-200	8	200	638986	8	59	39	1.0
8-12	200-300	12	300	638987	8	56	31	0.8

- General purpose
- Medium preheat sufficient for cutting dirty plate and for beveling



Operating Data

Metal Thickness		Tip Size		Part Number	Gas Pressure			Cutting Speed		Gas Consumption		Average Kerf Width	
					Cutting Oxygen	Preheat Oxygen	Propylene			Total Oxygen	Propylene		
in.	mm	in.	mm		psig	psig	psig	ipm	mm/min	cfh	cfh	in.	mm
1/4	6	1/2	13	638983	20-25	20-50	3-5	18-24	457-610	55-60	3-4	.050	1.3
1/2	13	1/2	13	638983	30-35	20-50	3-5	14-22	356-559	70-80	4-5	.065	1.7
3/4	19	1-1/2	38	638984	30-35	20-50	3-5	12-20	305-508	135-155	7-8	.080	2.0
1	25	1-1/2	38	638984	35-40	20-50	3-5	11-17	279-432	150-155	7-8	.090	2.3
1-1/2	38	1-1/2	38	638984	40-45	20-50	3-5	10-15	254-381	160-210	8-9	.095	2.4
2	51	4	102	638985	25-30	20-50	3-5	9-13	229-330	215-245	8-10	.100	2.5
3	76	4	102	638985	30-35	25-55	3-5	8-10	203-254	235-290	8-10	.105	2.7
4	102	4	102	638985	35-40	25-55	3-5	6-9	152-229	270-320	10-11	.115	2.9
5	127	8	203	638986	25-35	25-55	5-10	5-7	127-178	325-410	10-11	.125	3.2
6	152	8	203	638986	35-45	25-55	5-10	4-6	102-152	410-480	11-13	.170	4.3
8	203	8	203	638986	55-65	30-60	5-10	3.5-4.5	89-114	580-670	15-17	.187	4.7
10	254	12	305	638987	40-50	30-60	10-15	2.5-3.5	63.5-89	680-805	20-23	.210	5.3
12	305	12	305	638987	55-65	30-60	10-15	2.0-3.0	51-76	845-975	22-28	.240	6.1

Given pressures are torch inlet pressures, not what to set regulator at; hose length, diameter, flash arrestor use, and many other factors affect pressure. Use test gauge adaptors to check pressure at back of torch.

When using tips larger than 6 in. (152 mm), ESAB recommends using straight (hand) cutting torches, not combination torches.

1500 Group Tips

One-Piece Alternate Fuels



1515 Series Natural Gas & Propane Tips

Hand or Machine Cutting Tips

Metal Thickness		Tip Size		Part Number	Number Preheat Holes	Cleaning Preheat	Drill Size Cutting	
in.	mm	in.	mm				in.	m
1/8-1/2	10-13	1/2	13	08Z85	8	67	60	1.5
3/4-1-1/2	19-38	1-1/2	38	08Z86	8	64	53	1.3
2-4	50-100	4	100	08Z87	8	42	46	1.2
4-8	100-200	8	200	08Z88	8	59	39	1.0
8-12	200-300	12	300	08Z89	8	56	31	0.8
12-16	300-400	16	400	65Z12	12	54	20	0.5
16-18	400-450	18	450	65Z13	12	53	15	0.4
18-20	450-508	20	508	65Z14	12	52	8	0.2

■ One-piece natural gas or propane, long preheat flames



Operating Data

Metal Thickness		Tip Size		Part Number	Gas Pressure			Cutting Speed		Gas Consumption		Average Kerf Width	
					Cutting Oxygen	Preheat Oxygen	Propane or Natural Gas			Total Oxygen	Propane or Natural Gas		
in.	mm	in.	mm		psig	psig	psig	ipm	mm/min	cfh	cfh	in.	mm
1/4	6	1/2	13	08Z85	20-25	20-50	3-5	18-24	457-610	55-60	5-8	.050	1.3
1/2	13	1/2	13	08Z85	30-35	20-50	3-5	18-24	457-610	70-80	5-8	.065	1.7
3/4	19	1-1/2	38	08Z86	30-35	20-50	3-5	12-20	305-508	135-155	8-12	.080	2.0
1	254	1-1/2	38	08Z86	35-40	20-50	3-5	11-17	279-432	150-165	8-12	.090	2.3
1-1/2	38	1-1/2	38	08Z86	40-45	20-50	3-5	10-15	254-381	160-210	8-12	.095	2.4
2	51	4	100	08Z87	25-30	25-55	3-5	9-13	229-330	215-245	8-12	.100	2.5
3	76	4	100	08Z87	30-35	25-55	5-10	7-10	178-254	235-290	12-18	.105	2.7
4	100	4	100	08Z87	35-40	25-55	5-10	6-9	152-229	270-320	12-18	.115	2.9
5	127	8	200	08Z88	25-35	25-55	5-10	5-7	127-178	325-410	12-18	.125	3.2
6	152	8	200	08Z88	35-45	25-55	5-10	4-6	102-152	410-480	12-18	.170	4.3
8	200	8	200	08Z88	55-65	30-60	5-10	3.5-4.5	89-114	580-670	18-20	.187	4.7
10	254	12	300	08Z89	40-50	30-60	10-15	2.5-3.5	63.5-89	680-805	20-23	.210	5.3
12	300	12	300	08Z89	55-65	30-60	10-15	2.0-3.0	51-76	845-975	22-28	.240	6.1
16	400	16	400	65Z12	60-70	40-70	20-25	2.0-3.0	51-76	1,490-1,600	35-40	.300	7.6
18	450	18	450	65Z13	50-60	60-90	22-26	1.5-2	38-51	1,640-1,900	40-45	.340	8.6

Given pressures are torch inlet pressures, not what to set regulator at; hose length, diameter, flash arrestor use, and many other factors affect pressure. Use test gauge adaptors to check pressure at back of torch.

When using tips larger than 6 in. (152 mm), ESAB recommends using straight (hand) cutting torches, not combination torches.

1500 Group Tips

Two-Piece Alternate Fuels



1566 Series Alternate Fuels High Speed Tips

Machine Cutting Tips

Metal Thickness		Tip Size		Number Preheat Holes or Slots	Cleaning Preheat	Drill Size Cutting
in.	mm	in.	mm			
1/2	13	1/2	13	12	◇	#
3/4	19	3/4	19	12	◇	#
1	25	1	25	12	◇	#
1-1/2	38	1-1/2	38	12	◇	#
2	50	2	50	12	◇	#
2-1/2	64	2-1/2	64	12	◇	#
4	100	4	100	12	◇	#
6	150	6	150	12	◇	#
8	200	8	200	12	◇	#
10	250	10	250	16	◇	#
14	350	14	350	16	◇	#

■ Two-piece, high-speed, high preheat for machine cutting, alternate fuels



◇ To clean preheat slots, remove external sleeve and use a soft bristled brush.

Clean cutting orifice only with high speed tip cleaning kit #755F00.

Ordering Information

Metal Thickness		Natural Gas or Propane			Propylene			Propylene - High Preheat ¹		
in.	mm	Set Part Number	Internal	External	Set Part Number	Internal	External	Set Part Number	Internal	External
1/2	13	0558005072	639600	639322	0558005083	639600	998277	0558005094	639600	998557
3/4	19	0558005073	639601	639322	0558005084	639601	998277	0558005095	639601	998557
1	25	0558005074	639602	639322	0558005085	639602	998277	0558005096	639602	998557
1-1/2	38	0558005075	639603	639322	0558005086	639603	998277	0558005097	639603	998557
2	50	0558005076	639604	639322	0558005087	639604	998277	0558005098	639604	998557
2-1/2	64	0558005077	639605	639322	0558005088	639605	998277	0558005099	639605	998557
4	100	0558005078	639606	639322	0558005089	639606	998277	0558005100	639606	998557
6	150	0558005079	639607	639322	0558005090	639607	998277	0558005101	639607	998557
8	200	0558005080	998739	14Z39	0558005091	998739	114Z08	0558005102	998739	998561
10	250	0558005081	998740	14Z77	0558005092	998740	639755	0558005103	998740	998558
14	350	0558005082	998741	14Z77	0558005093	998741	639755	0558005104	998741	998558

¹Use where high preheat intensity is desired.

Operating Data

Metal Thickness		Tip Size		Internal Part Number	Gas Pressure			Cutting Speed			Gas Consumption		Average Kerf Width	
					Cutting Oxygen	Preheat Oxygen	Fuel				Total Oxygen	Fuel		
in.	mm	in.	mm	Number	psig	psig	psig	ipm	mm/min	cfh	cfh	in.	mm	
1/2	13	1/2	13	639600	90	20-50	3-5	21-26	533-660	60-80	5-10	.045	1.1	
3/4	19	3/4	19	639601	90	20-50	3-5	20-25	508-635	110-130	5-10	.055	1.4	
1	25	1	25	639602	90	20-50	3-5	18-23	457-584	120-140	8-15	.060	1.5	
1-1/2	38	1-1/2	38	639603	90	20-50	3-5	13-18	330-457	175-195	8-15	.080	2.0	
2	50	2	50	639604	90	20-50	3-5	12-17	305-432	265-285	8-15	.090	2.3	
2-1/2	64	2-1/2	64	639605	90	25-55	3-5	10-17	254-432	275-295	8-15	.105	2.7	
3	76	4	100	639606	90	25-55	5-10	8-15	203-381	275-295	15-20	.110	2.8	
4	100	4	100	639606	90	25-55	5-10	7-13	178-330	315-325	15-20	.115	2.9	
6	150	6	150	639607	90	25-55	5-10	6-10	152-254	330-350	15-20	.150	3.8	
8	200	8	200	998739	90	30-60	5-10	4-6	102-152	670-690	20-25	.160	4.1	
10	250	10	250	998740	90	30-60	10-15	3-4	76-102	705-730	25-30	.190	4.8	
12	305	14	350	998741	90	30-60	10-15	3-4	76-102	850-875	25-30	.210	5.3	
14	350	14	350	998741	90	35-65	15-20	2-4	51-102	1,110-1,135	25-30	.250	6.4	

Given pressures are torch inlet pressures, not what to set regulator at; hose length, diameter, flash arrestor use, and many other factors affect pressure. Use test gauge adaptors to check pressure at back of torch.

When using tips larger than 6 in. (152 mm), ESAB recommends using straight (hand) cutting torches, not combination torches.

Gas Apparatus

1500 Group Tips

Two-Piece Alternate Fuels



1567 Series

Hand or Machine Cutting Tips

Metal Thickness		Tip Size		Number Preheat Holes or Slots	Cleaning Preheat	Drill Size Cutting	
in.	mm	in.	mm			in.	m
1/4	6	1/4	6	12	◇	69	1.8
1/2	13	1/2	13	12	◇	65	1.7
3/4	19	3/4	19	12	◇	61	1.5
1	25	1	25	12	◇	54	1.4
2	50	2	50	12	◇	51	1.3
3	75	3	75	12	◇	49	1.2
4	100	4	100	16	◇	46	1.1
8	200	8	200	16	◇	39	1.0
12	300	12	300	16	◇	31	0.8
16	400	16	400	20	◇	20	0.5
18	500	18	500	20	◇	8	0.2

■ Two-piece, high preheat for machine cutting, alternate fuels



◇ To clean preheat slots, remove external sleeve and use a soft bristled brush.

Given pressures are torch inlet pressures, not what to set regulator at; hose length, diameter, flash arrestor use, and many other factors affect pressure. Use test gauge adaptors to check pressure at back of torch.

When using tips larger than 6 in. (152 mm), ESAB recommends using straight (hand) cutting torches, not combination torches.

Ordering Information

Metal Thickness		Natural Gas or Propane			Propylene			Propylene-High Preheat ¹		
in.	mm	Set Part Number	Internal	External	Set Part Number	Internal	External	Set Part Number	Internal	External
1/4	6	0558005016	639615	639322	0558005028	639615	998277	0558005040	639615	998557
1/2	13	0558005017	639616	639322	0558005029	639616	998277	0558005041	639616	998557
3/4	19	0558005018	639617	639322	0558005030	639617	998277	0558005042	639617	998557
1	25	0558005019	639618	639322	0558005031	639618	998277	0558005043	639618	998557
2	50	0558005020	639619	639322	0558005032	639619	998277	0558005044	639619	998557
3	75	0558005021	639620	639322	0558005033	639620	998277	0558005045	639620	998557
4	100	0558005022	998734	14Z39	0558005034	998734	114Z08	0558005046	998734	998561
8	200	0558005023	998735	14Z77	0558005035	998735	639755	0558005047	998735	998558
12	300	0558005024	998736	14Z77	0558005036	998736	639755	0558005048	998736	998558
16	400	0558005025	998737	14Z69	0558005037	998737	998269	0558005049	998737	998559
18	500	0558005026	998738	14Z69	0558005038	998738	998269	0558005050	998738	998559

¹Use where high preheat intensity is desired.

Operating Data

Metal Thickness		Tip Size		Internal Part Number	Gas Pressure		Cutting Speed		Gas Consumption		Average Kerf Width	
in.	mm	in.	mm		Cutting Oxygen	Fuel	ipm	mm/min	Total Oxygen	Fuel	in.	mm
				psig				cfh				
1/4	6	1/4	6	639615	40	3-5	20-25	508-635	45-65	5-10	.050	1.27
1/2	13	1/2	13	639616	40	3-5	18-25	457-635	65-85	5-10	.065	1.7
3/4	19	3/4	19	639617	40	3-5	15-24	381-610	70-90	5-10	.080	2.0
1	25	1	25	639618	40	3-5	14-20	356-508	95-115	5-10	.090	2.3
1-1/2	38	2	50	639619	40	3-5	12-16	305-406	175-200	8-15	.095	2.4
2	50	2	50	639619	40	3-5	10-14	254-356	175-200	8-15	.100	2.5
2-1/2	64	3	76	639620	40	3-5	8-12	203-305	235-260	8-15	.105	2.7
3	76	3	76	639620	40	5-10	7-11	178-279	235-260	15-20	.105	2.7
4	100	4	100	998734	40	5-10	6-10	152-254	300-335	15-20	.115	2.9
6	150	8	200	998735	39	5-10	4-6	102-152	450-480	15-20	.170	4.3
8	200	8	200	998735	55-60	5-10	3-5	76-127	560-590	20-25	.187	4.7
10	250	12	305	998736	50-60	10-15	3-4	76-102	840-900	25-30	.210	5.3
12	305	12	305	998736	60-70	10-15	3-4	76-102	900-970	25-30	.240	6.1
14	350	16	400	998737	50-60	15-20	3-4	76-102	1,120-1,340	25-30	.270	6.9
16	400	16	400	998737	60-70	15-20	2-3	51-76	1,340-1,480	30-35	.300	7.6
18	500	18	500	998738	50-60	15-20	2-3	51-76	1,560-1,890	30-35	.340	8.6

Gas Apparatus

1500 Group Tips Specialty



1539 Series Alternate Fuels Tips

Special Tips Propylene, Natural Gas, Propane

Tip Size		Number Preheat Holes	Part Number	Cleaning Preheat	Drill Size Cutting	
in.	mm				in.	mm
19'	483	10	65Z55	62	3/16	4.8
19 ²	483	10	65Z50	62	3/16	4.8
25	635	10	65Z56	62	1/4	6.4

- Unsurpassed for washing off rivet heads and then piercing rivet to facilitate removal
- Each tip is equipped with a spud, which produces a low-velocity oxygen stream

Operating Data

Tip Size		Part Number	Gas Pressure	
			Cutting Oxygen	Fuel
in.	mm		psig	psig
19 ¹	483	65Z55	80-90	5-7
19 ²	483	65Z50	50-60	5-7
25	635	65Z56	50-60	5-7



¹Spudded for maximum useful oxygen flow at 80-90 psi.
²Spudded for maximum useful oxygen flow at 50-60 psi.
³The cutting oxygen throat diameter is 0.055 in. (1.4 mm) on #65Z55; 0.125 in. (3.2 mm) on #66Z50.

Given pressures are torch inlet pressures, not what to set regulator at; hose length, diameter, flash arrestor use, and many other factors affect pressure. Use test gauge adaptors to check pressure at back of torch.

When using tips larger than 6 in. (152 mm), ESAB recommends using straight (hand) cutting torches, not combination torches.

Gas Apparatus

1516 Series Acetylene Tips

Special Tips Acetylene

Tip Size		Number Preheat Holes	Part Number	Cleaning Preheat	Drill Size Cutting	
in.	mm				in.	m
6	152	4	65Z22	65	53	1.3

- For cutting and trimming



Operating Data

Metal Thickness		Tip Size		Part Number	Gas Pressure		Gas Consumption	
					Oxygen	Acetylene	Total Oxygen	Acetylene
in.	mm	in.	mm		psig	psig	cfh	cfh
3/4-1-1/2	19-38	6	152	65Z22	35-40	5-7	120-150	15-20

Given pressures are torch inlet pressures, not what to set regulator at; hose length, diameter, flash arrestor use, and many other factors affect pressure. Use test gauge adaptors to check pressure at back of torch.

When using tips larger than 6 in. (152 mm), ESAB recommends using straight (hand) cutting torches, not combination torches.

1500 Group Tips Specialty



1510 Series Acetylene Tips

Special Tips Acetylene

Tip Size		Number Preheat Holes	Cleaning Preheat	Drill Size Cutting	
in.	mm			in.	m
8	203	12	◇	76	1.9
10	254	12	◇	68	1.7
12	305	6	◇	46	1.2

- For riser removal
- Except in length, comparable to 1502
- Supplied straight, with instructions for bending



◇For preheat cleaning size, reference 1502 group series cleaning preheat column.

Operating Data

Metal Thickness		Tip Size		Part Number	Gas Pressure			Cutting Speed		Gas Consumption		Average Kerf Width	
					Cutting Oxygen	Preheat Oxygen	Acetylene			Total Oxygen	Acetylene		
in.	mm	in.	mm		psig	psig	psig	ipm	mm/min	cfh	cfh	in.	mm
2	50	8	203	08Z40	25-30	15-25	6-8	10-14	254-355	185-210	16-20	.095	2.4
3	76	8	203	08Z40	30-40	15-25	6-8	8-11	203-280	205-255	16-20	.100	2.5
4	100	8	203	08Z40	35-40	15-25	6-8	6-9	152-229	235-285	19-22	.105	2.7
6	150	10	250	08Z41	35-40	20-30	6-10	5-7	127-178	395-460	20-25	.157	4.0
8	203	10	250	08Z41	55-65	20-30	6-10	4-5	102-127	545-625	30-35	.170	4.3
10	250	12	300	08Z42	40-55	20-30	6-10	3-4	76-102	630-710	40-55	.190	4.8
12	300	12	300	08Z42	55-65	20-30	10-12	3-4	76-102	790-905	45-55	.210	5.3

Gas Apparatus

1511, 1520 & 1568 Tips

Special Tips Acetylene, Propylene, Natural Gas & Propane

Tip Size		For Acetylene	For Propane	For FG-2	Cleaning Preheat	Drill Size Cutting	
in.	mm	1511 Series	Natural Gas 1520 Series	MAPP 1568 Series		in.	m
13	330	15X14	15X33	998273	56	55	1.4
19	483	15X15	15X34	998274	55	49	1.2

- For gouging, grooving plate edges for welding, removing defects from castings, pad washing; bent 20°

- 1511 and 1568 tips have stellite wear skids

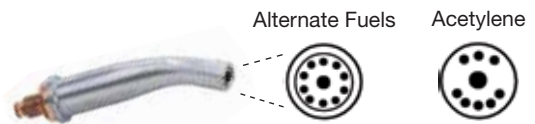

Operating Data for Series 1511

Tip Size		Part Number	Approximate Groove Dimensions				Gas Pressure-PSIG		Approximate Speed		Gas Consumption	
			Width		Depth		Cutting Oxygen	Acetylene			Oxygen	Acetylene
in.	mm		in.	mm	in.	mm	psig	psig	ft/min	m/min	cfh	cfh
13	330	15X14	5/16	8.0	1/8-1/4	3.2-6.4	65-75	5-10	1.0-1.8	0.3-0.5	160-180	35-80
19	483	15X15	3/8-7/16	9.5-11	3/16-1/8	4.8-3.2	80-90	5-10	1.6-2.2	0.5-0.7	270-300	50-55

Given pressures are torch inlet pressures, not what to set regulator at; hose length, diameter, flash arrestor use, and many other factors affect pressure. Use test gauge adaptors to check pressure at back of torch.

When using tips larger than 6 in. (152 mm), ESAB recommends using straight (hand) cutting torches, not combination torches.

4200 Group Tips

One-Piece Acetylene



4202 Series Acetylene Tips

Hand Cutting Tips

Metal Thickness		Tip Size		Part Number	Number Preheat Holes	Cleaning Preheat	Drill Size Cutting	
in.	mm	in.	mm				in.	m
1/8	3	1/8	3	638869	4	73	76	1.9
3/16-1/4	4-6	1/4	6	16K08	6	73	68	1.7
1/2	13	1/2	13	16K09	6	73	60	1.5
3/4-1-1/2	19-38	1-1/2	38	16K10	6	69	55	1.4
2-4	50-100	4	100	16K11	6	68	50	1.3
6	150	6	150	16K12	6	64	43	1.1
8-10	200-250	10	250	16K13	6	60	35	0.9
12	300	12	300	16K14	6	56	30	0.8

- General purpose
- Medium preheat, sufficient for beveling



Operating Data

Metal Thickness		Tip Size		Part Number	Gas Pressure		Cutting Speed		Gas Consumption		Average Kerf Width	
					Cutting Oxygen	Acetylene			Total Oxygen	Acetylene		
in.	mm	in.	mm		psig	psig	ipm	mm/min	cfh	cfh	in.	mm
1/16	1.6	1/8	3.2	638869	30-40	5-7	36-40	914-1016	20-25	5-8	.050	1.3
1/8	3.2	1/8	3.2	638869	30-40	5-7	34-38	864-965	25-32	8-10	.055	1.4
1/4	6	1/4	6.4	16K08	30-40	5-7	28-32	711-813	38-45	8-10	.055	1.4
3/8	9.5	1/2	13	16K09	30-40	5-7	23-27	584-685.5	55-60	9-11	.060	1.5
1/2	13	1/2	13	16K09	30-40	5-7	18-22	457-589	70-75	10-12	.065	1.7
5/8	16	1-1/2	38	16K10	30-40	5-7	16-20	406-508	78-83	10-12	.070	1.8
3/4	19	1-1/2	38	16K10	30-40	5-7	14-18	356-457	95-102	12-14	.075	1.9
1	25	1-1/2	38	16K10	35-40	5-7	13-15	330-381	120-125	14-16	.080	2.0
1-1/2	38	1-1/2	38	16K10	50-55	5-7	11-13	279-330	168-175	16-20	.090	2.3
2	50	4	100	16K11	40-45	6-10	10-12	254-305	195-205	18-20	.095	2.4
3	76	4	100	16K11	50-60	6-10	10-11	254-279	230-240	18-22	.100	2.5
4	100	4	100	16K11	60-75	6-10	8-10	203-254	300-325	21-25	.110	2.8
5	127	6	152	16K12	60-70	10-12	7-9	178-229	340-380	22-25	.130	3.3
6	152	6	152	16K12	60-70	10-12	6-8	152-203	410-460	25-28	.160	4.0
8	200	10	250	16K13	65-75	10-12	4-6	102-152	600-640	30-35	.170	4.3
10	250	10	250	16K13	80-90	10-12	1-2	25-50	680-740	40-45	.190	4.8
12	305	12	305	16K14	75-85	10-12	1-2	25-50	800-860	48-52	.210	5.3

Gas Apparatus

4216 Series Propylene Tips

Hand Cutting Tips

Metal Thickness		Tip Size		Part Number	Number Preheat Holes	Cleaning Preheat	Drill Size Cutting	
in.	mm	in.	mm				in.	m
1/8-1/4	3-6	1/4	6	998589	8	67	68	1.7
1/2	13	1/2	13	998590	8	67	60	1.5
3/4-1-1/2	19-38	1-1/2	38	998591	8	64	53	1.3
2-4	50-100	4	100	998592	8	62	46	1.2
6-8	150-200	8	200	998593	8	59	39	1.0

- Heavy preheat for scrap cutting and beveling in excess of 45°
- See torch datapage for operating data



Given pressures are torch inlet pressures, not what to set regulator at; hose length, diameter, flash arrestor use, and many other factors affect pressure. Use test gauge adaptors to check pressure at back of torch.

When using tips larger than 6 in. (152 mm), ESAB recommends using straight (hand) cutting torches, not combination torches.

4200 Group Tips

One-Piece Alternate Fuels



4203 Series Natural Gas & Propane Tips

Hand Cutting Tips

Metal Thickness		Tip Size		Part Number	Number Preheat Holes	Cleaning Preheat	Drill Size Cutting	
in.	mm	in.	mm				in.	m
3/8-5/8	9-15	3/4	19	16K15	6	73	60	1.5
3/4-1-1/2	19-38	1-1/2	38	16K16	6	69	55	1.4
2-4	50-100	4	100	16K17	6	68	50	1.3
5-6	125-150	6	150	16K18	6	64	43	1.1

- General purpose cutting with natural gas or propane
- Medium preheat sufficient for beveling



Operating Data

Metal Thickness		Tip Size		Part Number	Gas Pressure		Cutting Speed		Gas Consumption		Average Kerf Width	
					Cutting Oxygen	Propane or Natural Gas			Total Oxygen	Propane or Natural Gas		
in.	mm	in.	mm		psig	psig	ipm	mm/min	cfh	cfh	in.	mm
3/8	9	4	100	16K15	20-28	3-5	19-23	483-584	70-80	6-8	.060	1.5
1/2	13	4	100	16K15	30-35	3-5	17-21	432-533	80-100	8-10	.065	1.7
5/8	15	4	100	16K15	38-45	3-5	15-19	381-483	110-120	9-11	.070	1.8
3/4	19	5	125	16K15	25-30	3-5	15-19	381-483	125-140	9-11	.075	1.9
1	25	5	125	16K16	30-40	3-5	13-17	330-432	140-150	10-12	.080	2.0
1-1/2	38	5	125	16K16	48-62	3-5	11-15	280-381	190-210	12-14	.090	2.3
2	50	7	180	16K17	35-44	5-10	10-14	254-356	225-245	12-16	.095	2.4
3	76	7	180	16K17	40-56	5-10	8-10	203-356	250-290	13-18	.100	2.5
4	100	7	180	16K17	62-74	5-10	7-9	180-230	300-340	14-18	.110	2.8
5	130	9	230	16K18	58-62	10-15	3-4	76-100	400-450	15-20	.130	3.3
6	150	9	230	16K18	68-74	10-15	3-4	76-100	470-520	16-20	.170	4.3

Given pressures are torch inlet pressures, not what to set regulator at; hose length, diameter, flash arrestor use, and many other factors affect pressure. Use test gauge adaptors to check pressure at back of torch.

When using tips larger than 6 in. (152 mm), ESAB recommends using straight (hand) cutting torches, not combination torches.

4200 Group Tips

Two-Piece Alternate Fuels



4217 Series

Hand Cutting Tips

Metal Thickness		Tip Size		One-Piece or Internal Part Number	External Sleeve Natural Gas Propane	Number Preheat Holes	Cleaning Preheat	Drill Size Cutting	
in.	mm	in.	mm					in.	m
1/4	6	1/4	6	19485	19518	12	◇	68	1.7
1/2	13	1/2	13	19486	19518	12	◇	60	1.5
1	25	1	25	19487	19518	12	◇	53	1.3
2	50	2	50	19488	19518	12	◇	50	1.3
4	100	4	100	19489	19519	20	◇	43	1.1
6	150	6	150	19490	19519	20	◇	39	1.0
8	200	8	200	19491	19519	20	◇	35	0.9
12	300	12	300	19492	19519	20	◇	31	0.8

- General purpose
- Medium preheat sufficient for beveling



◇Use soft bristled brush to clean preheat slots of internals.

Ordering Information

Metal Thickness		Alternate Fuels		
in.	mm	Set Part Number	Internal	External
1/4	6	0558005123	19485	19518
1/2	13	0558005124	19486	19518
1	25	0558005125	19487	19518
2	50	0558005126	19488	19518
4	100	0558005127	19489	19519
6	150	0558005128	19490	19519
8	200	0558005129	19491	19519
12	300	0558005130	19492	19519

Gas Apparatus

Operating Data

Metal Thickness Tip Size		Internal Part Number	Gas Pressure				Gas Consumption				Cleaning Drill Size	
in.	mm		Oxygen psig	Propylene psig	Propane psig	Natural Gas ¹ psig	Oxygen cfh	Propylene cfh	Propane cfh	Natural Gas cfh	in.	m
1/4	6	19485	30	4	6	7	70	8	12	30	68	1.7
1/2	13	19486	35	4	7	8	120	9	14	32	60	1.5
1	25	19487	40	4	8	9	180	10	15	35	53	1.3
2	50	19488	45	5	9	10	250	11	16	40	50	1.3
4	100	19489	40	4	8	10	370	12	18	45	43	1.1
6	150	19490	50	5	12	13	520	14	20	50	39	1.0
8	200	19491	50	6	15	16	610	16	22	55	35	0.9
12	300	19492	75	8	18	20	860	20	30	85	31	0.8

Given pressures are torch inlet pressures, not what to set regulator at; hose length, diameter, flash arrestor use, and many other factors affect pressure. Use test gauge adaptors to check pressure at back of torch.

When using tips larger than 6 in. (152 mm), ESAB recommends using straight (hand) cutting torches, not combination torches.

4200 Group Tips Specialty



4206 Series Acetylene Tips

Special Tips Acetylene

Tip Size		No Preheat Holes	Part Number	Drill Size Cutting
in.	mm			
3/16	5	5	16K33	68

■ Light preheat for cutting sheet metal



4207 & 4218 Tips

Special Tips Acetylene, Propylene-Gouging

■ Designed for grooving, gouging, and plate edge preparation

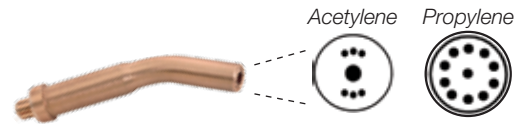

Operating Data

Tip Series	Approximate Groove Dimensions						Part Number	Gas Pressure			Gas Consumption			Gouging Speed	
	Width		Depth		Tip Size			Oxygen	Acetylene	Propylene	Oxygen	Total Acetylene	Propylene		
	in.	mm	in.	mm	in.	mm		psig	psig	psig	cfh	cfh	cfh		
4207	1/4-5/16	6-8	1/8-1/4	3-6	13	330	16K67	35-40	9-10	-	157-180	33-38	-	1.0-1.8	0.3-0.5
4207	3/8-7/16	9.5-11	1/4-3/8	6-9.5	19	483	16K35	45-50	12-14	-	268-303	50-55	-	1.6-2.2	0.5-0.7
4218	3/8-7/16	9.5-11	1/4-3/8	6-9.5	18	457	0558011948	80-90	-	5-10	270-300	-	50-55	1.6-2.2	0.5-0.7

Gas Apparatus

4209 Series Acetylene Tips

Special Tips Hand Cutting, Gouging, Groove Cutting

Rivet or Bolt Diameter		Tip Size		Number Preheat Holes	Part Number
in.	mm	in.	mm		
5/8-3/4	16-19	5	127	2	16K47

■ Designed for rivet busting and bolt removal



Operating Data

Rivet or Bolt Diameter		Tip Size		Part Number	Gas Pressure		Gas Consumption	
in.	mm	in.	mm		Oxygen	Acetylene	Oxygen	Total Acetylene
					psig	psig	cfh	cfh
5/8-3/4	16-19	5	127	16K47	20-35	3-5	85-92	12-14

Given pressures are torch inlet pressures, not what to set regulator at; hose length, diameter, flash arrestor use, and many other factors affect pressure. Use test gauge adaptors to check pressure at back of torch.

When using tips larger than 6 in. (152 mm), ESAB recommends using straight (hand) cutting torches, not combination torches.

Cutting Tips

Victor Style



Series 1 Acetylene Tips

Hand or Machine Cutting Tips

Metal Thickness		Tip Size	Part Number
in.	mm		
1/8	3	000	Q1-101-000
1/4	6	00	Q1-101-00
1/2	13	0	Q1-101-0
3/4	19	1	Q1-101-1
1-1/2	38	2	Q1-101-2
2-1/2	63	3	Q1-101-3
3	75	4	Q1-101-4
5	125	5	Q1-101-5
8	200	6	Q1-101-6
10	250	7	Q1-101-7
12	300	8	Q1-101-8

■ General purpose



Series 3 Acetylene Tips

Hand or Machine Cutting Tips

Metal Thickness		Tip Size	Part Number
in.	mm		
1/8	3	000	Q3-101-000
1/4	6	00	Q3-101-00
1/2	13	0	Q3-101-0
3/4	19	1	Q3-101-1
1-1/2	38	2	Q3-101-2
2-1/2	63	3	Q3-101-3
3	75	4	Q3-101-4
5	125	5	Q3-101-5

■ General purpose



Gas Apparatus

Series 1 & Series 3 Operating Data

Metal Thickness		Tip Size	Gas Pressure		Cutting Speed		Gas Consumption		Average Kerf Width	
			Cutting Oxygen	Acetylene			Total Oxygen	Acetylene		
in.	mm		psig	psig	ipm	mm/min	cfh	cfh	in.	mm
1/8	3	000	20-25	3-5	28-32	711-813	20-25	3-5	0.04	1.0
1/4	6	00	20-25	3-5	27-30	685.5-762	30-35	4-6	0.05	1.3
3/8	9.5	0	25-30	3-5	24-28	610-711	55-60	5-8	0.06	1.5
1/2	13	0	30-35	3-5	20-24	508-610	60-65	6-10	0.06	1.5
3/4	19	1	30-35	3-5	17-21	432-533	80-85	8-13	0.07	1.8
1	25	2	35-40	3-6	15-19	381-483	140-150	10-16	0.09	2.3
1-1/2	38	2	40-45	3-7	13-17	330-432	150-160	12-18	0.09	2.3
2	50	3	40-45	4-9	12-15	305-380	210-225	14-22	0.11	2.8
2-1/2	63	3	45-50	4-10	10-13	254-330	225-240	16-26	0.11	2.8
3	75	4	40-50	5-10	9-12	230-305	270-320	18-30	0.12	3.0
4	100	5	45-55	5-12	8-11	203-280	390-425	22-34	0.15	3.8
5	125	5	50-55	5-13	7-9	180-230	425-450	26-38	0.15	3.8
6	150	6	45-55	7-13	6-8	152-203	500-600	30-44	0.18	4.6
8	200	6	45-55	7-14	5-6	130-152	500-600	34-50	0.19	4.8

Victor® is a registered trademark of Thermadyne Holdings Corporation.

Given pressures are torch inlet pressures, not what to set regulator at; hose length, diameter, flash arrestor use, and many other factors affect pressure. Use test gauge adaptors to check pressure at back of torch.

When using tips larger than 6 in. (152 mm), ESAB recommends using straight (hand) cutting torches, not combination torches.

Regulators

Product Offering Guide



Cylinder

Regulators

Extra Heavy-Duty

Two-Stage
R-770

R-770



Single-Stage
R-760

R-760



Medium/Heavy-Duty

Single-Stage
R-720

R-720



Station Drop/Line

Regulators

Extra Heavy-Duty

Single-Stage
R-760
R-6700

R-760



Medium/Heavy-Duty

Single-Stage
R-720

R-720



Regulator/Flowmeters

Extra Heavy-Duty

Two-Stage Inert
R-502-FM-580

Single-Stage Inert
R-5007-FM-580

Single-Stage Carbon Dioxide
R-5008-FM-320

Medium/Heavy-Duty

Single-Stage Inert
R-720-FM-580
R-33-FM-580
R-50-FM-580

Single-Stage Carbon Dioxide
R-33-FM-320



R-33-FM-580

Flowmeters

Medium/Heavy-Duty

Single-Stage Inert
L-32
L-33

Single-Stage Carbon Dioxide
L-32
L-33



L-32

For Steel Industry regulators, see "SIP" Section.

Controlled Flow Regulators

Extra Heavy-Duty

Single-Stage Inert
R-760-CF-320

Medium/Heavy-Duty

Single-Stage Inert
R-720-CF-580



R-720-CF-580

Cylinder Regulators

OXWELD® and PUROX® Elite Series

Why Choose ESAB?

Purox Elite Series R-720 shown

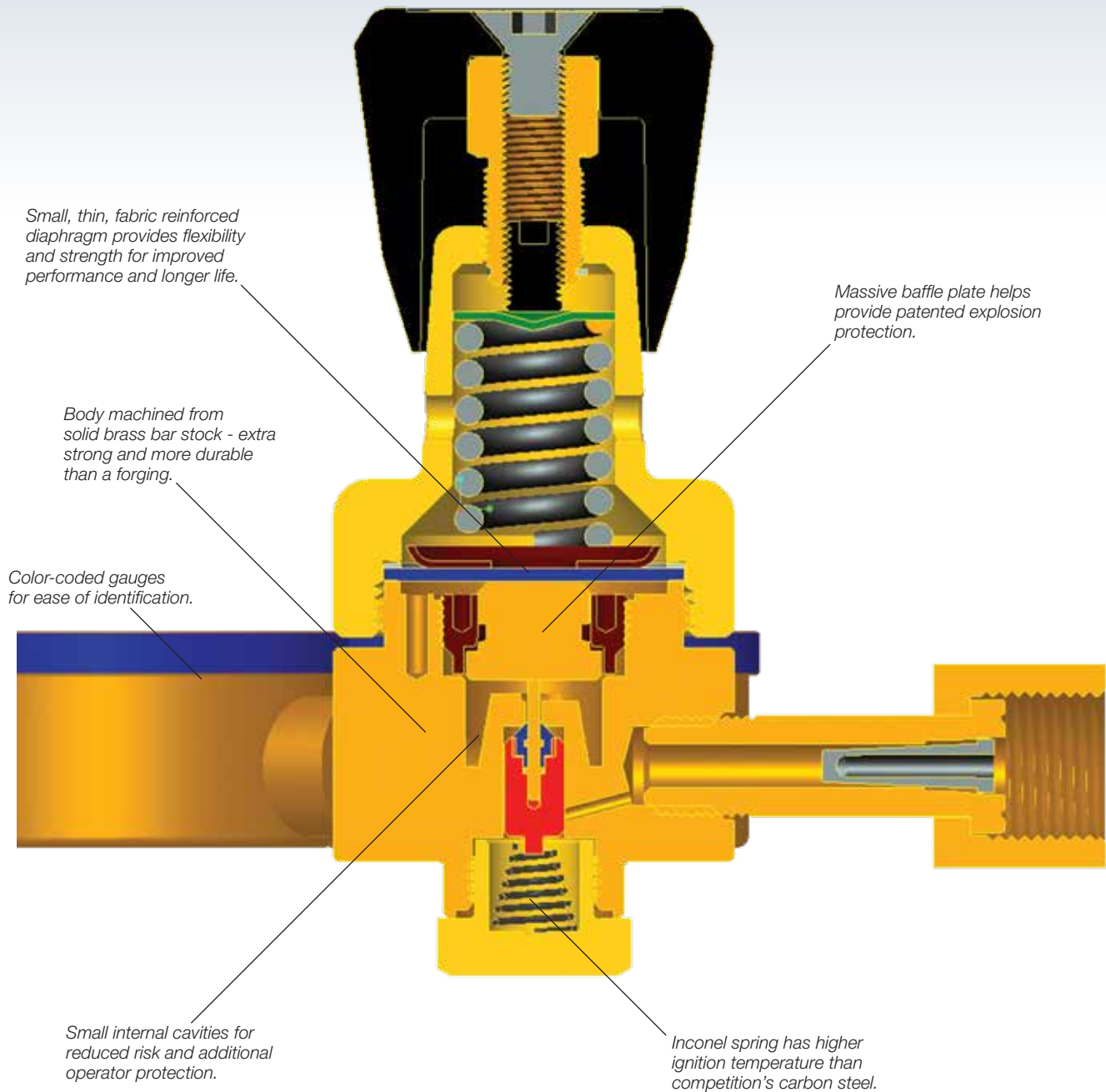

Small, thin, fabric reinforced diaphragm provides flexibility and strength for improved performance and longer life.

Massive baffle plate helps provide patented explosion protection.

Body machined from solid brass bar stock - extra strong and more durable than a forging.

Color-coded gauges for ease of identification.

Small internal cavities for reduced risk and additional operator protection.

Inconel spring has higher ignition temperature than competition's carbon steel.

Gas Apparatus

Cylinder Regulators

OXWELD® and PUROX® Elite Series

Regulators

ESAB manufactures a complete line of regulators that are unsurpassed in their field. They have the capacity to handle virtually all gas and electric welding, cutting, heating, and related process applications ranging from light-duty maintenance and repair operations through general- and heavy-duty production. All regulators meet UL listing requirements.

Cylinder-Based Explosions

When oxygen comes in contact with certain impurities, especially a hydrocarbon, spontaneous ignition can occur. When this happens in the inner chambers of an oxygen regulator, it causes a cylinder-based fire or explosion.

Explosions can occur when prescribed practices for the safe handling and use of cylinders and regulators are not followed. Regulator pieces can become burning projectiles and cause serious personal injuries.

Because any regulator can be used contrary to the manufacturer's warnings and instructions, it is impossible to guarantee that an explosion will not occur. After years of research and development, ESAB has achieved an advance in regulator design that makes a cylinder explosion more likely to be contained if a regulator is misused.

In extensive tests where we simulated operator misuse, ESAB regulators were more effective at minimizing the risk of personal injury than any of the competitive brand single- or two-stage models that were tested.

Further, the explosion protection that is built into our exclusive design has been patented and added to all ESAB cylinder oxygen regulators.

Single-Stage or Two-Stage Regulators

All regulators are used to reduce the gas pressure supplied by a high pressure source to a precise workable level that can be handled by the equipment being used. Both single- and two-stage regulators control only the gas pressure - not the flow rate, unless equipped with a flow control device.

Single-Stage Regulators

Reduce pressure in one step. Changes in input pressure will cause changes in output pressure. Since the cylinder pressure will decrease as the cylinder empties, it is necessary to make occasional readjustments for consistent output pressure. Where input pressure remains constant, such as from liquified gas sources or controlled line supplies, no adjustments are necessary.

Two-Stage Regulators

Reduce pressure in two steps. They are actually two regulators in one. The first stage reduces the input pressure to a preset intermediate pressure, which becomes the input pressure to the second stage. Because the intermediate pressure is regulated, the delivery pressure of the regulator remains virtually constant. As a result, cylinders can be used to much lower pressures for increased gas savings for our customers - up to 10% of full cylinder content savings, depending on regulator service.

Gauge-less Regulators

In applications where the gauges are subject to frequent damage, gauge-less regulators are often preferred. A spring-loaded, pop-up indicator retracts when the cylinder is nearly empty. A sliding indicator in the regulator cap is used to indicate delivery pressure.

This regulator without explosion protection experienced a regulator burnout (RBO)

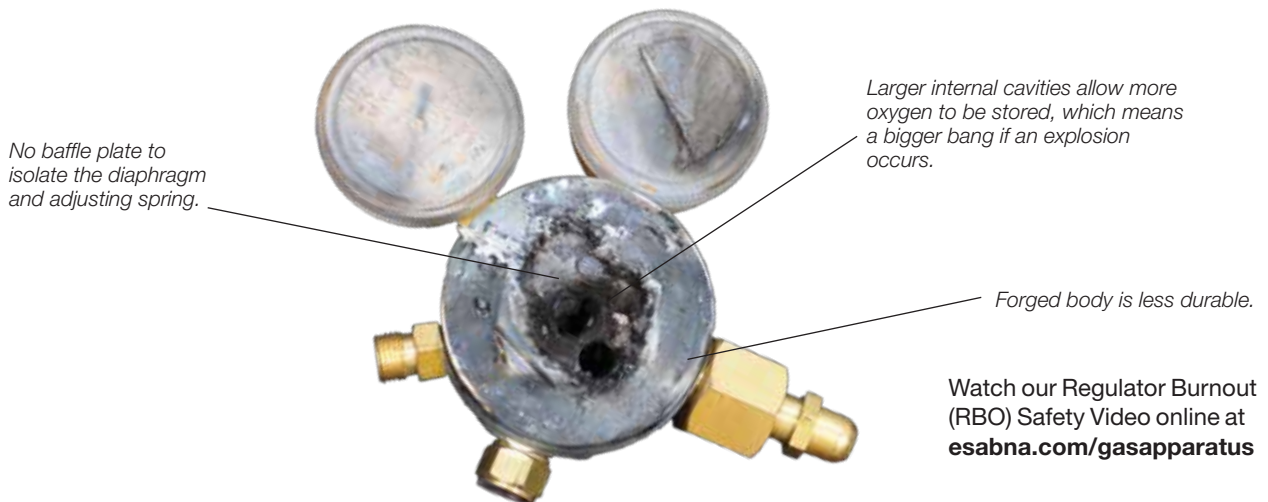

Cylinder Regulators

OXWELD® and PUROX® Elite Series



Ease of Identification



Flow data provides an aid to proper regulator selection. The regulators are rated with standard CGA fittings. Other factors to consider include hose diameter and length, valve, and gas apparatus combinations. If more detailed information is required for a specific application, consult your distributor for assistance.

To find the flow rate for a particular regulator and gas, refer to the appropriate curve and the correction factor, if any, noted below the curves. The following example will help in reading the curves:

In Figure 3, the helium flow rate for an R-770-500-580 regulator, given a delivery pressure of 240 psig and inlet pressure of 300 psig, is determined by multiplying the curve reading of 1,000 cfh by the correction factor of 2.7. The flow rate, therefore, is 2,700 cfh.

For other gases, multiply oxygen flow rate by: 0.9 for argon and FG-2; 1.1 for nitrogen; 1.4 for natural gas; 2.8 for helium; 4.0 for hydrogen.

For other gases, multiply nitrogen flow rate by 0.8 for argon; 2.7 for helium.

Outlet Connection:

- CGA-022 (formerly "B" oxygen) - 9/16 in. - 18 RH male connection
- CGA-023 (formerly "B" fuel gas) - 9/16 in. - 18 LH male connection
- CGA-032 (formerly "B" inert gas) - 5/8 in. - 18 RH female connection
- CGA-033 (formerly "B" air-water) - 5/8 in. - 18 LH female connection
- CGA-020 (formerly "A" oxygen) - 3/8 in. - 24 RH male connection
- CGA-021 (formerly "A" fuel gas) - 3/8 in. - 24 LH male connection

Figure 1 — R-770-150-540, -350, -580, -590, -680

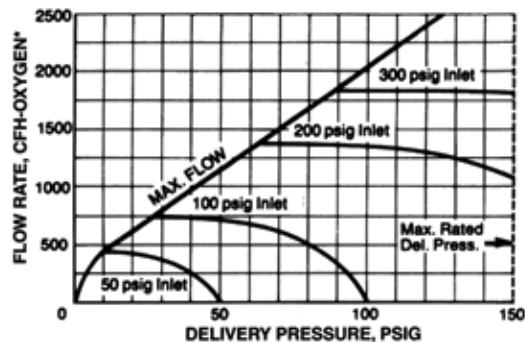

Figure 2 — R-770-200-540

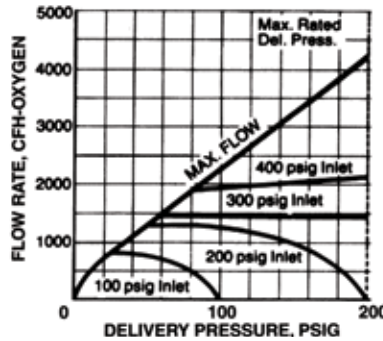
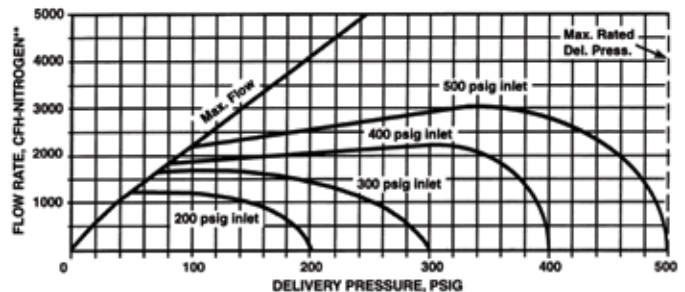

Figure 3 — R-770-500-580



Gas Apparatus

R-770 Series - Cylinder

OXWELD® Elite Series, Two-Stage Regulators



- Improved design
- RBO production reduces risk of oxygen regulator burnout
- Two stages for accurate delivery pressure over life of a cylinder
- Replaces R-77 model



R-770

Specifications

Weight		Length		Body Diameter		Gauge Size	
lbs.	kg	in.	mm	in.	mm	in.	mm
6	2.8	8-1/4	210	2-3/8	60	2-1/2	63.5

Figure 4 - R-770-15-510, -300

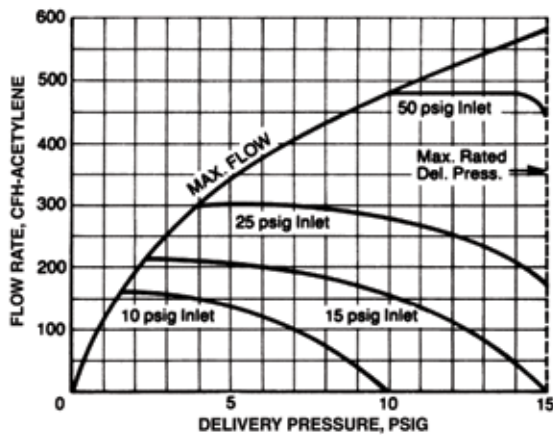
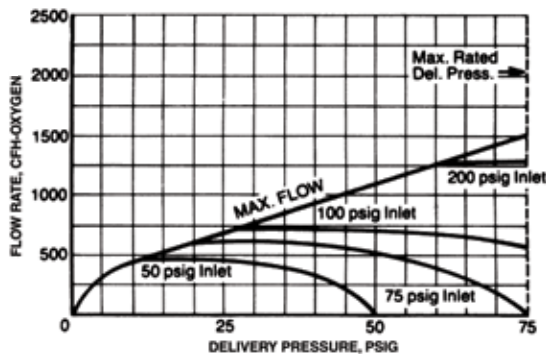

Figure 5 - R-770-75-540, -350, -580, -577, -701



Ordering Information

Model	Part Number	CGA Outlet
Oxygen		
R-770-75-540	0558010675	022
R-770-150-540	0558010676	022
R-770-200-540	0558010677	022
Acetylene		
R-770-15-510	0558010685	023
R-770-15-300	0558010678	023
Hydrogen or Methane¹		
R-770-75-350	0558010679	023
R-770-150-350	0558010680	023
Inert		
R-770-15-580	0558010674	032
R-770-30-580	0558010672	032
R-770-75-580	0558010681	032
R-770-150-580	0558010682	032
R-770-500-580	0558010683	1/4 in. 37° flared
Air		
Industrial R-770-150-590	0558010684	033
Breathing R-770-150-346	0558010673	022

¹Bottled natural gas.

Options & Accessories

Gauge guard 999965

R-760 Series - Cylinder

OXWELD® Elite Series, Single-Stage Regulators



- Improved design
- RBO production reduces risk of oxygen regulator blowout
- Pressure adjusting knob for accuracy
- Replaces R-76 model
- Single-stage version of R-770



R-760

Specifications

Weight		Length		Body Diameter		Gauge Size	
lbs.	kg	in.	mm	in.	mm	in.	mm
5-1/2	2.5	6-1/2	165	2-3/8	60	2-1/2	63.5

Figure 6 - R-760-15-510, -300

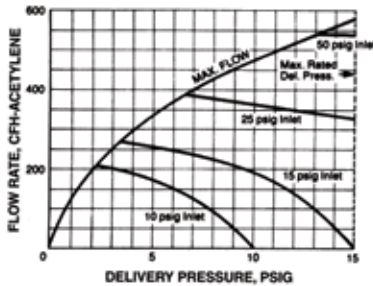

Figure 7 - R-760-75-540, -510, -350

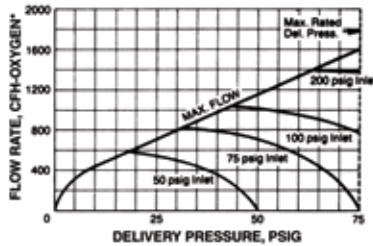

Figure 8 - R-760-150-540, -580

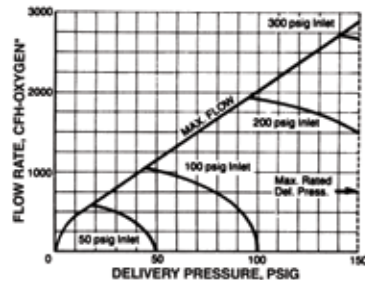
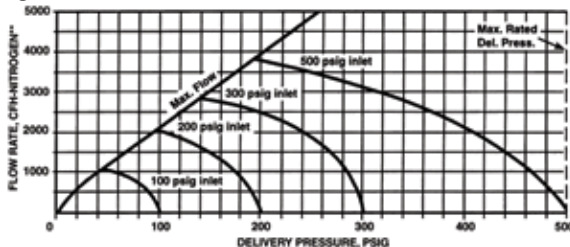

Figure 9 - R-760-500-586



Ordering Information

Model	Part Number	CGA Outlet
Oxygen		
R-760-75-540	0558010663	022
R-760-150-540	0558010664	022
Acetylene		
R-760-15-510	0558011373	023
R-760-15-300	0558010665	023
Propylene or Propane		
R-760-75-510	0558010668	023
Hydrogen or Methane¹		
R-760-75-350	0558010669	023
Inert		
R-760-150-580	0558010670	032
R-760-500-580	0558010671	1/4 in., 37° flared
Carbon Dioxide		
R-760-150-320	0558010659	032
R-760-CF-320	999149	032
Air		
Breathing R-760-150-346	0558010653	032
Liquid		
Oxygen R-760-150-540	0558010660	022
Inert R-760-150-580	0558010661	032
Gauge-less		
Oxygen R-760-150-540G	0558010666	022
Acetylene R-760-15-510G	0558010667	023

¹Bottled natural gas.

Options & Accessories

Gauge Guard 999965

Gas Apparatus

R-720 Series - Cylinder

PUROX® Elite Series, Single-Stage Regulators



- Improved design
- RBO protection reduces risk of oxygen regulator burnout
- Pressure adjusting knob for accuracy
- Replaces R-72 model



R-720

Specifications

Weight		Length		Body Diameter		Gauge Size	
lbs.	kg	in.	mm	in.	mm	in.	mm
3-1/4	1.5	5	127	2-1/4	57	2-1/2	63.5

Figure 10 - R-720-75-540, -510

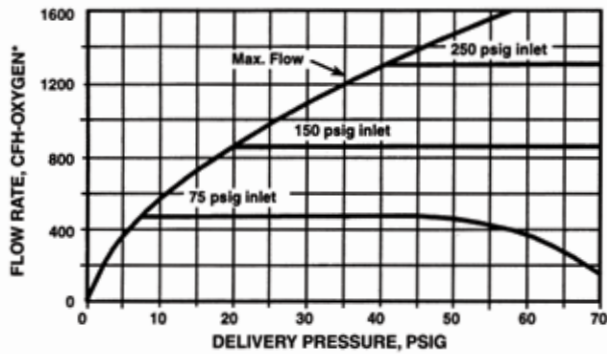
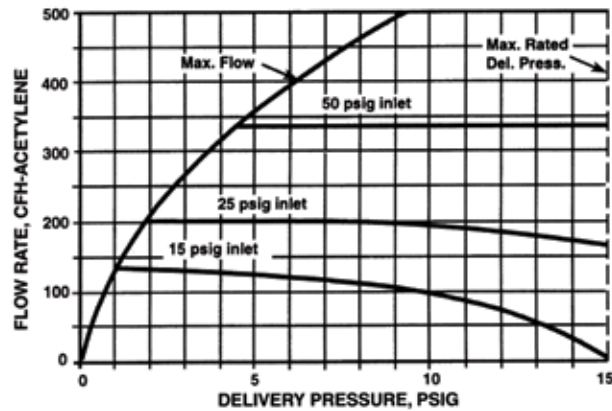

Figure 11 - R-720-15-510, -300



Ordering Information

Model	Part Number	CGA Outlet
Oxygen		
R-720-75-540	0558010647	022
R-720-125-540	0558010651	022
Acetylene		
R-720-15-510	0558010648	023
R-720-15-300	0558010649	023
Propylene or Propane		
R-720-75-510	0558010650	023
Inert		
R-720-75-580	0558010643	032
R-720-125-580	0558010644	032
R-36-500-580	0558010652	1/4 in., 37° flared
Carbon Dioxide		
R-720-75-320	0558010638	032

Cylinder Regulator/Flowmeter Combinations



R-760-CF-320 Carbon Dioxide

- Black anodized finned body for the best heat conduction possible
- Valve stem attached to diaphragm for positive shut off, especially when cold
- Low rate pressure adjusting spring for smooth and easy flow adjustment, coupled with a 2-1/2 in. (63.5 mm) delivery gauge scaled in cfh
- Carbon dioxide flow rates up to 80 cfh



R-5007-FM-580/R-5008-FM-320

- R-5007 for argon, helium, C-25 mixture, and nitrogen (R-5008 for carbon dioxide only)
- Accurate flow control of argon, helium, C-25, and nitrogen
- Delivery pressure to flowmeter factory-preset to 50 psig

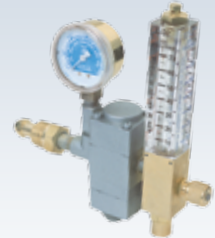

R-720-CF-580

- 2-1/2 in. (63.5 mm) delivery gauge scaled in cfh
- Accurate argon flow rate of 10-40 cfh



R-502-FM-580

- Two-stage version of R-5007
- Provides constant, accurate flow as cylinder pressure decreases

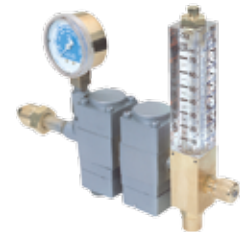

R-720-FM-580

- Mounted with the well-known L-32 type flowmeter
- Accurate flow control of argon, helium, C-25, and nitrogen
- Delivery pressure to flowmeter factory-preset to 50 psig



Gas Apparatus

Specifications & Ordering Information

Cylinder Gas	Model	Part Number	Calibrated Flow Range	CGA Outlet Connection
			cfh	
Carbon Dioxide	R-760-CF-320	999149	10-80	5/8-18 RH female
Inert Gas	R-720-CF-580	0558010645	10-40	5/8-18 RH female
	R-720-FM-580	0558010646	10-70 Argon 20-220 Helium 10-80 Nitrogen 10-65 C-25	5/8-18 RH female
Argon, Helium, C-25, and Nitrogen	R-5007-FM-580	998124	10-70 Argon 20-220 Helium 10-80 Nitrogen 10-65 C-25	5/8-18 RH female
	R-502-FM-580	998846		5/8-18 RH female
Carbon Dioxide	R-5008-FM-320	998125	10-65	5/8-18 RH female

Cylinder Regulator/Flowmeter Combinations



R-33 Regulator Flowmeter

- Durable Lexan outer tube and flow tube with easy-to-read graduations
- Solid brass piston and machined brass body
- 3,000 psi cylinder contents gauge

R-50 Series Regulator/Flowmeter Combinations

- Brass bar stock construction for long life and durability
- Equipped with cylinder contents gauge for convenience
- Equipped with reliable safety release system for operator and equipment protection



R-33-FM-580

Ordering Information

Regulator/Flowmeters

R-33-FM-580	21557
R-33-FM-580 Display Package ¹	21589
R-33-FM-320	21558
R-33-FM-320 Display Package ¹	21590
R-50-FM-580	17775

¹Consists of R-33-FM plus an 8 ft. (2.4 m) hose #21591.

Specifications

Regulator Model	Gas Service	Flow Rate	Connections (CGA) Outlet
		cfh	
R-33-FM-580 Display Package	Argon	10-50	5/8-18 RH female
	Helium	20-150	
	C-25	10-50	
R-33-FM-320 Display Package	Carbon Dioxide	10-65	5/8-18 RH female
R-50-FM-580	Argon	10-40	5/8-18 RH female
	Helium	20-125	
	Nitrogen	10-50	
	C-25	10-40	

Station Drop/Line Flowmeters



L-32/L-33 Flowmeters

- Durable Lexan outer tubes
- L-32 has four rotatable scales
- L-33 has single scale
- Carbon dioxide models available in both styles

Ordering Information

L-32	
Argon, Helium, C-25, and Nitrogen	639751
Carbon Dioxide.....	998843
L-33IG	
Argon	21988
L-33 Carbon Dioxide	
Carbon Dioxide.....	21990

Options & Accessories

Flowmeter Guard

Mounts over the calibrated tube of the L-32 for protection against rough handling 17459

Portable Gas Meter

Available to check actual shielding gas flow at torch. 19043



Gas meter



L-32



L-32 with guard



L-33

Gas Apparatus

Specifications

Gas	Model	Optimum Inlet Pressure	Calibrated Flow Range cfh	Connections (CGA)	
				Inlet	Outlet
Argon, Helium, C-25, and Nitrogen	L-32	50	10-70 Argon 10-65 C-25 20-220 Helium 10-80 Nitrogen	RH male ¹	5/8-18 RH female
Carbon Dioxide	L-32	80	10-65 Carbon Dioxide	1/4 NPT	5/8-18 RH female
Argon	L-33IG	25	10-50	5/8-18 RH male	5/8-18 RH female
Helium, C-25	L-33IG	25	20-150 Helium 10-50 C-25/Argon	1/4 NPT female	5/8-18 RH female
Carbon Dioxide	L-33 Carbon Dioxide	80	10-65	1/4 NPT female	5/8-18 RH female

¹Available in 1/4 in. NPT inlet #639749.
A L-32 20 psi model is available, #603383.

Station Drop/Line Regulators



R-760 OXWELD Elite Series Extra Heavy-Duty Station Regulators

- Similar in construction to single-stage, heavy-duty cylinder regulators, these regulators are equipped with a “C” size inlet connection
- Models are available for oxygen, acetylene, alternate fuels, and inert gases



Extra Heavy-Duty Hi-Flow R-760

R-720 PUROX Elite Series Medium/Heavy-Duty Station Regulators

- Similar in construction to single-stage, medium-duty cylinder regulators, these regulators are equipped with a “C” size inlet connection
- Models are available for oxygen, acetylene, alternate fuels, and inert gases



Medium/Heavy-Duty R-720

R-6700 OXWELD High-Capacity Station Regulators

- For multi-torch applications; for example, the supply of cutting oxygen to an eight-torch cutting machine working on heavy plate
- Three models are available with up to five times the capacity of standard models
- Equipped with 1/2 in. (13 mm) NPT female inlet/outlet connections, and a delivery pressure gauge capacity of standard models
- Can be used with any common, non-corrosive, industrial gas
- “C” size outlet fittings available for oxygen, fuel gases, and inert gas



High-Capacity R-6700

Station Drop/Line Regulators



Specifications & Ordering Information

Gas Service	Model	Part Number	Maximum Delivery Pressure	Maximum Inlet Pressure ¹	CGA Outlet Connections ²
			psig	psig	
R-760 Elite Series Extra Heavy-Duty Hi-Flow Station Regulators					
Oxygen	R-760-150-024	0558010654	150	200	022
Acetylene	R-760-15-025	0558010655	15	15	023
Natural Gas, Propane, Hydrogen, Propylene	R-760-75-025	0558010656	75	200	023
Argon, Helium, Nitrogen	R-760-150-034	0558010658	150	200	032
R-720 Elite Series Medium/Heavy-Duty Station Regulators					
Oxygen	R-720-75-024	0558010639	75	200	022
Acetylene	R-720-15-025	0558010640	15	15	023
Natural Gas, Propane, Hydrogen, Propylene	R-720-75-025	0558010641	75	200	023
Argon, Helium, Nitrogen	R-720-75-034	0558010642	75	200	032
R-6700 High-Capacity Station Regulators					
Any non-corrosive, non-toxic industrial gas except Carbon Dioxide	R-6701	22234	15	400	1/2 NPT female
	R-6702	22235	75	400	1/2 NPT female
	R-6703	22236	150	400	1/2 NPT female
	R-6704	2227920	200	400	1/2 NPT female

¹Inlet pressure is limited because pressure of pipeline with "C" size hose-type outlets should not exceed 200 psig. Inlet pressure on acetylene regulators is limited because pressure of pipelines conveying acetylene should never exceed 15 psig.

²Outlet Connection:

- CGA 022 (formerly "B" oxygen) - 9/16 in. - 18 RH male connection
- CGA 023 (formerly "B" fuel gas) - 9/16 in. - 18 LH male connection
- CGA 032 (formerly "B" inert gas) - 5/8 in. - 18 RH female connection

Inlet Connection:

- CGA 024 (formerly "C" oxygen) - 7/8 in. - 14 RH female nut
- CGA 025 (formerly "C" fuel gas) - 7/8 in. - 14 LH female nut
- CGA 034 (formerly "C" inert gas) - 7/8 in. - 14 RH male nut

Flow Rates: Refer to curves on pages 61 thru 62 for data on selected regulator flow rates. See instruction literature F-15-396 for flow rates on R-6700 series regulators.

Gas Apparatus

Replacement Gauges

Replacement Gauges for Regulators

- Easy-to-read dial markings
- Durable 1/4-turn Lexan crystals
- 6 o'clock nipple position for most convenient gauge reading
- Specially packaged for showroom display
- Plain white face models for use on regulators of any make

Replacement Windows

- 2-1/2 in. (63.5 mm), 1/4 turn twist-lock 18858
- 2 in. (51 mm), 1/4 turn twist-lock..... 18859
- 2 in. (51 mm), snap-in..... 18702

Gas Apparatus



4000 psig White, 2 in. (51 mm) #21868



4000 psig Green, 2 in. (51 mm) #22429



4000 psig Red, 2-1/2 in. (63.5 mm) #999444



4000 psig Blue, 2 in. (51 mm) #22441

Replacement Gauges



Specifications & Ordering Information

Diameter		Nipple		Scale, psig	Case	Shadess	Part Number
in.	mm	in.	mm				
2-1/2	63.5	1/4 -18 NPT	6.4-457 NPT	30	Brass	White (RB)	19076
					Brass	White	19134
					Brass	Blue	999505
					Brass	Red	999437
				100	Brass	White	19135
					Brass	Blue	999435
					Brass	Red	999434
					Brass	Green	999436
				200	Brass	White	19136
					Brass	Blue	999439
					Brass	Red	999438
					Brass	Green	999440
				400	Brass	White	19137
					Brass	Red	999441
					Brass	Green	999442
				1,000	Brass	White	19077
4,000	Brass	White	19138				
	Brass	Blue	999445				
	Brass	Red	999444				
	Brass	Green	999446				
2	51	1/4-18 NPT	6.4-457 NPT	30	Plastic	White (RB)	21934
					Steel	Red	999515
				100	Plastic	Red	22437
					Plastic	White	21935
					Steel	Blue	999992
					Plastic	Blue	22438
					Steel	Red	999993
					Steel	Green	999516
				200	Plastic	Green	22431
					Plastic	White	21936
					Plastic	Blue	22439
					Plastic	White	21937
				400	Steel	Red	999517
					Plastic	Red	22440
					Plastic	White	21939
				600	Plastic	Green	22430
					Plastic	Blue	22442
					Plastic	White	21938
					Steel	Blue	999518
					Plastic	Blue	22441
4,000	Steel	Green	999519				
	Plastic	Green	22429				
	Plastic	Blue	22443				
	60 cfh	Plastic	Blue	22443			
2	51	1/8-27 NPT	3.2-686 NPT	30	Plastic	White	21865
					Steel	Red	18694
				100	Plastic	White	21866
					Steel	Green	18696
				400	Plastic	White	21867
					Steel	Red	18695
				4,000	Plastic	White	21868
					Steel	Green	18697'

Gas Apparatus

³Dial shade refers to decorative background color: Red - fuel gas; Green - oxygen; White - for any gas that is not oil pumped. Gauge markings: "USE NO OIL." "RB" models are for acetylene. Blue - for any gas EXCEPT oxygen. Used on all inert gas regulators.

⁴Dial actually marked with fractional contents of acetylene cylinders (1/4, 1/2, 3/4, full).

Valves

Single & Double Shutoff Valves

- **V-26** - for quick-acting on/off control of oxygen
- **V-27** - used in flame-hardening, machine cutting, etc., for quick-acting on/off control of oxygen and fuel gas with a single lever
- **V-30** - used in electric welding for on/off control of argon and water
- **V-31** - used in oxy-fuel gas welding for control of stop/start operations; two models are available which vary only in pilot light assembly

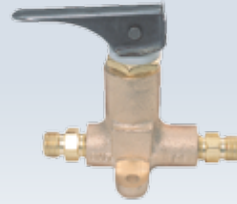

V-26

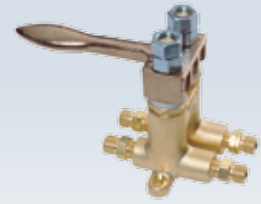

V-27



V-30

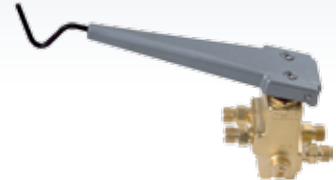

V-31

Ordering Information

- V-26 oxygen single shutoff valve 07X36
- V-27 oxygen-fuel gas shutoff valve 20X25
- V-31 oxygen-acetylene shutoff valve 16X22
- V-31 oxygen-fuel gas shutoff valve 22X18

Maximum Operating Pressures & Specifications

Description	V-26	V-27	V-30	V-31
Argon	-	-	100 psig (690 kPa)	-
Water	-	-	75 psig (517 kPa)	-
Oxygen	150 psig (1,035 kPa)	150 psig (1,035 kPa)	-	100 psig (690 kPa)
Acetylene	-	15 psig (103 kPa)	-	15 psig (103 kPa)
Other fuel gases	-	75 psig (517 kPa)	-	75 psig (517 kPa)
Height	5-3/4 in. (146 mm)	6-3/4 in. (172 mm)	5 in. (127 mm)	5 in. (127 mm)
Width	2-3/8 in. (60 mm)	3-5/8 in. (92 mm)	4 in. (102 mm)	4-1/2 in. (114 mm)
Length	5-1/2 in. (140 mm)	5-1/2 in. (140 mm)	10 in. (254 mm)	10 in. (254 mm)
Inlet & outlet connections	*	*	-	*

*The V-26, V-27, and V-31 valves are all supplied with appropriate 1/4 in. NPT to "B" size inlet and outlet connection fittings, packed loose.

Needle Valve Specifications

Valve Type	Part Number	Height		Length		Shipping Weight		Connections (CGA)	
		in.	mm	in.	mm	lbs.	kg	Inlet	Outlet
Oxygen Needle Valve "B" Size	3395	2	51	2-7/8	73	1/2	0.2	"B" RH female (9/16-18)	"B" RH male (9/16-18)
Acetylene Needle Valve "B" Size	3396	2	51	2-7/8	73	1/2	0.2	"B" LH female (9/16-18)	"B" LH male (9/16-18)



Adaptors



Hose connection adaptors have the following American Standards Association screw threads:

- **Hose Connection: "A" Size**
Screw Thread: 3/8 in. (9.5 mm) - 24 NF-3
- **Hose Connection: "B" Size**
Screw Thread: 9/16 in. (14 mm) - 18 NF-3
- **Hose Connection: "C" Size**
Screw Thread: 7/8 in. (22 mm) - 14 NF-3
- **Hose Connection: "D" Size**
Screw Thread: 1-1/4 in. (32 mm) - 12 NF-3



119X02



119X04



119X10



119X07

Cylinder to Regulator

Cylinder Connection	Regulator Connection	Adaptor Part Number
CGA 510 Acetylene (.885 in.-14 LH Internal)	CGA 300 Acetylene (alternate) (.830 in. - 14 Internal)	119X02
	CGA 520 Acetylene ("B"-Tanks) (.899 in. - 18 Internal)	119X04
CGA 520 Acetylene ("B"-Tanks) (.895 in.-18 RH External)	CGA 510 PREST-O-LITE Acetylene (.880 in. - 14 External)	119X10
	CGA 200 Acetylene ("MC" Tanks) (.628 in. - 20 Internal)	119X07

Pipe Thread to Regulator Connection

Pipe Thread	Regulator Connection	Adaptor Part Number
1/2 NPT	CGA 540	6425
1/2 NPT	CGA 555	6426
1/2 NPT	CGA 580 (female)	639059



6425/6426



639059

Multiple-Connection Adaptors

Description	From	To	Part Number
Oxygen (Y) Connection Adaptor	"B" Size Oxygen female	Two "B" Size Oxygen male	3798
Acetylene (Y) Connection Adaptor	"B" Size Acetylene female	Two "B" Size Acetylene male	3799
Inert Gas Connection Adaptor	"B" Size Inert Internal	Two "B" Size Inert External	950356



3798

Gas Apparatus

Adaptors

Pipe Thread to Hose Connection

Pipe Thread	Regulator Connection	Adaptor Part Number
1/4 NPT (5/8-18 External)	"B" Inert Gas	74S76
1/4 NPT (5/8-18 External RH)	Air/Water (old style)	10Z30
1/4 NPT (5/8-18 Internal LH)	Air/Water (CGA Standard)	11N16
1/2 NPT	"B" Oxygen	8696
1/2 NPT	"B" Fuel Gas	8693
1/2 NPT	"C" Oxygen	18Z55
1/2 NPT	"C" Fuel Gas	18Z08
1/2 NPT	"C" Inert Gas	639377
3/4 NPT	"C" Fuel Gas	18Z04
3/4 NPT	"D" Oxygen	73A68
3/4 NPT	"D" Fuel Gas	18Z50



74S76

Hose Connection to Hose Connection (Straight)

From	To	Part Number
"B" Oxygen male	"B" Argon male	11N21
"B" Oxygen External	"A" Oxygen Internal	6998
"B" Fuel Gas External	"A" Fuel Gas Internal	6999
"C" Oxygen External	"B" Oxygen Internal	18X19 ¹
"C" Fuel Gas External	"B" Fuel Gas Internal	18X29 ¹

¹With swivel "C" size nut.



6998/6999

Hose Connection to Hose Connection (90°)

From	To	Part Number
"B" Oxygen Internal	"B" Oxygen External	18X55
"B" Fuel Gas Internal	"B" Fuel Gas External	18X56
Standard Air/Water 5/8 - 18 NF-2 male	Standard Air/Water 5/8 - 18 NF-2 female	19X19



18X55/18X56

Steel Industry Products



Quality. Experience. Service. The Most Complete Product Line.

When it comes to exceeding your expectations for steel industry products, only one company does it all - ESAB!

Top Quality

If you want the best quality, reliability, and safety, count on ESAB. With some of the industry's most well-known and widely trusted names, such as OXWELD®, you never have to worry that your equipment is second best.

Unsurpassed Experience

We've been leading the steel industry products market for more than 85 years. Our advanced research, development, and design capabilities, along with continuous monitoring of consumer demands, have kept us at the forefront and allowed us to meet your changing needs.

Superior Service

At ESAB, we do much more than supply your products. Our staff of sales and engineering professionals can help make your job easier, faster, and more economical. We understand the unique and challenging demands of steel production, and we provide solutions. We help you select the right equipment for compliance with OSHA requirements.



Steel Industry Products

Product Offering Guide

Torches & Tips

Hand

Cutting & Scarfing

C-59

1808 cutting tips
1806 scarfing tips

Cutting

C-66-1400

1427 tips



C-66

PM-GST

PM tips

C-63

1808 tips

Oxygen Lance

Mechanized

C-67-1400

1427 tips
1431 high speed tips

C-43-E

1427 tips
1431 high speed tips

PM-100, PM-200, PM-300

PM tips



PM-100

C-60

1701, 1702, tips

C-100

C-100 tips

Powder Cutting Equipment

Torches, tips, adaptors, hoppers

Regulation Devices

High Pressure Cylinder

R-89

High Capacity Manifold

R-2327

R-2428

High Capacity Industrial

R-52 family



R-52

Panels

Station Drops

Flashback/Backflow Protection Devices

Dry type

Filters and Valves

Hand Scarfing/Cutting Torches

Steel Industry Products



C-59 Scarfing/Cutting Torch

- Scarfing widths from 2-1/2-3-3/16 in. (63.5-81 mm)
- Cuts 20-60 in. (508-1524 mm)
- Alternate fuels
- High capacity emergency hand cutting
- Uses 1800 series cutting tips
- C-59 available with or without rod feed, which improves starts

Ordering Information

Model	Length		Degree	Part Number
	in.	m		
C-59-36-75	36	0.9	75	02X67
C-59-48-75	48	1.2	75	02X68
C-59-48-75NRF	48	1.2	75	02X92
C-59-48-180NRF	48	1.2	180	5278749
C-59-56-75NRF	56	1.4	75	526438
C-59-72-75	72	1.8	75	5278595
C-59-72-180NRF	72	1.8	180	5278980
C-59-84-180NRF	84	2.1	180	5278667
C-59-108-75NRF	108	2.7	75	5278890
C-59-108-90NRF	108	2.7	90	2217963
C-59-108-180NRF	108	2.7	180	5279250
C-59-120-75NRF	120	3.0	75	2217964
C-59-120-90NRF	120	3.0	90	2217965
C-59-120-180NRF	120	3.0	180	2119320
C-59-144-90NRF	144	3.7	90	2217967
C-59-144-180NRF	144	3.7	180	2217968

Note: NRF = No rod feed.

Specifications

Model	Cutting Range		Scarfing Range		Tip Series
	in.	mm	in.	mm	
C-59	20-60	508-1524	2-1/2-3-3/16	63.5-81	1800



C-59 NRF

Gas Apparatus

Options & Accessories

Riding Skid Assembly

C-59..... 5279716

Replacement Heads, C-59

75° 83Z97
 90° 2117835
 180° 83Z92

Hose Requirements

Oxygen 1/2 in. (13 mm), "C" Size
 Fuel gas 3/8 in. (9.5 mm), "B" Size

Hand Cutting Torches

Steel Industry Products



OXWELD C-63

- Cutting range 9-60 in. (229-1524 mm)
- Alternate fuels
- Separate preheat and cutting oxygen inlets
- Off-center 180° head allows kerf to be widened by rotating torch; torch can then be inserted into kerf to deepen cut
- Use 1808 series cutting tips



C-66-1400 Series

- Cutting range 3-28 in. (76-711 mm)
- Alternate fuels
- Reliable emergency hand cutting in production mill environments
- Designed for extra heavy-duty operations for long trouble-free service life
- Torch lengths from 2.5-17 ft. (0.8-5 m)
- Torches 9 ft. (2.7 m) and over have protective out channel
- Off-center 180° head allows kerf to be widened by rotating torch; torch can then be inserted into kerf to deepen cut
- Use 1400 series cutting tips
- Fast, efficient scrap cutting

OXWELD PM-GST¹

- Cutting range 3-16 in. (76-406 mm)
- Alternate fuels
- Reliable emergency hand cutting production mill environments
- Designed for extra heavy-duty operations for long trouble-free service life
- Superior emergency torch capability
- High stand-off 4-6 in. (102-152 mm)
- Pilot flame modes saves gas in stand-by mode, ready for immediate use
- Use standard PM-100/PM-200 cutting tips
- This torch cannot pierce plate
- Post mix design prevents flashbacks

¹PM-GST = post mix-gas saving torch.

Ordering Information

Model	Length		Degree	Part Number
	in.	m		
C-66-1400	48	1.2	75	718321
	48	1.2	90	2120361
	48	1.2	180	718322
	60	1.5	75	718323
	60	1.5	90	22122
	60	1.5	180	718324
	72	1.8	75	718325
	72	1.8	90	22123
	72	1.8	180	718326
C-63	60	1.5	180	27X05
	60	1.5	75	5279010
	72	1.8	180	2219219
	84	2.1	75	5279856
PM-GST	60	1.5	75	22087
	60	1.5	90	22095
	60	1.5	180	22099
	72	1.8	90	22096
	96	2.4	90	22097

Hose Requirements

C-66-1400 & PM-GST

Oxygen "C" size; Fuel "B" size

C-63

Preheat "B" size

Cut oxygen 1/2 in. (13 mm), "C" size

Riding Skid Assembly

C-66-1400 2029858

C-63 5279716

PM-GST 22073

Machine Cutting Torches

Steel Industry Products



OXWELD C-67-1400

- Cut steel up to 30 in. (762 mm) thick
- Low- and medium-pressure alternate fuels
- Three hose connections - separate cutting oxygen
- Straight line, shape, or scrap cutting
- Use high performance 1400 series cutting tips
- Mounts in standard torch holders

OXWELD C-43E

- Cut steel up to 30 in. (762 mm) thick
- Medium-pressure alternate fuels
- Water-cooled
- Three hose connections
- Straight line, shape, or scrap cutting
- Use high performance 1400 series cutting tips

OXWELD PM-100, PM-200 & PM-300

- Cutting range with alternate fuels:
 - PM-100: 16 in. (406 mm)
 - PM-200: 24 in. (610 mm)
 - PM-300: 40 in. (1016 mm)
- Gases mixed outside torch - safe, trouble-free operation
- Convection, air, or water-cooled
- Automatic cut-off or shape cutting operations
- High stand-off keeps high-speed cutting tips clean
- PM-100 has 1-3/8 in. (35 mm) barrel, PM-200 and PM-300 have 2 in. (51 mm) barrel
- Post-mix design does not permit piercing of plate

OXWELD C-60

- Cut steel 25-60 in. (635-1524 mm)
- Medium-pressure alternate fuels including acetylene
- Short and long versions available with or without tube and rack assembly
- Use 1701 and 1702 series cutting tips

OXWELD C-100

- Cut steel 40-96 in. (1016-2438 mm)
- Medium-pressure alternate fuels
- Special ball seat cutting tips

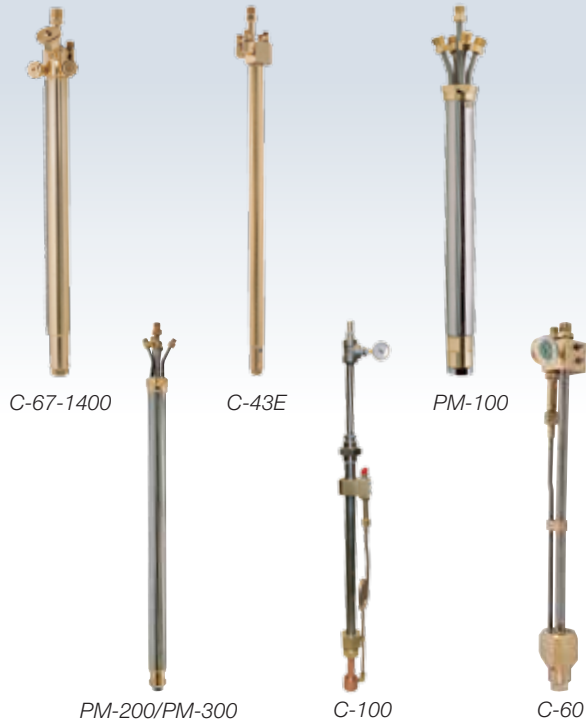

C-67-1400

C-43E

PM-100

PM-200/PM-300

C-100

C-60

Ordering Information

Model	Part Number
C-67-1400-20	644644
C-67-1400-12	2217997
C-43E-01 in-line connection	20826
PM-100-01 (139/16 in.)	2118100
PM-200-01 (18 in.)	2222658
PM-200-03 (331/2 in.)	2218800
PM-300 (331/2 in.)	2228300
C-60-02 (7 ft. without rack and tube)	687541
C-100-01 (9 ft. without tip)	691442
C-100-04 (51/2 ft. with #100 tip)	2028139

Hose Requirements

C-67-1400, C-43E, and PM-100

3/8 in. (9.5 mm) "B" size

PM-200

3/8 in. (9.5 mm) "B" preheat oxygen and fuel,
Cutting oxygen - 1/2 in. (13 mm) "C" size

C-60 and C-100

Preheat 1/2 in. (13 mm) "C" size
Cutting oxygen - 3/4 in. (19 mm) "D" size

PM-300

3/8 in. (9.5 mm) "B" preheat oxygen and fuel,
Cutting oxygen - 3/4 in. (19 mm) "D" size

OXWELD® Lance

Steel Industry Products



V-24 Oxygen Lance

- Reliable lancing for steel mill, foundry, production, and scrapping applications
- Lever-operated valve for dependable ease-on and quick shut-off of oxygen
- Quick connect pipe chuck grips pipe firmly
- Neoprene seals prevent leakage around lance pipe
- Compact and durable
- Uses schedule 40 black iron pipe



V-24

Gas Apparatus

Ordering Information

Model	Part Number
	"C" Size Connections
V-24 Oxygen Lance Valve Only	06X78
V-24 Oxygen Lance Valve 1/4 in. (6.4 mm) Holder	9728A65
V-24 Oxygen Lance Valve 3/8 in. (9.5 mm) Holder	9728B65
V-24 Oxygen Lance Valve 1/2 in. (13 mm) Holder	9728C65

Hose Requirements

"C" size (CGA-024) 1/2 in. (13 mm)

Nominal Oxygen Flow (cfh) Through 10 ft. (3 m) Schedule 40 Pipe

Inlet Pressure	Pipe Size (with no internal obstructions)			
	1/8 in. (3.2 mm)	1/4 in. (6.4 mm)	3/8 in. (9.5 mm)	1/2 in. (13 mm)
40 psig	1,200	2,350	2,800	8,500
60	1,700	3,400	5,800	11,000
80	2,200	4,450	7,900	13,500
100	2,700	5,500	10,000	16,000

Maximum operating pressure - 100 psig.

OXWELD® Cutting Tips

Steel Industry Products



1400 Series Alternate Fuels

Model	Steel Thickness		Size	One-Piece or Internal Part Number
	in.	mm		
Fits C-43, 66 and 67-1400 Torches	12	305	1427-12	5470099
	14	356	1427-14	5470144
	16	406	1427-16	5470100
	20	508	1427-20	5460192
	24	610	1427-24	5460162
	28	711	1427-28	5460193
	3-6	76-152	1431-120	66Z59
	6-10	152-254	1431-140	66Z60
	10-16	254-406	1431-160	66Z61
	16-20	406-508	1431-200	66Z62
	20-24	508-610	1431-240	66Z63
	24-28	610-711	1431-280	66Z64



1427 & 1431

1427 Series Alternate Fuels Operating Data

Tip			Steel Thickness			Gas Pressure			Cutting Speed		Cleaning Drill Size		Gas Consumption		
Size		Part Number	in.	mm	Cutting Oxygen	Preheat Oxygen	Natural Gas	ipm	mm/min	Preheat	Cutting	Cutting Oxygen	Preheat Oxygen	Natural Gas	
in.	mm														psig
12	305	5470099	12	305	75-85	8-10	16-19	4-5	102-127	55	31	800-900	100-115	65-75	
14	356	5470144	14	356	60-70	7-9	8-11	3-1/2-4-1/2	89-114	54	28	950-1,100	115-140	75-95	
16	406	5470100	16	406	55-65	9-12	11-15	3-4-1/2	76-114	53	20	1,150-1,330	145-175	95-115	
20	508	5460192	20	508	45-55	13-18	17-23	2-1/4	57	52	8	1,450-1,700	170-225	125-150	
24	610	5460162	24	610	40-50	21-25	28-33	2-3-1/2	51-89	51	C	1,850-2,200	225-285	170-190	
28	711	5460193	28	711	30-40	28-33	39-45	2-3-1/2	51-89	50	K	1,950-2,400	315-350	210-235	

1427 Series Tips: Cutting speeds are based on cutting steel at room temperature and have straight cylindrical cutting bores.

1431 High Speed Series Alternate Fuels Operating Data

Tip			Steel Thickness			Gas Pressure			Cutting Speed		Cleaning Drill Size		Gas Consumption		
Size		Part Number	in.	mm	Cutting Oxygen	Preheat Oxygen	Natural Gas	ipm	mm/min	Preheat	Cutting	Cutting Oxygen	Preheat Oxygen	Natural Gas	
in.	m														psig
140	3.5	66Z60	6-10	152-254	80-115	10	13	10-20	254-508	54	28	1,850	225	130	
160	4.0	66Z61	10-16	254-406	80-115	11	14	10-20	254-508	53	20	2,100	240	135	
200	5.0	66Z62	16-20	406-508	80-115	15	20	8-20	203-508	52	8	3,100	275	175	
240	6.0	66Z63	20-24	508-610	80-115	22	30	6-17	152-432	51	C	4,700	335	225	
280	7.1	66Z64	24-28	610-711	60-80	30	42	4-16	102-406	50	K	4,900	405	275	

1431 Series Tips: Cutting speeds are based on cutting steel at temperatures over 1,000°F (1,832°C), and have tapered divergent cutting bores. These tips are used in continuous casting cut-off or plate ripping applications where it is necessary to slice through quickly.

Given pressures are torch inlet pressures, not what to set regulator at; hose length, diameter, flash arrestor use, and many other factors affect pressure. Use test gauge adaptors to check pressure at back of torch.

Gas Apparatus

OXWELD® Cutting Tips

Steel Industry Products



1702 Series Alternate Fuels

Model	Steel Thickness		Size	One-Piece or Internal Part Number
	in.	m		
Fits C-60 Torch	35-40	0.9-1.0	1702-50	5470081
	45-50	1.1-1.3	1702-60	5470082
	50-60	1.3-1.5	1702-70	5490062

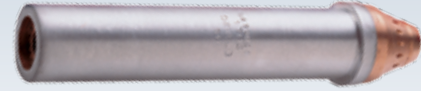

1702

1702 Series Natural Gas Operating Data

Tip			Steel Thickness		Gas Pressure			Cutting Speed		Cleaning Drill Size			Cleaning Drill Size			
Size		Part Number	Steel Thickness		Cutting Oxygen ¹	Natural Gas	Preheat Oxygen	Cutting Speed		Cutting Oxygen	Natural Gas	Preheat Oxygen ²	Cutting		Preheat	
in.	m		in.	m				psig	psig				psig	ipm	mm/min	in.
50	1.3	5470081	35-40	0.9	12	12-17	20-26	3	76	4600	380-450	570-675	1/2	13	46	1.2
60	1.5	5470082	45-50	1.1-1.3	7	14-18	25-30	2-2-1/2	51-63.5	5450	450-525	675-790	19/32	15	45	1.1
70	1.8	5490062	50-60	1.3-1.5	6	16-24	30-40	2-1-1/4	51-32	7500	525-650	790-975	11/16	17.5	43	1.1

¹Read from gauge mounted on torch.

²Preheat oxygen flow is given as 50% of natural gas flow for a 1.5 oxygen to 1.0 natural gas ratio. This oxygen/natural gas ratio produces a long inner cone flame length which is used for most heavy cutting operations.

Given pressures are torch inlet pressures, not what to set regulator at; hose length, diameter, flash arrestor use, and many other factors affect pressure. Use test gauge adaptors to check pressure at back of torch.

OXWELD® Cutting Tips

Steel Industry Products



1808 Series Alternate Fuels

Model	Steel Thickness		Size	One-Piece or Internal Part Number
	in.	m		
Fits C-59 and C-63	20-40	0.5-1.0	1808-30	65Z44
	40-50	1.0-1.3	1808-40	65Z45
	50-60	1.3-1.5	1808-50	65Z46



1808

Tip Data

Size	Part Number	Cleaning Drill Size			
		Cutting		Preheat	
		in.	mm	in.	m
30	65Z44	19/64	7.5	51	1.3
40	65Z45	2/5	10	50	1.3
50	65Z46	1/2	13	48	1.2

Oxy-Propane Operating Data

Metal Thickness		Tip Number	Cutting Oxygen		Propane		Preheat Oxygen	
in.	m		psig	cfh	psig	cfh	psig	cfh
20-40	0.5-1.0	30	50	4,500	12-14	132	45	462
40-50	1.0-1.3	40	50	7,000	13-15	144	50	504
over 50	over 1.3	50	50	9,000	13-15	150	55	525

Gas Apparatus

Oxy-Natural Gas Operating Data

Metal Thickness		Tip Number	Cutting Oxygen		Natural Gas		Preheat Oxygen	
in.	m		psig	cfh	psig	cfh	psig	cfh
20-40	0.5-1.0	30	50	4,500	21-23	330	68	660
40-50	1.0-1.3	40	50	7,000	23-25	360	75	720
over 50	over 1.3	50	50	9,000	24-26	375	78	750

Given pressures are torch inlet pressures, not what to set regulator at; hose length, diameter, flash arrestor use, and many other factors affect pressure. Use test gauge adaptors to check pressure at back of torch.

OXWELD® Cutting Tips

Steel Industry Products



PM Tips Alternate Fuels

Model	Steel Thickness		Size	One-Piece or Internal Part Number
	in.	mm		
Fits PM-100, 200, and GST Torches	3-6	76-152	PM-120-85	2118702
	6-10	152-254	PM-140-85	2118701
	6-10	152-254	PM-110-200	2118707
	10-16	254-406	PM-160-85	2118700
	10-24	406-610	PM-160-135	2118703
	4-9	102-229	PM-93-200	2228620



PM-100, 200, and GST

PM - GST Operating Data

Tip Part Number	Steel Thickness		Gas Pressure		Tip Stand-off		Gas Consumption	
			Cutting Oxygen ¹	Natural Gas or Propane			Oxygen	Natural Gas or Propane
	in.	mm	psig	psig	in.	mm	cfh	cfh
2118700	10-16	254-406	80-110	10-30	4-6	102-152	2080	225-500
2118701	6-10	152-254	80-110	10-30	4-6	102-152	1640	225-500
2118702	3-6	76-152	80-110	10-30	4-6	102-152	1260	225-500

PM-100/PM-200/PM-300 Operating Data

Tip Part Number	Steel Thickness		Gas Pressure			Cutting Speed		Tip Stand-off		Gas Consumption		
			Cutting Oxygen	Preheat Oxygen	Natural Gas					Cutting Oxygen	Natural Gas	Preheat Oxygen
	in.	mm	psig	psig	psig	ipm	mm/min	in.	mm	cfh	cfh	cfh
PM-100/200												
2118700	10-20	406-508	85	10-20	4-6	6-9	152-229	4-6	102-152	1800	180-240	345-465
2118701	6-10	152-254	85	10-20	4-6	9-13	229-330	4-6	102-152	1400	180-240	345-465
2118702	3-6	76-152	85	10-20	4-6	12-18	305-457	4-6	102-152	1020	180-240	345-465
2118703	20-30	508-762	135	10-20	4-6	2-10	51-254	4-6	102-152	3040	180-240	345-465
2118707	6-10	152-254	190	10-20	4-6	7-16	178-406	4-6	102-152	2020	180-240	345-465
PM-300												
2228185	20-30	508-762	80	10-20	4-6	3-6	76-152	5-7	127-178	3800	180-240	345-465
2228186	30-40	762-1016	135	10-20	4-6	2-4	51-102	5-7	127-178	5200	180-240	345-465

Oxygen pressure: Set while cutting lever is depressed; pressure measured at the torch.

Natural gas or propane pressure: Set while cutting lever is depressed and fuel gas valve is wide open; pressure measured at the torch.

Given pressures are torch inlet pressures, not what to set regulator at; hose length, diameter, flash arrestor use, and many other factors affect pressure. Use test gauge adaptors to check pressure at back of torch.

OXWELD® Scarfing & Cutting Tips

Steel Industry Products



C-100 Tips Alternate Fuels

Model	Steel Thickness		Size	One-Piece or Internal Part Number
	in.	m		
C-100	60-76	1.5-1.9	C-100-80	691446
	76-96	1.9-2.4	C-100-100	691448



C-100 #80

Operating Data

Tip Size	Part Number	Steel Thickness		Cutting Oxygen		Propane		Preheat Oxygen	
		in.	m	Pressure	Flow	Pressure	Flow	Pressure	Flow
				psig	cfh	psig	cfh	psig	cfh
80	691446	60-76	1.5-1.9	5-6	9,500-12,000	35	825	15	550
100	691448	76-96	1.9-2.4	5-7	15,000-19,000	35	825	15	550

1806 Series Alternate Fuels

Model	Steel Thickness (Scarf width)		Size	One-Piece or Internal Part Number
	in.	mm		
Fits C-59	2-1/4 - 3-3/16	57-81	1806-62	15X44



1806

Gas Apparatus

Tip Data

Tip		Scarfing Path Width		Preheat Holes	Cleaning Drill Size				Replacement Parts	
Size	Part Number	ipm	mm/min		Preheat		Cutting		Wear Ring Assembly	Tip Nut
					in.	mm	in.	mm		
62	15X44	2-1/4 - 3-3/16	57-81	16	1/16	1.6	5/8	16	60Y92	37Z23

Operating Data

Cutting Oxygen				Natural Gas			
Inlet Pressure		Flow		Inlet Pressure		Flow	
psig (bars)		cfh (m ³ /hr)		psig (bars)		cfh (m ³ /hr)	
20 (1.38)		4,300 (121)		5 (0.35)		40 (1.13)	
30 (2.07)		5,600 (159)		10 (0.69)		75 (2.12)	
40 (2.76)		7,000 (198)		15 (1.04)		105 (2.97)	
50 (3.45)		8,300 (235)		20 (1.38)		130 (3.68)	
60 (4.14)		9,600 (272)		-		-	

Hose Sizes: For oxygen, use "C" size hose (1/2 in. I.D.), Part Number 2120399 (50 ft.).
For fuel gas, "B" size hoses (3/8 in. I.D.), Part Number 2120404.

Given pressures are torch inlet pressures, not what to set regulator at; hose length, diameter, flash arrestor use, and many other factors affect pressure. Use test gauge adaptors to check pressure at back of torch.

Powder Equipment Steel Industry Products



- Rapidly cut any thickness stainless steel, cast iron, and high alloy steels
- As simple to use as regular cutting torches
- Manual or mechanized versions available

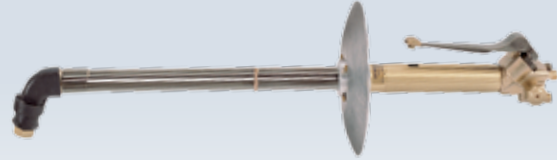

AC-4 torch

AC-4 Powder Cutting Hand Torches

- Capacity 10 in. (254 mm) thick stainless steel
- Acetylene or alternate fuels
- Single lever control
- Self contained

Powder Attachments for Standard OXWELD Torches

- Single- and Dual-Tube for straight-line cutting
- Multi-Jet for shape cutting applications
- See next page for details

Specifications & Ordering Information

Model	Part Number	Length		Head degree	Ship Weight		Inlet Connections, "B" Size	
		in.	mm		lbs.	kg	in.	mm
AC-4-28-75	02X60	28	711	75	22	10	3/8	9.5
AC-4-44-75	28X65	44	1118	75	30	14	3/8	9.5
AC-4-28-180	220234	28	711	180	22	10	3/8	9.5
AC-4-44-180	2117245	44	1118	180	30	14	3/8	9.5



AC-4 tip

AC-4 Powder Cutting Tips

- Powder flows between sleeve and tip
- Made from pure copper - rapid heat transfer
- Chrome plated powder flow surfaces for protection from wear

Specifications & Ordering Information

Gas Service	Description	Steel Thickness, max.		Size	Part Number	External Sleeve
		in.	mm			
Acetylene	1418-8	3	76	8	65Z02	71Z78
	1418-14	9	229	14	65Z05	71Z78
Alternate Fuels	1430-10	5	127	10	66Z33	71Z78
	1430-16	8	203	16	66Z34	71Z78
	1430-20	10	254	20	66Z35	71Z78

AC-4 Cutting Tip Data (For Clean 18-8 Stainless Steel) - 1418 & 1430 Series

Model Number	Part Number	Cutting Thickness, max.		Tip Size	Total Oxygen		Powder Flow		Acetylene		Natural Gas	
					Pressure	Flow			Pressure	Flow	Pressure	Flow
		psig	cfh		psig	cfh	psig	cfh				
1418-8	65Z02	3	76	8	50	370	19	9	2-8	19	-	-
1418-14	65Z05	9	229	14	80	1,300	30	14	2-8	57	-	-
1430-10	66Z33	5	127	10	80	780	20	9	-	-	5	40
1430-16	66Z34	8	203	16	100	2,120	30	14	-	-	15	85
1430-20	66Z35	10	254	20	100	2,960	32	14.5	-	-	20	105

Powder Equipment

Steel Industry Products



Powder Dispensers

- Heavy welded steel construction
- Hinged lid with heavy-duty closures
- Inlet gas filter and moisture trap
- Pop-off safety valve
- Screen filter sifts out lumps of powder
- Manual and automatic models

Manual Powder Dispensers

- Manual 100 and 400 lbs. (45 and 181.5 kg) dispensers designed for general powder cutting or lancing operations

Automatic Powder Dispenser

- Automatic 400 lbs. (181.5 kg) powder dispenser designed for automatic or semi-automatic machine cutting
- Equipped with electric powder valve and nitrogen gas purging
- Controlled by interfacing the cutting machines logic with the dispenser powder and gas controls



Powder dispenser - 100 lbs. (45 kg)

Options & Accessories

High Precision Cutting Ejector

For fine control and maximum economy when cutting materials less than 2 in. (51 mm) thick 65Z49

Powder Supply Hose

Fitted clear vinyl hose, 50 ft. (15 m) long..... 2119297

Inlet Nitrogen Hose

Fitted black rubber hose, 110 ft. (33.5 m) long.. 2211347

Cover Gaskets

100 lbs. (45 kg) dispenser 5279191

400 lbs. (181.5 kg) dispenser 2225204

Gas Apparatus

Specifications & Ordering Information

Powder Capacity		Part Number	Type	Powder Flow		Nitrogen Inlet	Nitrogen Flow	Operating Pressure	Relief Pressure
lbs.	kg			lbs/hr	kg/hr				
100	45	2217290	Manual	15-100	7-45	40	50-200	5-40	45
400	181.5	2223093	Manual	15-100	7-45	40	50-200	5-40	45
400	181.5	2220388	Automatic	15-100	7-45	40	50-200	5-40	45

Powder Attachment Ordering Information

Torch Type	Type Attachment	Part Number	Accessory Powder Valve
C-37, C-39, C-67 (mechanized) and other 1500 Series models	Single-Tube	60Y98	not required
PM-200 (mechanized)	Dual-Tube	2227380	
C-100 (mechanized)			2028213
C-31, C-32, C-66 (manual with 75° head)	Multi-Jet [†]	61Y59 (1500-ACA-2) 61Y60 (1500-ACA-1)	not required
C-31, C-32, C-66 (manual with 90° head)	Multi-Jet [†]	61Y61 (1500-ACA-2) 61Y58 (1500-ACA-1)	
C-37, C-39, C-67 (mechanized)	Multi-Jet [†]	61Y56 (1500-ACA-2)	

[†]Select the correct model based on the type tip being used. The 1500-ACA-2 attachment is limited to one-piece tips having a tapered front end as follows: 1514 Series through size 4, 1563 Series through size 6, 1564 Series, 1565 Series through size 3. The 1500-ACA-1 attachment accepts all other 1500 Series Cutting Tips.

Regulators

Steel Industry Products



High Pressure Regulators

- Typical applications include cartridge filling, pressure testing of vessels, and pressurization of recoil cylinders
- For high delivery pressures - 200-4,000 psig (1,380-27,600 kPa)
- Standard HP cylinder connections - ready to use on cylinders or manifolds
- Standard 1/4 in. NPT-37° flared tubing outlet connection on R-89 models
- Forged brass bodies
- Models available for higher inlet pressure inert gas cylinders



R-89-4M

Specifications & Ordering Information

Cylinder Gas	Model	Part Number	Maximum Delivery Pressure		CGA Connections		Pressure Gauges	
			psig	kPa	Inlet	Outlet	Inlet	Outlet
High-Pressure Regulators								
Inert Gases	R-89-3M-580	103X85	3,000	13,800	580	flare	4,000	4,000
	R-89-4M-680	19017	4,000	13,800	680	flare	6,000	6,000

Gas Apparatus

High Capacity Industrial Gas Regulators

- Pilot operation controls delivery pressure within 3% of maximum rated pressure if operated at more than 10% capacity
- High flow capacity up to 200,000 cfh for mill, foundry, and other industrial applications requiring consistent process control
- Where demand exceeds flow of a single regulator, multiple units can be installed in parallel



R-52

Specifications & Ordering Information

Gas Service	Model	Part Number	Maximum Inlet Pressure	Maximum Delivery Pressure	Inlet and Outlet Connection		Rated Capacity
			psig	psig	in.	mm	cfh
Oxygen	R-52	20A16	350	150	3/4 NPT	19 NPT	10,000
Oxygen	R-52-200	2117105	350	200	3/4 NPT	19 NPT	10,000
Oxygen	R-83	2103822	350	150	2 NPT	51 NPT	40,000
Acetylene	R-5210	524193	15	12	3/4 NPT	19 NPT	2,000
Fuel Gas	R-99	04X50	350	40	3/4 NPT	19 NPT	3,000
Fuel Gas	R-84	2103957	150	40	3/4 NPT	19 NPT	8,000

In most instances, capacity is much higher than listed. This will depend upon outlet pipe/hose restrictions. Consult ESAB for recommendations.

Regulation Panels

Steel Industry Products



Regulation Panels

- Meets OSHA requirements for piping safety
- Two and three outlet versions
- Portable or permanent process gas distribution
- Include all valves, safety devices, and filter for reliable long life
- Standard-Flow and High-Flow versions

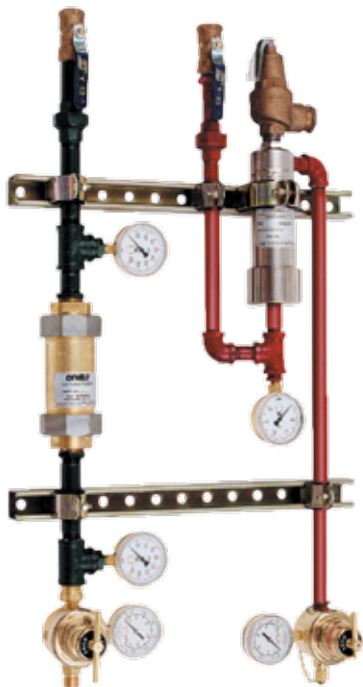

2-Hose Standard-Flow Panel



3-Hose High-Flow Panel

Gas Apparatus

Specifications & Ordering Information

Model	Part Number	Cut Oxy Regulator	P.H. Oxy Regulator	P.H. Fuel Regulator	Inlet Connections		Outlet Connections	
					Oxy	Fuel	Cut Oxy	P.H. Oxy and Fuel
Standard-Flow								
Two Outlet	2224539	R-6703	-	R-6702	3/4 NPT	1/2 NPT	"C" Size	"B" Size
Three Outlet	2224540	R-6703	R-6702	R-6702	3/4 NPT	1/2 NPT	"C" Size	"B" Size
Standard-Flow Without Filter								
Two Outlet	2225202	R-6703	-	R-6702	3/4 NPT	1/2 NPT	"C" Size	"B" Size
High-Flow								
Two Outlet	2119101	R-52-200	-	R-6702	3/4 NPT	1/2 NPT	"C" Size	"B" Size
Three Outlet	2116395	R-52-200	R-6702	R-6702	3/4 NPT	1/2 NPT	"C" Size	"B" Size

Station Drops

Steel Industry Products



Regulation Supply Lines

Standard-Flow Oxygen

- 1 in. (25 mm) oxygen filter (50 micron)
- Shutoff valve
- Check valve
- Meets OSHA requirements

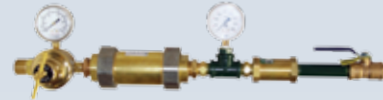

Standard-Flow Oxygen Station Drop



High-Flow Oxygen Station Drop

High-Flow Oxygen

- 1 in. (24 mm) oxygen filter (50 micron)
- Shutoff valve
- Check valve
- Meets OSHA requirements



Fuel Gas Station Drop

Fuel Gas

- 1 in. (24 fuel gas filter (50 micron)
- Shutoff valve
- H-16 back pressure valve and check valve
- Meets OSHA requirements



Argon Station Drop

Argon

- Shutoff valve

Air/Nitrogen

- Air line filter (40 micron)
- Shutoff valve



Air/Nitrogen Station Drop

Specifications & Ordering Information

Model	Part Number	Regulator	Inlet Connections	Outlet Connections
Standard-Flow Oxygen Station Drop	0558006001	R-6703	3/4 NPT	"D" Size
High-Flow Oxygen Station Drop	0558006000	R-52-200	3/4 NPT	"D" Size
Fuel Gas Station Drop	0558006002	R-6702	1/2 NPT	"C" Size
Argon Station Drop	0558006004	R-6703	1/2 NPT	"B" Size
Air/Nitrogen Station Drop	0558006003	R-6703	1/2 NPT	"C" Size

Flashback/Backflow Protective Devices

Steel Industry Products



H-14 & H-16 Dry Type Protective Devices

- Rated fuel gas capacities to 300 cfh
- Meets OSHA requirements and NFPA standards
- No liquid - requires no filling or cold weather maintenance
- Heavy-duty steel shell construction
- Models for all fuel gases
- Ideal for station service or portable outlet headers
- Flashback and backflow protection to satisfy OSHA regulations
- Contains relief valve



H-14

Specifications & Ordering Information

Gas Service	Model	Part Number	Maximum Inlet Pressure	Rated Flow Capacity	Pressure Drop at 300	Height		Max Diameter		Inlet and Outlet Connections	Relief Valve Connection	Shipping Weight	
			psig	cfh	psig	in.	mm	in.	mm			lbs.	kg
Acetylene	H-14	11P31	15	300	2.5	12-3/4	324	2-7/8	73	1/2 NPTF	3/4 NPTF	12	5.4
Alternate Fuels	H-16	13P16	13-28	300	2.5	12-3/4	324	2-7/8	73	1/2 NPTF	3/4 NPTF	12	5.4
Alternate Fuels	H-16	2120396	50-100	300	2.5	12-3/4	324	2-7/8	73	1/2 NPTF	3/4 NPTF	12	5.4

Gas Apparatus

Filters, Check/Relief/Dual Shutoff Valves

Steel Industry Products



High Capacity Line Filters

- Remove dirt, scale, and foreign materials from pipelines
- Prevent damage to valves, regulators, torches, etc.
- Reduce possibility of combustible particles igniting in pipeline
- 40 micron rating on 1 in. (25.4 mm) and 2 in. (51 mm) sintered bronze elements
- 140 mesh screen on 3 in. (76 mm) screen filter



2 in. (51 mm) filter

Gas Service	Size in.	Part Number	Maximum Operating Pressure	Maximum Flow	Overall Length		Body Diameter		Weight	
			psig	cfh	in.	mm	in.	mm	lbs.	kg
Oxygen	1 NPT	2116734	350	20,000	7-3/8	187	2-5/8	67	5-1/2	140
Fuel Gas	1 NPT	2116339	350	20,000	7-3/8	187	2-5/8	67	5-1/2	140
Oxygen	2 NPT	2116735	350	100,000	14	356	3-1/2	89	13-1/2	343
Fuel Gas	2 NPT	2116363	350	100,000	14	356	3-1/2	89	13-1/2	343

Heavy-Duty Check/Relief/Dual Shutoff Valves

Check Valves

- Wide assortment of NPTF thread check valves
- For oxygen and fuel gas service

Gas Service	Size		Part Number	Type
	in.	mm		
Oxygen	1/4	6.4	86W02	NPTF-Poppet
	1/2	13	2030506	NPTF-Poppet
	3/4	19	188W20	NPTF-Poppet
	1	25.4	2102243	NPTF-Poppet
	1-1/2	38	2117071	NPTF-Swing
Fuel Gas	1/4	6.4	86W02	NPTF-Poppet
	1/4	6.4	2028762	NPTF-Poppet
	3/4	19	2028759	NPTF-Poppet



1-1/2 in. (38 mm) swing check valve

Relief Valves

- Use with any non-corrosive, non-toxic industrial gas
- Easily maintained for long life
- Equipped with 3/4 in. (19 mm) NPT male inlet, 3/4 in. (19 mm) NPT female outlet (except RV-29 which has 3/8 in. fittings)

Model	Part Number	Relief Pressure
		psig
RV-28	11P63	20
RV-29	0558011945	60
RV-30	20069D10	45



RV-28

Valves

Steel Industry Products



Line or Station Shutoff Valves, Check Valves, Shutoff/Check Valve Combinations

V-53

- Ball type, 1/4 in. (6.4 mm) turn, inline shutoff valve
- Any non-corrosive, non-toxic industrial gas
- Gas may flow in either direction

V-54

- 90° throttle type shutoff valve
- Any non-corrosive, non-toxic industrial gas



V-53



V-53/CV-1 shown with check valve



V-54

Specifications & Ordering Information

Shutoff Valves

Model	Part Number	Maximum Operating Pressure		Connections	
		psig	kPa	Inlet	Outlet
V-53	639674	300	2,070	3/4 NPT female	3/4 NPT female
V-54	998184	400	2,760	1/2 NPT male	3/4 NPT female

Shutoff/Check Valve Combinations

Combination Part Number ¹	Check Valve		Gas Service	Check Valve Outlet Connection	Cap and Chain Assembly (Accessory)
	Symbol	Part Number ¹			
V-54					
998185	CV-1	639677	Oxygen	CGA-024 (7/8 - 14 RH male) ²	-
998186	CV-2	639710	Fuel Gas	CGA-025 (7/8 - 14 LH male) ²	-
998315	CV-3	639706	Oxygen	CGA-022 (9/16 - 18 RH male) ³	86W40
998317	CV-4	639711	Fuel Gas	CGA-023 (9/16 - 18 LH male) ³	86W41
998187	CV-5	639717	^	1/2 NPT male	-
998443	CV-6	639719	Inert Gas	CGA-034 (7/8 - 14 RH female) ²	-
998228	CV-7	639720	Inert Gas	CGA-032 (5/8 - 18 RH female) ³	-

Maximum Operating Pressure for all Shutoff/Check Valve Combinations is 200 psig.

¹Combination Part Number includes both shutoff valve and check valve.

²For connection to regulators with "C" size inlets.

³For connection to hose with "B" size fittings. Oxygen check valves are supplied, assembled, and sealed to the station valves; all other combinations are supplied unassembled.

⁴This Part Number is for check valve only.

^Any common non-corrosive, non-toxic industrial gas.

Gas Apparatus

PREST-O-LITE® Outfits



GT-200 Cutting Outfit

- Cutting range up to 1/2 in. (13 mm)
- Lightweight components
- For professional jewelry, light-duty repair, and maintenance work



Ordering Information

GT-200 DLX 540/510	0558005266
GT-200 DLX "B"	0558005267
GT-200 DLX "MC"	0558005268

Contents

W-200 torch	999805
CW-200 cutting attachment	05L20
Cutting tip 4202, 1/2 in. (13 mm)	16K09
Oxygen regulator R-22-75-540A	18564
Acetylene regulator R-22-15-510	998765
Acetylene regulator R-22-15-520 "B"	05X01
Acetylene regulator R-22-15-200 "MC"	05X02
Striker	790F34
Goggles	17862
Hose 12-1/2 ft. x 3/16 in. A-A "T" Grade	591F72

Precision Master Welding & Cutting Outfit

- Welding range up to 1/8 in. (3.2 mm)
- Cutting range up to 1/2 in. (13 mm)
- Lightweight components
- For professional jewelry, maintenance, and light-duty repair work
- Tanks not included



Ordering Information

Precision Master DLX "MC" with tote	600500
-------------------------------------------	--------

Contents

W-200 torch	999805
CW-200 cutting attachment	05L20
Cutting tip 4202, 1/2 in. (13 mm)	16K09
Welding head #4	06L48
Welding head #6	06L49
Welding head #9	06L50
Oxygen regulator R-22-75-540A	18564
Acetylene regulator R-22-15-200 "MC"	05X02
Striker	790F34
Goggles	17862
Hose 12-1/2 ft. x 3/16 in. A-A "T" Grade	591F72

PREST-O-LITE® Outfits



Maintenance Welding & Cutting Outfit

- Welding range up to 1/16 in. (1.5 mm)
- Cutting range up to 1/2 in. (13 mm)
- Lightweight components
- Everything you need for brazing, soldering, and cutting
- Tanks not included



Ordering Information

Maintenance Outfit DLX "B"	639103
Maintenance Outfit DLX "MC"	639130
Maintenance Outfit DLX "MC", tote.....	600499

Contents

W-200 torch	999805
CW-200 cutting attachment	05L20
Cutting tip 4202, 1/2 in. (13 mm)	16K09
Welding head #6	06L49
Striker	790F34
Goggles	17862
Hose 12-1/2 ft. x 3/16 in. A-A "T" Grade	591F72

POL Brazing Welding Outfit

- Welding range up to 1/8 in. (3.2 mm)
- Heating range up to 9 cfh acetylene (13,000 btu/hr.)
- Piston type connection between torch and heads for easy hand tightening
- Regulator burnout (RBO) protection in each regulator
- Tanks not included



Ordering Information

Prest-O-Pak DLX Brazing Outfit "MC" with tote.....	600498
----------------------------------------------------	--------

Contents

W-200 torch	999805
Welding head #4	06L48
Welding head #9	06L50
Oxygen regulator R-22-75-540A	18564
Acetylene regulator R-22-15-200 "MC"	05X02
Striker	790F34
Goggles	17862
Hose 12-1/2 ft. x 3/16 in. A-A "T" Grade	591F72

Gas Apparatus

PREST-O-LITE® W-200/CW-200

Light-Duty Combination Torch



- W-200 welding handle
- CW-200 cutting attachment
- Any fuel gas
- Welds 3/8 in. (9.5 mm), cuts 2 in. (51 mm)
- Heats 59,000 btu/hr. using cfh
- For light production welding, brazing, and cutting
- Solid brass forged body with drilled passages - no mixed gases in handle
- Ease-on control of cutting oxygen for smoother starts
- "A" sized inlet connections



Gas Apparatus



PUROX Cutting Tips Series

Cutting Attachment

CW-200	Part Number
90°	05L20

Acetylene
4202

Alternate Fuels
One-Piece 4203
One-Piece 4216
Two-Piece 4217



Welding Head, Acetylene Single Flame

Size	Steel Thickness		Part Number
	in.	mm	
1	32 ga		06L46
2	25-32 ga		06L47
4	1/32	0.8	06L48
6	1/16	1.6	06L49
9	1/8	3.2	06L50
15	3/16	4.8	06L52
30	3/8	9.5	06L54



Welding Handle

Description	Part Number
W-200	999805



Heating Head, Acetylene Multi Flame

Size	btu/hr.	Part Number
15	22,000	07L13
30	44,000	07L15
40	59,000	07L17



Twin Flame Head, Acetylene

Size	btu/hr.	Part Number
40	44,000	07L18

PREST-O-LITE® Air Gas Outfits



4-in-1 Outfit with Soft Flame Tips

- For all purpose soldering, heating, and brazing
- Meets most industrial demands
- “B” tank and “MC” tank models available
- Interchangeable tips - for proper flame size and heat
- Change tips in seconds - no tools necessary; tips lock in any working position
- Common torch handle - provides equivalent of five outfits
- Adjustable pressure regulator for steady gas delivery and stable flames



Ordering Information

4-in-1 Outfit	
“B” Tank	30X63
“MC” Tank	30X64

Swirljet® Outfit

- For faster soldering and brazing
- Superhot flame from Swirljet tips will silver - or alloy-braze pipe - faster than a conventional flame
- More effective - flame concentrates heat on work where needed; less waste
- Shorter wraparound flame allows soldering of joints within an inch of walls or woodwork without damaging or discoloring
- Efficient - for use under all weather conditions; wind will not deflect high velocity flame
- Adjustable pressure regulator with contents gauge and delivery pressure indicators on pressure adjustment knob



Ordering Information

Swirljet Outfit “B” Tank	998623
--------------------------------	--------

Gas Apparatus

PREST-O-LITE® Air Gas Outfits



General Purpose Air-Acetylene Outfits with Soft Flame Tip

- For sweat-type fittings, heating, and brazing
- Ideal for copper, brass, steel, and wrought iron pipe with solder-type fittings
- Precision flame control - for joints near a wall, against each other, and in hard-to-reach places
- Instant heat - 4,000°F (2204°C), without pumping or priming
- Convenient - small, light, easy to handle, and always ready to use
- Efficient - ample range for run-of-shop work; unaffected by drafts, wind, and rain
- “B” tank and “MC” tank models available
- Adjustable pressure regulator with contents gauge and delivery pressure indicators on pressure adjustment knob



Ordering Information

Air-Acetylene Outfit	
“B” Tank	30X37
“MC” Tank	30X38

Silversmith Outfit with Soft Flame Tip

- Includes all essential equipment required for fine silversmith and other detail work
- Similar to the General Purpose Outfit except that it contains a smaller torch tip, a shorter hose assembly, and a friction lighter



Ordering Information

Silversmith Outfit “B” Tank	639297
-----------------------------------	--------

PREST-O-LITE® Air Gas Outfits



PREST-O-LITE Ordering Information & Components

Air Acetylene Outfits	Part Number	4-in-1 Outfits		General Purpose Outfits		Silversmith Outfit	Refrigeration & Air-Conditioning Outfits		Swirljet Outfits
		30X63	30X64	30X37	30X38	639297	30X66	30X67	998623
Number 403 torch handle (valve at rear)	02X93	•	•	•	•	•	•	•	•
Number 1A fine torch tip	638948	•	•				•	•	
Number 3 light torch tip	10X23	•	•			•	•	•	
Number 3 Swirljet torch tip	21471								•
Number 4 medium torch tip	10X24	•	•	•	•		•	•	
Number 5 heavy torch tip	10X25	•	•						
Number 8 soldering iron (pointed copper)	11X18								
R-411B regulator (for "B" Tank)	04X36	•		•		•	•		•
R-411MC Regulator (for "MC" Tank)	04X37		•		•			•	
6 ft. length 3/16 in. (A-A) fitted hose assembly	501F11					•			
12 1/2 ft. length 3/16 in. (A-A) fitted hose assembly	501F12	•	•	•	•		•	•	•
Friction lighter	790F34					•			

Gas Apparatus

PREST-O-LITE® Torches

Handle and Tips



Model 403 Torch Handle

- Feature a quick-acting connection for fast tip changes without tools
- Standard and Swirljet tips fit interchangeably
- Control valve at the rear for handy shutoff and automatic gas regulation



Model 403

Ordering Information

Model 403

Number 403 torch handle (valve at rear) 02X93
 Needle valve for Number 403 torch handle 19X39

POL Standard Torch Tips

- Interchangeable with PREST-O-LITE 403 torch handle



Fine Soft Flame

Ordering Information

For Acetylene Use

Number 1-A

Fine Soft Flame - for fine jewelry work, telephone switchboard and other small-wire soldering, radiator fine soldering 638948

Number 3-A

Light Soft Flame - for many wire splicing assignments, some jewelry work, light sheet metal work 10X23

Number 4-A

Medium Soft Flame - for automobile body work and copper tube joints in the 1/2-1 in. (13-25 mm) range 10X24

Number 5-A

Heavy Soft Flame - for most heating jobs and for copper tubing joints in the 3/4-1-1/2 in. (19-38 mm) range 10X25



Soldering Iron

Number 6-A

Extra-Heavy Soft Flame - for maximum heating, such as needed for large-diameter copper tubing ... 10X26

Number 8-A

Soldering Iron with pointed copper 11X18
 Replacement Soldering Tip - Pointed 23S32

Number 8-C

Soldering Iron with chisel copper 11X17
 Replacement Soldering Tip - Chisel 23S20

Specifications - Operating Pressures & Gas Consumption & Replacement Parts

Tip Size	Flame Port Size		Operating Pressure Range	Gas Consumption	Mixer Disks	Filter Screw
	in.	mm	psig	cfh		
1A	1/10	2.5	1-5	0.2-1	638783	998311

PREST-O-LITE® Torches

Swirljet® Tips



In the Swirljet tip, mixed gases (air and fuel) are swirled at very high velocity through a propeller-like set of vanes at the rear of the flame tube. This swirling produces a much hotter, relatively short flame that concentrates heat output on the work. Swirljet tips are available for air-acetylene and air-fuel gas use.

- Superior to standard tips - provide maximum effective heating power
- Short wrap-around flame for close work - no heat damage to walls or woodwork as close as 1 in. (25 mm) away
- All weather use - protected, high velocity flame works in wind, rain and sub-zero temperatures
- Interchangeable with PREST-O-LITE 403 torch handle
- Run quieter, cooler, and give better heat transfer than other comparable tips



Acetylene Swirljet Tip



Fuel Gas Swirljet Tip



Tip Adaptor 19595

Operating Pressures

Swirljet air-acetylene tips require a minimum acetylene pressure of 13 psig and are so labeled. Do not use with any regulator preset to deliver 10 psig or less. Swirljet air-fuel gas tips require pressure of 24 psig with propane, 32 psig with propylene, and 36 psig with MAPP. Operating at too low a pressure will cause overheating at the flame tube.

Ordering Information

Tip Adaptor

Used to connect threaded POL air-acetylene or air-propane tips to Quick Disconnect torch handles 19505

Filter Screw Assembly

For all tips - except #5 acetylene 998311
For #5 acetylene tips..... 998312

Gas Apparatus

POL Swirljet Tips - Acetylene

Model	Part Number	Fuel	Pressure Gas Flow			Copper Tubing Size and Capacity				Replacement Mixer Tip
						Soft Solder		Silver Braze		
			psig	cfh	btu	in.	mm	in.	mm	
SJ-0A	22588	Acetylene	13	2	3,000	1/8-1/2	3-13	1/8-1/4	3-6	21478
SJ-1A	22589	Acetylene	13	3.6	5,300	1/4-1	6-25	1/8-1/2	3-13	0558001907
SJ-2A	22590	Acetylene	13	5.7	8,300	3/4-1-1/2	19-38	1/4-3/4	6-19	0558001908
SJ-3A	21471	Acetylene	13	7.2	16,500	1-2	25-50	1/2-1	13-25	21481
SJ-4A	21472	Acetylene	13	12.8	18,500	2-4	50-100	1-2	25-50	21482
SJ-5A	21473	Acetylene	13	33.8	50,000	4-6	100-150	1-4	25-100	21483

POL Swirljet Tips - Propylene

Model	Part Number	Fuel ¹	Pressure Gas Flow			Copper Tubing Size and Capacity				Replacement Mixer Tip
						Soft Solder		Silver Braze		
			psig ²	cfh	btu	in.	mm	in.	mm	
SJ-3LPG	21474	Propylene	32	1.5	3,500	1/4-1-1/2	6-38	1/4-1/2	6-38	21478
SJ-4LPG	21475	Propylene	32	3.1	7,300	1/4-2-1/2	6-63.5	1/4-1-1/4	6-32	21479
SJ-5LPG	21476	Propylene	32	8.0	19,000	1-4	25-100	1/2-2	13-50	21480

¹These tips can also be used with propane and MAPP gas.

²24 psig with propane, 36 psig with MAPP.

Operating at too low a pressure will cause overheating at the flame tube.

PREST-O-LITE® Kits

Air-Acetylene Swirljet® kits



X-3B POL Kit

- Flexible kit bronze brazes light/medium gauge steel
- Soft solders to 4 in. (100 mm)
- Silver brazes to 2 in. (50 mm)
- “B” tank connection
- Quick Disconnect - interchangeable with TurboTorch® and Goss® handles and tips



X-4B POL Kit

- Higher capacity kit bronze brazes medium/heavy gauge steel
- Soft solders to 6 in. (150 mm)
- Silver brazes to 4 in. (100 mm)
- “B” tank connection
- Quick Disconnect - interchangeable with TurboTorch® and Goss® handles and tips



Ordering Information

X-3B POL Kit 21954

Contents

R-411B (CGA520) regulator 04X36
 POL QD#1 torch 21702
 QD-SJ-3A tip 21703
 QD-SJ-4A tip 21704
 Hose 12-1/2 ft. x 3/16 in. A-A Fuel Gas 501F12

Ordering Information

X-4B POL Kit 21955

Contents

R-411B (CGA520) regulator 04X36
 POL QD#1 torch 21702
 QD-SJ-4A tip 21704
 QD-SJ-5A tip 21705
 Hose 12-1/2 ft. x 3/16 in. A-A Fuel Gas 501F12

*TurboTorch® is a registered trade name of Thermadyne.
 Goss® is a registered trade name of Goss®.*

PREST-O-LITE® Kits

Air-Acetylene Swirljet® Kits



X-5B POL Kit

- Flexible lighter duty kit
- Soft solders to 2 in. (50 mm)
- Silver brazes to 1 in. (25 mm)
- “B” tank connection
- Quick Disconnect - interchangeable with TurboTorch® and Goss® handles and tips



X-6MC POL Kit

- All purpose kit for using “MC” tank
- Soft solders to 2 in. (50 mm)
- Silver brazes to 1 in. (25 mm)
- “MC” tank connection
- Quick Disconnect - interchangeable with TurboTorch® and Goss® handles and tips

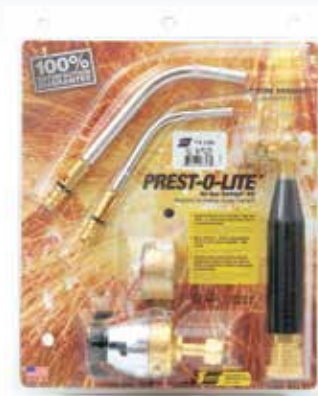

Ordering Information

X-5B POL Kit 21956

Contents

R-411B (CGA520) regulator 04X36
 POL QD#1 torch 21702
 QD-SJ-3A tip 21703
 Hose 12-1/2 ft. x 3/16 in. A-A Fuel Gas 501F12
 Friction Lighter..... 790F34

Ordering Information

X-6MC POL Kit 21957

Contents

R-411MC (CGA200) regulator 04X37
 POL QD#1 torch 21702
 QD-SJ-3A tip 21703
 QD-SJ-4A tip 21704
 Hose 12-1/2 ft. x 3/16 in. A-A Fuel Gas 501F12

*TurboTorch® is a registered trade name of Thermadyne.
 Goss® is a registered trade name of Goss®.*

Gas Apparatus

PREST-O-LITE® Kits

Air-Acetylene Kits



PZ-5A "MC" Kit

- Self-lighting tip
- Soft solders to 2 in. (50 mm)
- Silver brazes to 1 in. (25 mm)
- "MC" tank connection
- Quick Disconnect - interchangeable with TurboTorch® and Goss® handles and tips



Ordering Information

PZ-5A "MC" Kit 0558003175

Contents

R-411MC (CGA200) regulator 04X37
POL QD#1 torch 21702
PZ5A tip 22575
Hose 12-1/2 ft. x 3/16 in. A-A Fuel Gas 501F12
Kit available with R-411B regulator 0558003176

*TurboTorch® is a registered trade name of Thermadyne.
Goss® is a registered trade name of Goss®.*

PREST-O-LITE® Torches

QD Handle and QD Swirljet® Tips



Swirljet Tips & Torch Handle

These Swirljet tips are designed to be used with the PREST-O-LITE #1 Quick Disconnect torch handle. They run quieter and cooler, and give better heat transfer than other comparable tips.

- Quick disconnect
- Interchangeable with TurboTorch® and Goss® handles and tips



Interchangeable with TurboTorch® & Goss® Handles & Tips

Description	Part Number	Replaces TurboTorch Model
POL #1 Quick Disconnect Torch Handle	21702	G-4

PZ Spark Lighting Tip - Acetylene

- One-handed operation
- No need for a separate spark lighter
- Swirl flame for maximum heat transfer



Air Acetylene, Swirl Flame, Auto-Ignite Tips

Quick Connect		Replacement Tip End		Copper Tubing Size Capacity Using 15 psig Acetylene				
Model Number	Part Number	Model Number	Part Number	Soft Braze		Silver Braze		Gas Flow
				in.	mm	in.	mm	cfh
PZ-3A	22602	PZ-3ATR	22605	1/4-1	6-25	1/8-1/2	3-13	3.5
PZ-4A	22603	PZ-4ATR	22606	3/4-1-1/2	19-38	1/4-3/4	6-19	5.1
PZ-5A	22575	PZ-5ATR	22607	1-2	25-50	1/2-1	13-25	6.8
PZ-6A	22604	PZ-6ATR	22608	2-4	50-100	1-2	25-50	9.1

TurboTorch® is a registered trade name of Thermadyne.
Goss® is a registered trade name of Goss®.

Gas Apparatus

PREST-O-LITE® Torches

QD Handle and QD Swirljet® Tips



Acetylene Swirljet Tips - Quick Disconnect

Description	Part Number	Replaces TurboTorch Model	Fuel	Pressure psig	Gas Flow cfh	Copper Tubing Sizing and Capacity				Replacement Mixer Tip
						Soft Braze		Silver Braze		
						in.	mm	in.	mm	
QD SJ-OA	22591	A-2	Acetylene	13	2	1/8-1/2	3-13	1/8-1/4	3-6	21478
QD SJ-1A	22592	A-3	Acetylene	13	3.6	1/4-1/2	6-13	1/8-1/2	3-13	0558001907
QD SJ-2A	22593	A-5	Acetylene	13	5.7	3/4-1-1/2	19-38	1/4-3/4	6-19	0558001908
QD SJ-3A	21703	A-8	Acetylene	13	7.2	up to 2	up to 50	1/2-1	13-25	21481
QD SJ-4A	21704	A-14	Acetylene	13	12.8	2-4	50-100	1-2	25-50	21482
QD SJ-5A	21705	A-32	Acetylene	13	33.8	4-6	100-150	1-4	25-100	21483

Gas Apparatus



Fuel Gas Swirljet Tips - Quick Disconnect

Description	Part Number	Replaces TurboTorch Model	Fuel	Pressure psig	Gas Flow cfh	Copper Tubing Sizing and Capacity				Replacement Mixer Tip
						Soft Braze		Silver Braze		
						in.	mm	in.	mm	
QD SJ-3LPG	21706	T-3	Propylene ¹	32	1.5	1/4-1-1/2	6-38	1/4-1/2	6-13	21478
QD SJ-4LPG	21707	T-4	Propylene ¹	32	3.1	1/4-2-1/2	6-63.5	1/4-1-1/4	6-32	21479
QD SJ-5LPG	21708	T-5	Propylene ¹	32	8.0	1-4	25-100	1/2-2	6-50	21480
QD SJ-6LPG	21709	T-6	Propylene ¹	32	16.2	1-6	25-150	3/4-4	19-100	21482

¹These tips can also be used with propane and MAPP gas (refer to instruction literature for appropriate pressures and flows for these gases). Filter Screw Assembly #998311 (for all tips - except #5 acetylene).

TurboTorch® is a registered trade name of Thermadyne.

PREST-O-LITE® Torches

Air-fuel



PZ-503 & Accessories

- Self-igniting torch; burn propylene, MAP/PRO or propane gas
- Adjustable flame control

Ordering Information

PZ-503 torch	22533
PZ-503 torch kit with MAP/PRO cylinder	22536
12 ft. (3.6 m) hose assembly ¹	22579
Adaptor ²	22580

¹Connects PZ Torches and SS-9 to CGA-510 fuel gas cylinder.
²Connects PZ Torches and SS-9 to "B" LH size fuel gas hose.



PZ-503 torch kit



Adaptor



12 ft. (3.6 m) hose assembly

PREST-O-LITE® Regulators



Pressure Regulators

- Small and lightweight, yet rugged and dependable
- Outperform regulators twice their size
- Oxygen models have patented, built-in Regulator Burnout (RBO) protection
- Fine mesh inlet filters prevent contamination



Specifications & Ordering Information

R-411

Gas	Model	Part Number	Maximum Delivery Pressure	Outlet Connection	Gauges	
			psig		Contents	Delivery Pressure
"B" Acetylene Tank (40 cfh)	R-411B	04X36	15	"A" size	*	none
"MC" Acetylene Tank (10 cfh)	R-411 MC	04X37	15	"A" size	*	none

*Graduated as follows: full, 3/4, 1/2, 1/4, empty.

R-22

Gas	Model	Part Number	Maximum Delivery Pressure	Outlet Connection	Gauges	
			psig		Contents	Delivery Pressure
Acetylene						
"B" Acetylene Tank (40 cf)	R-22-15-520	05X01	15	"B" size	*	15 psi
"MC" Acetylene Tank (10 cf)	R-22-15-200	05X02	15	"B" size	*	15 psi
Standard Acetylene Cylinders with CGA 510 Outlet	R-22-15-510A	998765	15	"A" size	4,000 psi	15 psi
Oxygen						
Standard Oxygen Cylinders with CGA 540 Outlet	R-22-75-540A	18564	75	"A" size	4,000 psi	100 psi

*Graduated as follows: full, 3/4, 1/2, 1/4, empty.

R-36

Gas	Model	Part Number	Maximum Delivery Pressure	Outlet Connection	Gauges	
			psig		Contents	Delivery Pressure
Inert Gas	R-36-500-580	21365	500	1/4 flared 37°	4,000 psi	400 psi

PREST-O-LITE® Regulators



Regulator Replacement Gauges

Regulator Part Number	Regulator Description	Contents Gauge (Colored)	Contents Gauge (White)	Delivery Gauge (Colored)
21365	R-36-500-580	22441 (Blue)	21938 (White)	22442 (Blue)
18564	R-22-75-540A	21868 (White)	-	21866 (White)
998765	R-22-15-510A	21867 (White)	-	21865 (White)
20969	R-22-15-510B	21867 (White)	-	21865 (White)
05X01	R-22-15-520	21867 (White)	-	21865 (White)
05X02	R-22-15-200	21867 (White)	-	21865 (White)
22238	R-522-15-520	22322 (Red)	-	22324 (Red)
22239	R-522-15-200	22322 (Red)	-	22324 (Red)
22241	R-522-15-510	22322 (Red)	-	22324 (Red)
22492	R-522-CF-580	22506 (Blue)	-	22507 (Red)
04X36	R-411B	18695 (Red) ¹	-	-
04X37	R-411MC	18695 (Red) ¹	-	-
05X38	R-416LPG	-	-	18700 (Red)
21806	R-511MC	21812 (Red)	-	-

¹Dial actually marked with fractional contents of acetylene cylinders (1/4, 1/2, 3/4, full).
 Dial shade refers to decorative background color: Red - Fuel Gas; Green - oxygen; White - for any gas that is not oil pumped.
 Gauge markings: "USE NO OIL." "RB" models are for acetylene. Blue - for any gas EXCEPT oxygen.
 Used on all inert gas regulators.

Gas Apparatus

Ordering Information

Replacement Windows

- 2-1/2 in. (63.5 mm), 1/4 turn twist-lock 18858
- 2 in. (50 mm), 1/4 turn twist-lock 18859
- 2 in. (50 mm), snap-in 18702



2-1/2 in. (63.5 mm), 1/4 turn twist-lock



2 in. (50 mm), 1/4 turn twist-lock



2 in. (50 mm), snap-in

PREST-O-LITE® Adaptors



To Make Connection Between

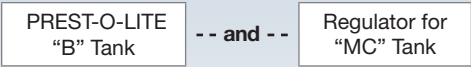

Use This Adaptor

Description	Part Number
"B" to "MC"	119X07



To Make Connection Between

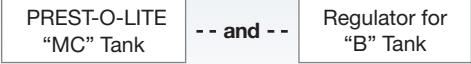

Use This Adaptor

Description	Part Number
"MC" to "B"	19X41



To Make Connection Between

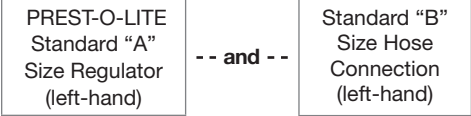

Use This Adaptor

Description	Part Number
"A" to "B" Hose Connection	18Z56
	3/8-24 in. RH female to 9/16-18 in. LH male



To Make Connection Between

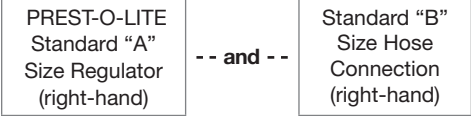

Use This Adaptor

Description	Part Number
"A" to "B" Hose Connection	18Z57
	3/8-24 in. RH female to 9/16-18 in. RH male



To Make Connection Between

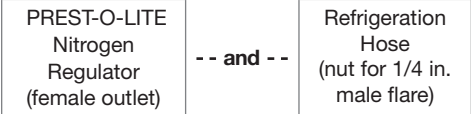

Use This Adaptor

Description	Part Number
Outlet Reducer	17544
	5/8-18 in. male to 7/16-20 in. male



PREST-O-LITE® Accessories



POL Purging & Pressure Testing

Using a refrigerant for purging contaminants from a system is no longer acceptable. To remove contaminants from a system and remain environmentally safe, use dry nitrogen. To assure the system is clean of contaminants before charging with refrigerants, purge the system with low pressure dry nitrogen when brazing. Testing a system for leaks with nitrogen will save time and money. PREST-O-LITE's Nitrogen Regulator R-36-500-580 can deliver up to 500 psig to pressurize a system for leak testing at operating pressure. Always use manufacturer's recommended specifications for maximum test pressure before testing.



NPK-40S



NPK-40TS

NPK-40S (22546)

- 6 ft. (2 m) hose
- OSHA rated blow gun
- R-36-500-580 regulator
- Carrying stand
- Multiple uses: purges, blows, leak tests

NPK-40TS (22545)

- 40 cu.ft. tank, refillable, empty
- 6 ft. (2 m) hose
- OSHA rated blow gun
- R-36-500-580 regulator
- Carrying stand
- Multiple uses: purges, blows, leak tests

Specifications Nitrogen Purge Kit

Description	Part Number	Model Number
40 cu. ft. carrying stand	88F82	NPA-S
40 cu. ft. nitrogen cylinder	22544	NPA-T
Blow gun	22542	NPA-G
Charging hose, 6 ft. (2 m)	22543	NPA-H
Blow gun and hose assembly	22548	NPA-GH
Blow gun, hose assembly and regulator	22547	NPA-GHR

Carrying Stand & Kangaroo Cart

- Carrying stand available in 2 styles
- Kangaroo cart accommodates "R" and "MC" cylinders



Carrying stand



Kangaroo cart

Specifications & Ordering Information

Description	Part Number	Cylinders Accommodate	Height		Width		Weight	
			in.	mm	in.	mm	lbs.	kg
Cart, small, rubber wheel	88F69	Small Medical	41	1041	12	305	6	3
Carrying stand	88F82	-	28-3/4	730	7-3/4	197	3-4/5	2
Kangaroo cart	0558003632	"R" and "MC"	24	610	12-1/4	311	2-1/2	1
Bracket, wall mount single	88F71	1K or 1T	-	-	-	-	2	0.9
Bracket, wall mount double	88F72	2K or 2T	-	-	-	-	3-1/2	1.5

Gas Apparatus



Personal Protection Equipment





Personal Protection Equipment

Table of Contents

Helmets & Head protection

New-Tech ADC Plus Helmets	240
Aristo Tech 9-13 Helmet	242
Warrior Tech 9-13 Helmet	244
Globe-Arc Helmet	246
Helmets and Head Protection Accessories	249

Welding Gloves

Gloves for GMAW/SMAW	251
Gloves for GTAW and general handling	252

Eye Protection

Safety glasses	253
Goggles	253
Accessories	254

Clothing

Proban Jacket	256
FR Line	257
Apron & Shop Coat	258

Starter Packs

Weld Warrior Pro & Elite	259
--------------------------------	-----

HELMETS AND HEAD PROTECTION

New-Tech™ ADC Plus Helmets

The New-Tech ADC Plus series of auto-darkening welding helmets offer the latest in safety technology. The new Angular Dependence Compensation Plus (ADC) feature ensures that the selected shade covers the full width and height of the LCD screen, plus improves color definition and contrast throughout the cartridge. With a wide viewing area, New-Tech ADC Plus helmets give you a feeling of increased space awareness. The helmet is designed to meet the requirements of all position welding including overhead welding.

The New-Tech ADC Plus models are very lightweight and balanced, and the headgear can be adjusted for maximum comfort. The helmet's shell is designed to give maximum protection to your face, neck, and ears. You'll also be able to breathe easy, thanks to a large area in front of the mouth that ensures proper flow of fresh air and low levels of CO₂. The black finish on the exterior shell of the New-Tech ADC Plus helps to reflect heat and increases the helmet's resistance to high temperatures. Cartridges are powered by solar cells and automatically activated by light. And you can work with confidence, knowing Weld Warrior™ New-Tech ADC Plus helmets are ANSI approved.



Personal Protection

New-Tech 6-13 XL ADC Plus **0700 000 955**

The New-Tech 6-13 XL ADC Plus can be used for almost any welding application with adjustable shade levels from DIN 6 to DIN 13. The helmet features a grinding mode, which allows the ADF screen to be switched off for grinding, and has sensitivity and delay functions. The XL lens measures 3.77 x 2.96 in. (96 x 68.5 mm), offering you an increased field of vision.

New-Tech 9-13 ADC Plus **0700 000 957**

The New-Tech 9-13 ADC Plus is suitable for GTAW, GMAW, SMAW, and gas welding and cutting. The helmet offers a cartridge that improves color and light contrast – allowing you to distinguish colors through the lens in an open and activated state. Settings such as shade level DIN 9-13, sensitivity, and delay are made from the outside of the helmet.



New-Tech helmets available in USA only.

Spares for New-Tech 6-13 XL ADC Plus

2/3	Cartridge and Adjustment Knob Kit	0700 000 270
4	Supporting Frame	0700 000 220
5	Metal Locking Spring	0700 000 221
6	Inside Cover Lens	0700 000 268
7	Front Sweat Band	0700 000 231
7	Rear Sweat Band	0700 000 232
8	Headgear Complete	0700 000 222

Spares for New-Tech 9-13 ADC Plus

1	Helmet Shell Silver	0700 000 314
2	Cartridge Internal Adjustment	0700 000 313
2/3	Cartridge and Adjustment Knob Kit	0700 000 273
4	Supporting Frame	0700 000 220
5	Metal Locking Spring	0700 000 221
6	Inside Cover Lens	0700 000 228
7	Front Sweat Band	0700 000 231
7	Rear Sweat Band	0700 000 232
8	Head Gear Complete	0700 000 222

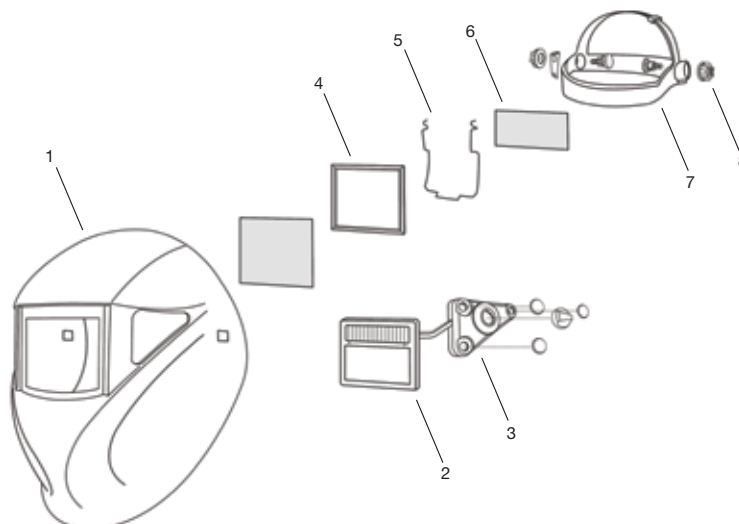

HELMETS AND HEAD PROTECTION

Aristo® Tech 9-13 Helmet

The Aristo Tech helmet is designed for the professional welder who wants the best in protection and performance. The helmet features ADF technology and has an internal LCD display, providing the welder full control to adjust shade level from DIN 5 to DIN 13. The helmet also has sensitivity and delay settings with precision for any welding application. The Quick Set™ feature allows for easy change of shade with a simple up-and-down flick of the switch. The Aristo Tech Grind mode is activated at the lowest sensitivity.

The light-weight shell and ergonomically designed head gear offers maximum comfort even when welding for long periods of time. The operator has the ability to move the helmet closer or further away from the face, making it comfortable and easy to wear.

The Aristo Tech 5-13 weighs only 1 lb. (0.5 kg) and is suitable for GMAW, GTAW, SMAW, grinding, and manual plasma cutting. The helmet is designed to meet the requirements of all position welding including overhead welding. Aristo Tech helmets are ANSI approved.

Aristo Tech 5-13 - Black	0700 000 374
Aristo Tech 5-13 - Yellow	0700 000 375
Aristo Tech 5-13 - White	0700 000 376



Personal Protection

Spares for Aristo Tech 5-13

1	Head Gear Aristo Tech	0700 000 368
2	Sweat Band Aristo Tech	0700 000 369
3	Front Cover Lens Aristo Tech	0700 000 370
4	Inside Cover Lens Aristo Tech	0700 000 371
5	Cartridge 5-13 ADF Assembly	0700 000 391
6	Potentiometer / Sensitivity Knobs	0700 000 373

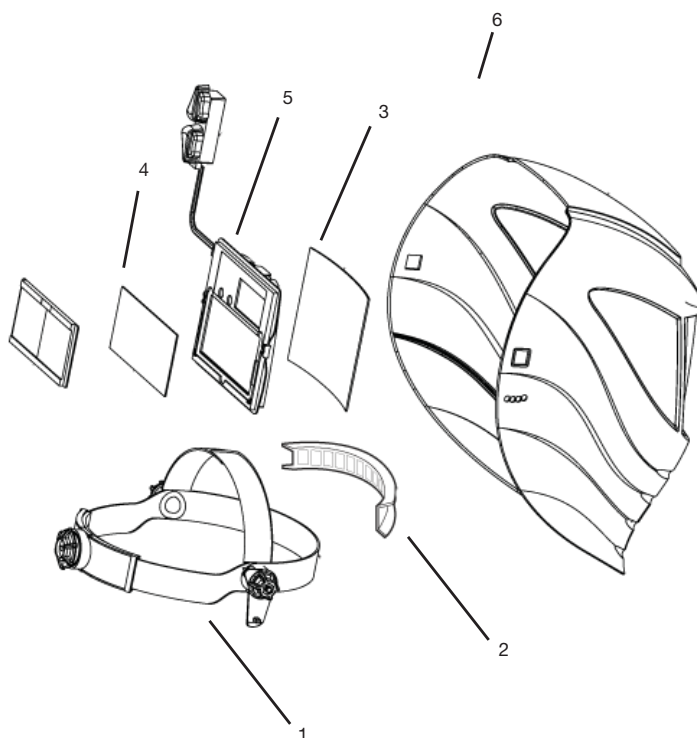

HELMETS AND HEAD PROTECTION

Warrior™ Tech 9-13 Helmet

The Warrior Tech helmet is designed to meet the needs of welders, featuring a high-tech, lightweight shell for protection from heat, sparks, and spatter. The large welding lens provides optimal viewing area with excellent quality using the latest auto-darkening filter (ADF) technology.

The Warrior Tech 9-13 features external shade adjustment between DIN 9 and DIN 13, and optical class 1/2/1/2. Delay and sensitivity can be adjusted from the inside.

The Warrior Tech also features four arc sensors for higher response and wider coverage and a large viewing area of 3.85 x 1.88 in. (98 x 48 mm) providing a wider field of vision and increased spatial awareness.

Sensitivity control is an adaptable feature useful when welding low amperages (GTAW) for better reaction to darker arc light. The helmet also features delay control enabling the welder to set how long the lens stays dark after the welding arc stops. Short delay helps get the job done faster during tack welding, whilst longer delay is useful for high amperage welding.



Personal Protection



Warrior Tech 9-13 – Black 0700 000 400

Warrior Tech 9-13 – Yellow 0700 000 401



Spares for Warrior Tech 9-13

1	ESAB Head Gear Pro with sweat band	0700 000 415
2	Sweat Band, pack of 2	0700 000 244
3	Front Cover Lens	0700 000 010
4	Inside Cover Lens	0700 000 416
5	ESAB 9-13 ADF Cradle	0700 000 418
6	Lens Retainer with Screws	0700 000 419

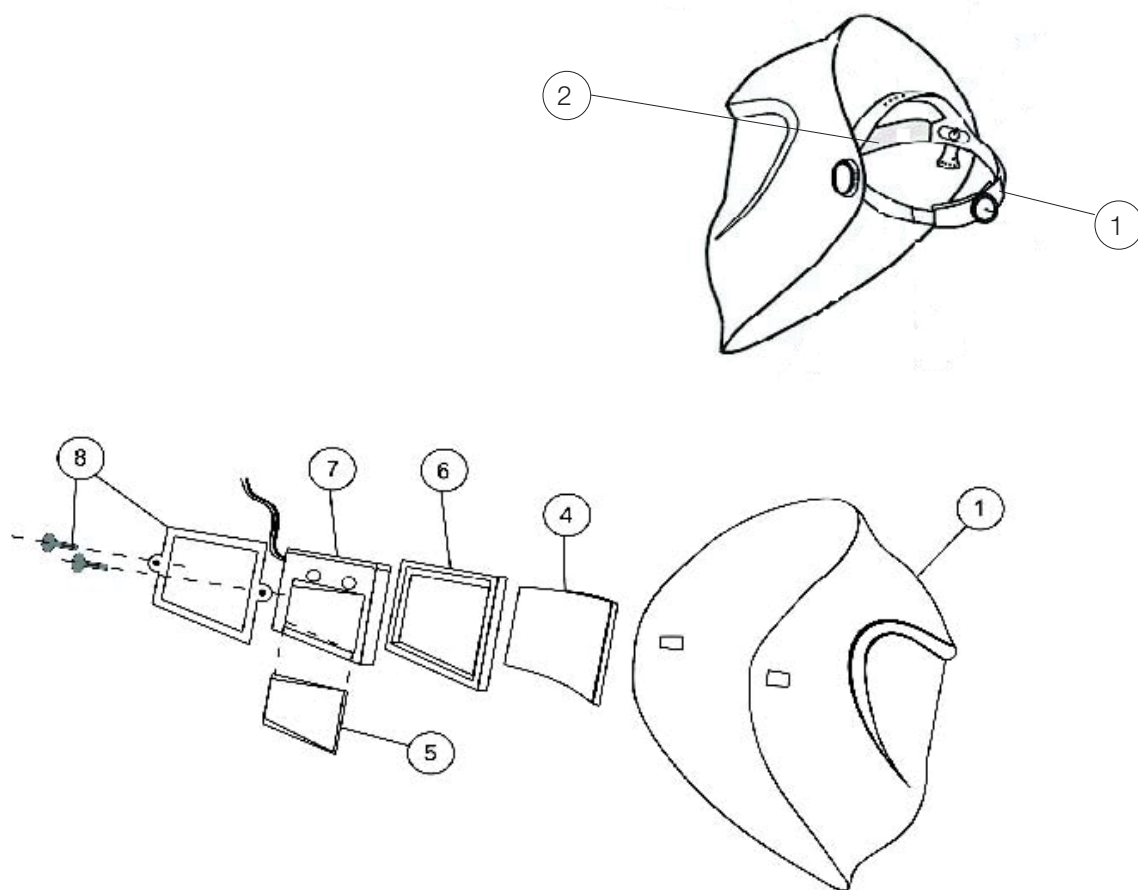

HELMETS AND HEAD PROTECTION

Globe-Arc Helmet

The Globe-Arc helmet provides outstanding protection for all kinds of metal working including arc welding, grinding, gas cutting, gas welding, and plasma cutting. Its design is unique to flip-front and grinding helmets, and is equipped with strong, comfortable headgear. The Globe-Arc's visor, along with a combination of inner and outer lenses, provides full protection against IR, UV, and visible light. Plus, inner lenses are available in a variety of different shades – DIN 2, DIN 3, and DIN 5.



Globe-Arc Shade 7	0700 000 308
Globe-Arc Shade 10	0700 000 947
Globe-Arc Shade 11	0700 000 943



Globe-Arc helmets available in USA only.

Personal Protection



Spares for Globe-Arc

1	Hinge Set	0700 000 267
2	Large Inner Visor Globe-Arc Clear	0700 000 238
2	Large Inner Visor Globe-Arc DIN 2	0700 000 239
2	Large Inner Visor Globe-Arc DIN 3	0700 000 240
2	Large Inner Visor Globe-Arc DIN 5	0700 000 241
3	Outer Flip Visor Globe-Arc DIN 5	0700 000 242
3	Outer Flip Visor Globe-Arc DIN 8	0700 000 247
3	Outer Flip Visor Globe-Arc DIN 10	0700 000 248
4	Flip-Up Globe-Arc Holder	0700 000 249
5	Head Gear Globe-Arc	0700 000 243
6	Sweat Band	0700 000 244

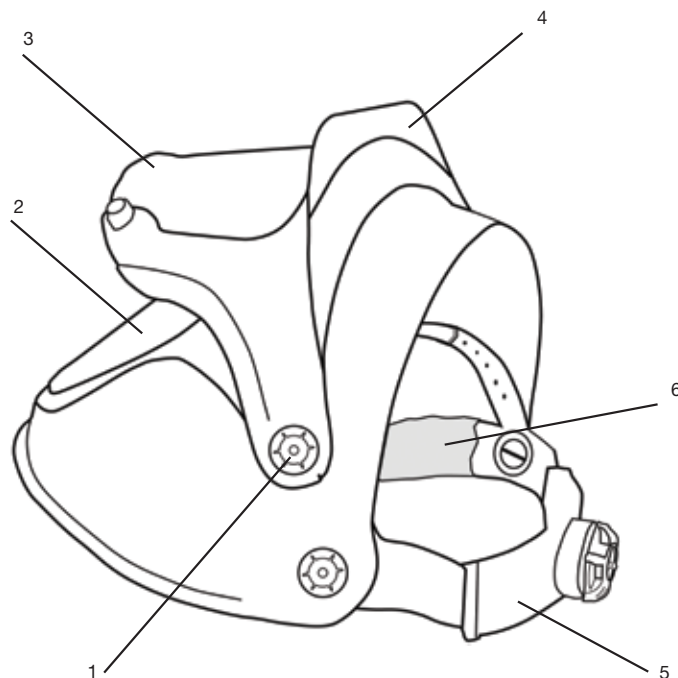



HELMETS AND HEAD PROTECTION

Proban® hood 0000 593 269

Flame-resistant head protection that covers the head, neck, and shoulders.



Insulated helmet liner 0000 904 378

The insulated helmet liner is worn underneath the welding helmet to offer protection when working in a cold environment.



Hard hat for New-Tech

The hard hat for New-Tech provides you with the lightest, strongest, and most comfortable helmet available. The hard hat is manufactured from ABS material, and weighs less than a pound. Head gear is equipped with a ratchet adjustment for easy adjustment and comfort.



Hard Hat – Yellow 0700 000 052

Adaptor for hard hat 0700 000 230



HELMETS AND HEAD PROTECTION

Leather helmet pad **747F92**

Made of top-grain cowhide with foam cushion and rust-resistant hardware to provide ultimate protection and comfort.



Welder's cap

Cap to be worn under helmet to protect your head and hair.

Size S **781F96**

Size M **781F97**

Size L **781F98**



Personal Protection



WELDING GLOVES

Gloves for GMAW/SMAW

Curved GMAW glove

Weld Warrior gloves offer a whole new approach to fit, form, and function. Ergonomically designed to fit the natural curve of the hand, these GMAW gloves are made from heavy and fine-cut leather, and are lined from hand to cuff. With the curved design, the glove fits the hand perfectly, and also has a flexible wrist area that reduces friction. With welted seams, Kevlar® stitching, and reinforced thumb, Weld Warrior gloves are ultra strong and offer the highest level of protection.

Size L **0700 005 043**

Size XL **0700 005 040**



Heavy-duty black glove **0467 222 007**

A welding glove made of black, strong cow-grain leather. High dexterity with Kevlar® stitching ensures that the glove can resist hard mechanical stress. The gloves are also fully welted.





Heavy-duty aluminized glove **0700 005 010**

A welding glove with two layers of cowhide capable of withstanding extreme heat – suitable for tubular wire welding. The facing of aluminum-coated PFR rayon reflects 95% of the thermal radiation. Gloves are padded with COMFOflex®, and sewn with fourfold Kevlar®. The thumb is angled for high comfort.



All Weld Warrior gloves have a high resistance to heat and offer additional protection against spatter.

 **Tested against mechanical stress such as abrasion, cut, tear, and puncture.**

 **Tested for thermal performance, such as exposure to an open flame, contact heat, convective heat, radiant heat, and small and large splashes of molten metal.**

Personal Protection

WELDING GLOVES

Gloves for GTAW and general handling

Curved GTAW glove

You've never worn a GTAW glove quite like this. These Weld Warrior gloves are ergonomically designed to fit the natural curve of the hand, giving you quality and comfort like none other. Made from thin, high-quality leather with improved fit for higher dexterity, the gloves are highly durable, with welted seams and Kevlar® stitching. They're also extremely lightweight for additional comfort.

Size L 0700 005 041

Size XL 0700 005 042



GTAW professional glove

0701 415 963

A quality GTAW gauntlet with a reinforced thumb and 5.1 in.-long leather cuff. The palm is fully lined for increased comfort and protection.



Personal Protection



EYE PROTECTION

Safety glasses

Weld Warrior safety glasses are used for drilling, chipping, and metalworking. They have a sporty style, are soft to the touch, and have a lightweight wrap-around neck cord. The glasses are extremely flexible and durable, and are available in four different lens configurations that protect against UV radiation. Plus, all eyewear meets ANSI Z87.1 standards.

Warrior Clear **0700 012 030**

The clear lens is suitable when working indoors, providing general eye protection. Sold in multiples of 12 pairs.

Warrior Smoked **0700 012 031**

The smoked lens is suitable when working in strong ambient light. Sold in multiples of 12 pairs.

Warrior Amber **0700 012 032**

The amber (yellow lens) enhances the light – suitable when the ambient light is not sufficient. Sold in multiples of 12 pairs.

Warrior Shade 5 **0700 012 033**

The DIN 5 shade lens provides protection not only against IR/UV light, but also against the visible light during gas welding/cutting. Sold in multiples of 12 pairs.

Goggles

Goggle Shade 5 **17862**

A one-piece goggle with a soft molded body, indirect ventilation, and a 4 x 1.75 in. lens aperture. The goggle is fitted with a Shade 5 filter, and will fit over prescription glasses.



Personal Protection

ACCESSORIES

Magnifying lenses for New-Tech

The New-Tech helmet can be equipped with a magnifying lens. The magnifying lens is fitted from the inside (so no adaptor is needed). Four different diopters are available: +1.0 / +1.5 / +2.0 / +2.5.

Diopter +1.0 **0700 000 084**

Diopter +1.5 **0700 000 085**

Diopter +2.0 **0700 000 086**

Diopter +2.5 **0700 000 087**



Easy-Lite

0700 014 040

The Easy-Lite is a small but effective light source that can be easily attached to your welding helmet, hard hat, safety glasses, or anywhere that additional light is required. It's also an excellent tool for adapting to a stainless steel inspection mirror. The bright LED is perfect for highlighting the weld in difficult places where there is insufficient light. Operation is a cinch – just turn it on by a simple swing. Also, the battery has over 50 hours of life.





CLOTHING

Proban® jacket

Weld Warrior Proban®/leather jackets are designed for maximum comfort and safety. Sleeves and shoulders are made of durable grade-A leather to withstand the exposure to welding spatter. The front and back are made from flame-retardant Proban material. The jacket features concealed inner pockets, adjustable sleeves, a stand-up collar, and Kevlar® stitching.



Size L 0700 010 302

Size XL 0700 010 303

Size XXL 0700 010 304



Personal Protection

CLOTHING

FR line

ESAB's FR line of flame retardant clothing is designed to give maximum protection to the professional welder while providing comfort in the most demanding environments.

Garments are made with Phoenix FR material, which gives the clothing 100% FR protection for the lifetime of the garment. There are no worries of washing out or wearing down the flame retardant fibers as these properties are an inherent part of the garment.

	Chest	The Jersey	The Fleece	The Winter
Size S	38 in.	0700010373	0700010368	0700010358
Size M	40 in.	0700010374	0700010369	0700010359
Size L	42 in.	0700010375	0700010370	0700010360
Size XL	44 in.	0700010376	0700010371	0700010361
Size XXL	46 in.	0700010377	0700010372	0700010362

The Jersey

- Lightweight
- For warmer climates

The Fleece

- Full zip front
- For cooler climates

The Winter

- Rugged
- For the coldest climates



Personal Protection

CLOTHING

Apron **0700 010 007**

The Weld Warrior protective apron distributes weight effectively. Plus, it's Kevlar® stitched and 42.1 in. long.



Shop coat

This knee-length, comfortable shop coat is styled to fit the way you work, with two lower front pockets plus breast pocket. Features simple snap-front closure and side slits for easy access to trouser pockets.

Size M **781F58**

Size L **781F59**

Size XL **781F60**

Size XXL **781F61**



Weld Warrior T-shirt and hat

To see the complete line of Weld Warrior casual clothing, visit esabna.com/weldwarrior.



Personal Protection

STARTER PACKS

Starter packs

Weld Warrior Starter Packs include everything for the welder who requires best in class personal protection products.

Weld Warrior Pro

- Warrior Tech 9-13 Helmet
choice of black or yellow
- Proban/Leather Jacket
- Curved GMAW Welding Gloves
- Origo Clear Safety Glasses
- Origo Smoked Safety Glasses
- Easy-Lite
- Tool Bag



	Black	Yellow
Size L	0558010140	0558010143
Size XL	0558010141	0558010144
Size XXL	0558010142	0558010145

Weld Warrior Elite

- New-Tech 6-13 ADC XL Helmet
- Proban/Leather Jacket
- Curved GMAW Welding Gloves
- Origo Clear Safety Glasses
- Origo Smoked Safety Glasses
- Easy-Lite
- Tool Bag



Size L	0558010146
Size XL	0558010147
Size XXL	0558010148

Weld Warrior Elite Starter Pack available in USA only.



Mechanized Cutting

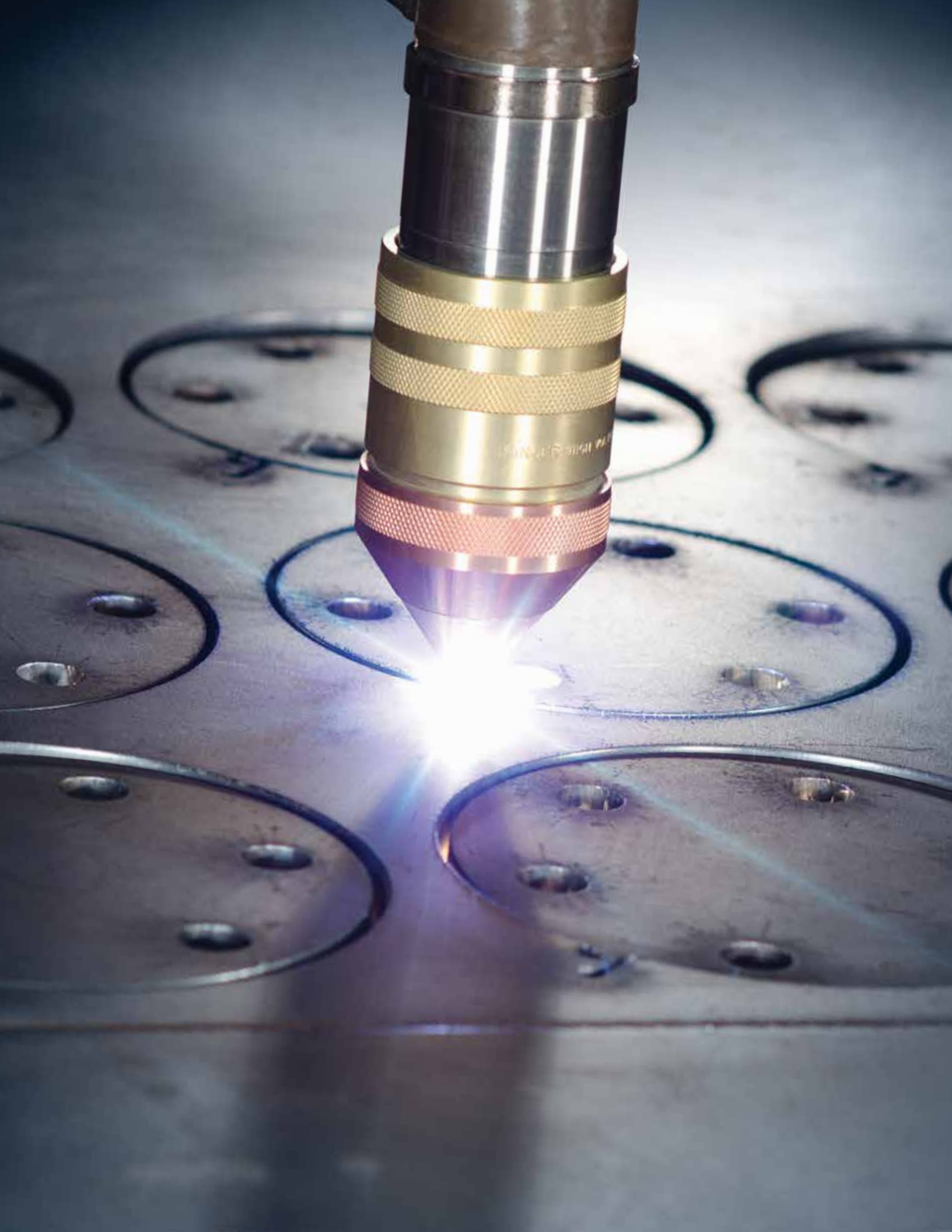



Mechanized Cutting Systems

Table of Contents

ESAB Cutting Systems	264
Ultra-Line	265
Ultra-Graph	266
Ultra-Line™ & Ultra-Graph Plasma Options	267
Silhouette 1000	268
Combirex DX	269

ESAB Cutting Systems

At ESAB, we're more than just order-takers, we're cutting experts, consultants, and partners.

And our history speaks for itself. With roots dating back to the early 1900s, we've been constant industry innovators for over a hundred years. We even hold the original patent for plasma cutting.

Since we manufacture the entire system, write our own software, and stand behind everything we make - there's no need for you to juggle different vendors to support individual components.

We offer everything from the simplest systems to the most complex - all from one reliable source. And as the only supplier that makes the entire system, only ESAB can integrate everything to work seamlessly together, creating new technologies that improve your productivity:

- **Precision Hole Technology, which vastly improves plasma hole quality**
- **Smart Voltage Height Control, which automatically compensates for electrode wear, ensuring best cut quality and maximum consumable life**
- **Smart Cycle Technology, which boosts productivity by streamlining process control and tool motion**

Whether upgrading an old machine or investing in a whole new system, we help you achieve your goals. And because we make the entire system, one call is all it takes to get professional support for everything. We also offer many value-added services that other suppliers can't, like free annual checkups, free torch replacement, and extended warranties!

The products offered in this catalog are our light-duty solutions. For the complete ESAB Mechanized Cutting product offering, including medium- and heavy-duty cutting systems, please visit www.esab-cutting.com, order our Mechanized Cutting Systems catalog MCUT-3078, or call us at 1.888.372.2288.



Plasma



Oxy-Fuel



Laser

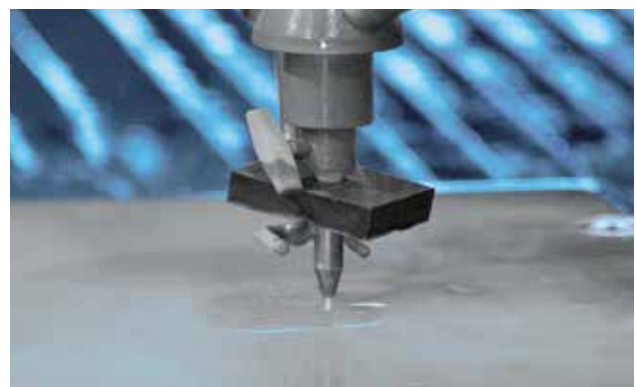

Waterjet

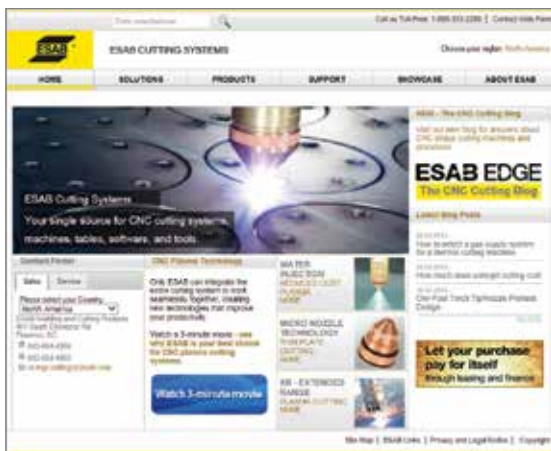

www.esab-cutting.com

- Solid state control
- Convenient, easily accessible controls
- Sturdy, one-piece, cast aluminum housing
- Knurled drive wheels for positive traction
- 6 ft. (2 m) track lengths
- Wide variety of accessories for expanded capability
- Speed range 3-1100 ipm (0.8- 2.8 m/min)
- Extensive variety of accessory equipment for expanded capability
- Standard 115/220V, 50/60Hz input power

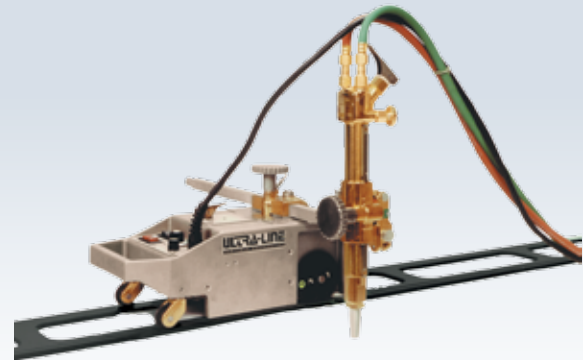

Ultra-Line with C-58 Torch, Rigging Assembly, and Track

The Ultra-Line is a lightweight, portable carriage designed for straight-line cutting applications. Widely used in a small metal fabricating operation, shipyards, and steel mills, the Ultra-Line can be adapted to many special applications with a wide variety of accessory equipment.

The Ultra-Line's one-piece aluminum housing measures 16 in. (406 mm) long, 7-1/4 in. (184 mm) wide, and 5-3/4 in. (146 mm) high without torch rigging. Weight is approximately 22 lbs. (10 kg) without accessories.

Using an OXWELD® oxy-fuel-gas machine cutting torch, the Ultra-Line can cut plate up to 4 in. thick (101.6 mm). With an accessory heat shield, the Ultra-Line can cut material up to 6 in. thick (152 mm).

With Solid State Control, no "warm-up time" is required to start the carriage travel. The carriage is driven by a reversible DC motor with built-in solid state speed regulation.

Ordering Information

Model	Power	Part Number
Basic Machine ¹	110V	2237258
Basic Machine with Torch-Acetylene ²	110V	2237262
Basic Machine with Torch-Propane ²	110V	2237266

Speed Range is 3-110 ipm (0.8-2.8 m/min).

¹Includes 6 ft. (10 m) track and torch holder.

²Complete with 6 ft. (10 m) track, torch holder, torch, and 3 tips.

Options & Accessories

Ultra-Line

Torch rigging assembly 16V90

Includes mounting unit, a 24 in. (609.6mm) rack, and torch holder.

Track - 6 ft. (10 m) V-grooved guide rail 16V82

Sections can be linked to extend length.

Heat shield kit 995586

For use with prolonged cutting, cutting thick material, or cutting close to carriage.

Options & Accessories continued

Counterweight 995587

Use when equipment mounted on one side of carriage causes an imbalance.

Manifolding kit 639659

Provides convenient means of connecting oxy/fuel-gas from regulators to torch.

Circle cutting attachment 16V84

Consists of an 18 in. (0.5 m) radius bar and pivot system, permitting 2-54 in. (0.05-1.4 m) diameter circle cutting.

Two torch operation 16V89 or 16V92

Adaptors that allow cutting with two torches.

Vertical post 491620

Allows cutting in the vertical plane.

Valve block assembly 07X26

Allows adjustment of oxy-fuel-gas flows on valveless torches.

Cutting Torch

Various devices that attach to an OXWELD cutting torch for versatility and added capabilities.

Quick acting valve assembly 32Y08

Substitutes for the standard cutting oxygen throttle valve.

Adjustable bevel cutting adaptor 18845

Connects to the torch like a nozzle and can be adjusted 0-90° from the torch center line.

Auxiliary Preheat Kits are available for preheating the plate ahead of the cut. Mounted to the bevel cutting adaptor:

Acetylene 61Y99

Other fuel gas 63Y13

Scissor-type slitting adaptor 22X42

Divides cutting operation into two nozzles to make parallel cuts ranging from 1-1/2 to 12 in. (38.1-304.8 mm) wide. The adaptor is mounted to the torch in place of the standard single nozzle.

Two-way inlet adaptor 18X20

Allows one oxygen inlet hose to supply preheat and cutting oxygen to a three inlet torch.

Ultra-Graph™

- Simple, accurate, magnetic tracing system lets you reproduce quickly and precisely, at speeds from 4-150 ipm (1.0-3.8 m/min)
- Variable-speed direct drive motor performs smoothly and dependably
- Cut shapes accurately and economically with a single-torch system that's become the industry standard
- Put all machine functions at your fingertips with the RC or DC series Ultra-Graph controls



Ultra-Graph with RC control, torch, and hose package

Since its introduction decades ago, the Ultra-Graph has become the industry standard for single torch contour cutting. Many fabricating shops have found the Ultra-Graph to be a practical, dependable design that allows cutting highly complex shapes inexpensively and accurately, in a fraction of the time required by other means.

A magnetic rotor follows the contours of a metal template. In turn, it guides the cutting arm and torch with exceptional precision. The Ultra-Graph can be either a floor standing or table mounted model, each providing a 60 in. (1.5 m) cutting radius.

Cutting and tracing speeds range from 4-150 ipm (1.0- 3.8 m/min), selectable by size of the magnetic rotor. The speed range required depends on the application, plate thickness, type of material and process. Rotors are available from 1/8 in. (3.2 mm) to 7/8 in. (22 mm), in 1/16 in. (1.6 mm) increments. The direct-drive motor allows precise speed control. The Ultra-Graph can be used for oxy-fuel or plasma-arc cutting or plasma, GMAW, and GTAW welding.

DC Series Control - The DC-Control features basic speed control and direction control (CW / OFF / CCW). Solid state, full-wave rectification ensures accurate speed control over the entire speed range. Also included are fuses and power indicator.

RC Series Control - Expanded capabilities are available with the RC-Control. It includes push-button controls to operate an oxy-fuel torch, as well as the optional torch ignitor. It also includes a solenoid valve for cutting oxygen control. Speed and direction controls are also included.

Ordering Information

Model	Part Number
DC/60 Floor Ultra-Graph	2232855
DC/60 Table Ultra-Graph	2232722
RC/60 Floor Ultra-Graph	2232851
RC/60 Table Ultra-Graph	2232721

Basic machine includes control unit, 1/4 in. rotor and 1/2 in. rotor. Does not include torch. All models have a 60 in. reach.

Options & Accessories

Transformer 50Hz 2236319

Standard rotors

1/8 in. (3.2 mm). 1301017
 3/16 in. (4.8 mm). 923107
 1/4 in. (6.4 mm). 923074
 5/16 in. (8 mm). 923108
 3/8 in. (9.5 mm). 923075
 7/16 in. (11 mm). 923109
 1/2 in. (12.7 mm). 923076
 5/8 in. (15.8 mm). 923110
 3/4 in. (19 mm). 923111
 7/8 in. (22.2 mm). 923112
 Rotor set (10 pieces) 1251501

Specifications

Ultra-Graph	
Operating radius, in. (m)	60 (1.5)
Circle - max. diameter, in. (m)	55 (1.4)
Straight - line - max., in. (m)	110 (2.8)
Weight - RC floor, lbs. (kg)	264 (120)
Weight - RC table, lbs. (kg)	192 (87)
Weight - DC floor, lbs. (kg)	248 (112.5)
Weight - DC table, lbs. (kg)	176 (80)
Power requirement	115V, 50/60Hz, 1ph

Ultra-Line™ & Ultra-Graph™ Plasma Options

- Easily upgrade from oxy-fuel to plasma cutting
- Easily switch between oxy-fuel and plasma cutting
- PT-37 air plasma torch features same diameter as oxy-fuel torches
- PT-37 torch includes rack for adjustment by manual torch holder
- PowerCut® 1300 and 1600 plasma systems featuring 70 or 90 amps

Both the Ultra-Line and Ultra-Graph machines may be equipped with a plasma cutting torch by ordering the following accessories: Plasma Cutting Torch, Plasma Power Supply, Plasma Torch Consumables, and Remote Control Switch.

Options & Accessories

1. PT-37 Plasma Cutting Torch

The PT-37 Torch includes a gear rack mounted to the side of the torch for manual vertical adjustments.

PT-37 torch with 25' leads..... 0558004862
 PT-37 torch with 50' leads..... 0558004863

2. Plasma Power Supply

Choose one of the following:

PowerCut 1300, 70A power supply..... 0558007881
 208/230/460V, 50/60Hz, 1/3ph.

PowerCut 1300, 70A power supply..... 0558007882
 400V, CE, 50Hz, 3ph

PowerCut 1600, 90A power supply..... 0558007883
 208/230/460V, 50/60Hz, 1/3ph

PowerCut 1600, 90A power supply..... 0558007884
 400V, CE, 50Hz, 3ph

Note: "CE" Items are used outside North America

3. Plasma Torch Consumables

Choose the spare parts kit necessary to support the plasma amperage available from the selected plasma power supply:

60A 0558008248
 70A 0558008247
 90A 0558008889

4. Remote Control Switch

Allows manual control of plasma ON/OFF.

Remote control switch, 25 ft. (7.6 m) cable 0558005548
 Remote control switch, 50 ft. (15.2 m) cable ... 0558005549



Ultra-Line with plasma torch



Ultra-Graph with plasma torch

Mechanized
Cutting

Silhouette™ 1000

- Rack-and-pinion drive in both axes
- Precision round rail system
- Expandable rail system in 15 ft. (4.5 m) sections
- Four station capacity
- HL-90 photo-optical tracer with command mark slowdown
- Forward offset for accurate corner cuts
- Tracing/cutting speeds from 2-120 ipm (0.5-3.0 m/min)
- Plates up to 4 in. (1.0 m) thick can be cut with a single oxygen/fuel-gas torch
- Automatic cutting oxygen shut-off

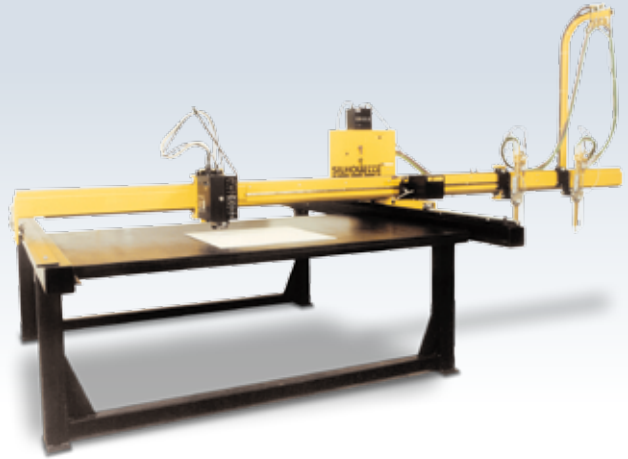

Silhouette 1000 with two motorized oxy-fuel torch stations

The Silhouette 1000 is ideally suited for a fabricating shop or maintenance department needing a high quality, photo-optical controlled shape cutting system.

All of the features combine into a system that gives the Silhouette 1000 the precision and stability needed for consistent, accurate cutting. Rack-and-pinion drives, rugged cross beam, and hardened round rails are standard equipment. Cutting and tracing widths of 4 and 6 ft. (1.3 and 1.8 m) are available.

With optional rail extensions and extra tracing tables, length can be established as required for your application.

The HL-90 will dependably give you years of service tracing lines as narrow as 0.030 in. (0.7 mm) at speeds from 2-118 ipm (0.05-3.0 m/min). Forward offset provides accurate corner cuts, while kerf compensation is adjustable up to 1/8 in. (3.2 mm). Cutting parameters are controlled from the HL-90 control panel including: direction of travel, speed, operating mode, power, and cutting oxygen.

The Silhouette 1000 has the capacity to handle up to four cutting stations. Station configurations can include four oxygen/fuel-gas torches, one plasma torch or combine up to three oxygen/fuel-gas stations and one plasma station. Optional manual/motorized lifts are available as well as a festoon system to ease movement of cables and hoses along the rail.

Ordering Information

Contact ESAB at 1.800.ESAB.123.

Options & Accessories

- Tracing table
- Festoon systems
- Plasma cutting systems
- Rail extensions
- Motorized torch stations

Specifications

Silhouette 1000	4 ft. (1.3 m)	6 ft. (1.8 m)
Cutting width, in. (m)	48 (1.2)	72 (1.8)
Tracing width, in. (m)	48 (1.2)	72 (1.8)
Machine width, in. (m)	130 (3.3)	168 (4.3)
Cutting length, in. (m)	144 (3.7)	144 (3.7)
Machine length, in. (m)	180 (4.6)	180 (4.6)
Maximum torch capacity	4	4
Maximum plasma	1	1
Speed range, ipm (mm/min)	2 - 120 (50 - 3048)	2 - 120 (50 - 3048)
Power requirement	115V, 50/60Hz, 1ph	115V, 50/60Hz, 1ph

- 3-axis gantry with rack-and-pinion drives
- Reinforced box beam design provides a solid, precision platform for the cutting tool
- Precision linear rail y-axis guide way for greater accuracy
- ESAB's Vision CNC, Windows®-based, networkable, with color LCD
- Digital AC drive amplifiers for years of maintenance free operation
- AC brushless motors for wide speed range with accurate speed control
- Precision, heavy-duty gearboxes for accuracy and smooth motion



The Combirex DX offers large gantry design and performance in a compact package. The rugged gantry features all-steel construction with machined mating surfaces for stiffness and accuracy. Heavy-duty H-beam weldments support triple machined T-rails to provide a sturdy, stable foundation, and easy installation on any concrete floor. Featuring a precision linear rail Y-axis guiding system, precision three-axis rack-and-pinion drives, digital AC drives and AC brushless motors, this machine delivers the cutting performance you would expect from much more expensive gantries.

The Combirex DX can be equipped with air plasma systems up to 100 amps or ESAB's m³ Precision Plasmarc System, which allows the machine to cut and mark with the same plasma torch. The m³ system is available on the Combirex DX in 200 Amps, 360 Amps, and 450 Amps configurations.

The plasma station includes a pneumatically balanced initial height sensor along with an electrical clear-the-plate feature, for the softest, most accurate tool-tip initial height sensing. Arc Voltage Height Control provides accurate cutting height and a magnetic break-away crash protection system prevents torch damage in case of tipped parts.

The Combirex DX may be equipped with up to 4 oxy-fuel cutting stations. The stations feature heavy-duty motorized lifters with capacitive height control and pilot flame torch ignitors. An electronic proportional valve gas control sets high/low preheat pressures, cutting oxygen pressure, and pierce ramp automatically through the built-in process database.

With the Combirex DX, plate marking can be accomplished by the m³ plasma system or by an optional air scribe marker, allowing accurate marking and cutting on the same parts.

Specifications

Combirex DX	2500	3000	3500	4000
Recommended max. plate width, ft. (m)	5 (1.5)	6 (2)	8 (2.4)	10 (3)
Maximum cross travel with 1 tool, in. (m)	78.7 (2)	98.4 (2.5)	118.1 (3.0)	137.8 (3.5)
Maximum cross travel with 2 tools, in. (m)	78.7 (2)	98.4 (2.5)	118.1 (3.0)	137.8 (3.5)
Maximum cross travel with 3 tools, in. (m)	70.9 (1.8)	90.5 (2.3)	110.2 (2.8)	129.9 (3.3)
Maximum cross travel with 4 tools, in. (m)	62.9 (1.6)	82.7 (2.1)	102.4 (2.6)	122 (3.1)
Rail gauge, in. (m)	98.4 (2.5)	118.1 (3.0)	137.8 (3.5)	157.5 (4.0)
Internal clearance, in. (m)	86 (2.2)	106 (2.7)	126 (3.2)	145 (3.7)
Maximum table outside width, in. (m)	77 (1.9)	96.5 (2.5)	116 (2.9)	136 (3.5)
Machine width, in. (m)	142.7 (3.6)	162.4 (4.1)	182.1 (4.6)	201.8 (5.1)
Machine height, in. (m)	83 (2.1)	83 (2.1)	83 (2.1)	83 (2.1)
Work table height, in. (m)	26-30 (0.7-0.8)	26-30 (0.7-0.8)	26-30 (0.7-0.8)	26-30 (0.7-0.8)
Parking area, in. (m)	56 (1.5)	56 (1.5)	56 (1.5)	56 (1.5)
Speed range, ipm (m/min)	2-1,000 (0.05- 25.4)	2-1,000 (0.05- 25.4)	2-1,000 (0.05- 25.4)	2-1,000 (0.05- 25.4)
Power requirement	230/460/575V, 50/60Hz, 1ph, 30A (special input voltages are available upon request)			



Welding Automation

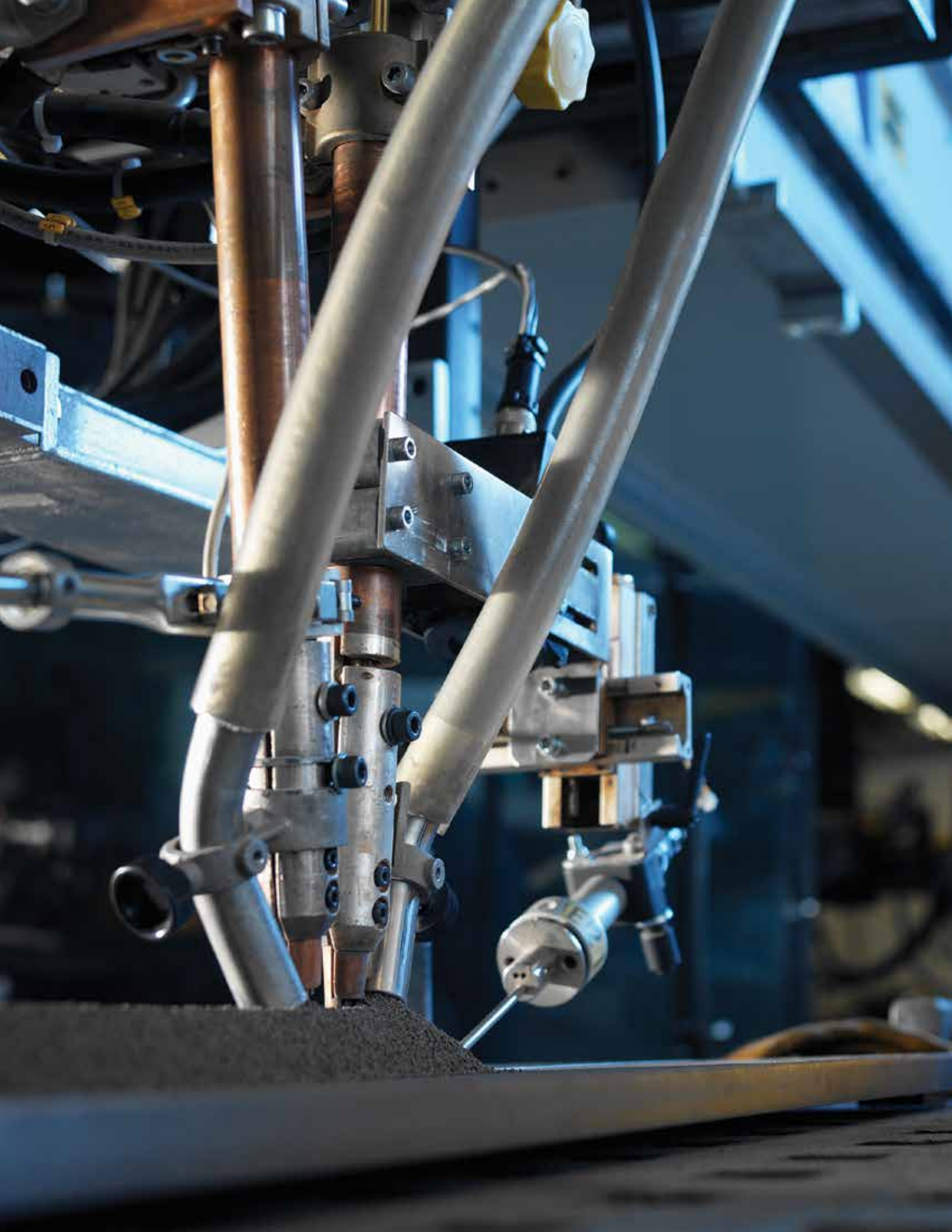

Welding Automation

Table of Contents



ESAB Welding Automation	274
Welding Tractors	
Railtrac 1000	275
Miggytrac 1001	278
Miggytrac 2000	279
A2 Multitrac PEI	280
A2 Multitrac PEK	281
A6 Mastertrac	282
Controllers	
A2 PEI Process Controller	283
A2-A6 PEK Process Controller	284
Power Sources	
LAF 631, 1001, 1251 & 1601	285
TAF 801 & 1251	287
ARISTO 1000 AC/DC SAW	288
Welding Heads	
A2S Mini Master	290
A2 Component System Modularization	291
A6S Arc Master	292
A6 Component System Modularization	293

ESAB Welding Automation

The 21st century has brought many new challenges to the metal fabrication industry: metal fabricators must meet the demand for increased quality while providing their customers with an overall lower cost; productivity is challenged by the shortage of skilled workers; profitability is challenged by the pressure from intense global competition. As a result, manufacturers are required to utilize new fabrication techniques to build increasingly complex designs and structures.

Welding automation meets some of these challenges with higher quality, capacity, and, of course, much higher productivity than manual welding applications. At ESAB, we develop and manufacture a wide range of mechanized and automated welding products to create the special solution you might need.

Whether your metal fabrication project requires simple components, such as tractors, or requires large turn-key systems and production lines, we offer a full range of automation products to meet every need including the widest range of consumables in the world.

You can also rely on ESAB for total system responsibility. Because we manufacture our own equipment, we can integrate the welding process, arc path, and material handling. An integrated design simplifies the equipment, improves reliability, and ensures unsurpassed performance.

We encourage you to consult one of our Welding Automation Experts for more details regarding processes, applications, and customized solutions.

The products offered in this catalog are for standard submerged arc welding (SAW) applications. For the complete ESAB Welding Automation product offering, including medium- and heavy-duty systems, handling equipment, accessory components, and special applications, please visit www.esabna.com, order our Welding Automation Equipment catalog #AUT-1004, or call us at 1.800.ESAB.123.



Tractors



Power Sources



Handling Equipment



Special Applications



Welding Automation Equipment Catalog

Railtrac 1000

Multi-Purpose System for Welding and Cutting

- Ideal for automated gas metal arc welding (GMAW)
- Made from aluminum and steel parts to withstand harsh environments
- Ideal for horizontal to horizontal and vertical (up only) welding
- Can be customized with a wide range of accessories
- New joint system allows for both stiff and flexible rail applications
- Straightforward, well designed programming unit with up to 5 different programs
- Standard software offers programmable interval welding and backfill function
- Operator can control machine motions with hand held remote without lifting welding visor
- Remote control available on FW1000/FWR1000 with start/stop, shift program, weaving width, zero line displacement, and many more features
- Adjust welding current and voltage during welding with the two potentiometers on the remote control



Specifications

	Railtrac F1000 Flexi	Railtrac FR1000 Flexi Return	Railtrac FW1000 Flexi-Weaver	Railtrac FWR1000 Flexi-Weaver-Return
Mains supply, V AC/DC	36-46/40-60	36-46/40-60	36-46/40-60	36-46/40-60
Max power consumption, W	30	30	80	80
Weight, excl rails, lbs. (kg)	13 (6)	13 (6)	15 (7)	15 (7)
Dimensions, LxWxH, in. (mm)	6.7x15.8x7.5 (170x400x190)	6.7x15.8x7.5 (170x400x190)	6.7x13.8x7.5 (170x350x190)	6.7x13.8x7.5 (170x350x190)
Flexi rail dimensions, LxW, in. (mm)	2.4x0.2 (60x5)	2.4x0.2 (60x5)	2.4x0.2 (60x5)	2.4x0.2 (60x5)
Stiffener bar, LxW, in. (mm)	1.6x0.4 (40x10)	1.6x0.4 (40x10)	1.6x0.4 (40x10)	1.6x0.4 (40x10)
Min bend diameter, external, in. (mm)	118 (3000)	118 (3000)	118 (3000)	118 (3000)
Slide for height adjustment, in. (mm)	±0.87 (±22)	±0.87 (±22)	±0.87 (±22)	±0.87 (±22)
Mechanical lateral adjustment, in. (mm)	-	-	±1.4 (±35)	±1.4 (±35)
Welding speed, ipm (cm/min)	3.9-59 (10-150)	3.9-59 (10-150)	3.9-59 (10-150)	3.9-59 (10-150)
Quick transport, ipm (cm/min)	59 (150)	59 (150)	59 (150)	59 (150)
Preheating time, sec	0.0-9.9	0.0-9.9	0.0-9.9	0.0-9.9
Interval welding, in. (cm)	0.4-39 (1-99)	0.4-39 (1-99)	0.4-39 (1-99)	0.4-39 (1-99)
Crater-filling time, sec	0.0-9.9	0.0-9.9	0.0-9.9	0.0-9.9
Backfill, in. (mm)	0-3.9 (0-99)	0-3.9 (0-99)	0-3.9 (0-99)	0-3.9 (0-99)
Weaving speed, ips (mm/s)	-	-	0.2-2.4 (6-60)	0.2-2.4 (6-60)
Weaving width, in. (mm)	-	-	0.04-1.2 (1-30)	0.04-1.2 (1-30)
Electrical 0-line displacement, in. (mm)	-	-	±0.5 (±12.5)	±0.5 (±12.5)
Pause time at outer edge, s	-	-	0.0-9.9	0.0-9.9
Weaving pattern, No.	-	-	3	3
Number of programs	5	5	5	5
Temperature, °F (°C): Machine and magnets Vacuum attachments	32-158 (0-70) 32-194 (0-90)	32-158 (0-70) 32-194 (0-90)	32-158 (0-70) 32-194 (0-90)	32-158 (0-70) 32-194 (0-90)
Enclosure class	IP 23	IP 23	IP 23	IP 23

Railtrac 1000

System Configuration

Railtrac F1000 Flexi

A mechanized system with a flexible combi-rail, suitable for both inside and outside welding and cutting along sharp curves as well as straight surfaces. This model is also suitable for thermal cutting.



Railtrac FR1000 Flexi Return

Railtrac FR1000 has the combi-rail and facilities for movable start and stop for automatic return for any length. This system is ideal for use in fixed installations or where a weld is repeated over and over again.

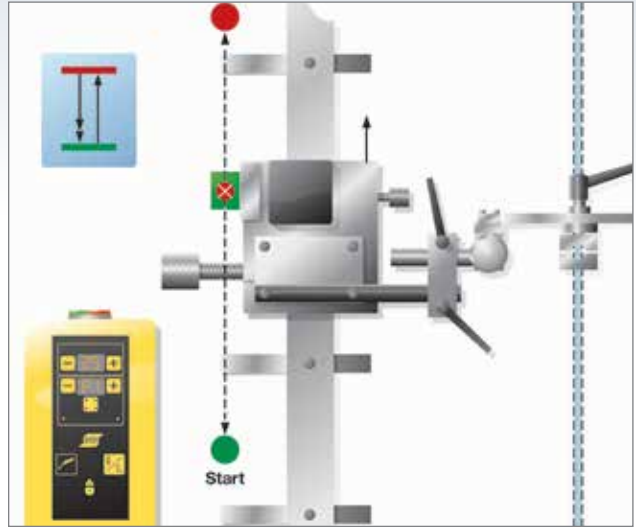

Railtrac FW1000 Flexi Weaver

This version has a flexible combi-rail and a weaver for weaving in many different patterns. It is also equipped with a remote-controlled unit with a user-friendly design.



Railtrac FWR1000 Flexi Weaver Return

Like the Flexi Weaver, this system has a weaving unit, but it also has adjustable start, stop, and return facilities. Equipped with a remote control unit with a unique design, this is a very advanced solution for a variety of applications.

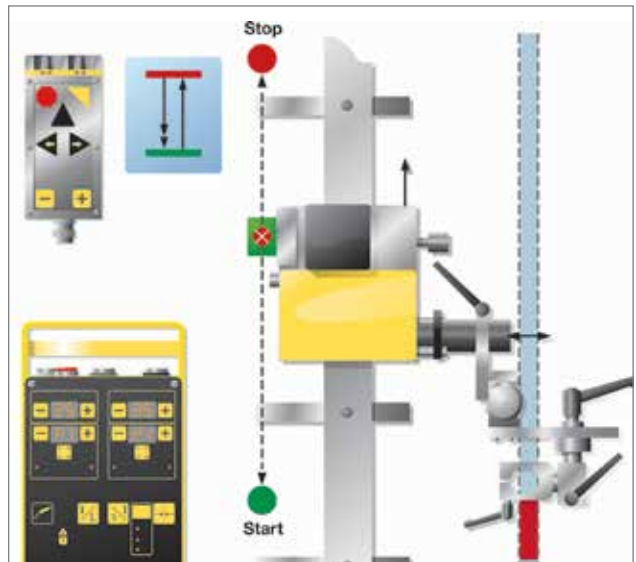

Railtrac 1000



Ordering Information

Railtrac F1000 Flexi	0398146002
Railtrac FR1000 Flexi Return	0398146003
Railtrac FW1000 Flexi Weaver	0398146012
Railtrac FWR1000 Flexi Weaver Return	0398146013

Options & Accessories

The following accessories are included:

- Weaving unit¹
- Control unit
- Remote control¹
- Universal torch holder with slide
- Automatic start and stop function²

¹FW1000/FWR1000 only.

²FR1000/FWR1000 only.

Components

Flexible alu-rail, 8 ft. (2.5 m)	0398146115
Flexible alu-rail, 8 ft. (2.5 m), 8 magnets	0398146112
Flexible alu-rail, 8 ft. (2.5 m), vacuum attachments	0398146113
Stiffener Bar, 8 ft. (2.5 m)	0398146116
Magnetic attachment 90°, min. 8/8 ft. (8/2.5 m)	0398146100
Vacuum attachment 90°, min. 4/8 ft. (4/2.5 m)	0398146104
Vacuum attachment 200°, min. 4/8 ft. (4/2.5 m)	0398146105
Screw attachment for stiffened rail	0398146114
Transformer kit, 115-42V	359C304

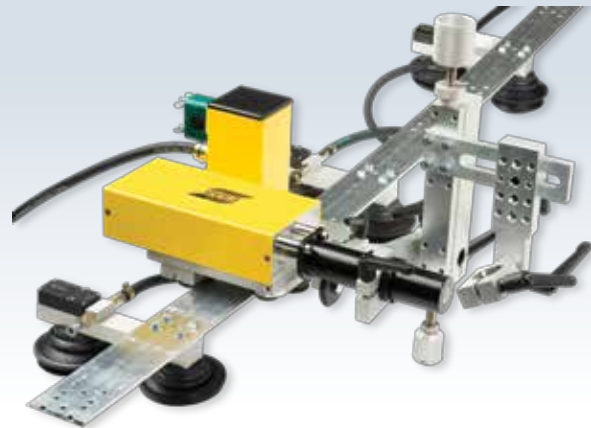

Accessories

Torch holder	0398145101
Universal pivoted torch holder	0398145104
Attachment for IMP cutting torch	0398145260
Torch angle attachment	0398145215
Tilt unit for weaving unit ¹	0398145200
Turning unit for weaving unit ¹	0398145201
Floating head	0398145211
IMP cutting torch	0398145250
Transport and storage box	0398145199
Control cable, 16.4 ft. (5 m)	0457360880
Aristo® Feed wire feeder adaptor kit	0458757881
Universal control cable, 16.4 ft. (5 m)	0457360881
Transformer kit, 42V	0457467880

¹FW1000/FWR1000 only.



Miggytrac 1001

For Use with GMAW Power Sources

- Small, compact, motorized tractor
- Easy to attach to ESAB welding torch
- The tractor is held in position on the workpiece with a magnet, even if the workpiece is bent or angled
- Remote-controlled travel
- Start/stop function from the remote control panel
- Travel speed settings of 6-47 ipm (0.15-1.2 m/min), wire feed speed, and voltage all functions of the remote control
- Significantly increased welding speed, especially when using cored wire



Ordering Information

Miggytrac 1001..... 0457357881

Options & Accessories

Control cable, 16.4 ft. (5 m)¹ 0457360880
 AristoFeed adaptor kit² 0459681880
 Universal control cable, 16.4 ft. (5 m)³ 0457360881
 Welding screen 0457463880
 Transformer kit, 115-42V359C304

¹12 pin male-23 pin male Burndy style Origo Feed and Aristo Feed feeders.

²Required for connection of Miggytrac to Aristo Feed feeders.

³12 pin male Burndy style open-end. Requires user-supplied plug to connect cable to OEM feeders.

Specifications

Miggytrac 1001	
Control voltage, V AC	36-46
Power, W	20
Welding speed, ipm (mm/min)	6-47 (150-1200)
Remote control outlet	Volt and ampere (wire feed speed)
Connection	Burndy, 12 pins
Dimensions, LxWxH, in. (mm)	10.5x10x10.5 (266x257x267)
Weight, lbs. (kg)	15.4 (7)

Miggytrac 2000

For Use with GMAW Power Sources

- Ideal for long welds eliminating stressful welding positions for the welder
- The tractor is held in the correct position on the workpiece with a magnet, even if the workpiece is bent or angled
- Guide wheels adjust to allow the unit to drive itself against the workpiece
- Program for intermittent welding
- Set length of weld and distance between welds from 0.4-39 in. (1-99 cm)
- High-speed travel between welds - 98 ipm (250 cm/min) - for increased efficiency
- Backfill function for crater filling at the end of the weld
- Adjust the welding current and voltage during welding with the two potentiometers on the control panel (when using ESAB equipment)



Ordering Information

Miggytrac 2000..... 0457358880

Options & Accessories

Control cable, 16.4 ft. (5 m)¹ 0457360880
 Aristo® Feed adaptor kit² 0459681880
 Universal control cable, 16.4 ft. (5 m)³ 0457360881
 Welding screen 0457463881
 Transformer kit, 115-42V 359C304

¹12 pin male-23 pin male Burndy style OrigoFeed and Aristo Feed feeders.

²Required for connection of Miggytrac to Aristo Feed feeders.

³12 pin male Burndy style open-end. Requires user-supplied plug to connect cable to OEM feeders.

Specifications

Miggytrac 2000	
Control voltage, V AC	36-46
Power, W	40
Welding speed, ipm (mm/min)	6-59 (150-1500)
Fast travel speed, ipm (cm/min)	98.4 (250)
Programmable interval welding, in. (cm)	0.4-37 (1-99)
Linear slide stroke length (horizontal), in. (mm)	±0.67 (±17)
Remote control outlet	Volt and ampere (wire feed speed)
Connection	Burndy, 12 pins
Crater fill time, s	0-9.9
Backfill, in. (cm)	0-4 (0-9.9)
Dimensions, LxWxH, in. (mm)	13x10x14 (330x260x360)
Weight, lbs. (kg)	21 (9.5)

A2 Multitrac PEI

Universal Welding Tractor for SAW and GMAW

- Can be connected to most analog, DC power supplies
- Compact and efficient design allows for easy movement between workpieces
- Self-propelled, four-wheel drive for stable, accurate, and constant operation
- A2 PEI process controller allows simple setting of travel speed, voltage, and wire feed speed
- Heavy-duty feed unit ensures an even and stable wire feed for top quality, homogenous welding
- Horizontal, vertical, and rotary slides allow for quick adjustment of the nozzle into various positions
- Reliable mechanical components, even under harsh working conditions
- Easy to use control equipment with different start methods; direct or scratch start.
- Wide range of accessories available
- Units available for gas metal arc welding (GMAW) and submerged arc welding (SAW)



Ordering Information

A2 Multitrac PEI, SAW..... 0449360880
 A2 Multitrac PEI, SAW Twin..... 0449360881
 A2 Multitrac PEI, GMAW 0449361880

Options & Accessories

Guide wheel bogie 0413542880
 Idling roller (2 per tractor) 0333164880
 Guide bar, 10 ft. (3 m) 0154203880
 V-guide wheel (2 required)..... 0333098881
 V-wheeltrack in steel (set of 4)..... 0443682881
 Loop for connection of two tractors 0334680881
 Laser lamp kit 0821440880
 Lincoln Electric interface..... 34351L
 Miller interface 34351M

Specifications

A2 Multitrac PEI	Single SAW	Twin SAW	GMAW
Wire diameters, in. (mm):			
Steel	1/16-5/32 (1.6-4.0)	2x 0.45x3/32 (2x1.2-2.5)	.030-1/16 (0.8-1.6)
Stainless steel	1/16-5/32 (1.6-4.0)	2x 0.45x3/32 (2x1.2-2.5)	.030-1/16 (0.8-1.6)
Cored wire	1/16-5/32 (1.6-4.0)	-	.045-3/32 (1.2-2.4)
Aluminum	-	-	.045-1/16 (1.2-1.6)
Max wire feed speed, ipm (m/min)	354 (9)	354 (9)	630 (16)
Wire reel weight, lbs. (kg)	66 (30)	2.2x33 (2x15)	66 (30)
Flux hopper capacity, gal. (L)	1.4 (6)	1.4 (6)	-
Permissible load 100%, A	800	800	600
Control voltage, V AC	42	42	42
Travel speed, ipm (m/min)	4-67 (0.1-1.7)	4-67 (0.1-1.7)	4-67 (0.1-1.7)
Linear slides stroke length, in. (mm)	3.5 (90)	3.5 (90)	3.5 (90)
Rotary slide setting angle	360°	360°	360°
Weight, excl wire and flux, lbs. (kg)	104 (47)	104 (47)	95 (43)

A2 Multitrac PEK

Universal Welding Tractor for SAW and GMAW

- The A2 Multitrac, with A2-A6 PEK process controller, is available for both submerged arc welding (SAW) and gas metal arc welding (GMAW)
- Choose single or twin wire for submerged arc welding (SAW)
- The feed unit secures an even, stable wire feed speed
- Four-wheel drive ensures accurate travel speed
- Digital control panel allows exact pre-set and control of welding parameters
- A2 Multitrac is fully mobile and can easily be moved from one welding station to another
- Can be quickly set-up for different workpieces
- Designed for use with ESAB LAF (DC), TAF (AC), and ARISTO® 1000 AC/DC welding power sources
- Units available for gas metal arc welding (GMAW) and submerged arc welding (SAW)



Ordering Information

A2 Multitrac PEK, SAW	0461233880
A2 Multitrac PEK, SAW Twin	0461233881
A2 Multitrac PEK, GMAW.....	0461234880
A2 Multitrac PEK, GMAW 4WD, MTW 600	0461234881

Options & Accessories

Guide wheel bogie	0413542880
Idling roller (2 per tractor)	0333164880
Guide bar, 10 ft. (3 m)	0154203880
V-guide wheel (2 required).....	0333098881
V-wheeltrack in steel (set of 4).....	0443682881
Loop for connection of two tractors	0334680881
Laser lamp kit	0821440880

Specifications

A2 Multitrac PEK	Single SAW	Twin SAW	Single GMAW	GMAW w/ MTW 600
Wire diameters, in. (mm)				
Steel	1/16-5/32 (1.6-4.0)	2x0.45x3/32 (2x1.2-2.5)	.030-1/16 (0.8-1.6)	.040-1/16 (1.0-1.6)
Stainless steel	1/16-5/32 (1.6-4.0)	2x0.45x3/32 (2x1.2-2.5)	.030-1/16 (0.8-1.6)	.040-1/16 (1.0-1.6)
Cored wire	1/16-5/32 (1.6-4.0)	-	.045-3/32 (1.2-2.4)	.040-3/32 (1.0-2.4)
Aluminum	-	-	.045-1/16 (1.2-1.6)	.040-5/64 (1.0-2.0)
Max wire feed speed, ipm (m/min)	354 (9)	354 (9)	630 (16)	984 (25)
Wire reel weight, lbs. (kg)		2x33 (2x15)	66 (30)	66 (30)
Flux hopper capacity, gal. (L)	1.4 (6)	1.4 (6)	-	-
Permissible load 100%, A	800	800	600	600
Control voltage, V AC	42	42	42	42
Travel speed, ipm (m/min)	4-67 (0.1-1.7)	4-67 (0.1-1.7)	4-67 (0.1-1.7)	4-67 (0.1-1.7)
Linear slides stroke length, in. (mm)	3.5 (90)	3.5 (90)	3.5 (90)	3.5 (90)
Rotary slide setting angle	360°	360°	360°	360°
Weight, excl wire and flux, lbs. (kg)	104 (47)	104 (47)	95 (43)	95 (43)

A6 Mastertrac

Self-Propelled, 4WD, Automatic Tractor

- Self-propelled, 4WD, automatic welding machine
- Quick set-up for different workpieces
- Suitable for heavy production welding with capacity for up to 0.24 in. (6 mm) wire using 1500A direct or alternating current
- Designed for use with LAF (DC), TAF (AC), and ARISTO® 1000 AC/DC welding power sources
- Available for single or twin arc welding:
 - Single: with standard or high speed motor
 - Twin: convert an A6 Single Mastertrac into a highly productive automatic twin arc welder for fillet and butt welds with a simple add-on for the extra wire and without the use of an extra machine or power source
- Weld mild steel and aluminum solid or cored wire by modifying an A6 Single Mastertrac with an easy conversion kit for gas metal arc welding (GMAW)
- Pre-set and control of welding parameters with the A2-A6 PEK process controller - a digital control system with display menus; 255 different weld sets can be stored



Ordering Information

A6 Mastertrac SAW, Single	0461235880
A6 Mastertrac SAW, Single, High Speed.....	0461235890
A6 Mastertrac SAW, Twin	0461235881
A6 Mastertrac SAW, Twin, High Speed	0461235891

Options & Accessories

Heavy-duty twin arc conversion kit	0334291889
Wire reel, plastic, 66 lbs. (30 kg)	0153872880
Wire reel, steel, 66 lbs. (30 kg)	0416492880
Wire reel, steel, flexible width, 66 lbs. (30 kg) ..	0449125880
Wire reel, steel, strip cladding	0671161880

Specifications

A6 Mastertrac	Single SAW	Single GMAW	Twin SAW
Permissible load 100%, A	1500	600	1500
Wire diameter, in. (mm)	1/8-1/4 (3.0-6.0)	1.0-3.2 (0.045-1/8)	2x3/32-1/8 (2x2.0-3.0)
Wire feed speed, ipm (m/min)	8-157.5 (0.2-4.0)	31.5-653.5 (0.8-16.6)	8-157.5 (0.2-4.0)
Wire feed speed high, ipm (m/min)	16-315 (0.4-8.0)	-	16-315 (0.4-8.0)
Travel speed, ipm (m/min)	4-79 (0.1-2.0)	4-79 (0.1-2.0)	4-79 (0.1-2.0)
Control voltage, V AC	42	42	42
Wire reel weight, lbs. (kg)	66 (30)	66 (30)	2x66 (2x30)
Flux hopper capacity, gal. (L)	2.6 (10)	-	2.6 (10)
Weight excl wire and flux, lbs. (kg)	242.5 (110)	220.5 (100)	242.5 (110)

Options & Accessories continued

Heavy-duty brake hub	0146967880
SAW-GMAW conversion kit	0334299910
Strip cladding kit	0155972880
Flux hopper holder for strip cladding	0148107003
Flux recovery nozzle, strip cladding	0156025001
Flux funnel	0254900880
Flux insert	0254900301
Angular slide	0671171580
Laser lamp kit	0821440880
Flux recovery unit OPC	0148140880
Bracket suction	0332947880
Idler rollers (2 per tractor)	0333164880
Guide wheel assembly	0671125780
Magnet guide rail, 10 ft. (3 m)	0154203880
Rebuilding kit	0153592880
VEC-motor, 312:1	0145063905

A2 PEI Process Controller

For Use with ESAB Power Sources and Motors

- Control system for A2 tractors and welding heads
- Analog type that can control most brands of power supplies
- Suitable for submerged arc welding (SAW) or gas metal arc welding (GMAW)
- Travel speed, voltage, and wire feed speed can be adjusted by simply turning the knobs - actual data is shown on digital displays during welding
- Change welding direction using switch on front panel
- Choice of scratch start or direct start methods
- Adjustable burnback time



Ordering Information

A2 PEI process controller..... 0449330880

Options & Accessories

Control cable, 15 m (49 ft.) 0449500880
 Control cable, 25 m (82 ft.) 0449500881
 Control cable, 35 m (115 ft.) 0449500882

Control cable, 50 m (164 ft.) 0449500883
 Control cable, 75 m (246 ft.) 0449500884
 Control cable, 100 m (328 ft.) 0449500885

Specifications

A2 PEI Process Controller	
Connection voltage from the power source	42V AC, 50/60 Hz
Connection power	max 700 VA
Motor connection adjusted for ESAB's A2 motors	42V DC, 3.5 A P100%, 4.5A P60%
Speed control	Internal EMK-adjustment
Welding speed, ipm (m/min)	4-79 (0.1-2.0) depending on travel carriage
Max. transport speed, ipm (m/min)	2.0 (79)
Consumable wire feed speed, ipm (m/min)	20-640 (0.5-16.2) depending on wire feed unit
Burnback time, s	0-2.0
Gas pre-flow time, s	0.5
Gas post-flow time, s	1.0
Connection to power source	Burndy contact, 23 poles
Welding voltage control, V DC	0-10
Flow guard	NO Contact / PNP OC
Limit switches	NO Contact / PNP OC
External current shunt, A/mV	1000/60, 1500/60, 600/100, 750/100
Operating temperature, °F (°C)	14-104 (-10 - +40)
Weight, lbs. (kg)	14 (6.2)
Dimensions LxWxH, in. (mm)	7.8x9.0x8.7 (197x227x220)
Enclosure class	IP 23

A2-A6 PEK Process Controller

For Use with ESAB Power Sources and Motors

- For use with ESAB automatic DC power sources LAF 631/1001/1251/1601, AC power sources TAF 801/1251, and Aristo® 1000 AC/DC power source
- CAN-bus system for data transfer
- Prepared for submerged arc welding (SAW), gas metal arc welding (GMAW), and arc gouging
- User-friendly clear text menus
- Selectable welding process
- Memory for 255 parameter sets
- Constant current or constant wire speed
- Encoder-controlled motors for top performance motion control
- USB port for data back-up and transfer
- Used welding parameters can be stored directly on a USB memory drive
- Documentation of used welding parameters on PC or through LAN with WeldPoint™
- Five “soft keys” can be configured according to operator preferences



Adjustable sun shield for better visibility for outdoor use



Ordering Information

A2-A6 PEK process controller 0460504880

Options & Accessories

I/O-Module 0462080001
 Set of connectors 0462119880
 Cable restraining bracket..... 0460861880

Specifications

A2-A6 PEK Process Controller	
Connection voltage from the power source	42V AC, 50/60 Hz
Connection power	max 900 VA
Motor connection adjusted for ESAB's A2 and A6 motors	connection of 2 motors, motor current 6A cont., max 10A
Speed control	feedback from pulse encoder
Welding speed, ipm (m/min)	4-79 (0.1-2.0) depending on travel carriage
Max. manual travel speed, ipm (m/min)	79 (2.0)
Consumable wire feed speed, ipm (m/min)	12-984 (0.3-25) depending on wire feed unit
Valve output	1 pc, 42 V AC, 0.5A
Inputs	for connection of sensors or limit switches
Connection to power source	Burndy contact 12-poles
Max ambient temperature, °F (°C)	113 (45)
Min ambient temperature, °F (°C)	5 (-15)
Relative humidity (of air)	98%
Dimensions, LxWxH, in. (mm)	7x9.25x11 (246x235x273)
Weight, lbs. (kg)	14.5 (6.6)
Enclosure class	IP 23

LAF 631, 1001, 1251 & 1601

DC power sources for SAW and GMAW

- Three-phase, fan-cooled DC welding power sources for high productivity automated submerged arc welding (SAW) or gas metal arc welding (GMAW)
- Used with ESAB's A2-A6 equipment range and A2-A6 PEK or A2 PEI process controllers
- Good arc stability at both high and low arc voltages
- Adjust and monitor the welding parameters on the power source from the front panel of the PEK or PEI process controller
- Extended welding current by connecting two power sources in parallel for demanding applications
- Power source prepared for communication using most standard protocols like TCP/IP (LAN), CAN or even straight communication with a PLC
- Optional communication modules might be needed depending on the type of protocol used
- Ideal for SAW applications such as windtower components, nuclear power vessels, boilers, and shipbuilding applications
- Ideal for GMAW applications such as welding the root pass in heavy pipe production



Ordering Information

LAF 631	0460512880
LAF 1001	0460513880
LAF 1251	0460514880
LAF 1601	0460515880

Options & Accessories

A2-A6 PEK Process Controller

Control cable, 49 ft. (15 m)	0460910881
Control cable, 82 ft. (25 m)	0460910882
Control cable, 115 ft. (35 m)	0460910883
Control cable, 164 ft. (50 m)	0460910884

A2 PEI Process Controller

Control cable, 49 ft. (15 m)	0449500880
Control cable, 82 ft. (25 m)	0449500881
Control cable, 115 ft. (35 m)	0449500882
Control cable, 164 ft. (50 m)	0449500883
Control cable, 246 ft. (75 m)	0449500884
Control cable, 328 ft. (100 m)	0449500885

Wheel set LAF 631	0457787880
-------------------------	------------



LAF 631, 1001, 1251 & 1601

DC Power Sources for SAW & GMAW

Specifications

	LAF 631	LAF 1001	LAF 1251	LAF 1601
Mains supply: 3 ph, 50 Hz, V 3 ph, 60 Hz, V	400/415 440	400/415/500 400/440/550	400/415/500 400/440/550	400/415/500 400/440/550
Current 100%, 50/60 Hz, A	52	64/64/52	99/99/80	136/136/108
Fuse, slow, 50/60 Hz, A	63	63	100/100/80	160/160/125
Maximum load at: 100% duty cycle, A/V 80% duty cycle, A/V 60% duty cycle, A/V	630/44 - 800/44	800/44 - 1000/44	1250/44 - -	1600/44 - -
Setting range, A/V: GMAW SAW	50/17-630/44 30/21-800/44	50/17-1000/45 40/22-1000/45	60/17-1250/44 40/22-1250/44	- 40/22-1600/46
Open circuit voltage, V	54	52	51	54
Open circuit power, W	150	145	220	220
Efficiency	0.84	0.84	0.87	0.86
Power factor	0.90	0.95	0.92	0.87
Enclosure class	IP23	IP23	IP23	IP23
Dimensions, LxWxH, in. (mm)	26x19x37 (670x490x930)	25x22x43 (646x552x1090)	30.5x23.5x56 (774x598x1428)	30.5x23.5x56 (774x598x1428)
Weight, lbs. (kg)	573 (260)	727.5 (330)	1080 (490)	1290 (585)
Application class	S	S	S	S

S This symbol indicates that the welding power source may be used in areas with an increased electrical hazard, e.g. areas where the electrical hazard is increased due to the proximity to earthed metal objects and/or dampness.

TAF 801 & 1251

Square Wave AC Power Sources for SAW

- Square wave AC power sources that convert the secondary voltage from a sinus wave via a thyristor-controlled rectifier bridge to a square wave arc voltage with excellent strike characteristics and welding properties
- Capacity for continuous welding
- Arc voltage pre-set
- Reliable square wave striking
- Arc voltage or current feedback
- Optimized open circuit voltage
- Compensation of mains supply fluctuation
- Voltage drop compensation for long welding cables
- High power factor ensuring low power consumption
- Safety control voltage, 42V
- Prepared for Scott connection of two power sources
- Used in combination with ESAB's A2-A6 equipment range and the A2-A6 PEK or A2 PEI process controllers
- Power source prepared for communication using most standard protocols like TCP/IP (LAN), Anybus, Profibus, CAN or even straight communication with a PLC



Ordering Information

TAF 801 0460516880
 TAF 1251 0460517880

Options & Accessories

Control cable, 49 ft. (15 m) 0460910881
 Control cable, 82 ft. (25 m) 0460910882
 Control cable, 115 ft. (35 m) 0460910883
 Control cable, 164 ft. (50 m) 0460910884

Specifications

	TAF 801	TAF 1251
Mains supply:		
1ph, 50Hz, V	400/415/500	400/415/500
1ph, 60Hz, V	400/440/550	400/440/550
Maximum load at:		
100% duty cycle, A/V	800/44	1250/44
60% duty cycle, A/V	1000/44	1500/44
Setting range, A/V	300/28-800/44	400/28-1250/44
Open circuit voltage, V	71	72
Open circuit power, W	230	230
Efficiency	0.86	0.86
Power factor	0.75	0.76
Dimensions, LxWxH, in. (mm)	30.5x23.5x56 (774x598x1428)	30.5x23.5x56 (774x598x1428)
Weight, lbs. (kg)	1091 (495)	1340 (608)
Enclosure class	IP 23	IP 23
Application class	S	S

S This symbol indicates that the welding power source may be used in areas with an increased electrical hazard, e.g. areas where the electrical hazard is increased due to the proximity to earthed metal objects and/or dampness.

ARISTO® 1000 AC/DC SAW

AC/DC inverter power source for SAW

- The ARISTO 1000 AC/DC power source is designed to deliver the best submerged arc welding (SAW) performance with the lowest power consumption resulting in more welding per kilowatt hour
- Designed for use with the A2-A6 PEK process controller and the robust A2/A6 feeder units
- A global inverter - connect to a three phase mains supply from 380V to 575V, 50 or 60Hz
- AC settings - Bead Profile Modelling™
- Full control of the settings for AC welding - by controlling the AC frequency, balance and offset, you can optimize the penetration profile, heat input, deposition rate, arc stability, and stirring effect to suit your individual needs
- Change between DC and AC “on the fly” - minimize downtime and weld defects with the push of a button with the patent pending “on the fly” function
- More output - two ARISTO 1000 AC/DC power sources can easily be connected in synchronized parallel mode to deliver more welding current if required
- Designed for heavy-duty industrial environments
- Long welding cables - patent pending Cable Boost™ technology stores energy and instantly delivers up to 450% additional energy when required extending the maximum usable weld cable length by more than a factor of two without compromising the weld result
- Remote-controlled on/off function save energy - multiple power sources in a remote location can be controlled by a remote function and can easily be switched off to save energy
- Power efficiency and less current consumption to reduce your installation and running costs and help to reduce your carbon footprint
- All cables are connected in a cabinet in the front of the machine, easily accessible for service and well protected from damage for uninterrupted welding production
- Ideal for these applications:
 - Windtower structures, nuclear components
 - Beams, bridge components
 - Trailer beams, excavator components
 - Panel lines, sub components
 - General fabrication
 - Single or multi-wire applications



Ordering Information

ARISTO 1000 AC/DC SAW 0462100880

Options & Accessories

A2-A6 PEK process controller 0460504880
 Parallel kit (1 per power source) 0463201882
 Tandem kit (1 per power source) 0463201882
 Interconnecting control cable' 0463282880

'Required for the parallel and tandem kit #0463201882.

Control Cables

Control cable, 49 ft. (15 m) 0460910881
 Control cable, 82 ft. (25 m) 0460910882
 Control cable, 115 ft. (35 m) 0460910883
 Control cable, 164 ft. (50 m) 0460910884



A2-A6 PEK Process Controller

ARISTO® 1000 AC/DC SAW

AC/DC inverter power source for SAW

Storage and documentation compartment

Lifting eyes

Easily accessible, re-usable air filters

Power On/Off/Remote

Control cables separated from mains supply and weld cables

Control cable connectors

Mains power inlet

Weld terminals, no connectors at the rear



- Efficient cooling channel design provides optimal cooling of the machine while all sensitive components are protected from dust and particles
- The cooling channel is easy to clean with compressed air
- Re-usable air filters minimize the amount of particles in the cooling channel

Specifications

ARISTO 1000 AC/DC SAW								
Mains supply, 3ph, 50/60Hz, V	380-575							
Setting range (DC load), A / V	86 / 380	82 / 400	79 / 415	74 / 440	71 / 460	66 / 500	59 / 550	57 / 575
Mains fuse (slow), A / V	100 / 380	100 / 400	80 / 415	80 / 440	80 / 460	80 / 500	63 / 550	63 / 575
Maximum load at 100% duty cycle, A/V	1000 / 44							
Open circuit voltage, V	121							
Open circuit power, W	240							
Efficiency	0.88							
Power factor	0.93							
Dimensions, LxWxH, in. (mm)	34x24x52 (865x610x1320)							
Weight, lbs. (kg)	727.5 (330)							

A2S Mini Master

Multi-purpose welding system

- Versatile welding system for single wire submerged arc welding (SAW), twin wire SAW, or gas metal arc welding (GMAW)
- Lightweight, compact design for greater flexibility
- Modular design allows user to expand, integrate, or modify the system quickly and easily
- Use with A2-A6 PEK or A2 PEI process controller
- Accurate, easy joint-tracking with manual or motorized slide system and manual PAV or automatic GMH joint tracking
- The system attaches to any beam travelling carriage or Column & Boom system



Ordering Information

A2S Mini Master SAW Systems - PEK

Manual slides 3.5x3.5 in. (90x90 mm) 0449170900
 Motorized slides 7x7 in. (180x180 mm), PAV... 0449170901
 Motorized slides 7x7 in. (180x180 mm), GMH. 0449170902

A2S Mini Master SAW Systems - PEI

Manual slides 3.5x3.5 in. (90x90 mm) 0449370880
 Motorized slides 7x7 in. (180x180 mm), PAV... 0449370881
 Motorized slides 7x7 in. (180x180 mm), GMH. 0449370882

A2S Mini Master GMAW MTW (4WD) Systems - PEK

Manual slides 3.5x3.5 in. (90x90 mm) 0449181900
 Motorized slides 7x7 in. (180x180 mm), PAV... 0449181901
 Motorized slides 7x7 in. (180x180 mm), GMH. 0449181902

A2S Mini Master GMAW MTW (4WD) Systems - PEI

Manual slides 3.5x3.5 in. (90x90 mm) 0449380880
 Motorized slides 7x7 in. (180x180 mm), PAV... 0449380881
 Motorized slides 7x7 in. (180x180 mm), GMH. 0449380882

Options & Accessories

Laser lamp kit (for PEK), 6.5 ft. (2 m) cable 0821440880
 Laser lamp kit (for PEK), 23 ft. (7 m) cable 0821440883
 Thin wire straightener, single wire 0332565880
 Thin wire straightener, twin wire 0145787880

Gas Handling Equipment, GMAW Only:

Cooling unit OCE 2H, 220V AC 50/60 Hz 0414191881
 Gas hose..... 0190270101
 Water-cooling hose..... 0190315104
 Arc shield 0334689880

Optional Equipment SAW:

Flux recovery unit OPC 0148140880
 Flux container, silumin alloy 0413315881
 Concentric flux funnel 0145221881
 Contact tube, bent..... 0413511001
 Wire reel, plastic, 66 lbs. (30 kg) 0153872880
 Wire reel, steel, 66 lbs. (30 kg) 0416492880
 Wire reel, steel, flexible width..... 0449125880
 Wire reel, steel, Ø 8.7 in. (220 mm) 0671164080

Conversion kit, SAW to GMAW MTW (4WD)* .. 0461248880

**For A2-A6 PEK process controller.*

Specifications

A2S Mini Master	Single wire SAW	Twin wire SAW	GMAW	GMAW MTW 600w
Wire diameter, in. (mm):				
Steel	1/16-5/32 (1.6-4.0)	2x.045-3/32 (2x1.2-2.5)	.030-1/16 (0.8-1.6)	.040-1/16 (1.0-1.6)
Stainless Steel	1/16-5/32 (1.6-4.0)	-	.030-1/16 (0.8-1.6)	.040-1/16 (1.0-1.6)
Cored wire	1/16-5/32 (1.6-4.0)	-	.045-3/32 (1.2-2.4)	.040-3/32 (1.0-2.4)
Aluminum	-	-	.045-1/16 (1.2-1.6)	.040-5/64 (1.0-2.0)
Max. wire feed speed, ipm (m/min)	354 (9)	354 (9)	630 (16)	984 (25)
Flux hopper capacity, gal. (L)	1.4 (6)	1.4 (6)	-	-
Max. permissible load 100%, A	800	800	600	600
Control voltage, V AC	42	42	42	42
Linear slide stroke length, in. (mm)	3.5 (90)	3.5 (90)	3.5 (90)	3.5 (90)
Rotary slide setting range	360°	360°	360°	360°

A2 Component System Modularization

For PEK and PEI process controllers



A2-A6 PEK Process Controller

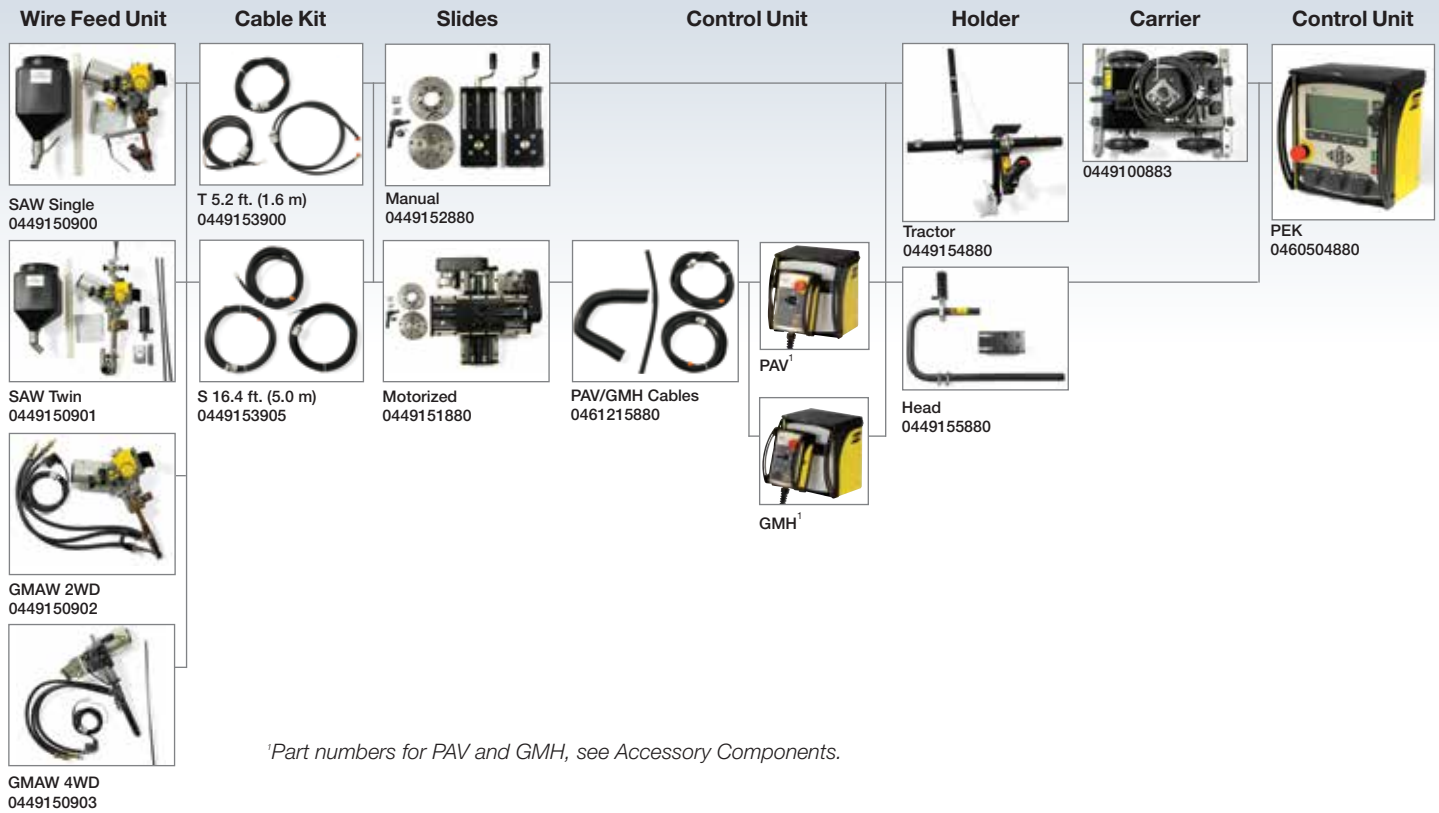

¹Part numbers for PAV and GMH, see Accessory Components.

A2 PEI Process Controller

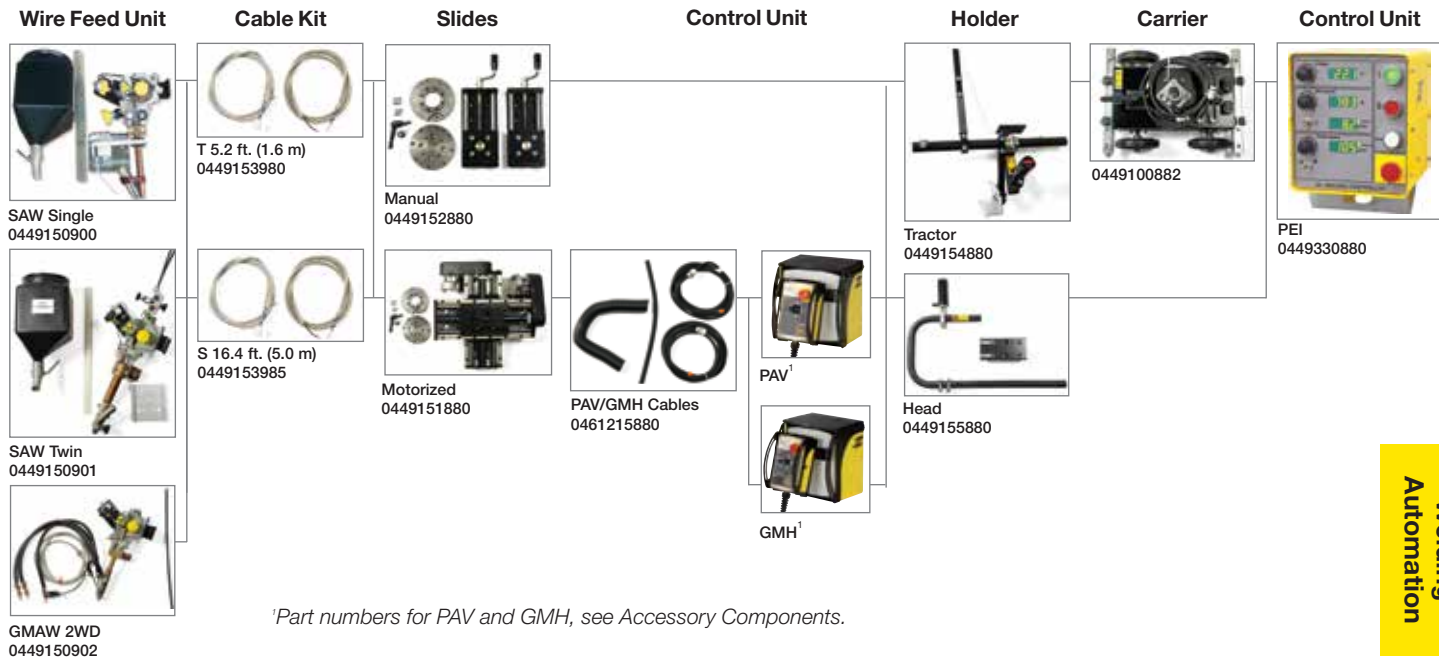

¹Part numbers for PAV and GMH, see Accessory Components.

A6S Arc Master

Modular system for GMAW and SAW

- Comprehensive component and module system make process customization easy
- A6 VEC motor for reliable and consistent wire feed
- Accurate, easy manual PAV or automatic GMH joint tracking with manual slides or joystick-controlled, motor-operated cross slides
- Capable of heavy-duty gas metal arc welding (GMAW), single/twin wire submerged arc welding (SAW), as well as strip cladding, and ICE™ (Integrated Cold Electrode) welding with optional accessories
- Uses A2-A6 PEK process controller for fast, accurate pre-setting of all parameters before welding starts
- Feedback system ensures high and consistent welding quality - saves time and material
- The welding heads can be equipped with a standard wire feed unit (gear ratio 156:1) or with a high-speed wire feed unit (gear ratio 74:1)



A6S Arc Master



A6S Arc Master shown with camera system

Ordering Information

Single Wire SAW Systems

Standard Wire Feed Unit (gear ratio 156:1)

Manual slides 8.3x8.3 in. (210x210 mm) 0449270900
 Motorized slides 11.8x11.8 in. (300x300 mm), PAV ... 0449270901
 Motorized slides 11.8x11.8 in. (300x300 mm), GMH. 0449270902

High-Speed Wire Feed Unit (gear ratio 74:1)

Manual slides 8.3x8.3 in. (210x210 mm) 0449270910
 Motorized slides 11.8x11.8 in. (300x300 mm), PAV ... 0449270911
 Motorized slides 11.8x11.8 in. (300x300 mm), GMH. 0449270912

Twin Wire SAW Systems

High-Speed Wire Feed Unit (gear ratio 74:1)

Manual slides 8.3x8.3 in. (210x210 mm) 0449271910
 Motorized slides 11.8x11.8 in. (300x300 mm), PAV ... 0449271911
 Motorized slides 11.8x11.8 in. (300x300 mm), GMH. 0449271912

Specifications

A6S Arc Master	Ratio 156:1	Ratio 74:1
Max. wire feed speed, ipm (m/min)	8-157 (0.2-4.0)	0.4-8.0 (16-315)
Wire diameter, single, in. (mm)	0.118-0.236 (3.0-6.0)	1.6-4.0 (0.063-0.157)
Wire diameter, twin, in. (mm)	2x0.079-2x0.118 (2x2.0-2x3.0)	2x1.6-2x2.5 (2x0.063-2x0.098)
Tubular wire single, in. (mm)	0.118-0.157 (3.0-4.0)	1.6-4.0 (0.063-0.157)
Linear slide stroke length, in. (mm)	3.5 (90)	3.5 (90)
Rotary slide setting range:		
Circular slide, crank operated	± 180°	± 180°
Straightener	± 45°	± 45°
Max. permissible load, 100%, A	1500	1500

A6 Component System Modularization



A2-A6 PEK Process Controller

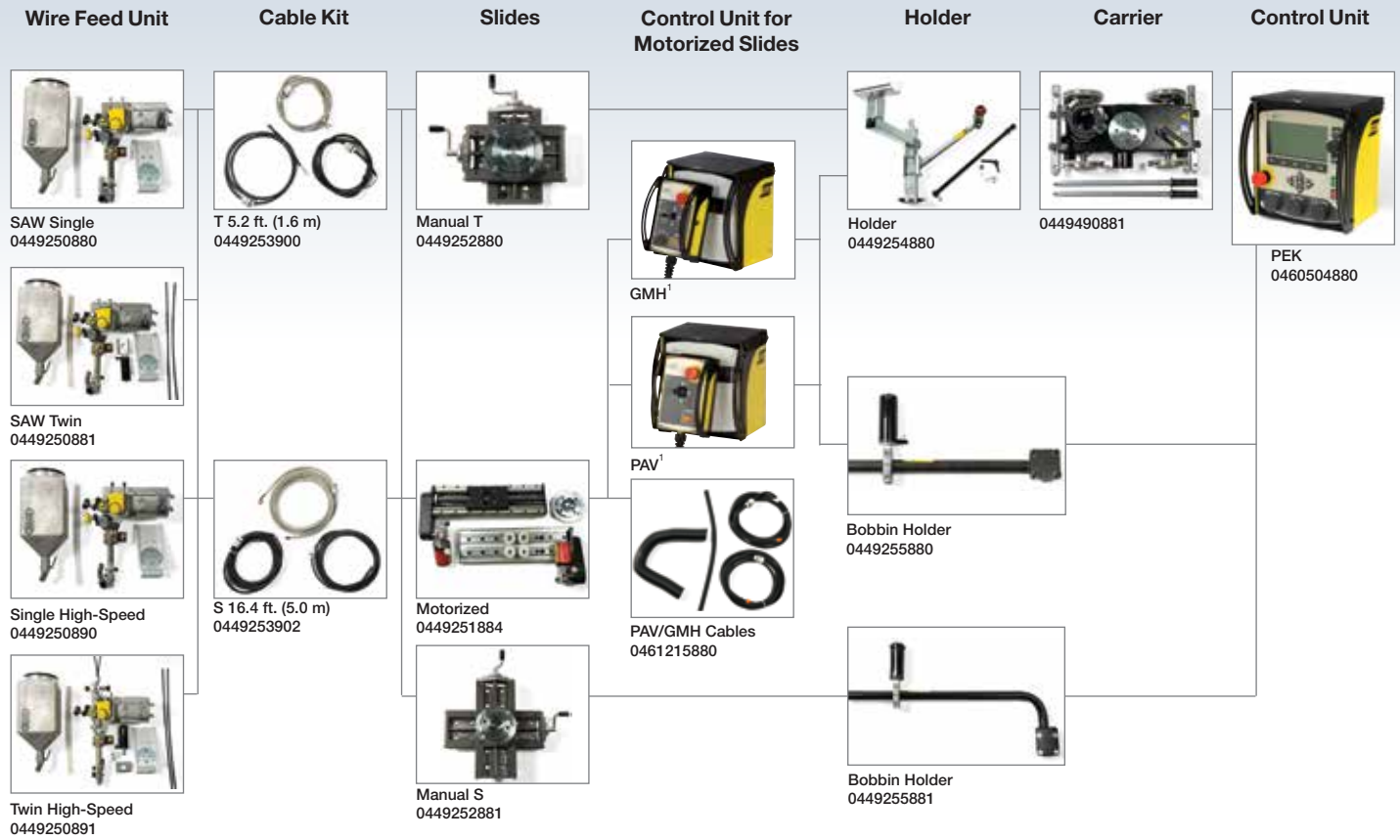

¹Part numbers for PAV and GMH, see Accessory Components.



Unrivaled Service and Support.

Every ESAB product is backed by our commitment to superior customer service and support. Our skilled customer service department is prepared to quickly answer any questions, address problems, and help with maintenance and upgrading of your equipment. Our products are backed with the most comprehensive warranty in the business.

With ESAB, you can be sure that you have purchased equipment that will meet your needs today and in the future. Product and process training is also available. Ask your ESAB sales representative or distributor for a complete ESAB solution.



ESAB Welding & Cutting Products / esabna.com / 1.800.ESAB.123

USA: P.O. Box 100545, 411 South Ebenezer Road, Florence, SC 29501-0545

Canada: 6010 Tomken Road, Mississauga, Ontario L5T-1X9

Mexico: Ave. Diego Díaz de Berlanga, No. 130, Col. Nogalar San Nicolás de los Garza N.L. CP 66480 Monterrey, Mexico

FIND US



facebook.com/esabna



twitter.com/esabna



youtube.com/esabweb



ARC-23000F 11/13