

# Owner's Manual

## TABLE OF CONTENTS

	PAGE
A NOTE ABOUT SAFETY .....	2
GENERAL .....	2
ACCESSORIES .....	3
AUTO START .....	3
ENERGY SAVING RECOMMENDATIONS.....	4
CARE AND MAINTENANCE .....	4
TROUBLESHOOTING.....	6

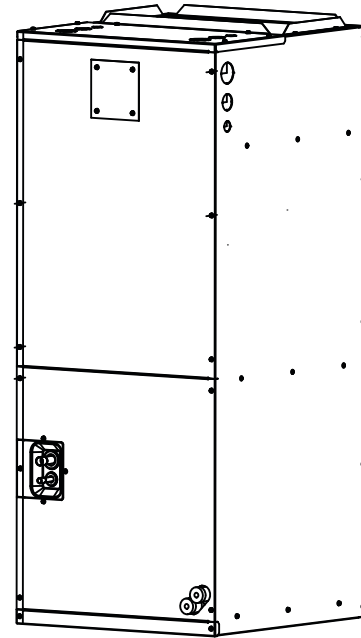

### NOTE TO EQUIPMENT OWNER:

Please read this Owner's Information Manual carefully before installing and using this appliance and keep this manual for future reference.

For your convenience, please record the model and serial numbers of your new equipment in the spaces provided. This information, along with the installation data and dealer contact information, will be helpful should your system require maintenance or service.

#### UNIT INFORMATION

Model # \_\_\_\_\_

Serial # \_\_\_\_\_

#### INSTALLATION INFORMATION

Date Installed \_\_\_\_\_

#### DEALERSHIP CONTACT INFORMATION

Company Name: \_\_\_\_\_

Address: \_\_\_\_\_

Phone Number: \_\_\_\_\_

Technician Name: \_\_\_\_\_

## A NOTE ABOUT SAFETY

Any time you see this symbol  in manuals, instructions and on the unit, be aware of the potential for personal injury. There are 3 levels of precaution:

1. **DANGER** identifies the most serious hazards which will result in severe personal injury or death.
2. **WARNING** signifies hazards that could result in personal injury or death.
3. **CAUTION** is used to identify unsafe practices which could result in minor personal injury or product and property damage.

**NOTE** is used to highlight suggestions which will result in enhanced installation, reliability, or operation.



## WARNING

### PERSONAL INJURY, DEATH AND / OR PROPERTY DAMAGE HAZARD

Failure to follow this warning could result in personal injury, death or property damage.

Improper installation, adjustment, alteration, service, maintenance, or use can cause explosion, fire, electrical shock, or other conditions which may cause personal injury or property damage. Consult a qualified installer, service agency, or your distributor or branch for information or assistance. The qualified installer or service agency must use factory-authorized kits or accessories when modifying this product.

Read and follow all instructions and warnings, including labels shipped with or attached to unit before operating your new air conditioner.

## GENERAL

The Air Handler fan coil unit provides quiet, maximum comfort. In addition to cooling and/or heating, the Air Handler fan coil unit matched with an outdoor condensing unit filters and dehumidifies the air in the room to provide maximum comfort.

**IMPORTANT:** The Air Handler fan coil unit should be installed by authorized personnel only; using approved tubing and accessories. If technical assistance, service or repair is needed, contact the installer.

The Air Handler fan coil unit can be set up and operated from the remote control (provided).

### Operating Modes:

The Air Handler fan coil unit has four operating modes:

- **FAN ONLY**
- **AUTO**
- **HEATING**
- **COOLING**

### FAN ONLY

In the **FAN ONLY** mode, the system filters and circulates the room air without changing room air temperature.

### AUTO

In the **AUTO** mode, the system automatically cools or heats the room according to the user-selected set point.

**NOTE:** **AUTO** mode is recommended for use on single zone applications only. Using Auto changeover on multi-zone applications could set an indoor unit to **STANDBY** mode, indicated with two dashes (--) on the display, which turns off the indoor unit until all the indoor units are in the same mode; either **COOLING** or **HEATING**.

**HEATING** is the system's priority mode.

Simultaneous **HEATING** and **COOLING** is not allowed.

### HEATING

In the **HEATING** mode, the system heats and filters the room air.





### COOLING

In the **COOLING** mode, the system cools, dries and filters the room air.

# ACCESSORIES

The system is shipped with the following accessories (see Table 1). Keep the owner's manual in a safe place and do not discard any accessories until the installation has been completed.

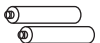
**Table 1 — Accessories**

NAME	SHAPE	QUANTITY
Owner's and Installation Manual (An updated version may be available online)		1
Wireless Remote Controller		1
Battery		1
Infrared Display Panel (located in the Air Handler Unit)		1

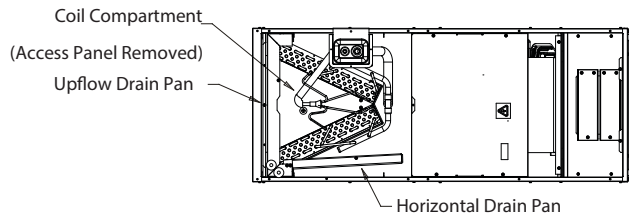
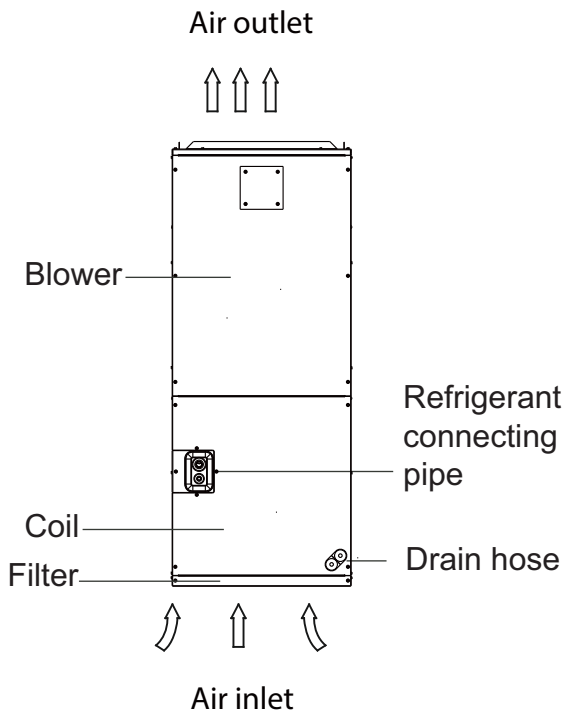

**Fig. 1 — Indoor Unit Representation**

## Wireless Remote Control (Included)

The wireless remote is only to be used by the installation contractor to adjust airflow settings in accordance with static pressure curves in installation manual.

## Built-In 24V Interface Standard

Allows the control of the air handler with a third party thermostat (field supplied).

## DISPLAY PANEL

The Display Panel is shipped inside the Control Box and it is used as an infrared receiver for the wireless remote controller shipped with the unit for the purpose of setting airflow by the installation contractor.

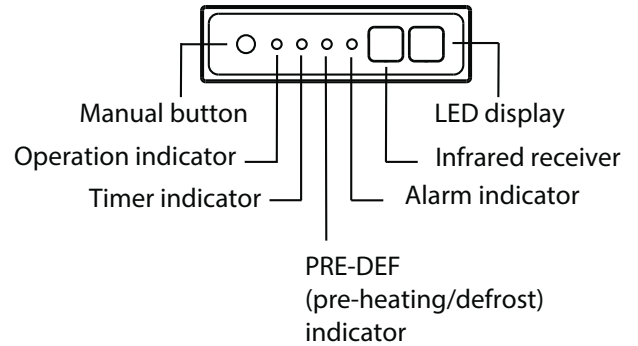

**Fig. 2 — IR (Infrared) Receiver Display Panel**

## AUTO START

If the power fails while the unit is operating, the unit stores the operating condition, and the unit automatically starts operating under those conditions once the power is restored.

## ENERGY SAVING RECOMMENDATIONS

The following recommendations will add greater efficiency to the ductless system:

- Select a comfortable thermostat setting and leave it at chosen setting. Avoid continually raising and lowering the setting.
- Keep the filter clean. Frequent cleaning may be necessary depending on indoor air quality.
- Use drapes, curtains or shades to keep direct sunlight from heating the room on very hot days.
- Limit the unit's run time by using the **TIMER** function.
- Do not obstruct the air intake on the front panel.
- Turn on the air conditioning unit before the indoor air becomes too uncomfortable.
- **DO NOT** set the unit to excessive temperature levels.
- While cooling, close the curtains to avoid direct sunlight.
- Doors and windows should be kept closed to keep cool or warm air in the room.
- **DO NOT** place objects near the air inlet and outlet of the unit.
- Clean the air filter every two weeks.
- Adjust the louvers properly and avoid direct airflow.

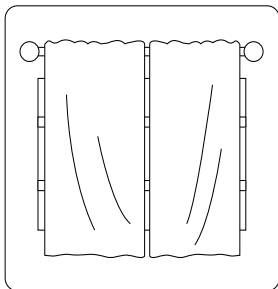

Closing curtains during heating also helps keep the heat in

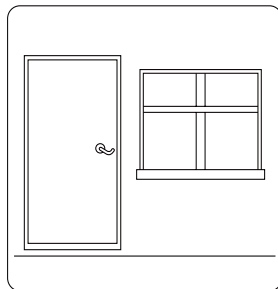

Doors and windows should be kept closed

**Fig. 3 — Close curtains, doors and windows**

## CARE AND MAINTENANCE

### CLEANING YOUR INDOOR UNIT



### CAUTION

#### BEFORE CLEANING OR MAINTAINING THE UNIT

Always turn the unit off and disconnect its power supply before cleaning or maintaining the unit.

When removing filter, do not touch metal parts in the unit. The sharp metal edges can cut.

**DO NOT** use water to clean the inside of the indoor unit. This can destroy insulation and cause an electrical shock.

**DO NOT** expose the filter to direct sunlight when drying. This can shrink the filter.



### CAUTION

Any maintenance and cleaning of outdoor unit should be performed by an authorized dealer or a licensed service provider. Any unit repairs should be performed by an authorized dealer or a licensed service provider.

Contact an authorized service technician for repair or maintenance. Improper repair and maintenance may cause water leakage, electrical shock, or fire and may void your warranty.

**DO NOT** substitute a blown fuse with a higher or lower amperage rating fuse, as this may cause circuit damage or an electrical fire.

Ensure the drain hose is set up according to the instructions. Failure to do so could cause leakage and result in personal property damage, fire and electric shock.

Ensure all wires are connected properly. Failure to connect wires according to instructions can result in electrical shock or fire.



### CAUTION

#### MAINTAINING THE UNIT

Only use a soft, dry cloth to wipe the unit clean. If the unit is especially dirty, you can use a cloth soaked in warm water to wipe it clean.

**DO NOT** use chemicals or chemically treated cloths to clean the unit. **DO NOT** use benzene, paint thinner, polishing powder or other solvents to clean the unit. They can cause the plastic surface to crack or deform.

**DO NOT** use water hotter than 104°F (40°C) to clean the front panel. This can cause the panel to deform or become discolored.

**DO NOT** wash the unit under running water. Doing so creates an electrical hazard. Clean the unit using a damp, lint-free cloth and neutral detergent. Dry the unit with a dry, lint-free cloth.

## CLEANING THE FILTER

The filter prevents dust and other particles from entering the indoor unit. Dust buildup can reduce the efficiency of the air conditioner. For optimum efficiency, clean the air filter every two weeks or more frequently if you live in a dusty area. Replace the filter with a new one if it's heavily clogged and cannot be cleaned.

**NOTE:** In households with animals, you may have to periodically wipe down the grille to prevent animal hair blocking airflow.

1. Remove the filter cover.
2. Remove the air filter.
3. Clean the air filter by vacuuming the surface or washing it in warm water with mild detergent.

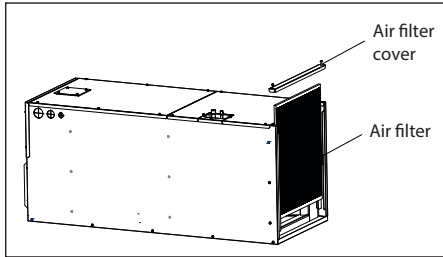

**Fig. 4 — Remove the air filter cover**

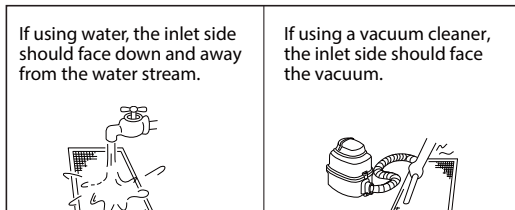
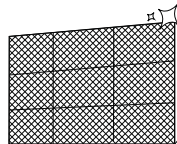

**Fig. 5 — Cleaning filter with water or vacuum**

## MAINTENANCE – LONG PERIODS OF NON-USE

If you plan not to use the air conditioner for an extended period of time, do the following:

1. Clean all filters.



**Fig. 6 — Clean all filters**

2. Turn on the FAN function until the unit dries out completely.

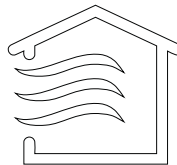

**Fig. 7 — Turn on the FAN function**

3. Turn off the unit and disconnect the power.

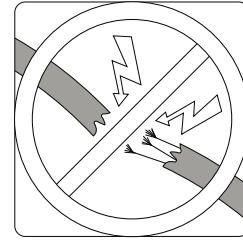

**Fig. 8 — Turn off the unit and disconnect the power**

## MAINTENANCE - PRE-SEASON INSPECTION

After long periods of non-use, or before periods of frequent use, do the following:

1. Check for damaged wires.



**Fig. 9 — Check for damaged wires**

2. Clean all filters

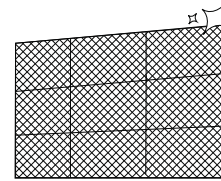

**Fig. 10 — Clean all filters**

3. Check for leaks.



**Fig. 11 — Check for leaks**

4. Ensure nothing is blocking the air inlets and outlets.

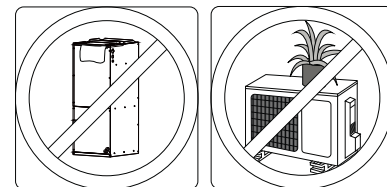

**Fig. 12 — Remove obstacles blocking air inlets/ outlets**

# TROUBLESHOOTING



## WARNING

### SAFETY PRECAUTIONS

If any of the following conditions occurs, turn off the unit immediately!

The power cord is damaged or abnormally warm. You smell a burning odor.

The unit emits loud or abnormal sounds. A power fuse blows or the circuit breaker frequently trips. Water or other objects fall into or out of the unit.

**DO NOT** attempt to fix these issues yourself. Contact an authorized service provider immediately!

The following issues in Table 2 are not malfunctions and in most situations will not require repairs.

**Table 2 — Common Issues**

Issue	Possible Causes
Unit does not turn on when pressing <b>ON/OFF</b>	The unit has a 3-minute protection feature that prevents the unit from overloading. The unit cannot be restarted within three minutes after being turned off.
	<b>COOLING</b> and <b>HEATING</b> models: If the Operation light and <b>PRE-DEF</b> (Pre-heating/ Defrost) indicators are illuminated, the outdoor temperature is too cold and the unit's anti-cold wind is activated to defrost the unit.
	In the <b>COOLING</b> -only models: If the " <b>Fan Only</b> " indicator is illuminated, the outdoor temperature is too cold and the unit's anti-freeze protection activates to defrost the unit.
The unit changes from <b>COOL/HEAT</b> mode to <b>FAN</b> mode	The unit may change its setting to prevent frost from forming on the unit. Once the temperature increases, the unit starts operating in the previously selected mode again.
	The set temperature has been reached, at which point the unit turns off the compressor. The unit continues operating when the temperature fluctuates again.
The indoor unit emits white mist	In humid regions, a large temperature difference between the room's air and the conditioned air can cause white mist.
Both the indoor and outdoor units emit white mist	When the unit restarts in the <b>HEAT</b> mode (after defrosting), white mist may be emit due to moisture generated from the defrosting process.
The indoor unit makes noises	A squeaking sound is heard when the system is <b>OFF</b> or in the <b>COOL</b> mode. The noise is also heard when the drain pump (optional) is operating.
	A squeaking sound may occur after running the unit in the <b>HEAT</b> mode due to expansion and contraction of the unit's plastic parts.
Both the indoor unit and outdoor unit make noises	Low hissing sound during operation: This is normal and is caused by refrigerant gas flowing through both the indoor and outdoor units.
	Low hissing sound when the system starts, has just stopped running, or is defrosting. This noise is normal and is caused by the refrigerant gas stopping or changing direction.
	<b>Squeaking sound:</b> Normal expansion and contraction of plastic and metal parts caused by temperature changes during operation can cause squeaking noises.
The outdoor unit makes noises	The unit makes different sounds based on the current operating mode.
Dust emits from either the indoor or outdoor unit	The unit may accumulate dust after extended periods of non-use. Dust can emit when the unit is turned on. This can be mitigated by covering the unit during long periods of inactivity.
The unit emits a bad odor	The unit may absorb odors from the environment (such as furniture, cooking, cigarettes, etc.) which will emit during operations.
	The unit's filters have become moldy and should be cleaned.
The outdoor unit fan does not operate	During operation, the fan speed is controlled to optimize product operation.

**NOTE:** If an issue persists, contact a local dealer or your nearest customer service center. Provide them with a detailed description of the unit's malfunction as well as the unit's model number.

## TROUBLESHOOTING (CONT)

When issues occur, please review the following common issues in Table 3 prior to contacting a service company.

**Table 3 — Troubleshooting Tips**

<b>Problem</b>	<b>Possible Causes</b>	<b>Solution</b>
Poor Cooling Performance	Temperature setting may be higher than the ambient room temperature	Lower the temperature setting
	The heat exchanger on the indoor or outdoor unit is dirty	Clean the affected heat exchanger
	The air filter is dirty.	Remove the filter and clean it according to instructions
	The air inlet or outlet of either unit is blocked.	Turn the unit to remove the obstruction and turn it back on
	Doors and windows are open	Ensure that all doors and windows are closed while operating the unit
	Excessive heat is generated by sunlight	Close windows and curtains during periods of high heat or bright sunshine
	There are too many heat sources in the room (people, computers, electronics, etc.)	Reduce amount of heat sources
	Low refrigerant due to leak or long-term use	Check for leaks, re-seal if necessary and top off refrigerant
The unit is not working	Power failure	Wait for the power to be restored
	The power is turned off.	Turn on the power
	The fuse is burned out.	Replace the fuse
	The unit's 3-minute protection has been activated.	Wait three minutes after restarting the unit
	Timer is activated	Turn timer off
The unit starts and stops frequently	There is too much or too little refrigerant in the system.	Check for leaks and recharge the system with refrigerant.
	Incompressible gas or moisture has entered the system.	Evacuate and recharge the system with refrigerant
	System circuit is blocked	Determine which circuit is blocked and replace the malfunctioning piece of equipment
	The compressor is broken.	Replace the compressor
	The voltage is too high or too low.	Install a manostat to regulate the voltage
Poor heating performance	The outdoor temperature is extremely low.	Use an auxiliary heating device
	Cold air is entering through doors and windows	Ensure that all doors and windows are closed during use.
	Low refrigerant due to leak or long-term use	Check for leaks, re-seal if necessary and top off refrigerant

